

**PROFILING GROWTH AND FUEL CONSUMPTION
OF MECHANIZED TRAWLERS OF KERALA AND
INVESTIGATIONS ON EFFICIENCY OF LOW DRAG
TRAWL**

*Thesis submitted to the
Cochin University of Science and Technology
in partial fulfillment of the requirements for the award of the degree of
Doctor of Philosophy
in
Fisheries Science
under the Faculty of Marine Sciences*



*Cochin University of Science and Technology
Cochin-682 022, India*

by

Sayana K. A.
(Reg. No. 4283)



**FISHING TECHNOLOGY DIVISION
ICAR-CENTRAL INSTITUTE OF FISHERIES TECHNOLOGY
Indian Council of Agricultural Research
COCHIN-682 029, Kerala, India**



February 2018

Telephone : 0484-2412300
Fax : 0091-484-2668212

www.cift.res.in
E-mail : aris.cift@gmail.com
cift@ciftmail.org



भाकृअनुप - केन्द्रीय मात्स्यकी प्रौद्योगिकी संस्थान
ICAR - CENTRAL INSTITUTE OF FISHERIES TECHNOLOGY
सिफ्ट जंक्शन, विल्लिडन आईलंड, मत्स्यपुरी पी.ओ., कोचिन, - 682 029, केरल, भारत।
CIFT Junction, Willingdon Island, Matsyapuri P.O., Cochin, - 682 029, Kerala, India.
(ISO/IEC 17025: 2005 Accredited & ISO 9001: 2008 Certified)



Certificate

This is to certify that the thesis entitled "Profiling Growth and fuel Consumption of Mechanized Trawlers of Kerala and Investigations on Efficiency of Low drag trawl" submitted by Ms. Sayana K, A. (Reg. No. 4283) is an authentic record of research work carried out by her under my guidance and supervision at ICAR-Central Institute of Fisheries Technology, Kochi, Kerala in partial fulfilment of the requirement for the award of Ph.D. degree under the Faculty of Marine Sciences, Cochin University of Science and Technology, Kochi, Kerala and no part of this has previously formed basis for the award of degree or associateship in any University or Institution. I further certify that all the relevant corrections and modifications suggested by the audience during the pre-synopsis seminar and recommended by the Doctoral Committee of the candidate has been incorporated in the thesis.

Kochi-682 029
February 2018

Dr. M. P. Remesan
(Supervising Guide)
Principal Scientist,
Fishing Technology Division
ICAR-Central institute of Fisheries Technology
Kochi-29, Kerala

Declaration

*I, Sayana K. A., do hereby declare that the thesis entitled "**Profiling Growth and fuel Consumption of Mechanized Trawlers of Kerala and Investigations on Efficiency of Low drag trawl**" is a genuine record of research work carried out by me under the guidance of Dr. M. P. Remesan, Principal Scientist, Fishing Technology Division, ICAR-Central Institute of Fisheries Technology, Kochi, Kerala in partial fulfillment for the award of Ph.D. degree under the Faculty of Marine Sciences, Cochin University of Science and Technology, Kochi, Kerala and no part of the work has previously formed the basis for the award of any degree, diploma, associateship or any other title or recognition from any University/Institution.*

*Kochi-682 018
February 2018*

Sayana K. A.

*Dedicated to the remaining real fishermen
in the world.....*

Acknowledgement

First and foremost I am obliged to the Almighty and convey my reverential salutation for giving me a chance and all the blessings to fulfill my ambition.

I thank my supervising guide Dr. M. P. Remesan, Principal Scientist, Fishing Technology Division, ICAR-CIFT, Kochi for valuable guidance, encouragement and critical assessment of the work,

I whole heartedly express my sincere gratitude to Dr. Leela Edwin, Head, Fishing Technology Division, ICAR-CIFT for her valuable suggestions, encouragement and motivation throughout my research programme. Madam gave me moral support and care to overcome the barriers appeared both in my academic and personal life.

I am grateful to Dr. C. N. Ravishankar, Director, ICAR-CIFT, Kochi and Dr. T. K. Srinivasa Gopal (Former Director ICAR-CIFT) for facilities provided and constant support throughout the entire period of my study.

I owe thanks to Dr. M. Harikrishnan, Director, School of Industrial Fisheries, CUSAT and expert member of my Doctoral committee, for the help rendered whenever I approached him during the research work,

I am grateful to Dr. P. Pravin, ADG, Marine Fishery, ICAR, New Delhi, and Dr. M. R. Boopendranath, Retired Principal Scientist, FT Division, ICAR-CIFT for the constant help they showered during my research period and immense help rendered for my thesis preparation

I acknowledge my sincere thanks to Dr. Saly N. Thomas, Dr. P. Mohamed Ashraf and Dr. V. R. Madhu, Principal Scientists and Mr. M. V. Baiju, Senior Scientist, Fishing Technology Division, ICAR-CIFT, Kochi for the help rendered, fruitful suggestions and valuable contributions whenever required during the research work,

I warmly thank Mr. C. G. Joshy, Scientist, ICAR-CIFT, Kochi for his excellent guidance in statistical analysis.

I sincerely thank Dr. Nikita Gopal, Principal Scientist, Extension, Information and Statistics Division, ICAR-CIFT, Kochi for her timely help and support for economic analysis and suggestions in expressing the results of my study.

A deep sense of gratitude to Dr. Manjulekshmi, Scientist, FT Division, for her timely help and support during preparation of my thesis.

I wish to express my sincere thanks to ICAR - National Agricultural Science Fund (NASF) for providing the fellowship under the project "Green Fishing Systems for Tropical Seas".

I thankfully acknowledge Dean, Faculty of Marine Science, CUSAT for all the support provided in the smooth conduct of my research.

I wish to express my sincere thanks to Office-in-Charge and staff members of CIFT library and Fishing Technology office staff for the help and cooperation extended. I thank all scientists, technical, ministerial and supporting staff, Fishing Technology Division, ICAR-CIFT, Kochi for their great support and assistance.

I am grateful to Skipper and crew of ICAR-CIFT research vessel, R. V. Matsy Kumari II for their whole-hearted cooperation and assistance during field trials.

Thanks are also due to trawl boat owners and fishermen at Shaktihikulangara, Neendakara, Cochin, Munambam, Beypore, Puthiyapa and Chombal for their cooperation and willingness to share the information. Specially mentioning Shri. Sureshbabu, Munambam and Mr. Robinson, Kochi for their wholehearted support during entire study period. Very special thanks to Mr. Afsal, my friend for the support rendered during data collection.

I fondly cherish the love, care and support of my good friends, and colleagues in ICAR-CIFT; Dr. Dhijudas P. H., Mr. Muhammed Sherief, Dr. Renju Ravi, Dr. Vipin P. M., Mr. Sreejith P. T., Mr. Pradip Kumar Mahato, Mr. Rithin Joseph, Mr. Sumith, Mr. Roshan K. A., Mr. James J. P., Ms. Leena Raphael, Ms. Jolsana Jeevan, Ms. Chithrakala, Mr. Vipin Kumar V., Mr. Jinu Krishnan, Mr. Kiran V. R., Mr. Asish H., Mr. Unnikrishnan, Mr. Manuel, Mr. Hari Krishnan, Mr. Antony V. T., Mr. Kiran Jose, Mr. Akhil Sebastian, Ms. Minu P., Ms. Souda V. P., Ms. Archana G., Harsha K, and Ms. Reseena.

The support of my family has been unconditional all these years and without them and their encouragement, support, prayers and understanding it would have been impossible for me to finish this work, I have no words to express my thankfulness to my father, mother and brother for sacrificing a lot for me. Thanks are also due to my son, Rishik for helping me to complete the work without making any hurdles.

Last but not least the supporting pillar of my life, my husband, Mr. Varun V., who gave me helping hand whenever I needed and sacrificed a lot for me. The constant support, love and encouragement he rendered are wordless.

Thanks are also due to all those who have not been mentioned by name but nevertheless have been of invaluable help in their inscrutable ways.

Sayana K. A.

Contents

	<i>Page No.</i>
Chapter 1	
Introduction -----	1
1.1 World marine fisheries-----	1
1.2 Indian marine fisheries -----	3
1.3 Kerala marine fisheries -----	4
1.4 Trawling -----	6
1.5 Consumption and conservation of fuel in trawling----	16
1.6 Economic performance of trawling-----	23
1.7 Low drag trawls -----	26
1.8 Rationale of study -----	35
1.9 Objectives of study-----	37
Chapter 2	
Materials and Methods -----	39
2.1 Area of study-----	39
2.2 Sampling and data collection of commercial trawlers	40
2.2.1 Technical survey -----	40
2.2.2 Data collection on fuel consumption -----	40
2.2.3 Economic survey -----	41
2.3 Experimental fishing -----	43
2.3.1 Experimental vessel -----	43
2.3.2 Trawl nets -----	44
2.3.3 Experimental trials, data collection and analysis -----	44
Chapter 3	
A profile of mechanised trawl fishery of Kerala-----	59
3.1 Introduction -----	59
3.2 Material and methods -----	61
3.3 Results and discussion-----	62
3.3.1 Trawlers -----	62
3.3.2 Trawl nets -----	67

3.3.3 Trawl accessories-----	75
3.3.4 Trawling operation -----	76
3.4 Conclusion -----	78
Chapter 4 Temporal changes in mechanised trawl fishery of Kerala -----	97
4.1 Introduction -----	97
4.2 Material and methods -----	100
4.3 Results and discussion-----	100
4.3.1 Growth in trawlers -----	101
4.3.2 Growth in engine power of trawlers -----	107
4.3.3 Growth in trawl net -----	109
4.3.4 Growth in trawling operation -----	121
4.4 Conclusion -----	122
Chapter 5 Fuel consumption, energy efficiency and environmental burdens of mechanised trawlers -----	125
5.1 Introduction -----	125
5.2 Materials and methods-----	128
5.3 Results and discussion-----	129
5.3.1 Fuel consumption in mechanised trawlers -----	130
5.3.2 Fuel efficiency of mechanised trawlers -----	149
5.3.3 Energy intensity in mechanised trawlers-----	154
5.3.4 Environmental burdens of mechanised trawlers -----	158
5.4 Conclusion -----	161
Chapter 6 Economic performance of mechanised trawlers in Kerala with special emphasis on fuel cost -----	165
6.1 Introduction -----	165
6.2 Material and methods -----	166
6.3 Results and discussion-----	167

6.3.1 Capital investment -----	168
6.3.2 Annual Fixed cost -----	170
6.3.3 Operational cost -----	173
6.3.4 Total annual cost -----	179
6.3.5 Economic efficiency indices -----	180
6.3.6 Role of fuel cost in operational cost and revenue of mechanised trawlers -----	183
6.4 Conclusion -----	187
<i>Chapter 7</i> Investigations on energy conservation in trawling - potential of low drag trawl in fuel consumption and fish capturing -----	189
7.1 Introduction -----	189
7.2 Materials and methods-----	191
7.3 Results and discussion-----	192
7.3.1 Study on drag with emphasis on operational parameters and fuel consumption -----	193
7.3.2 Efficiency of low drag trawl -----	201
7.4 Conclusion -----	210
<i>Chapter 8</i> Summary and Recommendations-----	215
8.1 Summary -----	215
8.2 Recommendations-----	220

List of Tables

<i>No.</i>	<i>Title</i>	<i>Page No.</i>
Table 1.1	Approaches to reduce drag of trawl nets -----	30
Table 2.1	Specifications of R. V. Matsyakumari II-----	43
Table 3.1	Technical specifications of mechanised trawlers of Kerala -----	67
Table 3.2	Technical specifications of different types trawl nets in Kerala coast -----	74
Table.3.3	Profile of trawl nets used by mechanised trawlers in Kerala coast -----	74
Table.4.1	Number of trawlers in Kerala-----	103
Table 4.2	Growth in size of trawlers in Kerala-----	105
Table.4.3	Percentage contribution of different size class -----	107
Table.4.4	Engine power of trawlers along Kerala coast in different years -----	108
Table.4.5	Maximum head rope length of trawl nets used along Kerala coast in different years -----	110
Table.4.6	Mesh size at the wing end of trawl during different years -----	113
Table 5.1	A profile of fishing time of mechanised trawlers in Kerala -----	140
Table 5.2	Profile of fuel consumption (litres) of mechanised trawlers in Kerala (Average is shown in parenthesis)---	142
Table.5.3	Annual fuel consumption of mechanised trawl fishing fleet of Kerala-----	148
Table 5.4	Fuel use intensity of mechanised trawlers (Average is shown in parenthesis) -----	151
Table 5.5	Fuel efficiency in fish capturing of mechanised trawlers (Average is shown in parenthesis)-----	152

Table 5.6	Energy input (per year) and energy intensity of different length class of mechanised trawlers in Kerala for one year (Average is given in parenthesis) --	156
Table 5.7	Average annual carbon emission from mechanised trawlers-----	159
Table 5.8	Carbon emission per kilogram of fish landed from mechanised trawlers (Average is given in parenthesis)-----	160
Table 6.1	Average capital investment for mechanised trawlers in Kerala -----	169
Table.6.2	Annual fixed cost of mechanised trawlers of Kerala ----	172
Table 6.3	Average annual operational cost of mechanised trawlers in Kerala-----	178
Table 6.4	Total annual cost of mechanised trawlers in Kerala-----	179
Table 6.5	Average economic efficiency indices of mechanised trawlers in Kerala-----	183
Table 6.6	Percentage share of fuel cost in operational cost, total cost and revenue of mechanised trawlers -----	186
Table 7.1	ANOVA table of drag and its affecting factors in HDPE trawl using in the experiment -----	194
Table 7.2	ANOVA table of drag and its affecting factors in UHMWPE trawl using in the experiment-----	194
Table 7.3	Average drag of trawl nets in the experiment at different depths -----	194
Table 7.4	Average drag of trawl in the experiment at different warp lengths -----	195
Table 7.5	Average drag obtained at different towing speed for trawl nets used for the experiment -----	198
Table 7.6	ANOVA table on impact of drag on fuel consumption of trawler using HDPE trawl in the experiment -----	200
Table 7.7	ANOVA table on impact of drag on fuel consumption of trawler using UHMWPE trawl in the experiment -----	200
Table 7.8	Average fuel consumption of trawler at different levels of drag -----	200

Table 7.9	Data from GWRL showing twine size of UHMWPE webbing corresponding to PE twines (Source: GWRL, Pune)-----	202
Table 7.10	Empirically estimated twine surface area and drag of trawl nets used for experiment-----	203

List of Figures

<i>No.</i>	<i>Title</i>	<i>Page no.</i>
Fig.1.1	World fish production (Source: FAO, 2016)-----	2
Fig.1.2	Total and marine fish production of India in last decade-----	4
Fig.1.3	Number of marine fishing fleet in India (Source: CMFRI, 2012) -----	4
Fig.1.4	Distribution of mechanised trawlers in maritime states of India-----	15
Fig.1.5	Contribution of mechanised trawlers in marine fish landings of the country -----	16
Fig.1.6	Components of drag of trawl gear -----	28
Fig.2.1	Map of Kerala showing coastal districts and fish landing centres selected for the study -----	42
Fig.2.2	Study area, Cochin (Thopumpady) and Munambam-----	43
Fig.2.3	R. V. Matsyakumari II-----	44
Fig.2.4	Areas covered during trawling experiment-----	45
Fig.2.5	24.0 m UHMWPE trawl net -----	46
Fig.2.6	24.0 m HDPE trawl -----	47
Fig.3.1	Classification of trawl nets of Kerala-----	71
Fig.3.2	145 m Ribbon fish trawl (<i>Thalayan vala</i>) -----	79
Fig.3.3	40.0 m Threadfin trawl (<i>Kilimeen vala</i>) -----	80
Fig.3.4	76.5 m Pomfret trawl (<i>Avoli vala</i>) -----	81
Fig.3.5	81.0 m Mackerel trawl (<i>Ayala vala</i>)-----	82
Fig.3.6	64.0 m Anchovy trawl (<i>Chooda vala</i>)-----	83
Fig.3.7	58.0 m Fish trawl (<i>Meen vala</i>) -----	84
Fig.3.8	39.6 m Flat fish trawl (<i>Manthal vala</i>)-----	85

Fig.3.9	51.0 m Shrimp trawl (<i>Poovalan vala</i>) -----	86
Fig.3.10	34.2 m Shrimp trawl (<i>Karikkadi vala</i>) -----	87
Fig.3.11	58.0 m Shrimp trawl (<i>Naran vala</i>) -----	88
Fig.3.12	40.0 m Deep sea shrimp trawl (<i>Pullan vala</i>) -----	89
Fig.3.13	54.0 m Cuttle fish trawl (<i>Kanava vala</i>) -----	90
Fig.3.14	57.8 m Squid trawl (<i>Koonthal vala</i>) -----	91
Fig.3.15	65.0 m Octopus trawl (<i>Octopus vala</i>) -----	92
Fig.3.16	22.0 m Whelk trawl (<i>Chanku vala</i>) -----	93
Fig.4.1	Percentage share of trawlers in number of mechanised fishing vessels and total fishing fleet of Kerala-----	102
Fig.4.2	Growth in number of trawlers -----	104
Fig.4.3	Growth in length overall of mechanised trawlers -----	105
Fig.4.4	Percentage contribution of different size class of trawlers in Kerala during various years -----	107
Fig.4.5	Growth in engine power of trawlers -----	109
Fig.4.6	Growth in head rope length of trawl nets -----	111
Fig.4.7	Growth in wing end mesh size of the trawl nets -----	113
Fig.4.8	Design of trawl net from Cochin coast in 1993 (Source: Mukundan & Hameed, 1993) -----	114
Fig.4.9	Design of fish trawl along Kerala coast during 1996 (Source: John, 1996) -----	115
Fig.4.10	Design of shrimp trawl along Kerala coast during 1996 (Source: John, 1996) -----	116
Fig.4.11	Design of fish trawl from Cochin during 2008 (Source: Gibinkumar, 2008) -----	117
Fig.4.12	Design of shrimp trawl from Cochin during 2008 (Source: Gibinkumar, 2008) -----	118
Fig.4.13	Design of fish trawl from Kozhikode, Kerala during 2014 (Source: Edwin <i>et al.</i> , 2014a) -----	119

Fig.4.14	Design of shrimp trawl from Kozhikode, Kerala during 2014 (Source: Edwin <i>et al.</i> , 2014a) -----	120
Fig.4.15	Growth in depth of operation of trawlers -----	122
Fig.5.1	Average number of fishing days in a year for selected single-day trawlers during study period-----	131
Fig.5.2	Average fuel consumption per day of selected single-day trawlers during study period -----	131
Fig.5.3	Average number of fishing days in a year of small trawlers (multi-day) during the study period-----	133
Fig.5.4	Average fuel consumption per trip of small trawlers (multi-day) during study period-----	133
Fig.5.5	Number of fishing days in a year of medium trawlers during study period -----	135
Fig.5.6	Fuel consumption per trip of medium trawlers during study period -----	135
Fig. 5.7	Number of fishing days in a year of large trawlers during study period -----	137
Fig.5.8	Fuel consumption per trip of large trawlers during study period -----	137
Fig.5.9	Number of fishing days of very large trawlers during study period -----	139
Fig.5.10	Fuel consumption per trip of very large trawlers during study period -----	139
Fig.5.11	Comparison of fuel consumption per day of single-day and multi-day trawlers (small trawlers) of Kerala [Bar graph shows the average fuel consumption per hour]-----	143
Fig.5.12	Comparison of fuel consumption per hour of single-day and multi-day trawlers (small trawlers) of Kerala [Bar graph shows the average fuel consumption per hour] -----	143
Fig.5.13	Average fuel consumption per day of multi-day mechanised tarawlers -----	144

Fig.5.14	Average fuel consumption per hour of mechanised trawlers -----	145
Fig.5.15	Average fuel consumption per trip of multiday trawlers -----	146
Fig.5.16	Average annual fuel consumption of mechanised trawlers of Kerala -----	146
Fig.5.17	Estimated contribution each length class of mechanised trawlers to the total annual fuel consumption of trawl fishery of Kerala -----	149
Fig.5.18	Average fuel use intensity of mechanised trawlers-----	152
Fig.5.19	Average Fuel efficiency in fish capturing of mechanised trawlers -----	153
Fig.5.20	Energy intensity level of different category of mechanised trawlers in Kerala -----	156
Fig.5.21	Average carbon emission per kilogram of fish landed from mechanised trawlers-----	160
Fig.6.1	Capital investment of mechanised trawlers in Kerala-----	170
Fig.6.2	Share of items of capital investment for mechanised trawlers (steel) in Kerala -----	170
Fig.6.3	Share of items of capital investment for mechanised trawlers (wood) in Kerala -----	170
Fig.6.4	Annual fixed cost of mechanised trawlers in Kerala-----	172
Fig.6.5	Percentage contribution of items of fixed cost to the total-----	173
Fig.6.6	Average annual operational cost of mechanised trawlers in Kerala -----	174
Fig.6.7	Contribution of components to the operational cost -----	174
Fig.6.8	Average annual fuel cost of mechanised trawlers in Kerala -----	175
Fig.6.9	Average annual cost of trawlers incurred for fishermen wages-----	176

Fig.6.10	Average annual cost incurred for repair and maintenance of trawler, engine and trawl nets of mechanised trawlers in Kerala -----	177
Fig.6.11	Average annual expenses incurred for ice, baskets, lubrication oil, landing charges, auction fee and other miscellaneous cost of mechanised trawlers in Kerala-----	178
Fig.6.12	Contribution of fixed cost and operational cost to total annual cost of mechanised trawlers in Kerala-----	179
Fig.6.13	Percentage share of fuel cost to the operational cost, total cost and revenue of mechanised trawlers -----	187
Fig.7.1	Average drag (kN) of trawl nets in the experiment at different depths (m) and its standard error-----	195
Fig.7.2	Average drag of trawl nets in the experiment at different warp lengths and its standard error -----	196
Fig.7.3	Graph showing change in drag (kN) of trawl nets with respect to change in towing speed (kn) of trawler and its standard error-----	198
Fig.7.4	Change in drag and fuel consumption of trawl nets-----	201
Fig.7.5	Average drag of HDPE and UHMWPE trawl in experiment-----	204
Fig. 7.6	Average drag of trawl nets different depth of operation-----	204
Fig.7.7	Average drag of HDPE and UHMWPE trawls at different towing speed -----	205
Fig.7.8	Average drag of HDPE and UHMWPE trawls at different warp lengths -----	205
Fig.7.9	Fuel consumption of UHMWPE and HDPE trawls in experiment-----	208
Fig.7.10	Catch per unit effort of HDPE and UHMWPE trawls in experiment -----	209

|| List of Annexures ||

<i>Annexure</i>	<i>Name</i>	<i>Page No.</i>
I	Trawl fishery survey proforma-----	48
II	Template for trawl designs -----	51
III	Proforma for fuel consumption, operational details and catch of commercial trawlers-----	52
IV	Proforma for investment and yearly expenditure of trawlers -----	53
V	Proforma for experimental trials-----	55
VI	Proforma for warp tension data -----	56

|| List of Plates ||

<i>No.</i>	<i>Title</i>	<i>Page No</i>
Plate 1	Mechanised trawlers, Kerala-----	94
Plate 2	Trawl net and accessories used in mechanized trawlers, Kerala ----	95
Plate 3	Low drag (UHMWPE) trawl-----	212
Plate 4	Different stages of low drag trawl experiment-----	213

1.1. World marine fisheries

Marine capture fisheries is the most diverse among the food producing sectors, both in terms of number of technologies used (Brandt, 2005) and species harvested (Froese & Pauly, 2000). Fisheries is considered as a significant economic activity and a flourishing area with varied resources and potentials. The vibrancy of the sector can be visualized by the four fold increase achieved in fish production in just six decades, i.e. from 25 million tonnes in 1955 to 93.4 million tonnes during 2014 (FAO, 2016) (Fig.1.1). The steady increase in fish production shows importance of the sector in world food supply among which marine fish production constitutes 87% of the total fish production. Fish accounted 17% of animal protein intake in 2013 which is 6.7% of all proteins. Share of world fish production utilised for direct human consumption have risen from 67% in 1960s to 87% in 2014. Remaining 21 mt was destined for non-food products of which 76% was utilized for the production of fish meal and fish oil. Fishery products are the most traded commodity in the world and it is expected to continue (FAO, 2012). World total export value in 2014 is US\$ 18.0 trillion of which amount pertaining to fishery products was US\$ 71869 m (WTO, 2015). World per capita fish supply achieved a record growth and reached 20 kg in 2014. World per capita fish consumption was 9.9 kg in 1960s and 14.4 kg in 1990s which has been raised to 19.7 kg in 2013 (FAO, 2016). The pressure of ever increasing population along with industrialisation and urbanisation resulted in dwindling of land resources in which food resources are affected at a greater level. As 71% of the earth is water

area, best alternate is aquatic resources especially fish. Since time immemorial fishery is recognised as a major source of food security, employment and foreign exchange earnings of many countries including India.

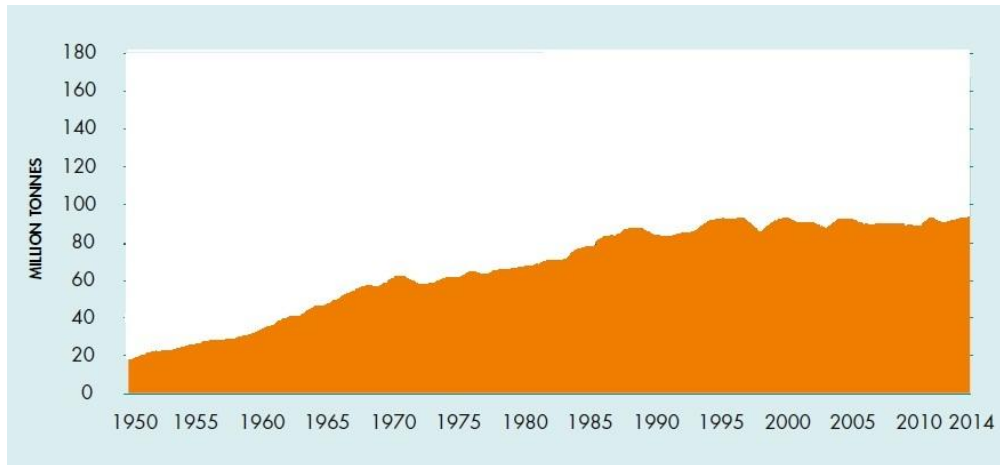

Fig.1.1. World fish production (Source: FAO, 2016)

Fishing is reported as one among the most ancient occupation and as a source of food. Fishing for sustenance has been practiced since the time when hunter-gatherers roamed around the earth thousands of years ago. Fisheries and marine environment support livelihood and aspirations of more than 200 million people in the world. According to recent estimates, fisheries and aquaculture supported livelihoods of 660-820 million people worldwide (FAO, 2012; Suuronen *et al.*, 2012). Estimated amount of fishing vessels in the world in 2014 was 4.6 million in which Asia is contributing 75% followed by Africa (15%), Latin America and the Caribbean (6%), North America (2%) and Europe (2%). Among the total fishing vessels, 64% are engine powered of which 85% comes under 12 m in L_{OA} and 64000 vessels are having L_{OA} more than 24 m (FAO, 2016). Trawling and purse seining are reported to be the most important commercially used fish capturing methods (Sainsbury, 1971). Industrialisation of fisheries sector resulted in excess capacity and over exploitation of most of the fishery resources in the world. Aquatic pollution

especially the plastic debris has ruined the eco-system to a large extent. As a result of these anthropogenic activities, the capture fishery all over the world is showing a declining trend.

1.2. Indian marine fisheries

India with a coastline length of 8129 km and an exclusive economic zone area of 2.02 million km², ranks seventh in global capture fish production and third among Asian countries (FAO, 2016). In India, fisheries together with agriculture has been recognised as an important sector only after the independence. Presently fisheries play a major role among food producing and livelihood providing sectors of the country. The significance of fishery sector in the country is evident from 11-fold increase in fish production in just six decades, that is from 0.75 million tonnes in 1950-51 to 10.16 million tonnes during 2014–15. Marine fish production contributed an average of 40% to the total fish production of the country in last decade (Fig.1.2) (DADF, 2016). Besides meeting the domestic needs, the dependence of over 14.5 million people on fisheries activities for their livelihood and foreign exchange earnings amply justifies the importance of the sector in country's economy and livelihood security. India is home to more than 10 percent of global fish diversity and catchable annual potential yield of the country was 4.42 million tonnes (GOI, 2011). Presently, the country ranks second in the world in total fish production with an annual production of about 10.16 million metric tonnes (DADF, 2016). Total marine fish production in the country was 3.63 million tonnes recording an increment of 6.6% from previous year (CMFRI, 2017) which was only 0.58 million tonnes during 1950s. Out of the total fish production in the country, 52% was constituted by pelagic fish, 29% by demersal fish, 12% by crustacean and 7% by molluscs. Approximate contribution of mechanised, motorised and non-motorised sector in marine

fish production is 82%, 17% and 1% respectively. Estimated number of total fishing vessels in India is 1,99, 141, of which 36.5% are mechanised, 37% are motorised and 26.5% are non-motorised (Fig.1.3).

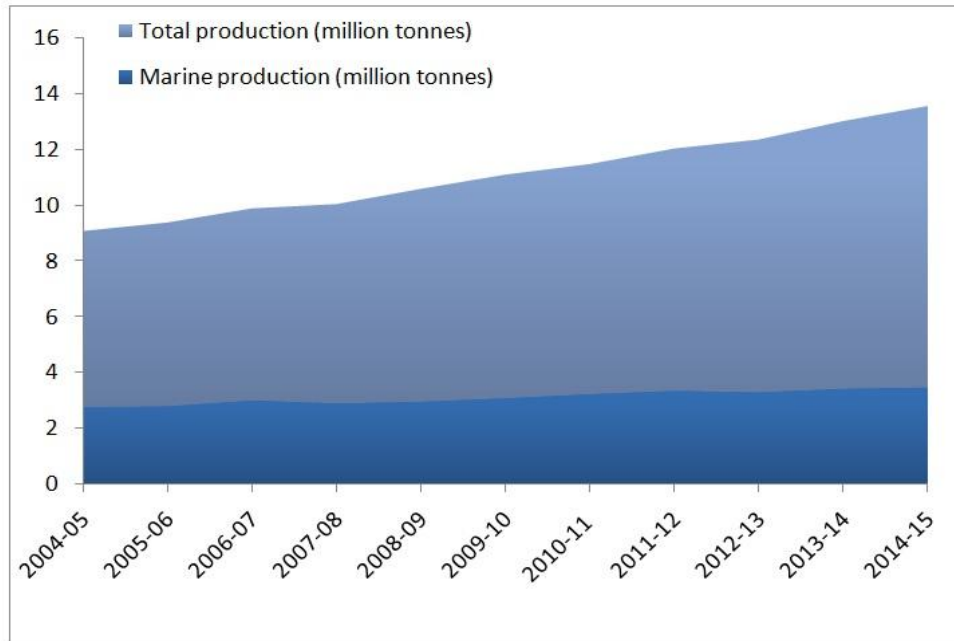

Fig.1.2 Total and marine fish production of India in last decade

(Source: DADF, 2016)

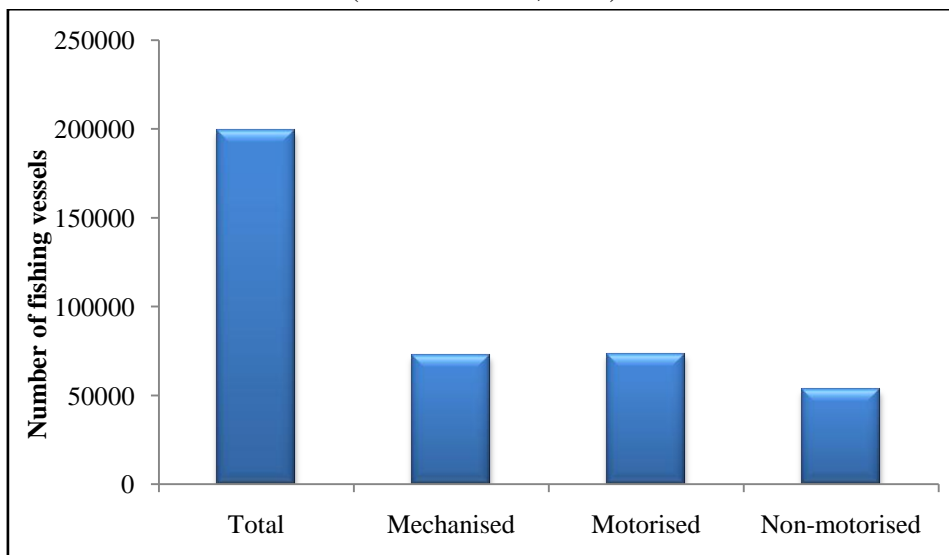

Fig.1.3 Number of marine fishing fleet in India (Source: CMFRI, 2012)

1.3. Marine fisheries of Kerala

Kerala, a green ribbon shaped state, southernmost in Indian sub-continent enthroned with a coastline of 590 km and a continental shelf area of 39,139 sq.kms. Being endowed with the most productive area of Arabian sea, Kerala waters is natural habitat to a wide diversity of tropical marine fauna which include many commercially important fish species. Share of the fishery sector in Agricultural State Domestic Product of Kerala have raised from 5.18 % in eighties to 9.36 % in nineties and thereafter it remained same. The consistent increase in share of fisheries in agricultural and allied sectors over the years establishes the significance of this endemic sector in the state economy. In the state, marine fishery has a prominent role in providing employment, foreign exchange earnings and food security. Fisheries sector contributes significantly to state economy while providing livelihood to approximately 0.61 million people in the state residing in 222 marine fishing villages. The state is occupying fourth position in marine fish production of the country with a production of 5.23 lakh tonnes constituting 14.41% (CMFRI, 2017). Kerala marine fisheries sector is suffering with over exploitation and excess capacity, but it is not reflected in fish production which have raised from 8.72 to 14.41% from 2000-01 to 2016-17. Fisheries contribute 1.04% of gross state domestic product (GSDP) during the year 2015-16 (Economic Review, 2016). Total of 21,781 fishing vessels were there in the state during 2010 out of which 4,722 were mechanised, 11,175 were motorized and non-motorized formed the rest. In the mechanised sector, 78% were trawlers, 10% were ringseiners and 10% were gillnetters (CMFRI, 2012).

1.4. Trawling

A wide array of fishing gears are in use globally ranging from the most traditional hand picking to highly advanced with the aid of modern equipment. The most important and studied among them are trawling, gillnetting, purse seining, lining and traps. Fuel consumption by the fisheries is increasing day by day according to the advancements in fishing gear technology. Hameed & Boopendranath (2000) listed out the most significant development which led to advancements in fishing gear technology as,

1. Developments in craft technology and mechanisation of propulsion, gear and catch handling
2. Introduction of synthetic gear materials
3. Developments in acoustic fish detection and satellite-based remote sensing techniques
4. Advances in electronic navigation and position fixing equipment
5. Awareness of the need for responsible fishing to ensure sustainability of the resources, protection of the biodiversity and environmental safety and energy efficiency

Fishing gears are reviewed and classified by several authors (Andeev, 1962; George, 1971; FAO, 1975&1978, Brandt, 1959&1984; SEAFDEC, 1986, 1989&1995; Ben-Yami, 1994; Sainsbury, 1996; Bjordal & Lokkeborg, 1998; Hameed & Boopendranath, 2000; Misund *et al.*, 2002 and Nedlec, 1982). The prime basis behind the classification of fishing gears is principle of fish capture (Brandt, 1984). In addition, fishing gears can be classified depending on structure, material of fabrication, depth and method of operation,

etc. A scientific classification of fishing gears was first given by Baranov (1933).

Trawling is one of the most important fishing method in the world in terms of fleet size and contribution to the fish production. Trawls being the most common fishing gear numerous studies are conducted on trawls and trawling. Major objective of research in trawl gear is improvement of the gear from the stand point of achieving least resistance with maximum water filtering capacity. Trawls are believed to be evolved from dredge net used in oyster fisheries. Even though bottom trawling is blind trawling, which does not need much instrumentation, it is widely accepted and continuous development over the years is happening (Hanumanthappa, 2009). For capturing demersal populations, trawl is considered as an effective method in terms of yield and investment (Scofield, 1984). Since the known age, fishing was the major occupation of people who lived in the coastal areas and first written evidence on trawling is from early 1300s (Karlsen, 1997). Origin of trawl fishing cannot be isolated, as it coincides with the origin of fisheries and trawlers are known as the “the mother of Deep sea fishing”. Stern trawlers are believed to be introduced in the year 1953 (Warner, 1998) and midwater trawling was believed to be initiated by Germans in 1969 (Wigan, 1998). An early type of fishing trawler called ‘Dogger’ (word originated from Dutch word, Dodger, meaning a fishing vessel which tows a trawl) was developed in Britain during 17th century. The design and influence of the particular wooden boats spread across the world. The evolution of diesel engines and mechanised hauling methods, made the gear larger to improve catching efficiency. Graham (1956) also studied the evolution of trawling. Trawling is listed as the most indiscriminating fishing gear as it captures untargeted and undersized fish (Kelleher, 2005 & Clucas, 1997). Increased landings of trawlers are coming

from higher depths which demand more energy for exploitation which made trawlers more energy intensive.

Trawls provide major portion of world's fish supply (Sainsbury, 1996). Classification and description of trawling was given by Hjul (1972), Nedlec (1982), Brandt (1984), Sainsbury (1996), Hameed & Boopendranath (2000), Sreekrishna & Shenoy (2001) and Meenakumari *et al.* (2009). Based on the position in water column, trawl nets are categorised to bottom and pelagic/midwater trawls (Brandt, 1972). According to the target species, there are fish trawls, shrimp trawls, cephalopod trawls and gastropod trawls. Based on the mouth opening, trawl nets are either beam trawls or otter trawls. According to the number of boats from which the net is operated trawling is categorised into one-boat trawling and two-boat trawling (pair trawling/bull trawling). On the basis of number of trawl nets operated from a single vessel, there are double rig trawl system, triple rig trawl system and quad rig trawl system (Hameed & Boopendranath, 2000).

Trawl is basically a funnel shaped body of netting with sides extending in the front to form wings (to prevent the fish from escaping in front of approaching trawl) and codend where catch is being concentrated (Nedlec, 1982 and Hameed & Boopendranath, 2000). Generally trawls are constructed with two panels of netting, an upper and a lower panel commonly called two seam trawls or four panels an upper, a lower and two side panels commonly called four seam trawls. Cases of six seam, eight seam and other multi seam trawls are also reported in which additional panels are inserted between the top and bottom panels, so that the net body assumes a more favourable shape in terms of filtration and catching efficiency. Trawl body can be divided into different sections such as codend, extension piece, belly, baitings (top belly), square, lower wings and top wings. Bottom trawls usually possess a top

canopy commonly known as ‘square’ or ‘overhang’ extending forward from the top belly to prevent the fish from escaping over the top of the net. Top and bottom panels are attached to head rope and foot rope respectively. Investigations on detailed designs of bottom trawls operated in different trawl fisheries of the world are given by FAO (1975, 1978) and SEAFDEC (1986, 1989 & 1995).

Designing a fishing gear means preparation of technical specifications and drawings to meet the operational necessities of the gear (Fridman, 1986). Design of a fishing gear is the main factor which determines the quality and quantity of catch and fuel consumption which in turn determines the cost of fishing. According to Kunjipalu *et al.* (1993) better fish catching efficiency is a result of design and fabrication method of a gear. Earlier, designing of fishing gear was based on trial and error method, but things have changed and presently empirical and experimental studies are used as an aid in fishing gear designing. The prime basis behind fishing gear design is target fish; biological and behavioural characters and distribution of target species are the parameters which have to be considered while designing a fishing gear. A gear which accomplishes most parameters at most level is to be selected or designed and a fishing gear which is best for all parameters, a universal fishing gear is lacking. Improvements in fishing gear design are identified to make the gear more efficient both in terms of energy and catch. Recently resource conservation, ecological and economic issues became main factors of concern while designing a gear and behavioural studies, engineering studies, model testing, etc are also done while designing. Introduction of synthetic gear materials, onboard gear handling equipment, navigational and fish finding technology made changes in design, construction, operation and efficiency of fishing gears (Boopendranath, 2002). Study on distribution and design of a

fishing gear and its documentation is necessary to make improvements and for innovation of new types of gears. The type and design of fishing gears varies with country and even with regions also. Documentation of a gear design includes its technical details like material of fabrication, size of webbing, twines used, accessories used and its diagrammatic design. Understanding the behaviour of various fish species under different environmental conditions is a key in designing of successful fishing gears (Watson, 1989).

Factors to be considered while designing a trawl net are engine power of vessel, length of belly, head line height, mesh size and its shape, netting material used and the overall resistance (Buckingham, 1972). Trawl net should be designed in the manner that it offers minimum resistance as the quantity of catch in trawl net depends on the amount of water filtered during period of operation (Deshpande, 1960). Behaviour of fish caught, technical characteristics of the vessel and condition of fishing ground are the factors to be considered while designing trawl nets (Sreekrishna & Shenoy, 2001). While talking about the particular case of mid-water trawls, the factors to be considered are high stability, large mouth opening, low turbulence and low drag (Hameed & Boopendranath 2000).

Studies on trawl fishing system are very common around the world; classification, description of structure and evolution of trawl designs had given by Garner (1973, 1977), Nomura & Yamazaki (1975), Nomura (1981), Nedlec (1982), Brandt (1984), Chokesanguan (1985) and Hameed & Boopendranath (2000). Developments in trawling systems had been briefed by Traung (1955, 1960, 1967), Kristjonsson (1959, 1964, 1971) Hjul (1972), Garner (1973), Garner (1977), Ferno & OIsen (1994), Sainsbury (1996) and Hameed & Boopendranath (2000). Valdemarsen & Misund (1995) studied the trawl designs and techniques used by Norwegian research vessels. Use of a 3.0 m

beam trawl for the exploitation of demersal population has been described by Deshpande (1960).

Description of design, operation and economic performance of mini trawls of Cochin and Munambam during 1987-88 has been given by Hameed *et al.* (1989). Nair & George (1964) did survey of different designs of trawls operated Off Cochin. Remesan & Ramachandran (2005) studied and explained mini-trawls with head rope length of 3.5-8 m. Mukundan & Hameed (1993) studied the status of trawl designs from Cochin area.

Choudhury (1973) and Joseph (1985) gave descriptions on desirable parameters of trawlers appropriate for Indian waters. Kartha *et al.* (1990) did survey of different designs of double rig trawls operated from Visakhapatnam. Head rope length of trawls of Thoothukkudi coast has been studied by Neethiselvan & Brucelee (2003) and stated that head rope length of fish trawls ranged from 18 to 32m and for shrimp trawls it was 17 to 32 m. Technical details of trawlers operated in Andhra Pradesh was studied by Jeeva *et al.* (2008). Edwin *et al.* (2014b) reported specifications of trawlers, trawl nets and their operation along Indian coast. Specifications of trawlers, trawl nets and their catch of Andhra Pradesh was studied by Rajeswari *et al.* (2012).

In addition to studies on commercial trawl nets, studies on improvements in trawl designs are also very common. Priour (2009) and Quevedo (2001) worked on improvements in design of trawl nets for increased efficiency. An improved design for mini-trawls suitable for traditional motorised crafts in Kerala was developed based on comparative fishing trials (Vijayan *et al.*, 1990). Accordingly studies were also conducted using designed and developed trawl nets (Narayanappa, 1968; Sreekrishna & Narayanappa, 1970; Satyanarayana & Narayanappa, 1976; Satyanarayana *et*

al., 1972; Deshpande *et al.*, 1970a and Rao & Narayanappa, 1994). Chandrapal (1975) and Miyamoto (1959) studied the relationship between the size of trawler and trawl net. Nair & George (1964) and Panicker *et al.* (1978) also worked on similar aspects.

Several experts have worked on designing and operation of new designs of trawl nets. Shrimp trawls of wider horizontal spread at low towing speed were developed by Satyanarayana *et al.* (1970). Attempts have been made to improve the designs of fish and shrimp trawls of Indian coast by Satyanarayana *et al.* (1985). Effect of overhang on increase in catch in a bulged belly trawl has been studied by Nair *et al.* (1971). A study on comparison of trawl net with overhang and without overhang has been conducted by Mhalathkar *et al.* (1983) and reported overhang trawl to be more efficient to catch off-bottom and column fishes. Higher vertical height is reported for two seam trawls than four seam trawls by Nakamura (1971). But Deshpande *et al.* (1972) reported that four seam trawl had better efficiency in catching off-bottom fishes when compared to high opening bottom trawls (HOBT). A study on optimisation of length of bridle for demersal trawls was conducted by Mohanrajan *et al.* (1990). The role of bridle length has been studied by several experts (Bagenal, 1958; Scharfe, 1959; Chapman, 1964; Crew, 1964; Blaxter *et al.*, 1964; Narayanappa, 1968; Wardle, 1976; Mathai *et al.*, 1984 and Fridman, 1986). Mounsey & Prado (1997) analysed the effect of three different trawls on fishing ground.

A study on comparison of fishing efficiency of bulged belly, long wing and four panel trawl has been carried out by Kunjipalu *et al.* (1979). The results showed that bulged belly trawl is superior over others in catching bottom and column fishes and for shrimps long wing trawls are better. Pillai *et al.* (1979) also reported similar results. Mathai *et al.* (1993) evaluated

efficiency of platform panel as a forward extension of lower belly in semi-pelagic trawls. The superiority of HOBT has been reported by Pajot *et al.* (1982), Pandurangan & Ramamurthy (1983), Brabant & Nedekec (1983), Kunjipalu *et al.* (1984), Mohankrishna (1985), Pajot & Mohapatra (1986) and Raja (1987). Development of high opening trawls was described by Kunjipalu *et al.* (1994).

Vertical opening of the net is a factor in catching efficiency of the net (Takayama & Koyama, 1959 and Parrish, 1959). Studies on vertical mouth opening of trawls have done by Larsson (1952), Barraclough & Jonson (1956), Takayama & Koyama (1959), Okonski & Sadowski (1959), Phillips (1959), Catasta (1959), Benyami (1959), Burgess (1964), Garner (1965 & 1966), Nakasai & Kawakami (1965) and Hunter (1965). The effect of hanging ratio on shape, vertical and horizontal opening and stability have been described by Lonnevik (1989). The use of tickler chain as sinker was reported by Deshpande & George (1965), Beardsley (1973), Anon (1971) and Manoharados *et al.* (1993).

Otterboards are used to provide horizontal mouth opening of trawl nets. They are called as stabilising device for trawl nets and while towing the function is to hold the trawl mouth open (Vijayan *et al.*, 2003). The invention of otterboards made a revolution in one boat trawling. It is the weight of otterboards which make the net sink maximum. Size of otterboards should be matched to the size of trawl net (Ferro, 1981). Many authors conducted studies on various aspects of otterboards including design, type, relationship between otterboard and net dimensions. The effect of weight of otterboard on horizontal opening of the trawl net was studied by Pillai *et al.* (1973). Ben-Yami (1975) explained the optimum size of otterboards to reduce the wastage in towing power for improvements in trawling. Selection of proper size and

shape of otterboards was studied by McLaughlin (1986) and Gabriel (1987). Design and construction of flat rectangular otterboards have been reviewed by Mukundan (1970). Types, design and performance of otterboards are compiled by FAO (1974). Fuel saving by improving design and rigging of otter boards was studied by Seafish *et al.* (1993). Investigations on otterboards and other sheer devices have been conducted by Mukundan *et al.* (1967), Deshpande *et al.* (1970b), Kunjipalu *et al.* (1984) Boopendranath *et al.* (1986), Kunjipalu & Boopendranath (1993), Sahu & Sheshappa (1998) and Shibu & Hameed (1999).

Floats are used on head rope to lift it up to provide vertical mouth opening of the trawl net. Material, shape and diameter of floats are the parameters affecting efficiency of fishing operation. Plastic is the material used for manufacturing of floats and Catasta (1959) also reported use of plastic floats. According to Satyanarayana *et al.* (1970), floats are better to provide vertical opening when compared to triangular gussets or kites. In case of shape, squashed sphere is efficient than spherical floats (Anon, 1973). Significant improvement in total catch especially in finfish was reported by using floats made of canvas (Kunjipalu & Boopendranath, 1993). The use of tickler chain as sinker was reported and studied by several experts (Deshpande & George, 1965; Beardsley, 1973; Anon, 1971 and Manoharados *et al.*, 1993).

Synthetic fibres especially polyethylene is the potential material for trawl webbing. Selection of trawl gear material has been discussed by Mugaas (1959), Klust (1955) and Brandt & Klust (1971). Carrothers (1957) recommended that selection of webbing materials should be based on comparative wet knot strength. Kartha *et al.* (1977) proposed polyethylene as suitable material for trawl net fabrication and stressed on the selection of material with high wet knot strength. Braided polyethylene netting and the

new generation spectra rope give strength and abrasion resistance with long elongation (Stone, 1989). Monofilament twines helps to reduce trawl drag effectively when compared to multifilament twines (Sumpton *et al.*, 1989). Rao *et al.* (1994) found out that substitution of netting material in foreparts of the trawl will help to reduce the drag. Sumpton *et al.* (1989) studied about the bycatch reduction potential of monofilament and multifilament twines and proved that mono filament twines to be better in bycatch reduction.

In India, 18% of marine fishing fleet is mechanised trawlers which constitute almost 49% of mechanised fishing fleet and it is the only fishing system popular in all maritime states (Fig.1.4) (CMFRI, 2012). Fish landing coming from mechanised trawlers constituted an average of 54% of the total landing in the country in the last decade (Fig.1.5) (CMFRI 2008, 2009, 2010, 2011, 2012, 2013, 2014, 2015, 2016, 2017).

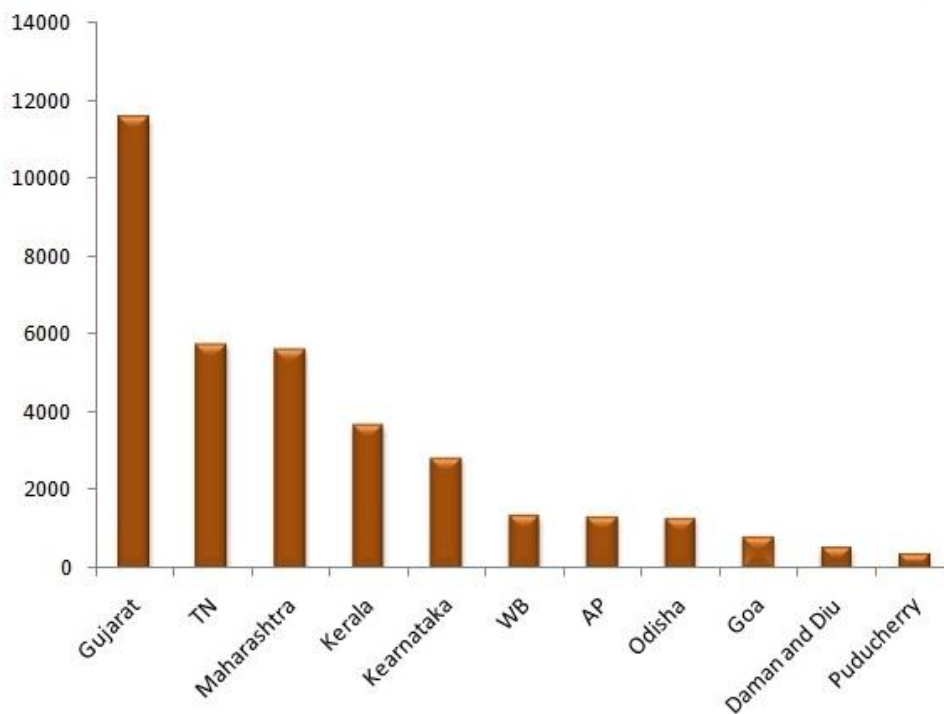

Fig.1.4 Distribution of mechanised trawlers in maritime states of India
(Source: CMFRI, 2012)

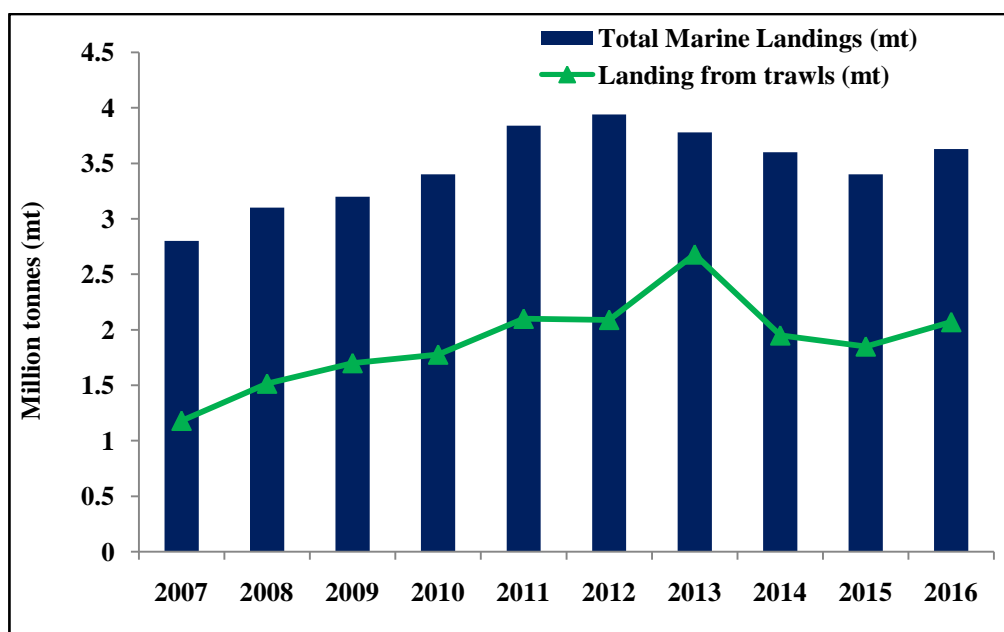

Fig.1.5. Contribution of mechanised trawlers in marine fish landings of the country (Source: CMFRI Annual Reports 2007-08 to 2016-17)

1.5. Consumption and conservation of fuel in trawling

Fisheries, a major food producing sector in the world is facing multiple challenges in the form of sustainability of resources, excess capacity, bycatch and discards, habitat alteration, threat to benthic ecosystem, etc. and recently fuel consumption also joined the list. Mechanised fishing is a fuel dependent industry where fossil fuel is exclusively used source which is limited and non-renewable. Here comes the importance of energy conservation or optimisation in fishing industry or energy efficient fishing. Increased fuel use raises the carbon foot print and green house gas emission which results in global warming, climate change, sea level rise, etc which makes harmful consequences to the earth. Fuel consumption is a problem of prime importance among fishermen apart from its environmental effects (Lee *et al.*, 2010;

Abernethy *et al.*, 2010; Pelletier *et al.*, 2014). Use of fossil fuels in fishery sector has a long history, it is believed to be initiated in England in late 1800s, when coal-fired steam engines were first installed on trawl fishing vessels to provide power for both propulsion and gear operation. Because of its advantages in increment of speed and power, in addition to the ability to operate without considering the wind, trawling expanded rapidly. Accordingly gasoline- and diesel-fueled internal combustion engines were first adopted for use in fishing boats in early 1900s. As consequence of the Second World War over the past 50 years not only the size of the fishing fleet but also the power also has grown drastically (Tyedmers, 2004).

Global proved oil reserve in 2016 is 240.7 billion tonnes which would be sufficient to meet 50.6 years of global production at 2016 levels (BP Statistical Review, 2017). India's oil consumption have grown up to 212.7 million tonnes in 2016 making the country third-largest oil consuming nation in the world (IBEF, 2017). Fishing is one among the most energy intensive way of food production compared to other sectors like agriculture, poultry and dairying.

Trawls are one among the most energy intensive fishing gear in the world and hence numerous studies on energy efficiency in trawling are in progress (Priour, 2009). Highest fuel consumption of trawlers in Norwegian fisheries was reported by Ziegler *et al.* (2012). Compared to passive fishing methods like gill netting and long lining, trawling consumes five times more fuel and it is 11 times more compared to purse seining. To catch one kilogram of fish, trawling requires 0.8 kg of fuel while gillnetting 0.15, long lining 0.25 and purse seining 0.07 kg (Gulbradson, 1986). Endal (1980) stated fuel consumption of different fishing methods as 0.6 -1.0 kg for bottom trawling, 0.2 - 0.3 kg for long lining and 0.1 kg for coastal fishing per kg of fish landed.

Grofit (1981) studied the fuel use in trawling and suggested various measures for making trawling more fuel efficient. Being the most energy intensive fishing system, trawls are the most discussed and studied in the aspect of fuel consumption and optimisation (Gulbrandson, 1986; Hameed & Hridayanathan, 1989; Hameed & Kumar, 1993; John, 1996; John *et al.*, 1998; Nasar, 1998; Boopendranath, 2000; Ravi, 2015; Parker *et al.*, 2015). Parker *et al.* (2015) reported that small pelagic trawl fishery in Australia was more fuel intensive than seine fishing which consume only one third of fuel compared to trawling. There was no significant difference among fuel use of trawlers operating at inshore and offshore areas targeting finfish.

Over exploitation of coastal water resources and advancements in technology compelled the fishermen to go to deeper areas for better catch which intensified the fuel consumption of fishing. Quantification of fuel consumption on a global level has been attempted by Tyedmers (2004), Parker & Tyedmers (2015), Parker *et al.* (2015), Parker & Tyedmers (2015), Tyedmers & Parker (2012), Park *et al.* (2015), Port *et al.* (2016), etc. Annual fuel consumption by fishing industry is estimated at 15-21.5x10⁶ t by Thomson (1988). According to Tyedmers *et al.* (2005), world fishery fuel consumption is 50 billion (5 x 10⁹) litres. Recently Parker & Tyedmers (2015) updated the fuel consumption rate as 639 litres per tonne of fish landed. FAO (2016) estimated global marine fish production as 81.5 million tonnes, hence at the rate of fuel consumption estimated by Parker & Tyedmers (2015) annual fuel consumption of fishing can be estimated to be 52 billion litres. Broad analyses of fisheries fuel consumption exist for North Atlantic fisheries (Tyedmers, 2001), Norway (Schau *et al.*, 2009), Denmark (Thrane, 2004a,b), the European Union (Cheilari *et al.*, 2013), Japan (Watanabe & Okubo, 1989), Taiwan (Hua & Wu, 2011) and global fisheries targeting tunas (Parker *et al.*,

2015). The fuel consumption of mechanised sector is 8-14 times higher than artisanal sector but the fuel consumption per fish produced is lower by a factor of 4-5.

Fuel conservation or energy conservation in fishing is a deeply studied area. Variation in catch relative to fuel consumption among different fishing systems are studied by Nomura (1980). Ratio of input-output calorific value of fuel and power consumption with that of oil, meal and soluble products from Australian coastal whaling operation has been studied by Allen (1981). May *et al.* (1982) addressed the issue of fuel conservation in fish harvesting. Important energy sources for fisheries are listed out by Bardach (1982) and energy alternatives available for fisheries were discussed by Mohanrajan (1987). Energy consumption of coastal fisheries was studied by Ben-Yami (1989) and Hameed & Hridayanathan (1989). Energy inputs to marine fisheries has been studied by Boopendranath (2000), Thrane (2004a,b), Sumaila *et al.* (2008), Winther *et al.* (2009), Abernethy *et al.* (2010), Driscoll & Tyedmers (2010), Vásquez-Rowe *et al.* (2011), Suuronen *et al.* (2012), Tyedmers & Parker (2012). Fuel's share in a fishing system's turnover varies from 10 to over 60% (Priour, 2009) and fuel cost has been increasing by around 8% per year (LeFloc'h *et al.*, 2007). Shibu (1999) reported on the major share of fuel charges to the operational expenditure of fishing systems in Kerala.

Fuel consumption of trawlers which depends on installed engine horse power and duration of voyage constitute 45 to 75% of operational expenditure. Grimaldo *et al.* (2015) compared the fuel consumption of pelagic and semi-pelagic trawls with that of bottom trawls and the results were, fuel consumption of pelagic and semi-pelagic trawls were 5.5% and 17.1% lesser

respectively. According to Unal (2004), fuel consumption in trawl fishing of Foca (Turkey) is 47500 tonnes per year per vessel.

Energy inputs to fishing vessels for production of seafood in US and nutritional outputs were accounted by Rawitscher & Mayer (1977). Variation in catch relative to fuel consumption among different fishing techniques such as tuna long line, salmon drift gillnet, skipjack pole and line, off shore squid angling, purse seine, Alaska pollack trawl and large-scale set net operations were discussed by Nomura (1980). An estimate of the direct and indirect energy inputs in the catch of fish for fish paste products, with respect to Alaska pollack harvest in North Pacific Ocean was given by Watanabe & Uchida (1984). Fuel use intensity in terms of fuel consumption in liters per live weight of fish landed in tonne has been measured in last decade and it showed an increasing trend throughout 1980s and 1990s (Tyedmers, 2001).

Annual fuel consumption by the mechanised and motorised fishing fleet of India has been estimated at 1220 million litres costing over Rs.19000 million annually which formed about 1% of the total fuel consumption in India in 2000. It is estimated to release 3.17 m t of carbon dioxide into the atmosphere at an average rate of 1.13 t of carbon dioxide per ton of live weight of marine fish landed (Boopendranath, 2008). Carbon dioxide release into the atmosphere through the fuel use by Indian marine fisheries was estimated at 3.6 m t at an average rate of 0.5 to 1.02 t of carbon dioxide per ton of live weight of marine fish landed (Vivekanandan *et al.*, 2013). They also reported mechanised trawler as the most carbon emitting fishing system among the mechanised crafts compared to gillnetters, bagnetters, seiners, liners and dolnetters.

Regarding the state of Kerala, Boopendranath (2000) studied the energy requirement in selected fish harvesting systems and concluded that overall fuel consumption for every tonne of fish produced is 0.73-0.86 t. Nasar (1998) estimated the fuel consumption of medium sized trawlers operating from Cochin and redesigning the propeller of these vessels was reported to have benefited a fuel 20 % saving. Aspects of fuel optimisation in trawling operations along Kerala coast has been studied by John (1996) and John *et al.* (1998) and worked out the average yield of fish per litre of diesel consumed by trawlers. Economic aspects of fuel consumption pattern among purse seiners, trawlers and gillnetters operating from Cochin had been discussed by Shibu (1999). Energy Analysis of mini-trawl operations off Cochin and gross energy requirement in fishing operations were studied by Boopendranath & Hameed (2013). Unnithan *et al.* (2005) studied the fuel consumption pattern of mechanised fishing sector of Kerala coast. Fuel consumption pattern by the mechanised fishing sector in Andhra Pradesh was studied by Gopal *et al.* (2008).

Rapid technological advancements incremented the fish landings and it led to over exploitation and sustainability issues in the sector. Apart from the sustainability issues, increased landings are coming from more depths which demand more energy for exploitation. That means energy consumption in the sector increased proportionately with technological advancements. All these necessitate energy conservation or decreased energy consumption in fisheries. Significance of low energy fishing in the context of increased growing energy crisis was analysed by Ben-Yami (1993). Fuel consumption and conservation studies have an initiation since 1970's hike in oil price. Utilization of energy is measured and compared and ways to improve energy use are being investigated in all food producing sectors including fisheries since then (Rawitscher, 1978; Tyedmers, 2004). Issue of fuel conservation in fishing was

addressed by ADB-ICLARM Workshop on Appropriate Technology for Alternative Energy Sources in Fisheries, Manila (Philippines) (May *et. al.*, 1982). One of the pioneer output of these efforts of research during this period was Gerald Leach's handbook "Energy and Food Production" published in 1976. While it dealt primarily with agricultural systems, data on major culturally mediated energy inputs to six fisheries from four continents was included. It is believed as an initiation for research to evaluate and improve energetics of fisheries from a variety of perspectives. Pinhorn (1986) has worked on fuel efficiency aspect of fishing fleet of the Newfoundland. Fuel savings related to modification in trawl design have been studied by Marlen (1989a,b), Rao & Narayanappa (1994), Rao *et al.* (1994), Kwidzinski (1989) and Kunjipalu *et al.* (1989, 1998). In 1988 World Symposium on Fishing gear and Fishing Vessel Design presented and discussed several papers connected to energy optimisation in fishing (Anon, 1989). E-fishing is an international symposium on Fishing Vessel Energy Efficiency where several measures to energy conservation and energy optimization are discussed heavily. The Kyoto Protocol, an international treaty which extends the 1992 United Nations Framework Convention on Climate Change (UNFCCC) that commits participating nations to reduce greenhouse gas emissions, based on the scientific consensus that global warming is occurring and it is human-made CO₂ emissions have predominantly caused it.

Fyson (1982) and Lee & Son (1982) advocated the use of sails in fishing vessels as means of reduced fuel consumption. Gifford (1982) and Jiang (1982) discussed the development of low energy fishing vessels. Energy saving fishing methods suitable for German cutter fisheries operating in Baltic and North Sea such as gill nets, trammel nets and long lines were studied by Steinberg (1985) and Lange (1985). Energy saving measures in trawl design

such as rope trawl have been discussed by Rao & Narayanappa (1994), Rao *et al.* (1994) and large mesh demersal trawls by Kunjipalu *et al.* (1989; 1998), Nayak & Sheshappa (1993) and Manohardoss & Puthra (1998). Another significant measure to reduce fuel use in trawlers is double rig trawling in which two trawls are towed simultaneously from each of the out rigger booms of the vessel which have been studied by Panicker *et al.* (1977) and Kartha *et al.* (1990). Double rig trawling reduces drag to the tune of 25-30 % compared to single trawl at an equal swept area (Anon, 1984a). Rihan (2005) opined that single rig trawling is better in fuel consumption when compared to double rig trawling but compromise is needed in quantity of catch.

1.6. Economic performance of trawlers

Marine fishing is most capital intensive among food producing sectors mainly due to the increased tempo of mechanisation. Fishing either in inshore or off-shore region transformed from a subsistence level to a cash crop operation and presently fishermen are conscious about their profit margin rather than livelihood. Since several technological options are existing for fishermen, it is essential to study the economics of such techniques which would be helpful in their investment decisions. Introduction of bottom trawling to exploit beyond traditional fishing grounds was an important event in marine capture fishery of Kerala. Because of the peaked demand for shrimps in both domestic and international markets, shrimp trawling gained popularity and spread along Kerala coast (Nair, 1999).

Rao (1986) found out that excess concentration of mechanised trawlers resulted in depletion of fish stocks and decrease in productivity and income in Andhra Pradesh fishery. Sehara (1998) evaluated economic efficiency of various types of fishing methods and estimated cost and earnings of different

craft gear combinations of Gujarat and found declining trend in CPUE. Ali (1996) reported inability of trawlers in Paradweep to make profit and the factors behind were heavy repair and replacement charges, growing diesel price, high wages and deteriorating conditions other than stock availability. Sehara *et al.* (1991) and Sehara *et al.* (2000) also did investigations of economic performance of trawlers in India.

Sathiadhas (1998) stated investment for small-scale trawl fishing fleet of Kerala as Rs.18787x10⁶. Economic performance of mini trawls of Cochin and Munambam during 1987-88 was described by Hameed *et al.* (1989). Studies on economics of mini trawls operated in Kerala have been conducted by John (1996). Unnithan *et al.* (1985) and Devaraj & Smita (1988) have worked on the economic feasibility of trawling operation in Kerala. Aswathy *et al.* (2011) estimated the economic viability of mechanised fishing units and socio-economics of fishing ban in the state. Economics of trawlers in the state has been analysed by Sathiadhas & Panikkar (1989), Sathiadhas *et al.* (1992) and Hassan & Sathiadhas (2009). Shanis (2014) investigated the economics of deep sea shrimp trawlers in the state and found out the dominance of fuel cost in operational cost (53-56%). Economics of operation of 17.5 m indigenous steel trawler of Kerala coast has been worked out by Joseph (1973). Iyer *et al.* (1968) studied and compared the relative performance of three different size group trawlers (30ft, 32ft and 36ft) operating along Kerala coast (cochin base) and found that 36ft vessels were much better than the other two categories in efficiency.

Kurien (1985) analysed the impact of Indo Norwegian Project (INP) on Socio Economic Fabric of Kerala Fishery showed that trawl sector has contributed to the growth as well stagnation in Kerala fishery. Rajasenan (1987) constructed fishery production function of Kerala for the year between

1964 and 1984 and found out that there was thirty six fold increase in value of output. Panikkar *et al.* (1991) highlighted the increasing trend of capital intensity of trawl sector in Kerala which is already an excess capitalized sector. Economics of trawlers operated from Neendakara - Shakthikulangara belt of Kollam district and Munambam of Ernakulam district have been studied by Hassan & Sathiadhas (2009) and found out that the annual profit from the trawlers having 9-11.5m L_{OA} engaged in single-day trips as Rs. 10,15,500 per annum and trawlers having 11.7m L_{OA} going for multi day trips as Rs.36,71,160. Kurien & Willman (1982) studied the cost and earnings of 22 combinations of craft and gear in Kerala using the cross section data of 1980-81 fishery and found out that the net profitability of the trawl fishery was negative. Kalawar *et al.* (1985) analysed time series data for the period from 1971-1982 making use of estimated cost and earnings of the trawl fishery and found out that profitability of trawl fishery in Kerala is declining since 1980.

Since all types of fishing operations depend on fossil fuels for propulsion or for gear handling, it became necessary to study the operating cost with emphasis on fuel consumption. Cheilari *et al.* (2013) investigated on the share of fuel cost in operational cost of EU fishing fleet and found out that it was 14% in 2002 regardless the type of fishing and grown over 20% and reached 29% in 2008 and during the period 34.9% of revenue paid for fuel in shrimp trawling. Tulay & Smith (1982) investigated the cost and earnings of mini trawlers operated in Miguel Bay in the Philippines. Share of fuel cost in total cost has also been explained in several studies (Sumaila *et al.*, 2010; Sumaila *et al.*, 2007; CECAF, 1995; Dahou *et al.*, 2001; Reddy, 2004 and FERM, 2004). According to Sumaila *et al.* (2010) fuel cost reached almost 60% of operational cost in Hong Kong and 10-25% in SE Australian trawl fishery. Panayotou *et al.* (1985) presented an interesting work that discusses

socio-economics, cost and earnings, productivity and economic efficiency of small scale fisheries of Asia. Unal (2004) portrays the economics of trawl fishery in Foca (Turkey) and the findings include annual fishing days were 182 days and average fuel consumption was 47500 tonnes per year per vessel. In Kerala fishing sector, Shibu (1999) reported the major contribution of fuel cost to the operational cost of trawlers and diversification of trawlers to liners during off-seasons in Kerala because of decreasing profitability. Panikkar *et al.* (1993) studied economics of different fishing techniques along Kerala coast with special reference to fuel efficiency. Unnithan *et al.* (1985), Sehara & Kanakkan (1993), John (1996), Kurien & Willmann (1982), Kurup & Rajasree (2007), Najmudeen & Sathiadhas (2007), Sehara & Kanakkan (1992), Xavier (2013), John (1996) and Shanis (2014) also worked on economics of trawlers in Kerala.

1.7. Low drag trawls

In the background of steady increase in fuel consumption in fisheries sector it is crucial for harvesters to find ways to save fuel in every possible measure. Fishing gear design has a major role in energy efficiency of fishing and can help in fuel conservation. Drag reduction is identified as one among the significant key in fuel conservation of trawl fishery. In trawling major share of time is spent for towing the gear through water, during which a drag which is a cumulative effect of both vessel and gear is experienced. During towing, the effect of drag due to vessel will be negligible when compared to gear (Boopendranath, 2002). Drag is the power required to overcome the hydrodynamic resistance of the towed gear at a particular speed. The estimation of drag can be done through model studies or using actual gear or can be estimated theoretically (Hameed & Boopendranath, 2000). Drag of

trawls is influenced by together action of factors such as webbing, floats, sinkers, otterboards, warp, bridles and other operational parameters.

Drag experienced during trawling is mostly contributed by the webbing and hence it is assumed that drag of the gear is mainly a function of their twine area. The net alone contributes 50-75% of the total drag (Stewart & McLennan, 1987; Wileman, 1984 and Arkley, 2008). The term net drag means drag due to netting, ground gear (bobbins and foot rope), otter boards, sweeps, warps, floats, etc. Drag depends on many factors such as design of trawl net, rigging, operating conditions such as nature of water currents, depth of operation, length of warp, etc. and drag of each component accounts for the total drag experienced by a trawl net. Wileman (1984) provided the information on component drag of a trawl based on a range of Scandinavian trawls and specified approaches for reducing the trawl drag and fuel consumption. Accordingly warp contribute 5%, sweeps 4%, otterboards 20%, floats 3%, foot rope 10% and netting 58% to the total drag of a trawl (Fig.1.6). A simplified model of the interaction of otter boards and trawl warps with netting drag has been proposed by Prat *et al.* (2008). Tauti (1934) assumed that drag force is proportional to the square of the water velocity. A non-linear relationship between trawl shape and flow velocity with hydrodynamic forces such as drag have been proposed by Balash (2012). According to Morison's equation the drag force is proportional to the flow velocity squared and the cross sectional area of trawl net, provided the drag coefficient is independent of the Reynolds number (Fredsoe & Sumer, 1997). According to Nayak & Seshappa (1993), netting alone contribute more than 80% of the gear drag. Balash (2012) briefed on the parameters affecting drag force of a trawl net as

- netting material;
- netting construction properties (braided or twisted);
- the knot factor (knotted and knotless netting);
- net design (sequence of tapers);
- trawl spread ratio.

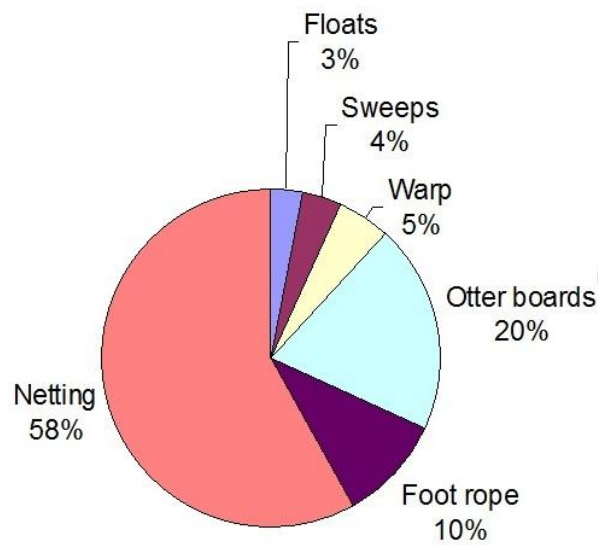

Fig.1.6 Drag of components of a trawl gear

Methods to measure or compute gear performance evaluation have been used by Crewe (1964), Fridman (1969), Anon (1974), Kowalski & Giannotti (1974) and Dickson (1979). According to Balash (2012), the drag is strongly non-linearly related to flexural rigidity of netting. When flexural rigidity increased 16% and 19%, the drag also increased 7% and 20% respectively. Calculation of drag is a complex process, but a simple twine area calculation paves a way to calculate the drag easily and which is relatively accurate. An empirical net drag formula was developed by Mac Lennan (1981) based on the experimental results of 12 four panel high opening demersal trawls suitable for 200 to 2000 hp trawlers. Wakeford (1994) measured the

drag force on four 2 fathom prawn trawl models at flow velocity of 0.75 m/s. Fridman (1986) put forward formulas for calculation of drag of each parts specifically such as netting, floats, sinkers, otterboards, headrope and foot ropes, etc. Fridman & Danilov (1967), Aarsnes *et al.* (1990), Buxton & DeAlteris (1992), Balash *et al.* (2009) and GjØsund & Enerhaug (2010) also worked on similar aspects. Mukundan & Hameed (1995) compared the drag calculated using two formulas and concluded that the formula proposed by Kowalski & Giannotti (1974) is reliable and satisfactory and the results obtained by formula of Dickson (1979) is unreliable and it need further refinement. On the background information that net drag constitute 75% of the total drag, Vijayan & Baiju (2006) estimated the drag of an 18.0 m semi pelagic trawl through calculated twine area in comparison to projected prototype values by model studies. Hanumanthappa & Radcliffe (1998) carried out flume tank experiments and recorded resistance of trawl net at various towing speed.

Drag reduction concept has an initiation in early 1950s in Gulf of Mexico with the concept of multiple rigs (Balash, 2012). Drag reduction is found to be an effective way to reduce fuel consumption of trawlers as 10-20% of fuel is consumed to overcome the drag (Montgomerie, 2009). Wileman (1984) proposed measures to reduce drag of trawls and are given in Table 1.1. Trawl drag can be reduced by reducing the size of trawl, making less opening in wing end spread and head line height, reducing twine surface area, reducing ground contact friction or using more efficient otterboards. Material of fabrication of webbing has significant effect on resistance, efficiency and selectivity of gears. Ward *et al.* (2005) suggested material and twine diameter as the measures need to be changed to improve energy efficiency and also studied the use of knotless netting. According to them reduced twine size

resulted in 6% reduction in drag and 10% increase in mouth opening. Alterations in rigging such as number and length of bridles, floats and sinkers may also affect the drag and improvements can be done in those sections also. Several experts have worked on optimisation of trawl design (Ferro, 1988; Theret, 1993; Bessonneau & Marichal, 1998; Niedzwiedz & Hopp, 1998; Tsukrov *et al.*, 2003; Le Dret *et al.*, 2004; Lee *et al.*, 2005 and Priour, 2009).

Table 1.1 Approaches to reduce drag of trawl nets

Approaches to fuel saving	Reduction in total drag in percentage
Use of knotless netting	7
Use of thinner twine	7
Use of large meshes	7
Use of cambered otter boards	4
Optimal angle of attack of otter boards	4
Use of slotted otter boards	2
Use of multi-rig trawling	25-30
Use of pair trawling	30-35

Source: Wileman (1984); The Oilfish project (1981-84), Nordforsk

Netting is the largest contributor to the drag and hence it is directly related to the amount of netting material. Increasing the mesh size and reducing the twine area is supposed to reduce the drag (Prado, 1977 and Fujishi, 1985). Wileman (1984) explained that use of thinner twine and large mesh in the upper trawl sections, have been individually found to reduce netting resistance by 12 % and total resistance of trawl by 7 %. Tait (2001) compared the drag and fishing performance of trawl made of regular braided polyethylene twine and trawl constructed with high tenacity braided polyethylene twine and found out that the net drag reduced by about 11%. The use of synthetic Ultra high Molecular Weight Polyethylene (UHMWPE) has

proved its role in drag reduction. UHMWPE is a netting material which is stronger and thinner and with very low elasticity (Hansen & TØrring, 2012). It allows the use of thinner materials than the traditional materials which help to reduce drag. DuPont (DSM) Company in 1979 patented a gel spinning technology for polyethylene (PE) fibre manufacture and the material used was ultra high molecular weight polyethylene. The application of UHMWPE material started in 1990s and application of UHMWPE in trawl manufacturing and rigging started in 1994 by Department of Fishing Techniques, Agricultural University of Szczecin. Application of new generation materials including UHMWPE in manufacturing fishing gears especially trawls have been reported by Swiniarsk *et al.* (1995). Their properties like high breaking strength helps in reducing drag and thereby increasing the gear size. Sendlak *et al.* (2001) studied and reported UHMWPE as an alternative material for fishing gear fabrication in view of reducing drag and thereby cost. He also reported that breaking strength of UHMWPE twines are 34 times higher than that of PA netting but the cost is higher. For large sized trawls use of UHMWPE material in front parts has been reported and a 22% reduction in twine area and for small boat trawling with a replacement of 65% of PA material resulted 21% reduction in drag. Balash & Sterling (2014) used UHMWPE webbing as a measure to reduce drag of the netting and results showed that twine are of similar or greater breaking strength to traditional material, but thinner twine (by ~40%) results in decreased drag (by ~22%) for the correctly matched high strength netting and otter boards.

Hansen & TØrring (2012) used 1.4 mm UHMWPE webbing in entire trawl except codend and assured that drag has been reduced. The reason not to use UHMWPE in codend was, its contribution to drag is marginal and thicker larger twine gives a larger spreading effect. UHMWPE is a soft material due

to its multi filament structure and small diameter which will result in complications during operation. This softness and expense is the factor which pulls it back from commercial use; but this softness can be overcome by some chemical or heat treatment. They also used warps made of UHMWPE and stated that profitability of bottom trawling improved by 40%. Lowe (1996) compared drag saving potential of spectra netting with polyethylene netting prawn trawls and the result showed that spectra netting has higher breaking strength; 49% thinner spectra material twine gives similar breaking strength of usual polyethylene netting. Balash *et al.* (2009) also studied the drag of plane netting material and similar tendency was observed. Balash (2012) used Hampidjan material (UHMWPE) and the results showed that it is providing a low drag performance even if a double knot is used. Sendlak *et al.* (2001) reported successful use of UHMWPE warps instead of steel wire ropes and showed 64% drag reduction. Montgomerie (2009) also used UHMWPE webbing for reducing drag.

Initially gear experts believed that reduction in twine area by 50% will result in 50% reduction in drag. Influence of reduction in twine diameter on catch and bycatch in Gulf St. Vincent, Australia was investigated by Broadhurst *et al.* (2000). But, the fact is that the angle to the flow is less in aft parts compared to wing part and the reduction has no linear relation with twine area reduction (Balash, 2012). Use of double rig trawling and pair trawling has been found to reduce trawl drag by 25-30 % and 30-35 % respectively compared to conventional trawl (Anon, 1984b). Tait (1989) found that knotless netting facilitate about 12 % reduction in trawl drag compared to knotted netting.

Studies on drag reduction using large mesh netting in trawls have been studied since 1970s (Priour, 2009). Fiorentini & Cosimi (1987) proved that

reducing twine surface area by using larger meshes at the forepart (wings and square) can reduce net drag without affecting net mouth area. Nayak & Seshappa (1993) studied the effect of large mesh on energy conservation and proved that incorporation of large mesh reduces the drag considerably by 33-34% and thereby fuel consumption. Vijayan *et al.* (1992) proved that midwater trawls with large mesh are more efficient in terms of catch and they also proved that there is a reduction in tension offered by the gear. The catch quantity can be increased by using larger nets but it may increase the drag of the net and also difficulty in gear handling (Dickson, 1959). High opening bottom trawls with large mesh opening reduces drag and gives more mouth area (Buckingham, 1972). The effect of increased mesh size is studied by Naidu *et al.* (1987) and found that it gives more horizontal spread, reduces drag and thus save fuel. Lower resistance for large mesh trawl is reported by Nayak (1991) and Manikandan (2005). Parente *et al.* (2008) used large meshes in bottom trawls and decreased fuel consumption by 18% and increased in cash flow upto 27%. Influence of increasing mesh size on catch and bycatch have been investigated by Broadhurst *et al.* (2000) in Gulf St. Vincent, Australia and found out that increase in mesh size is the main factor influencing the reduction of bycatch.

A pleated panel trawl depicted by Wray (1990) with square mesh orientation in the side sections is a tool in drag reduction. Balash *et al.* (2015) studied the effect of mesh orientation in combination with modification in design of the net. The results showed that 'W' design accompanying T0 meshes redirected 40 to 50% of the drag to tongue portion of the net. Multiple rigs are another way to reduce drag. Multi rig trawling in otter trawls is believed to began in shrimp fisheries in Gulf of Mexico (Balash & Sterling, 2012). Experiments using a triple rig trawl has been conducted by Sterling

(1998) and the results showed that a 50% reduction in drag is possible by triple rig. Twine area reduction is the core in using triple rig. Drag experienced to otterboards can be reduced by lifting them away from the bottom; the raised or fly doors reduce the drag. Hansen & TØrring (2012) proved that UHMWPE warps along with flying pelagic doors and innovative design improved the energy efficiency of trawl system by 40%. According to Wray (1986), design of more efficient otter boards is a way for reduction of net drag and FAO (1974) also mentioned the role of otterboard in reduction of net drag.

Another way to reduce drag is double-tongue trawl design newly which has been recommended (Sterling & Eayrs, 2010). Some commercial trawlers in Australia are using this design in which there is a tendency to concentrate the tension towards the tongue and relieve the load on otter boards. A long narrow shaped net is found to have lower drag when compared to a broad barrel shaped net (Prado, 1977). Charles (1986) conducted an experiment by joining two small nets side by side, head rope and foot rope shared together and used a single pair of otter boards. The results showed that resistance while towing is lower when compared to the resistance of the nets towed separately for the same amount of catch. Parallel twin body trawl and bulged belly trawl are compared together and the results showed that the former had about 28% higher catch rate, 20% increase in horizontal spread and 9% reduction in drag when compared to bulged belly trawl (Panicker *et al.*, 1977).

According to Baranov (1960), knots have a negligibly small effect on drag. An average 12% reduction in drag was observed in knotless netting (Tait, 1987). Balash (2012) conducted studies on the effect of knot on drag and stated that a double knot material increased the drag by 10% compared to knotless or single knotted materials. Montgomerie (2009) used knotless netting and proved 35% reduction in twine surface area.

Mesh orientation and shape can also play an important role in reducing the trawl drag. According to Moderhak (2010), T90 mesh was developed at the Sea Fisheries Institute in Gdynia, Poland in 1990s. According to Hansen (2004), T90 mesh gives 10-12 times larger cross section area compared to similar size normal T0 mesh. Hansen & TØrring (2012) also conducted fishing trials using T90 mesh. The mesh opening has been increased by using T90 mesh, compared to traditional T0 mesh and it made benefit to use less netting material and thereby reducing drag (Arkley, 2008). Initially T90 mesh was used to stabilise the codend and to improve the catch quality (Digre *et al.*, 2010) but it also showed benefit in escapement of smaller fishes (Hansen, 2004). Drag of square mesh (T45) is significantly higher when compared to diamond (T0) mesh (Stewart & Ferro, 1987).

1.8. Rationale of the study

Information provided on trawl fishery of Kerala offer a well grounded basis for planning and execution of development programmes including technical development and in assessing their economic and social impact. They can also help in providing a sound basis for policy formulation, design and execution of measures like credit schemes and subsidies. Conclusions generated are relevant to fisheries management as they may reveal those areas where the need for introducing fishery management is most urgent; they may also provide useful indications of likely future needs for management measures arising from improvements in technology. The urgent need of analysis on present scenario, fuel use and economics to strengthen and promote developments in fisheries had been expressed many times by governments and international funding organizations. Growth in number, size and engine power of trawlers and trawl net size resulted in excess capacity in

trawl fishing sector of the state. Efforts are made to delineate the fuel consumption and cost of fishing in trawl fishery of Kerala. Profile of growth and fuel consumption is a pre requisite in scientific management of the fishery. Energy optimisation in fishing is a major aspect of responsible fishing as enunciated in the Code of Conduct for Responsible Fisheries (FAO, 1995). Efficient use of energy helps in reducing operational costs and environmental impact, while increasing profits. The role of fuel in fisheries field is important and so far noticed issue in natural resource, food and trading policies. While specific aspects of fuel use and cost have periodically concerned the fishing industry and its policy and management agents, the strategic issues of these have been relatively unquestioned until recently. However, in the midst of growing concern for rationalisation of fisheries management, for energy and greenhouse gas linkages in climate change mitigation, for competitive options for smaller scale producers and for consumer appreciation of the environmental footprint of food choices, these issues deserve further exploration. The thesis reveals the utilization of fuel by the mechanised trawling sector of Kerala based on the data obtained from 40 mechanised trawlers of Ernakulam district. The study would be helpful to entrepreneurs for necessary information to invest in trawlers. Details on economic performance of trawlers would help financial institutions in extending credit to the entrepreneurs. It would also be helpful to people who are associated with formulation of fishery development programmes for the region. Increment in fuel efficiency of fishing especially trawlers in times of high fuel prices would be beneficial to fishing fleets. The study using UHMWPE webbing is a first time of this kind in our region which is well established in foreign countries like Australia. Low drag trawls with better fuel efficiency and less CO₂ emission pave way for green fisheries. The study gives

an overall idea about the fuel efficiency and improvement in capturing efficiency of low drag trawl, which can be adopted for improvements in economics of commercial fishery.

1.9. Objectives of the study

1. to profile the mechanised trawl fishery of Kerala
2. to investigate the growth and structural changes in the mechanised trawl fishery sector of Kerala
3. to estimate the fuel consumption, fuel efficiency and carbon emission of commercial trawlers
4. to delineate the economic performance of mechanised trawlers in Kerala
5. to study the drag of trawl nets
6. to assess the fuel consumption and capturing efficiency of low drag trawl

...❦...

MATERIALS AND METHODS

2.1 Area of study

An extensive survey was conducted along trawl landing centres of Kerala to collect data on technical specifications of trawlers, trawl nets and operation. Specific aim of the effort was to make a profile of trawl fishery of Kerala and data collection centres were selected based on the number of mechanised trawlers distributed. According to available estimates, 80% of the mechanised trawlers in Kerala are located in Kollam, Ernakulam and Calicut districts. Centres selected for the study are Sakthikulangara and Neendakara of Kollam district; Cochin (Thopumpady), Murikkumpadam, Kalamukku and Munambam of Ernakulam district; Beypore, Puthiyapa and Chombal of Kozhikode district and Thaikkadapuram and Cheruvathur of Kasargod district (Fig.2.1).

Seven centres including five major harbours were selected for collecting data on economic performance of trawlers. Selected centres are Sakthikulangara, Neendakara, Cochin, Munambam, Beypore, Puthiyapa and Chombal (Fig.2.1).

Data regarding fuel consumption and operational details of trawlers were collected from 40 selected trawlers of Cochin and Munambam harbours (Fig.2.2) using pre-tested schedule.

Experimental fishing trials were conducted in off Cochin region, a commercial fishing ground (Fig.2.4). The coordinate of the area ranged from 09°54' N76°05' E to 10°59' N76°10' E.

2.2 Sampling and data collection of commercial trawlers

2.2.1 Technical survey

Data on technical specifications of trawlers, engine, trawl nets, operation and other relevant information were collected from fishermen, net makers and other stakeholders. Data were collected during 2012-13 and information have been updated during 2016-17 and visiting the field and interviewing fishermen was the method adopted. A well structured and pre-tested questionnaire and template was used for collecting data which is given as Annexure I and II respectively. Samples representing each category of trawlers and gears were collected from every centres. Secondary data for the support of study was collected from CMFRI Marine Fisheries Census 2010, Fisheries Departments, Fishermen Co-operatives and log books maintained onboard fishing vessels.

2.2.2 Data collection on fuel consumption

Two major harbours of Ernakulam district, Cochin and Munambam were selected for collecting data on fuel consumption of trawlers (Fig.2.2). Data on fuel consumption catch and other operational details of each trip were collected from 40 selected trawlers. Data were collected using structured and pre-tested questionnaires (Annexure III) for two continuous years, from June, 2014 to May, 2016. As rate of fuel consumption was observed to vary considerably between boats of various sizes, the stratified random sampling

techniques (Sukhatme & Sukhatme, 1970) was adopted for making the estimates. 10 trawlers from each category were identified and given the structured proforma to include fuel utilisation, area of operation, fishing time, duration of each trip and expenditure incurred for operation. The classes of mechanised trawlers are small trawlers (<12.0 m L_{OA}), medium trawlers (12.1 – 16.0 m L_{OA}), large trawlers (16.1 – 24.0 m L_{OA}) and very large trawlers (>24.1 m L_{OA}).

2.2.3 Economic survey

Relevant information about the investment, expense and revenue of trawlers was gathered through a combination of personal informal discussions and interviews with fishermen and trawl boat owners using pre-tested questionnaire. Structuring of the questionnaire allowed for both fixed alternative and open-ended questions for increased efficiency in data collection. The questionnaire was designed to obtain original information, which involved a direct field study of the trawlers. The study made use of both primary and secondary sources for data collection.

Data on capital investment and costs incurred for operations were collected through a pre-fixed schedule by visiting the field and interviewing fishermen. Questionnaire followed is given in Annexure IV. Total seven locations were identified and visited during the period November 2016 to June 2017. Data were collected from register maintained onboard trawler with the help of fishermen and boat owners.

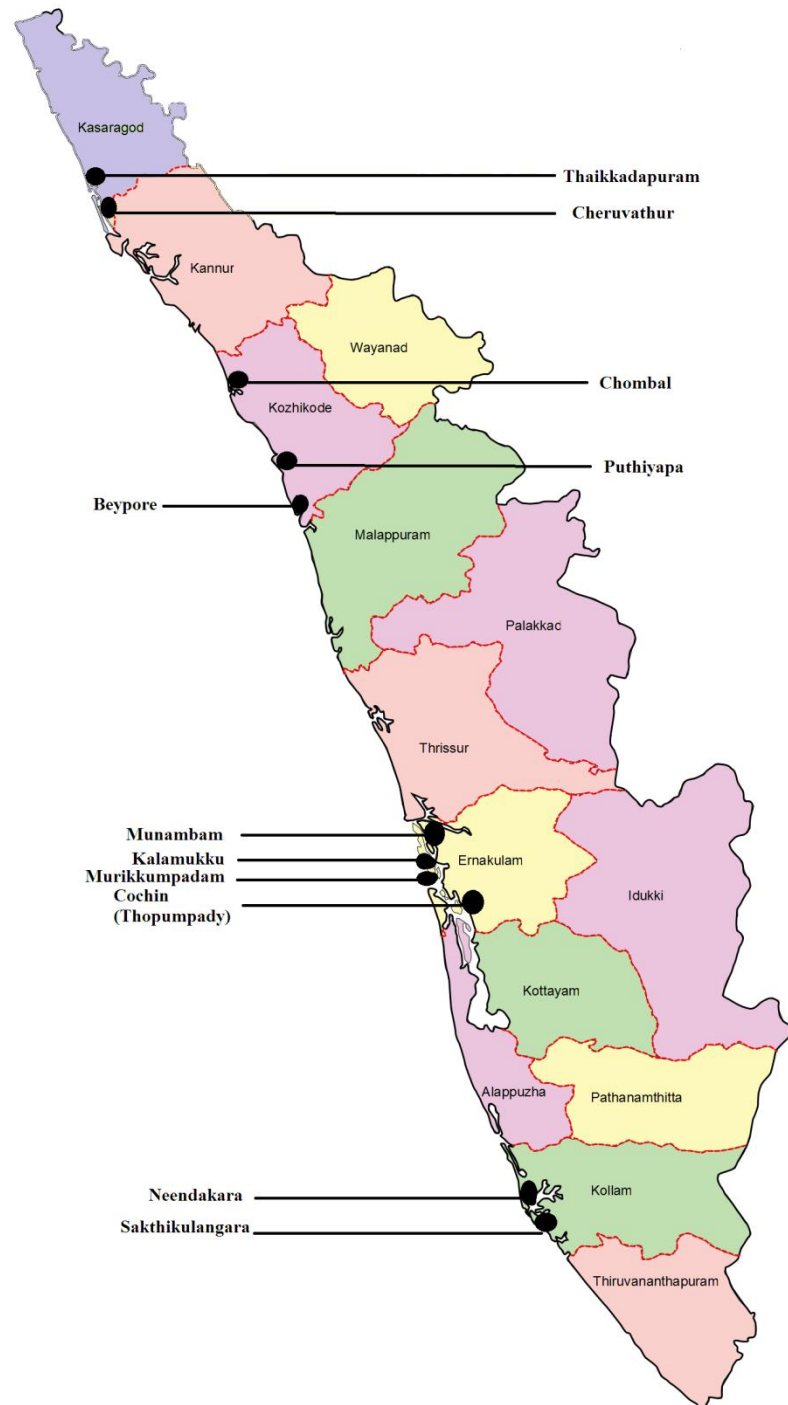

Fig.2.1 Map of Kerala showing coastal districts and fish landing centres selected for the study

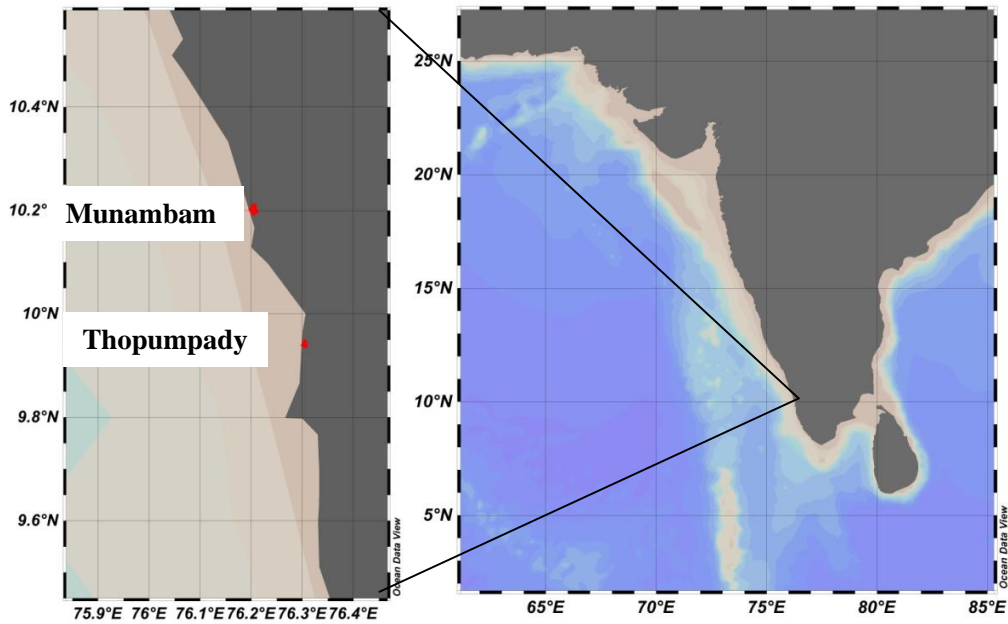

Fig.2.2 Study area, Cochin (Thopumpady) and Munambam

2.3 Experimental fishing

2.3.1 Experimental vessel

The experiment for evaluation of low drag trawl was conducted from ICAR-CIFT departmental vessel, R. V. Matsyakumari II (Fig.2.3). Technical specifications of the vessel is given in Table 2.1.

Table 2.1 Specifications of R. V. Matsyakumari II

LOA	17.70 m
Breadth (max)	6.0 m
Draft (max)	2.0 m
Tonnage (GRT)	66
Endurance	9 days
Engine power	325 hp @ 1800 rpm
Accommodation	Scientists -2, Crew -10



Fig.2.3 R. V. Matsyakumari II

2.3.2 Trawl nets

Two trawl nets of 24.0 m head rope length were used for the study, experimental net fabricated with ultra high molecular weight polyethylene (UHMWPE) webbing and second one as control using high density polyethylene (HDPE) webbing for evaluation of low drag trawl. The designs of UHMWPE and HDPE net are given in Fig.2.5 and Fig.2.6 respectively.

2.3.3 Experimental trials, data collection and analysis

Experimental fishing trials were conducted during February to April, 2017. Fishing trials were conducted in the Arabian sea, off Cochin area at 09°54' N76°05' E to 10°59' N76°10' E. Bathymetry ranged from 10 to 15 m which was kept almost constant for the accuracy of results. Trials were conducted for a period of 40 days, with four hauls of one hour duration each

day. Towing speed of the vessel varied from 2.33 to 4 kn. Length of warp released varied from 40 to 100 m according to the depth of the ground. Data regarding area, depth, towing speed, tow duration, warp length, fuel consumption, drag and total catch of each operation were recorded. Drag of each haul was measured using Warp Tension meter of 20 tonne capacity. Bal & Rao (1984) mentioned the use of tension meter to collect data on the tension exerted by warps and bridles. Fuel consumption is monitored manually with the help of engine crew and using fuel flow meter fitted onboard vessel. The questionnaire used for the study and schedule used to collect data from warp tension meter is given in Annexure V and VI respectively.

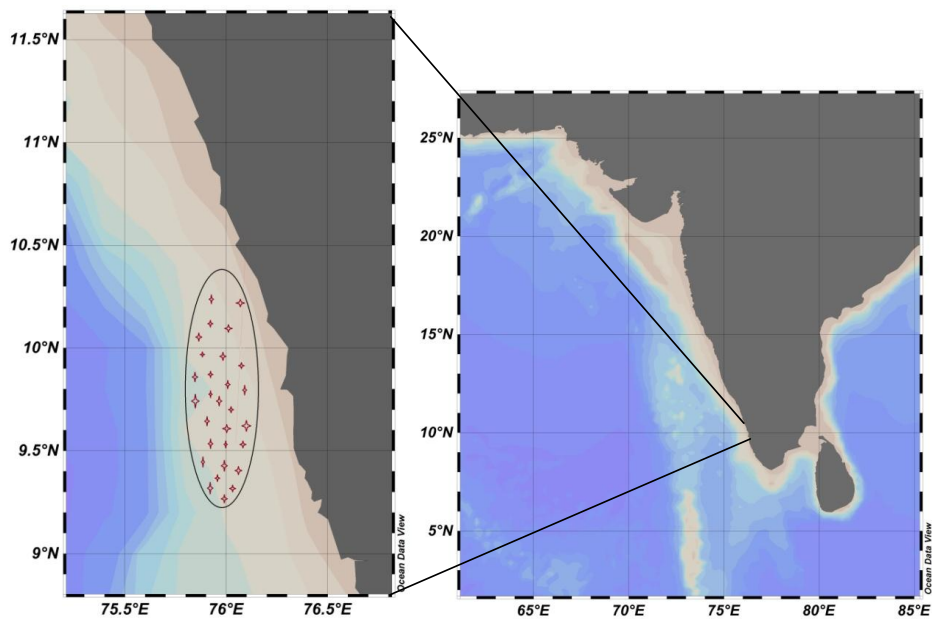

Fig.2.4 Areas covered during trawling experiment

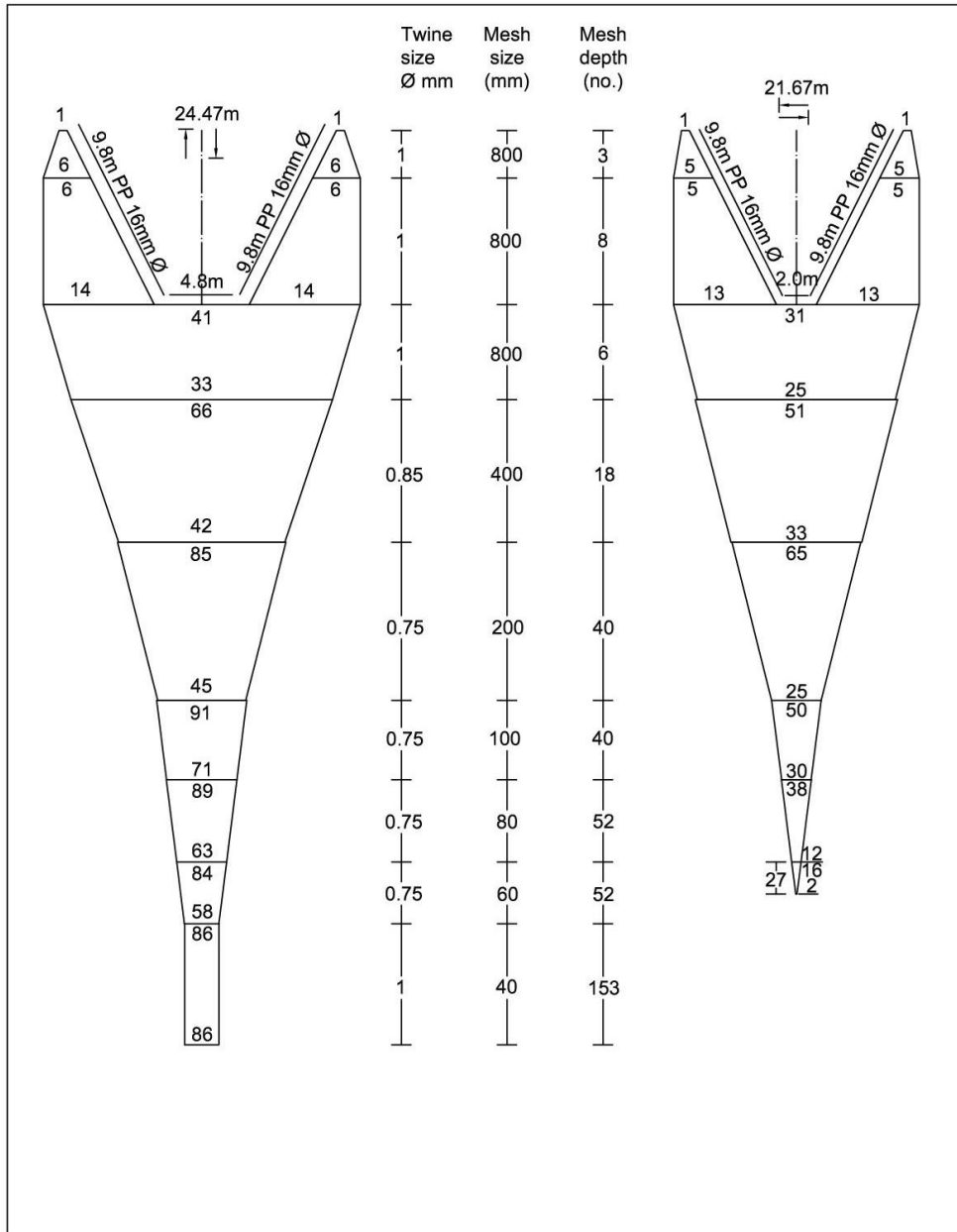

Fig.2.5 24.0 m UHMWPE trawl net

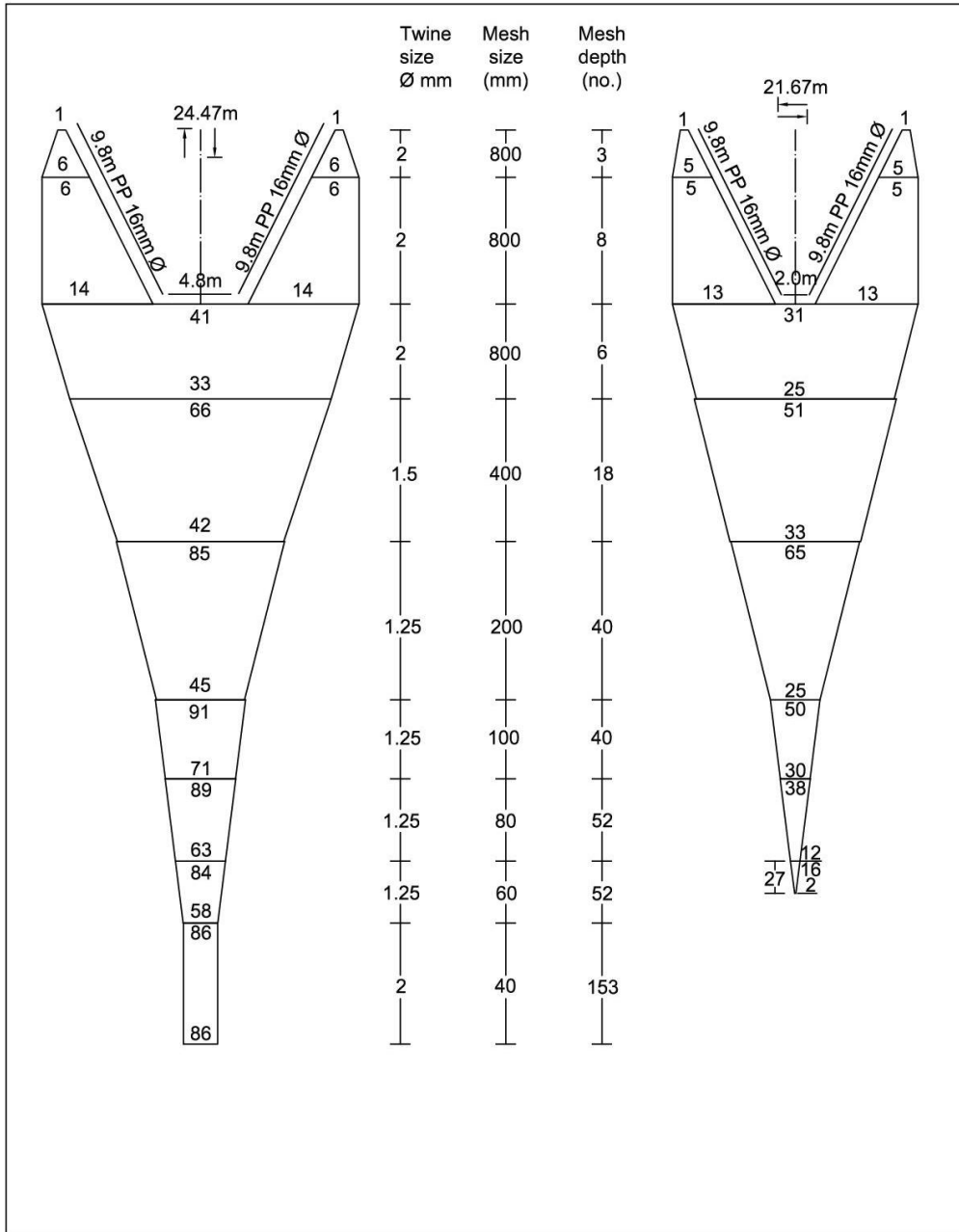

Fig.2.6 24.0 m HDPE trawl

ANNEXURE I**TRAWL FISHERY SURVEY PROFORMA**

District	Village	Craft	Gear	Engine	Date	Interviewer

General Information		
1.	Type of Fishing Vessel	Motorised/Mechanised
2.	Vessel name:	
3.	Owner's name	
4.	Address	
5.	Contact No.	
6.	Registration No.	
7.	Location	
8.	Craft's local name	
9.	Gear's local name	
Structural Details		
10.	L _{OA} (m)	
11.	Length at waterline (m)	
12.	Breadth/ Beam Max. (m)	
13.	Depth (m)	
14.	Freeboard (m)	
15.	Year built	
16.	Boat construction material	Wood / steel / fiberglass
17.	Make of engine	
18.	HP of engine@.....rpm
19.	Rpm Maximum	
20.	Model no:	

21.	Onboard Electronic equipments and Make	RT/VHF	GPS	Echo sounder	Chart
22.	Beacon				
23.	Propeller details	Size	Dia.	Pitch	
		No. of Blade		Wt. & Material	
24.	Propeller Nozzle Details				
25.	Reduction gear details	Reduction ratio		Make	
26.	Other details, if any:				

Gear Details

Structural Details			
53.	Length of head rope		
54.	Length of foot rope		
55.	Total Wt.		
56.	No. gear unit in a fleet of net onboard		
57.	Bycatch Reduction Device		
Material			
58.	Webbing material		
59.	Colour		
60.	Treatment, if any		
61.	Life of net (months/year)		
62.	How net is discarded after use?		
Ropes		Head rope	Foot rope
63.	Material		
64.	Rope size (dia. in mm)		
65.	Length (m)		
Floats		Type 1	Type 2
66.	Material		
67.	Shape		
68.	Size (dia in mm)		
69.	Total number used		
70.	Number of master float		
Sinkers			
71.	Material		
72.	Outer Dia (mm)		

73.	Inner Dia (mm)	
74.	Shape	
75.	Weight (g)	
76.	Total number used	
Otter Board		
77.	Material	
78.	Shape of Otter Board	
79.	Type of Otter Board	
80.	Wt. of Otter Board	
Operational details		
81.	Fishing area/port	
82.	Season (fishing)	
83.	Local crew or not	
84.	Cruising speed	
85.	Fishing speed	
86.	No. of Hauls	
87.	Fish school detection method	
88.	Time of fishing	
89.	Depth range of fishing operation	
90.	Duration of fishing trip	
91.	Number of operations per day	
92.	Number of fishing days	
93.	Fishing operation time	
94.	Target catch	
95.	Major bycatch	
96.	Use of bycatch	
97.	Total Crew onboard	
98.	Net hauling method	
99.	Fuel consumption per hour of operation	
100.	Specific fuel consumption	
101.	Is there any additives used with fuel	
102.	Total operational expense per day	
103.	Additional equipment for improving fuel efficiency	
104.	Landing area and catch disposal	

ANNEXURE II

TEMPLATE FOR TRAWL DESIGNS

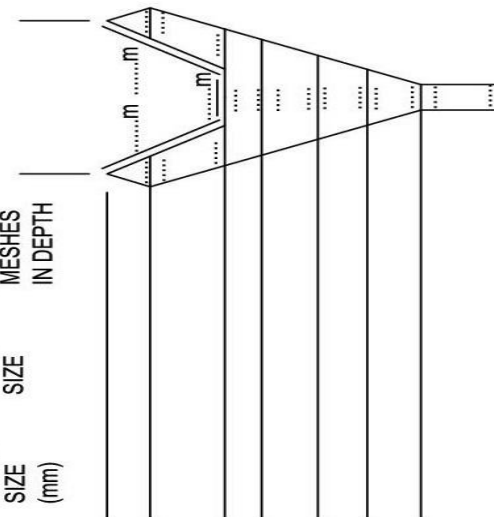
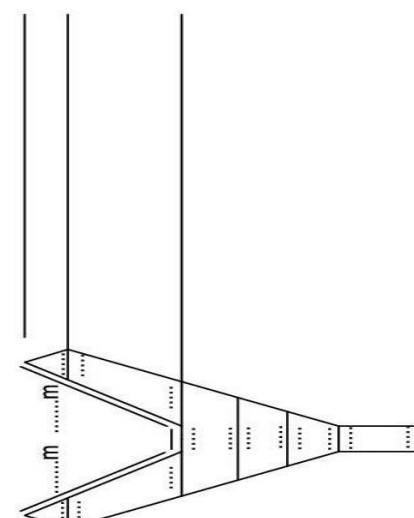
<p>Head rope length:.....m Rope dia:.....m Rope material:.....m</p>	<p>Foot rope length:.....m Rope dia:.....m Rope material:.....m</p>	<p>TWINE SIZE (mm)</p>	<p>NO. OF MESHES IN DEPTH</p>	<p>MESH SIZE</p>	<p>TWINE SIZE (mm)</p>	<p>NO. OF MESHES IN DEPTH</p>
						

ANNEXURE III**PROFORMA FOR FUEL CONSUMPTION, OPERATIONAL
DETAILS AND CATCH OF COMMERCIAL TRAWLERS**

Specification of trawler		
Name of fishing vessel:		
Registration No:		
LOA of craft		
Horse Power:		
No. and size of fishing gear:		
Account of diesel and Lubrication oil consumption		
Departure from port	Date:	Time:
Diesel at hand (litres):		
Lub oil at hand (litres):		
Arrival to port	Date	Time
Diesel at hand (litres):		
Lub oil at hand (litres):		
Operational expenses		
1	Cost of Fuel	
2	Wages – Fishing	
3	Wages – Non Fishing	
4	Batta and Food	
5	Ice and Baskets	
6	Landing charges	
7	Auction fees	
8	Repair and maintenance cost	
9	Other charges (specify)	
Catch details		
Total catch		
Major species	Name:	Weight:

ANNEXURE IV

**PROFORMA FOR INVESTMENT AND YEARLY
EXPENDITURE OF TRAWLERS**

A	Specifications of Boat	
1	Length of boat	
2	Material of construction	
3	Price of boat at the time of purchase	
4	Age of boat at the time of purchase	
5	Expected life of boat at the time of purchase	
6	Amount spend on modifications after purchase	
7	Average amount spend on modifications in one year	
8	Sources of finance for purchase	
9	Amount of loan	
10	Rate of Interest	
11	Duration of the loan	
12	Frequency of repayment of loan	
13	Instalment amount of loan	
14	Insurance amount	
15	Horsepower of engine	
16	Year of purchase of engine	
17	Cost of engine at the time of purchase	
B	Specification of Trawl Net	
18	Head rope length of trawl net	
19	Wing end mesh size of net	
20	Weight	
21	Price of trawl net (total)	
22	If fabrication is done,	
A	Cost for webbing	
B	Cost of otterboard	
C	Cost for floats	
D	Cost for sinkers	
E	Cost for ropes and warp	
F	Fabrication cost	
G	Other charges	

23	Amount spend on modifications in one year		
C	Variable Costs (Rs)	Year 1	Year 2
24	Amount of fuel use in one year		
25	Cost of Fuel		
26	Wages – Fishing		
27	Wages – Non Fishing		
28	Batta and Food		
29	Ice and Baskets		
30	Landing charges		
31	Auction fees		
32	Repair and maintenance cost		
33	Other charges (specify)		
D	Revenue (Rs)		

*ANNEXURE V***PROFORMA FOR EXPERIMENTAL TRIALS**

Specification of vessel	
Vessel:	Date: / / 2017
Net:	Starting Time: Ending Time:

Specification of operation				
	Haul 1	Haul 2	Haul 3	Haul 4
Time				
Lat-long				
Depth of operation				
Towing speed				
Total catch (kg)				
Warp Length (m)				
Account of fuel consumption				
Fuel consumption	Haul 1	Haul 2	Haul 3	Haul 4
Initial reading				
Final reading				

*ANNEXURE VI***PROFORMA FOR WARP TENSION DATA**

Haul 1				Haul 2			
Time	Towing speed (kn)	Tension (N)	RPM	Time	Towing speed (kn)	Tension (N)	RPM
00							
05							
10							
15							
20							
25							
30							
35							
40							
45							
50							
55							
60							

Haul 3				Haul 4			
Time	Towing speed (kn)	Tension (N)	RPM	Time	Towing speed (kn)	Tension (N)	RPM
00							
05							
10							
15							
20							
25							
30							
35							
40							
45							
50							
55							
60							



A PROFILE OF MECHANISED TRAWL FISHERY OF KERALA

3.1 Introduction

Kerala, situated at the south west part of peninsular India, has a slender stretch of land with a lush green mountain range on the eastern side and a long surf beaten coast on the western side extending 590 km. The territorial waters (22 km) and continental shelf area (13,000 sq. km) of the state is considered as the most productive area of Arabian Sea. The state is highly advanced and productive among the maritime states of India occupying fourth position in marine fish landing with a production of 5.23 lakh tonnes which is 14.41% of total marine fish landings of the country (CMFRI, 2017). Marine fishing fleet of the state depicts a growing status in the percentage share of mechanised vessels and this steady growth shows the significance of this endemic sector in marine fisheries of the state. Total number of fishing vessels in the state was 27254 in 1980 among which 3.6% were mechanised (CMFRI, 1981) and number of fishing fleet in 2010 is 21782 among which 21.68% is mechanised (CMFRI, 2012).

Trawls provide major portion of world's fish supply (Sainsburry, 1996). Trawling comprises towing, dragging and hauling of a conical shaped bag net with codend and wings to filter water. For capturing demersal populations, trawl is considered as an effective method in terms of yield and investment (Scofield, 1948). In Kerala, various crafts and gears and their combination are existing in marine fisheries sector. Mechanisation of Kerala

fisheries sector started in 1957 as part of the Indo-Norwegian project (INP) in which trawling started on commercial basis (Pillai *et al.*, 2004). They were introduced to exploit demersal resources beyond the traditional fishing grounds and earned great acceptance due to its high returns which paved way for its popularity along the entire coast. As it gradually became the most effective method for shrimp capture, it attracted more people which resulted in an exponential increase in number of trawlers. Since introduction, trawlers dominated the mechanised fishery both in terms of number of vessels and contribution to total landings of the state (CMFRI, 2012 & CMFRI, 2017). The number of trawlers in Kerala was 3678 contributing 77.89% of the mechanised fishing fleet (CMFRI, 2012). Kollam, Ernakulam and Kozhikode are the districts where 80% of the mechanised trawlers are distributed. Since trawlers are not resource specific, they are engaged in capture of majority of species landed along Kerala coast as main catch or bycatch. Even though trawlers are dominant in numbers and contribution to landing, it has a very strong negative part which includes bycatch and discard issues, destruction of benthic area of sea, high fuel consumption, etc (Kelleher, 2005; Boopendranath, 2002; Bhagirathan, 2009; Stiles *et al.*, 2010; Muir, 2015; Khaled & Priour, 2013; Park *et al.*, 2015).

There had been numerous studies on the trawl fishery of Kerala; including technical specifications and its changes, technical and economic efficiency by Satyanarayana & Nair (1964), Panicker & Sivan (1965), Kurian (1965), Kuthalingam (1965), Kuthalingam *et al.* (1978), Radhalakshmy & Nair (1985), Kartha & Sadanandan (1986), John (1996), Scariah *et al.* (1999), Boopendrantah (2000), Kurup & Rajasree (2007) Gibinkumar (2008), Sabu (2008), Aswathy *et al.* (2011), Edwin *et al.* (2014a) and Ravi (2015). However being a fast growing sector current status of trawl fishery of Kerala has to be

documented for better understanding for being an aid in management and policy decisions. Information to be updated are details of trawlers, engines, trawl nets, accessories and operation. In this chapter an attempt is made to bridge these gaps and updating the available data on the mechanised trawl fishery of Kerala.

3.2 Material and methods

An extensive survey of the entire coastline of Kerala was carried out for the study during November 2012 to October 2013 and information were updated during May-June, 2017. Data has been collected by visiting the field and interviewing the fishermen, boat owners, net menders and other stakeholders. A total of 18 harbours/landing centres were visited and the location of study area is given in Figure 2.1 (Chapter 2). According to CMFRI (2012), 80% of the trawlers of Kerala are distributed in Kollam, Ernakulam and Kozhikode district, hence major trawl landing centres and harbours of the districts along with Kasargode district are selected for the study. Neendakara and Shakthikulangara harbours of Kollam district; Munambam, Cochin, Kalamukkau and Murikkumpadam of Ernakulam district; Beypore, Puthiyapa and Chombal of Kozhikode district and Thaikkadapuram and Cheruvathur of Kasargod district were the centres selected. Well structured and pre-tested questionnaire and template were used for data collection (Annexure I and II, Chapter 2). Data representing each category of trawlers and trawl nets from every center were collected.

Documentation of trawl nets was done according to FAO standards following FAO conventions FAO (1975 &1978) and Nedlec (1982). Designs of typical and most common trawl nets along Kerala coast delineating design, material for fabrication, mesh size and twine size are prepared and documented.

3.3 Results and discussion

Results of the study to profile the mechanised trawling sector of Kerala are depicted. A fishing system involves vessel, gear and their operation. Based on the survey conducted, technical specifications of trawlers including length, engine power, crew size, duration of operation; trawl net including material of fabrication and dimensions and operation are described.

3.3.1 Trawlers

Trawlers, the vessel from which the trawl nets are operated are classified in various ways. According to the type of operation, there are stern trawler and side trawler and depending on the number of vessels operating single trawl net, there are one-boat trawlers and two-boat trawlers (pair trawlers). In Kerala, stern trawlers coming under the category of one-boat trawlers are prevalent. Scariah *et al.* (1999) also reported the dominance of stern trawlers in Kerala and disappearance of side trawlers in due course of time which were very few in number. Globally side trawling was the pioneer and during 1940s stern trawlers were introduced and became more popular. Reason behind acceptance and popularisation of stern trawling is, it has the advantages of maximum utilisation of towing power and ability to set the gear in a straight line (Hjul, 1972; Fyson, 1985).

3.3.1.1 Type of trawlers

Mechanised trawl fishery of Kerala is constituted by four category of trawlers (Edwin *et al.*, 2014a) namely small trawlers (less than 12.0 m L_{OA}), medium trawlers (12.0 – 16.0 m L_{OA}), large trawlers (16.0 – 24.0 m L_{OA}) and very large trawlers (>24.0 m L_{OA}). The size of trawlers in mechanised trawl sector of the state at present ranged from 10 to 33.5 m (32 - 110 feet). Edwin

et al. (2014a) specified the maximum length of trawlers in Kerala as 28.0 m which has grown to 33.5 m in due course of four years. Gibinkumar (2008) has reported the range of L_{OA} of trawlers in central Kerala as 9.8 to 21.6 m where there were no very large trawlers in operation. Sabu (2008) reported 18.2 m as maximum L_{OA} of trawlers from Quilon coast. The percentage contribution of each size class of trawlers in different areas ranged from 12 to 26% small trawlers, 8 to 17% medium trawlers, 60 to 72% large trawlers and 2 to 8 % very large trawlers. On an average there were 20% small trawlers, 10% medium trawlers, 67% large trawlers and 3% very large trawlers in the mechanised trawl fishery of the state among which large trawlers are identified as the largest contributor. Percentage contribution of small and medium trawlers showed a declining trend, because the construction of these trawlers rare. Large and very large trawlers can be said to be more dynamic in terms of number of newly constructed vessels as fishermen prefer to construct these for maximum endurance and increased storage space. Decreasing trend in number of mechanised vessels below 40 feet in Kerala coast has been reported by Unnithan *et al.* (2005) because of its poor economic performance. The study also observed fishermen's preference to larger vessels with high powered engines in mechanised sector for maximum endurance during the period.

ICAR-Central Institute of Fisheries Technology (ICAR-CIFT) has a major role in trawl fishery of Kerala since its introduction. Indo- Norwegian Project (INP) and ICAR-CIFT has introduced and popularized wide range of trawlers with a length overall ranging from 7.62 m to 17.52 m and in the dawn of mechanization upgradation of small country crafts were the method adopted (Verghese, 1998). CIFT has introduced various designs of bottom trawls such as various two - seam and four - seam trawls, long wing trawl, bulged belly and six

- seam trawl and energy saving concepts in trawl design such as rope trawl, large mesh trawl and semi-pelagic trawl (CIFT, 2003 & Pravin *et al.*, 2013).

3.3.1.2 Material of construction

Steel and wood are the materials used for construction of trawlers in Kerala, but a gradual shift in boat construction material to steel rather than wood is observed. Gibinkumar (2008) and Sabu (2008) have also observed the preference of steel trawlers rather than wooden trawlers in Central Kerala and Quilon coast respectively. Scarcity of quality timber at reasonable price, issues related to labour and maintenance of wooden vessels and ease of availability of optimum grade steel, etc promote the acceptance of steel as boat building material among boat owners. Presently, approximately 5% of trawlers are wooden constructed which are coming under the category of small trawlers. Ravi (2015) reported that 20% trawlers in Kerala during 2012-13 are wooden and also stated a declining trend in number of wooden trawlers.

3.3.1.3 Engine details

In proportion to the increase in size of trawlers, engine power is also increasing and has reached above 550 hp in Kerala at present. Exclusive use of Chinese engines is noted in large and very large trawlers. Small trawlers use either Indian made or imported engines with power range of 116-350 hp. Imported engine brand, Ruston is exclusively used by small trawlers conducting single day operations and the same has been reported by Gibinkumar (2008). Majority of medium trawlers use imported engines and less than 10% use Indian made engines. However engine power of these trawlers ranged from 240– 427 hp irrespective of the make of engine. Large and very large trawlers exclusively use imported engines of 350 – 495 hp and 427 – 550 hp respectively (Table 3.1). Kurup & Rajasree (2007) had observed

engine of 680 hp in Kerala coast but according to fishermen it has been vanished very soon because of higher fuel consumption and resultant increment in cost of fishing. Imported engines used in trawl sector in the state are; Weichai, Yuchai, Sinotruk and Cummins and the only Indian made engine is Ashok Leyland marine diesel engines. Ravi (2015) stated that engine power of small trawlers started from 76 hp which extended up to 450 hp in very large trawlers, but at present in 2017 no mechanised trawlers are using engine below 116 hp except in motorized trawling sector.

3.3.1.4 Crew size

Number of crew in small trawlers ranged from 4-5 in single day operations and 4-8 in multiday operations. Medium trawlers accommodate 10-12 crew and rarely up to 15 depending on the season and in large and very large trawlers the number of crew mostly ranged from 10 –20 depending on seasons. Aswathy *et al.* (2011) reported a maximum of 10 crew in large vessels with L_{OA} more than 16.0 m trawlers during 2007. Gibinkumar (2008) reported number of crew in small trawlers as 5 and in medium and large trawlers as 6-8 in Quilon coast and Ravi (2015) reported 4 crew in small trawlers and 12 in very large trawlers.

3.3.1.5 Duration of fishing

Both single day and multiday fishing is carried out by trawlers in Kerala. However majority are engaged in multiday fishing operations. Panikkar *et al.* (1991) highlighted the shift towards the multiday trawler units in the state due to better catch and returns. Duration of fishing varied from 3 to 4 days in small trawlers, 6 – 10 days in medium trawlers and 10 – 15 days in both large and very large trawlers. Earlier, fishing up to 21 days has been reported (Edwin *et al.*, 2014a) but to reduce the fuel consumption and to improve the profitability of

fishing, fishermen themselves reduced the days spent at sea. Similar trend has also been reported by Cheilari *et al.* (2013) among EU fishing fleet. A maximum of 10 days of duration of fishing by trawlers of Central Kerala and Quilon coast has been detailed by Gibinkumar (2008) and Sabu (2008).

3.3.1.6 Net used

Trawlers in Kerala are equipped to carry 6 – 12 trawl nets depending on the size of vessel and net. Ravi (2015) also has reported the use of six number of trawl nets by small trawlers. Trawl net used by small trawlers is comparatively small, head rope length ranged from 20 – 30 m mainly targeting shrimps. Size of net used by medium trawlers ranged from 25-100 m and large and very large trawlers used nets with 30 – 125 m head rope length. Shrimp trawls are preferred by small trawlers and others use fish trawls, shrimp trawls and cephalopod trawls according to the availability of fish and season.

3.3.1.7 Trawling season

Trawlers in Kerala operate throughout the year except during trawl ban period. Govt. of Kerala has imposed a seasonal ban for mechanised trawlers since 1988 through which operation of the trawlers are banned for a period of 21 – 70 days in various years (Nair, 1989). At present it is for 47 days from June 15th to July, 31st. Single day trawlers conduct fishing exclusively during November to May, peak fishing season and crew will be engaged by larger trawlers during off season.

3.3.1.8 Electronic equipment

All the vessels in mechanised category is equipped with electronic navigational and fish finding equipment viz., Global positioning system (GPS), echosounder and VHF. Echosounder is used for locating fish and to

know the depth and nature of bottom of fishing ground. GPS is used for direction and locating fishing ground and VHF and cellular phones are in use for communication.

3.3.1.9 Fish hold

The size of trawlers is in an increasing trend mainly aiming at increased storage capacity. The fish hold capacity of very large trawlers has grown more or less 75 m³ at present in Kerala.

Table 3.1 Technical specifications of mechanised trawlers of Kerala

Specifications	Small trawler	Medium trawler	Large trawler	Very large trawler
L _{OA} (m)	< 12.0	12.0 – 16.0	16.0 – 24.0	> 24.0
Material of construction	Wood and steel	Steel	Steel	Steel
Percentage contribution	20%	10%	67%	3%
Engine power (hp)	116 – 350	240 – 427	350 – 495	427 - 550
Make of engine	Ruston, Ashok Leyland	Ashok Leyland, Weichai, Yuchai, Sinotruk, Cummins	Weichai, Yuchai, Sinotruk, Cummins	Weichai, Yuchai, Sinotruk, Cummins
Size of net used (m)	20 – 30	25 – 100	30 – 125	30 – 125
No. of crew	4 – 5	10 – 12	10 -18	10 - 18
Duration of trip	3 – 4	6 – 10	10 – 15	10 - 15

3.3.2 Trawl nets

Initially trawl nets operated in Kerala coast were bottom trawls targeting shrimps, but the scenario has been changed and both bottom and off-bottom trawls are in operation at present. Trawl nets are operated along entire

Kerala coast to catch finfish, crustaceans and molluscs at present. Popular resource specific trawl nets used in the mechanised trawl sector of Kerala are *thalayan vala* (ribbonfish trawl), *kilimeen vala* (threadfin trawl), *avoli vala* (pomfret trawl), *ayala vala* (mackerel trawl), *chooda vala* (anchovy trawl), *meen vala* (fish trawl), *manthal vala* (flatfish trawl), *meen vala* (fish trawl targeting group of finfishes), *poovalan vala* (targeting *Metapenaeus dobsoni*), *karikkadi vala* (targeting *Parapaenopsis stylifera*) *naran vala* (targeting *Fenneropenaeus indicus*), *pullan vala* (targeting deep sea shrimps), *kanava vala* (targeting *Sepia pharonis*), *koonthal vala* (targeting Squids), *octopus vala* (targeting octopus) and *chanku vala* (whelk trawl). Adoption of eco-friendly designs like semi-pelagic trawl system (CIFT, 2011) for selective harvesting of fish needs to be popularised along Kerala coast for minimizing the impacts of trawling on ecosystem and resources.

3.3.2.1 Type of trawl nets

Trawl nets are classified based on various aspects like depth of operation, species targeted, means of mouth opening, number of trawl nets operated from single vessel, number of panels, etc. A detailed classification of trawl nets operated along Kerala coast is depicted in Fig.3.1.

Based on mouth opening

Trawl nets operating along Kerala coast are otter trawls as the mouth opening is achieved by a pair of otter boards. Beam trawls had been in use during initial phases of trawling introduction in Kerala and was popular until 1990s (Scariah *et al.*, 1999) but now has been totally replaced by otter trawls.

Based on target species

Depending on the target group, trawl nets are categorised to fish trawl, shrimp trawl, cephalopod trawl and gastropod trawl. Fish trawls are those which targeting finfish either off-bottom or bottom dwelling. Even though trawls are not target specific, trawls are operated for catching ribbonfish, anchovies, mackerel, sole fish, etc. are popular in state Fish trawls have prime importance in number, contribution to landing and the size or length of head rope. Ribbonfish, pomfrets, croakers, threadfins, horse mackerel, polynemids, catfish, barracudas, lizardfish, carangids, mackerel, anchovies, false trevally and flatfish are the major finfish targeted by fish trawls (CMFRI, 2017). Second category of trawl nets prevalent along Kerala coast are shrimp trawls. Every trawler posses two to three shrimp trawls and will be operating according to the availability of shrimps. Operation of shrimp trawls are demersal and depth of operation ranged from 4 to 800 m (Edwin *et al.*, 2014a). *M. dobsoni*, *P. stylifera*, *M. monoceros*, *F. indicus* and *Solenocera choprai* are the major shrimp catch from Kerala coast. Third category among trawl nets of the state are Cephalopod trawls targeting squid, cuttlefish and octopus. They are operated seasonally from main fishing harbours of Kerala. 70-80% of the cephalopod landings in Kerala is coming through trawlers (Nair *et al.*, 2015). *Euroteuthis duvauceli*, *Sepiella inermis*, *Sepia pharaonis*, *S. eliptica*, *Amphioctopus membranaceous* and *Octopus dofusii* are the major cephalopod species landed in cephalopod trawls. Gastropod trawl is the fourth category of trawls operated in Kerala coast. Design and technical specification of these trawls are similar to that of shrimp trawls. Gastropod trawls are seen in Kollam coast operated mostly by small trawlers which are conducting single

day operations. Venkatesan *et al.* (2015) reported the dominance of single day trawlers in landing bivalves and gastropods along Kerala coast. *Babylonia spirata* and *B. zeylanica* are the major gastropod species landed in the trawls of Kerala.

Technical specifications of different category of trawl nets are furnished in Table 3.2.

Based on depth of operation

According to the depth of operation off-bottom and bottom trawls are prevalent in Kerala. Shrimp trawls, cephalopod trawls and gastropod trawls are exclusively demersal trawls, but in fish trawls, both bottom and off-bottom types were found.

Based on the number of panels

According to the number of panels used for fabrication, there are both two seam trawls and four seam trawls among which two seam is most widely used. Mostly shrimp trawls are two seam in construction and four seam trawls are coming under the category of fish trawls. Popularisation of four seam trawls along west coast and two seam trawls along east coast of India has been predicted by Satyanarayana *et al.* (1972).

Categorization of trawl nets operated along Kerala coast is given in Fig.3.1.

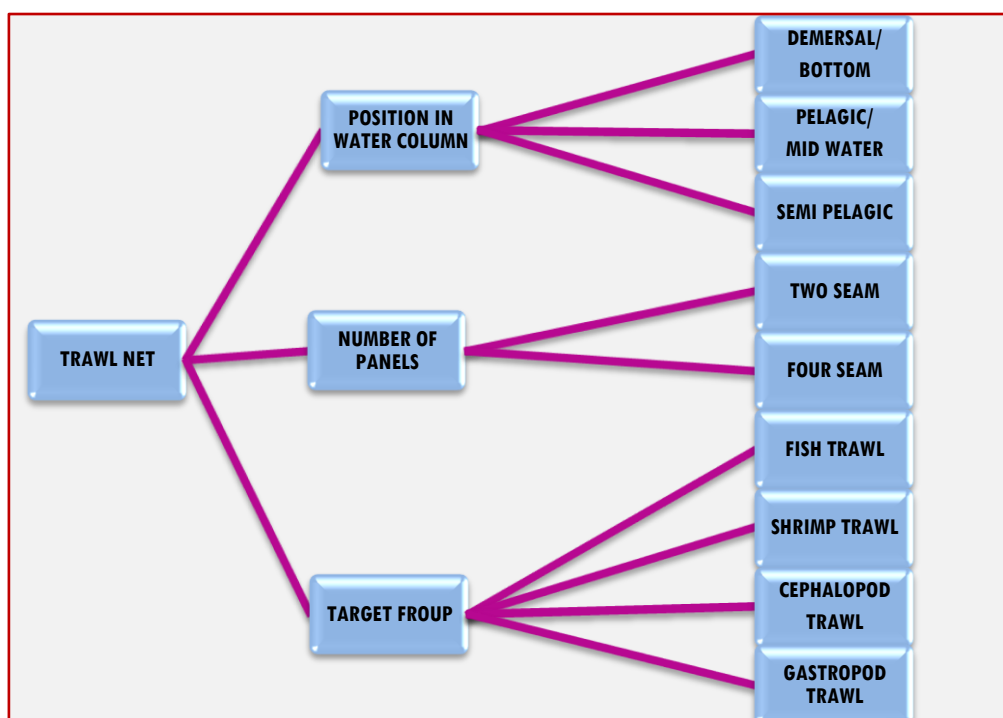

Fig.3.1 Classification of trawl nets of Kerala

3.3.2.2 Design of trawl nets

Trawl net should be designed in the manner that it offers minimum resistance as the quantity of catch in trawl net depends on the amount of water filtered during operation (Deshpande, 1960). Design details of a trawl gear include material of fabrication, mesh size and twine size of webbing, number of meshes in the upper and lower edges and height of each section, details of ropes used, etc. Design features of trawl nets are determined according to the species targeted and local preferences which is reported by Nair (1969).

Design of trawl nets operated along Kerala coast has been surveyed from a very wide perspective. Material used for trawl net fabrication is exclusively high density polyethylene (HDPE). Earlier cotton, manila and sisal were the materials used for fabrication of trawl webbing and ropes. Attempts

were made to fabricate the trawl nets with nylon nets, but the prohibitive cost and chances of losing the gear limited its use (Mukundan & Hameed, 1993). Hence HDPE is the most suitable material for fabrication of trawl nets in terms of life of net and cost. Large mesh trawls are very popular in Kerala in order to reduce the fuel consumption. Mesh size of trawl nets operated along Kerala coast ranged from 32 to 10000 mm regardless the type of trawl net and twine size of the webbing used varied from 0.25 to 4.0 mm at present. A profile of trawl nets operated along Kerala coast is given in Table 3.3.

Fish trawls

Head rope length of fish trawls varied from 39.6 to 145.0 m and polypropylene ropes with 10 - 16 mm diameter were used for head rope and foot rope. HDPE multi filament twisted twines of 0.25 to 4.0 mm diameter were used for the netting. Large mesh fish trawls with a wing end mesh size up to 10000 mm are now popular in the sector whereas codend mesh size was in the range of 20 - 25 mm. Common fish trawls operated along Kerala coast are *thalayan vala* (ribbonfish trawl, fig.3.2), *kilimeen vala* (threadfin trawl, fig.3.3), *avoli vala* (pomfret trawl, fig.3.4), *ayala vala* (mackerel trawl, fig.3.5), *chooda vala* (anchovy trawl, fig.3.6), *meen vala* (fish trawl, fig.3.7) and *manthal vala* (flatfish trawl, fig.3.8).

Shrimp trawls

Shrimp trawls are smaller in size compared to fish trawls and cephalopod trawls in the state and the head rope length ranged from 34.2 to 58.0 m. Polypropylene rope with 10 - 16 mm diameter is used as head and foot rope. HDPE twines of 0.5 - 2.0 mm diameter is used for fabrication of the net in all regions of the state. Mesh size of the shrimp trawl at wing end varied from 32 - 300 mm and 20 - 25 mm at the codend. Mostly shrimp trawls are

without an overhang section. Nair (1969) has reported the absence of overhang section in shrimp trawls along Kerala coast. Most common shrimp trawls along Kerala coast are *poovalan vala* (fig.3.9), *karikkadi vala* (fig.3.10), *naran vala* (Fig.3.11) and *pullan vala* (Fig.3.12).

Cephalopod trawls

Head rope length of cephalopod trawls ranged from 50.0 to 65.0 m and are fabricated of HDPE webbing of diameter 0.5 to 3.0 mm. Mesh size of 1000-1200 mm in the wing region scales down to 20 to 25 mm in the codend. PP rope of diameter 12 to 14 mm were used for the head rope and foot rope. Trawl nets coming under this category are *kanava vala* targeting cuttlefish (Fig.3.13), *koonthal vala* targeting squid (Fig.3.14) and *octopus vala* targeting octopus (Fig.3.15).

Gastropod trawls

Head rope length of gastropod trawl ranged from 20-25 m and are made of HDPE webbing of 0.5 to 2.5 mm. Mesh size at the wing end varied from 40-80 mm and the codend mesh size is 20-25 mm. Whelk trawls are the most common trawl nets coming under this category which is locally known as *chanku vala* (Fig. 3.16). Major species targeted by whelk trawls are *Babylonia spirata* and *B. zeylanica*.

Designs of trawl nets operated along Kerala coast are in accordance with the findings of Sabu (2008), Gibinkumar (2008), Edwin *et al.* (2014a), Ravi (2015) and Sayana *et al.* (2015).

Table 3.2 Technical specifications of different types trawl nets in Kerala coast

Specification	Fish trawl	Shrimp trawl	Cephalopod trawl	Gastropod trawl
Head rope length (m)	39.6 – 145.0	34.2 – 58.0	50 – 65	20-25
Webbing material	High Density Polyethylene (HDPE)			
Twine size (mm)	0.25 – 4.0	0.5 – 2.0	0.5 – 3.0	0.5-2.5
Wing end mesh size (mm)	80 – 10000	40 – 300	1000 – 1200	40-80
Codend mesh size (mm)	20 – 25	20	20 - 25	20-25
Rope material	Poly Propylene (PP)			
Rope diameter (mm)	10 – 16			12

Table.3.3 Profile of trawl nets used by mechanised trawlers in Kerala coast

Vernacular name	Trawl net	Target species	HR length (m)	Wing end mesh size (mm)	Codend mesh size (mm)
<i>Thalayan vala</i>	Ribbonfish trawl	<i>Trichiuridae spp.</i>	145	10000	25
<i>Ayala vala</i>	Mackerel trawl	<i>Rastrelliger kanagurta</i>	81	1000	20
<i>Chooda vala</i>	Anchovy trawl	<i>Stolephorus spp.</i>	64	1500	20
<i>Avoli vala</i>	Pomfret trawl	<i>Pampus argenteus</i>	76.5	1500	20
<i>Kilimeen vala</i>	Threadfin trawl	<i>Nemipterus japonicas</i>	40	200	20
<i>Meen vala</i>	Fish trawl	Finfish	58	80	20
<i>Manthal vala</i>	Flat fish trawl	<i>Cyanoglossus spp.</i>	39.6	200	20
<i>Karikkadi vala</i>	Shrimp trawl	<i>Parapenaeopsis stylifera</i>	34.2	40	20
<i>Poovalan vala</i>	Shrimp trawl	<i>Metapenaeus dobsoni</i>	51	300	20
<i>Naran vala</i>	Shrimp trawl	<i>Feneropenaeus indicus</i>	58	80	20
<i>Pullan vala</i>	Deep sea shrimp trawl	<i>Metapenaeopsis andamanensis</i> , <i>Aristeus alcocki</i> , <i>Solenocera choprai</i> , <i>Heterocarpus gibbosus</i> , <i>H. woodmasoni</i> <i>Plesionika quasigrandis</i> ,	40	40	20
<i>Kanava vala</i>	Cuttlefish trawl	<i>Sepia pharonis</i> , <i>Sepiella inermis</i> , <i>S. eliptica</i>	54	1000	20
<i>Koonthal vala</i>	Squid trawl	<i>Euroteuthis duvaucelli</i> ,	57.8	1200	20
<i>Octopus vala</i>	Octopus trawl	<i>Amphioctopus negelectus</i> , <i>A. marginatus</i> , <i>Cistopus indicus</i> , <i>Octopus lobensis</i>	65	1000	20
<i>Chanku vala</i>	Whelk trawl	<i>Babylonia spirata</i> <i>B. zeylanica</i>	22	80	20

3.3.3 Trawl accessories

Trawl accessories are the equipment or tools used in operation of trawl nets for facilitating optimum mouth opening vertically and horizontally. A wide variety of accessories are in use for trawl net, among which a pair of otterboards, floats and sinkers, bridles and warp, etc. are important.

3.3.3.1 Otter boards

Otterboards are the sheer devices used for providing horizontal spread of trawl mouth. Two types of otter boards are used in Kerala viz., wooden flat rectangular and 'V' form steel otter boards. Trawlers below 10 m L_{OA} use flat rectangular otter boards made of wooden planks reinforced with steel frames. Almost all vessels have one or two sets of otter boards and are interchanged depending on requirement. Weight of otter board ranged from 25 to 150 kg each, which is determined by the size of the trawl net and installed engine power. 'V' form otterboards are more popular in mechanised trawl fishery of Kerala except for small trawlers. Exclusive use of flat rectangular otterboards by the trawlers of Kerala coast and Cochin has been reported by John (1996) and Mukundan & Hameed (1993).

3.3.3.2 Floats and sinkers

Floats are used in head rope of trawl nets to facilitate vertical spread of trawl mouth. Similarly sinkers are used to keep the position of foot rope; on or near the bottom in bottom trawls and at required depth in off-bottom trawls. Two types/sizes of floats are used in trawl nets, large sized and small sized floats and total number of floats varied from 5 to 17. Size of large floats varied from 20 to 35 cm and that of smaller ones are 7.5 to 10 cm and they are made of HDPE or Acrylonitrile Butadiene Styrene (ABS). Spindle shaped or cylindrical sinkers or iron chains are used as sinkers and both are used either separately or in combination. Sinkers are made of either lead or iron each

weighing 30 to 250 g. Total weight of sinkers used varied from 30 to 80 kg depending on the size of the trawl net as reported by Ravi (2015) and Edwin *et al.* (2014a).

3.3.3.3 Bridles

Bridles are the connecting wires, linking the otter boards and the legs of the net in order to widen the swept area of the trawl. Polypropylene ropes of 22 mm diameter and 20 to 40 m in length are generally used as bridles.

3.3.3.4 Warp

Lubricated steel wire ropes of diameter ranging from 8 to 18 mm with marking at intervals are used as trawl warps. Plastic coated wire ropes are recently introduced in Kerala to avoid grease and make the deck clean. Warps are connected to the otterboards by means of G-link assembly. Length of trawl warp depends upon the depth of operation and usually a length of about five to eight times the depth of operation is released. The total length of the wire rope in the drum varied from 500 to 1500 m.

3.3.4 Trawling operation

In Kerala both single-day and multi-day trawlers are prevalent, but single-day trawlers constitute only 5% of the total trawl fleet and the remaining 95% are multi-day trawlers. Trawlers coming under the category of small trawlers ($L_{OA} < 12.0$ m) are the only group conducting single-day operations. Single-day trawlers will operate only during peak seasons i.e., seven months from November to May. Multi-day trawlers conduct fishing throughout the year from August to middle of June, except trawl ban period. Depth of operation of trawlers in the state varied from 10 m to beyond 800 m. Single-day trawlers start operation by morning 5'O clock and will be coming back before evening. Multi-day trawlers mostly start their operation during evening hours and will be reaching the fishing ground by night and will be

coming back during morning hours. Before operations, the net is rigged and kept ready and after reaching fishing ground the net is released. Initially codend is thrown to sea followed by net then otterboards and finally warp is released. Before the net is released, speed of the vessel is reduced and set according to the target. The tow duration extend up to 2 to 3 hours and sometimes 1.5 hours depending on the catch. After 1-3 hour of towing, warp is hauled first, then otterboards and keeps them in their position and net is hauled and pulled onto the deck manually or with the help of ropes and pulleys. Most of the trawl nets possess a cover for the codend, which is untied first followed by codend and catch is released onboard. Then catch is transferred to fish hold and net is ready for next operation. Trawlers carry 2 to 3 shrimp trawls, 1 to 2 cephalopod trawls and 7 to 8 fish trawls and will be operating depending on the availability of fishes and season. For multiday trawlers exist three seasons based on target;

Shrimp season - starts in August and extends up to October, post monsoon period. The main target during this time is shrimps and towing speed ranged from 2.5 to 4 kn.

Shrimp/finfish/Cephalopod Season (*season without any specific target*) - starts in November and ends in March. During this season, specific target fishery is not there and the nets are operated depending on the availability of fish. A common practice is shrimp trawls are operated during daytime and finfish and cephalopod trawls operate during morning and evening hours. Towing speed in this season is 2.5 to 6 kn.

Finfish Season - is the season with shortest time span, which starts in April till middle of June, prior to trawl ban period. Main target during this time is finfish and towing speed usually ranged from 4 to 6 kn.

3.4 Conclusion

Trawling is one of the common and predominant fishing system along Kerala coast. Trawlers contribute 78% of the mechanised fishing fleet of the state. Four categories of trawlers viz., small, medium, large and very large trawlers are operated in which only few small trawlers conduct single day operations and remaining exclusively conduct multiday operations extending up to 15 days. Percentage of small and medium trawlers is in a declining trend, large trawlers possess a consistent status and very large trawlers grow very fast in number. At present there are 20% small trawlers, 10% medium trawlers, 67% large trawlers and 3% very large trawlers among the mechanised trawlers of Kerala. They conduct fishing whole year except trawl ban period. Due to the unavailability of boat constructing timbers and other technical reasons like life and endurance of vessel the existence of wooden trawlers gradually decreased and constitute only 5%, hence the sector is dominated by steel trawlers at present. Target groups include fish, shrimps, cephalopod and gastropod resources.

Fish trawls, shrimp trawls, cephalopod trawls and gastropod trawls are the type of trawl nets operated in Kerala. Shrimp trawls and cephalopod trawls are exclusively demersal type and fish trawls are bottom or off-bottom type. Majority of the designs were two seam type and the deployment of a particular net is based on the availability of the resource in fishing ground. Analysis revealed an upward trend in the size of the net used and the most common material used for fabrication was High Density Polyethylene (HDPE). Mesh size used varied from 20 to 10000 mm in fish trawls, 20 to 300 mm in shrimp trawls, 20 to 1200 mm in cephalopod trawls and 20 mm to 80 mm in gastropod trawls. Irrespective of the type of trawl, codend mesh size ranged 20-25 mm which is less than prescribed in KMFRA. V' form otterboards are most wide spread in Kerala, except for small trawlers.

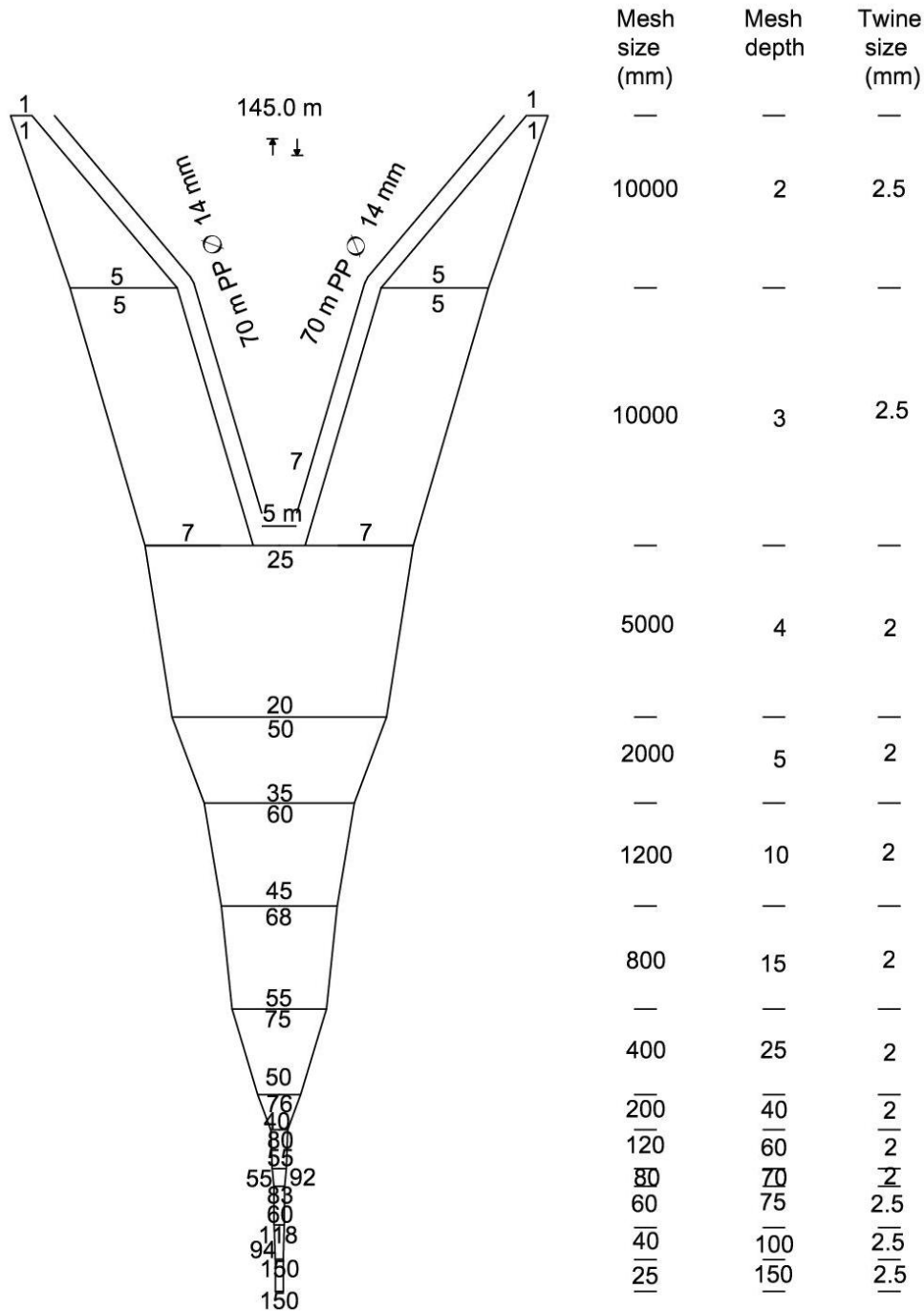

Fig.3.2 145 m Ribbon fish trawl (*Thalayan vala*)

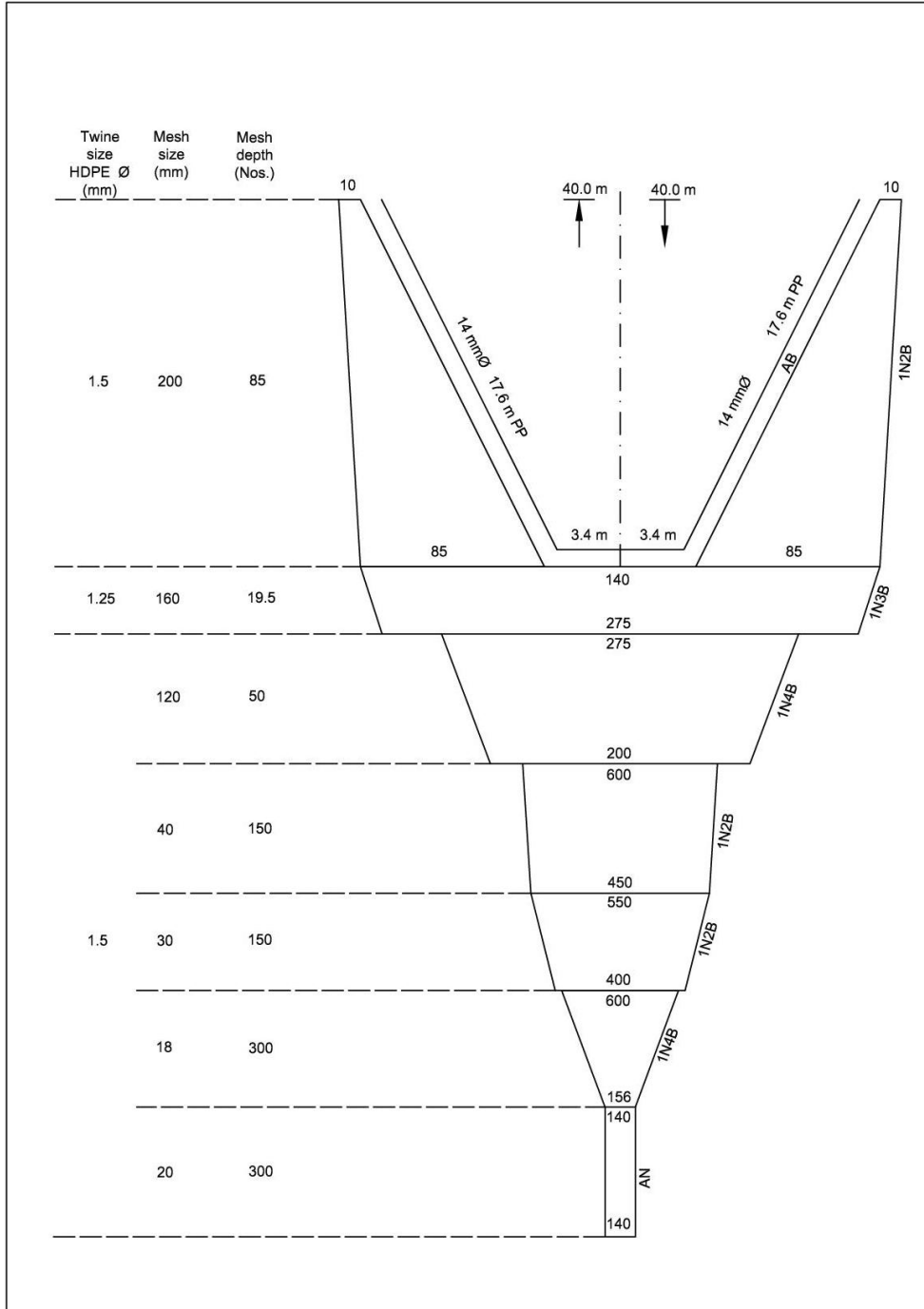

Fig.3.3 40.0 m Threadfin trawl (*Kilimeen vala*)

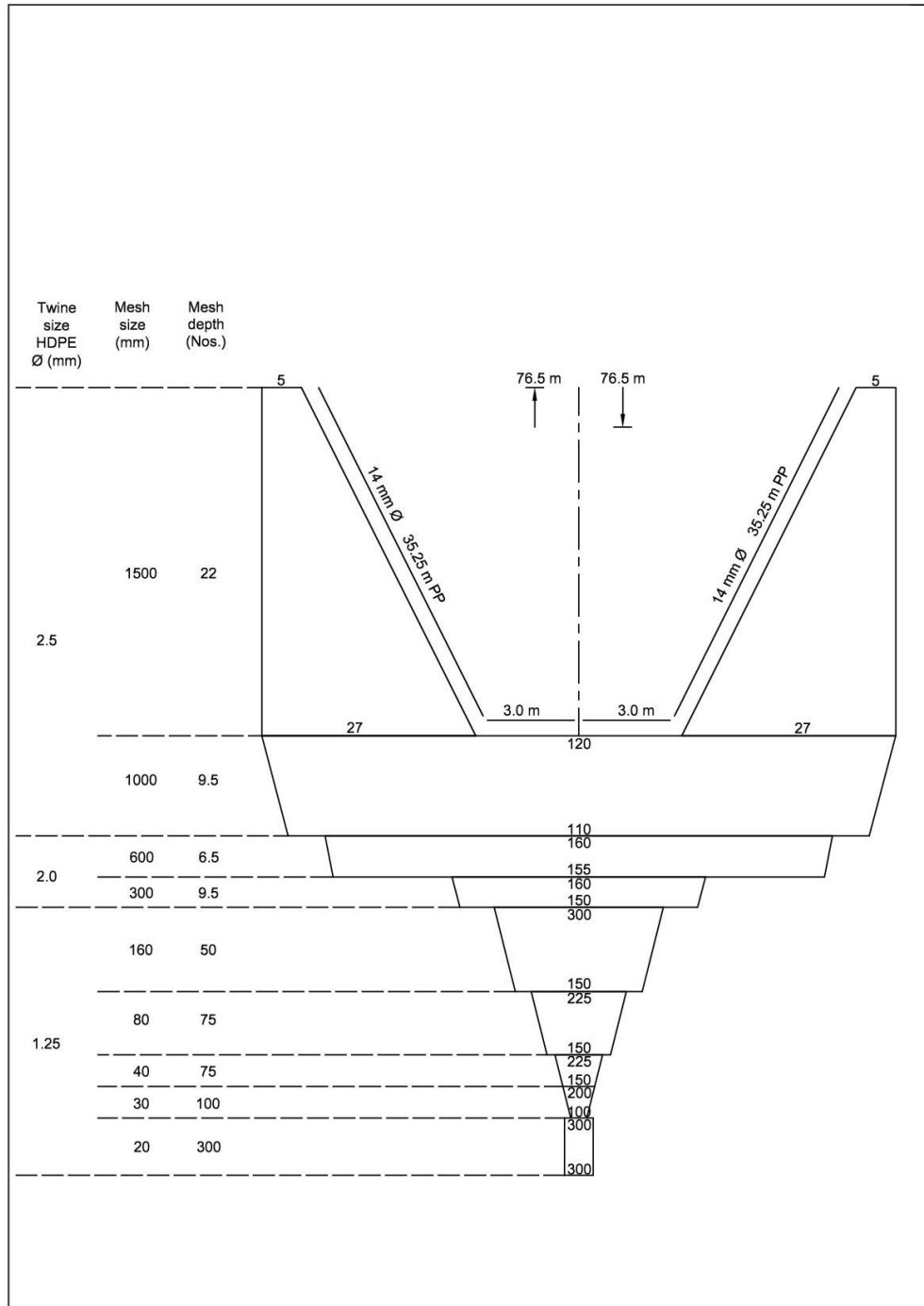

Fig.3.4 76.5 m Pomfret trawl (*Avoli vala*)

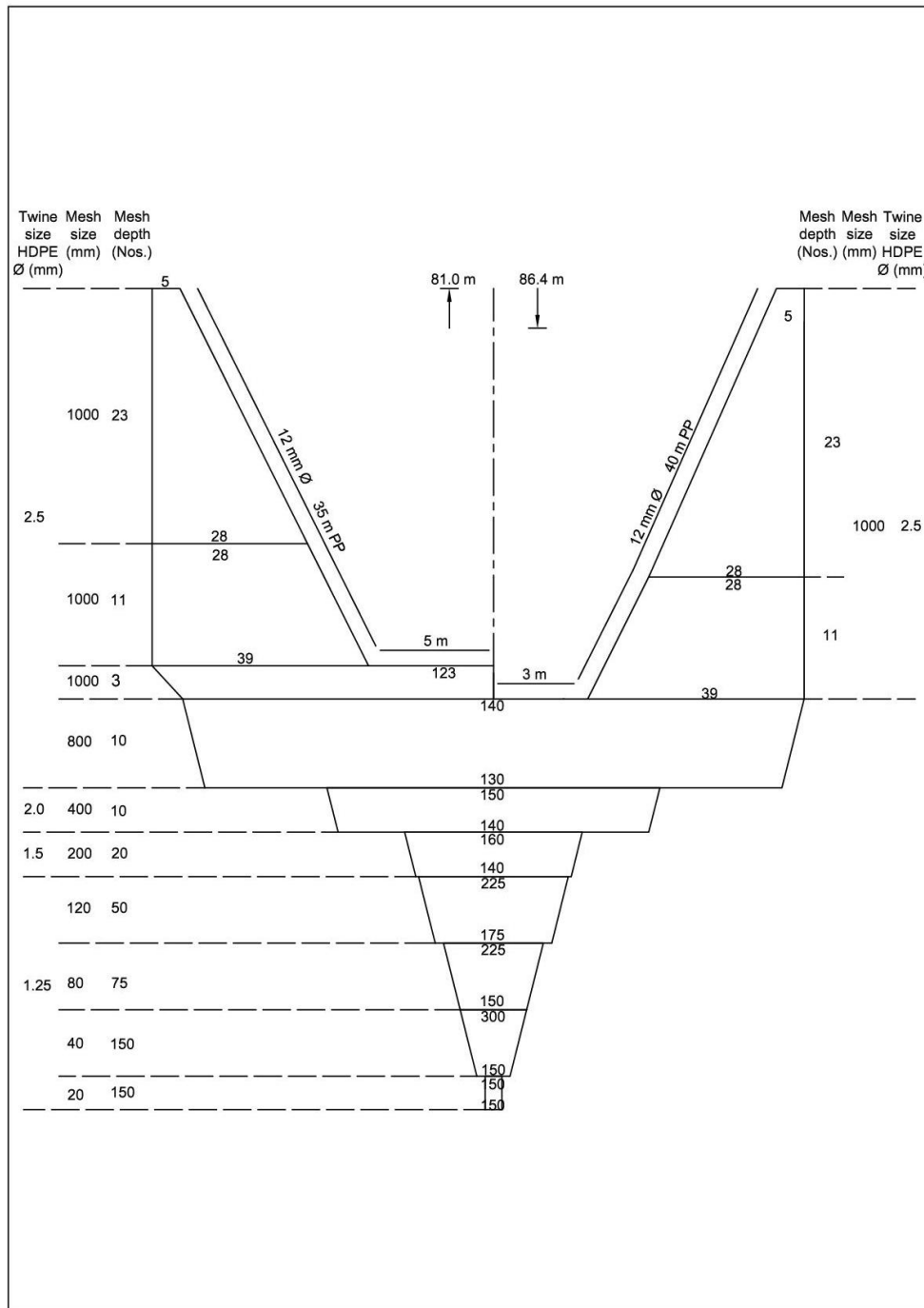

Fig.3.5 81.0 m Mackerel trawl (Ayala vala)

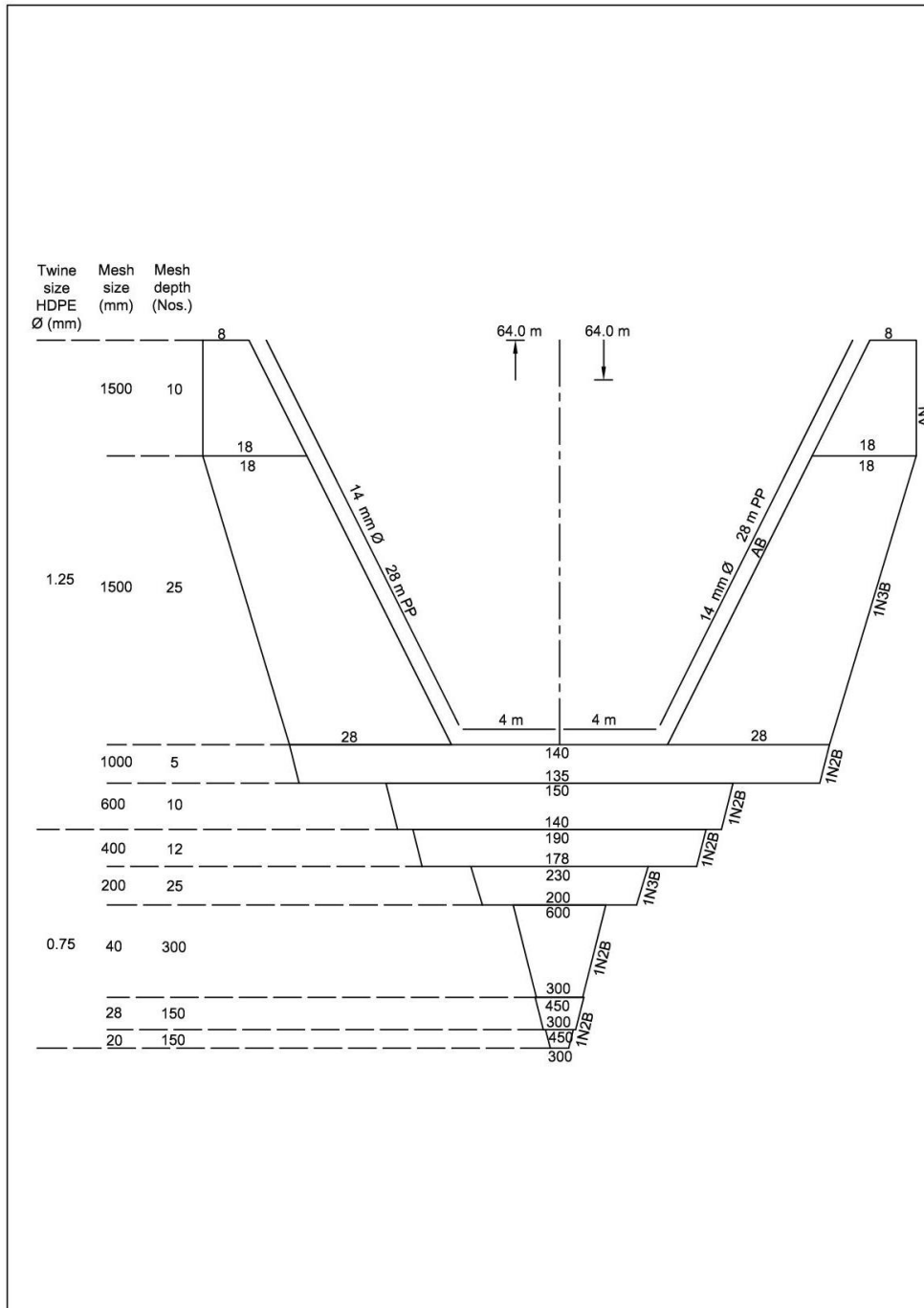

Fig.3.6 64.0 m Anchovy trawl (*Chooda vala*)

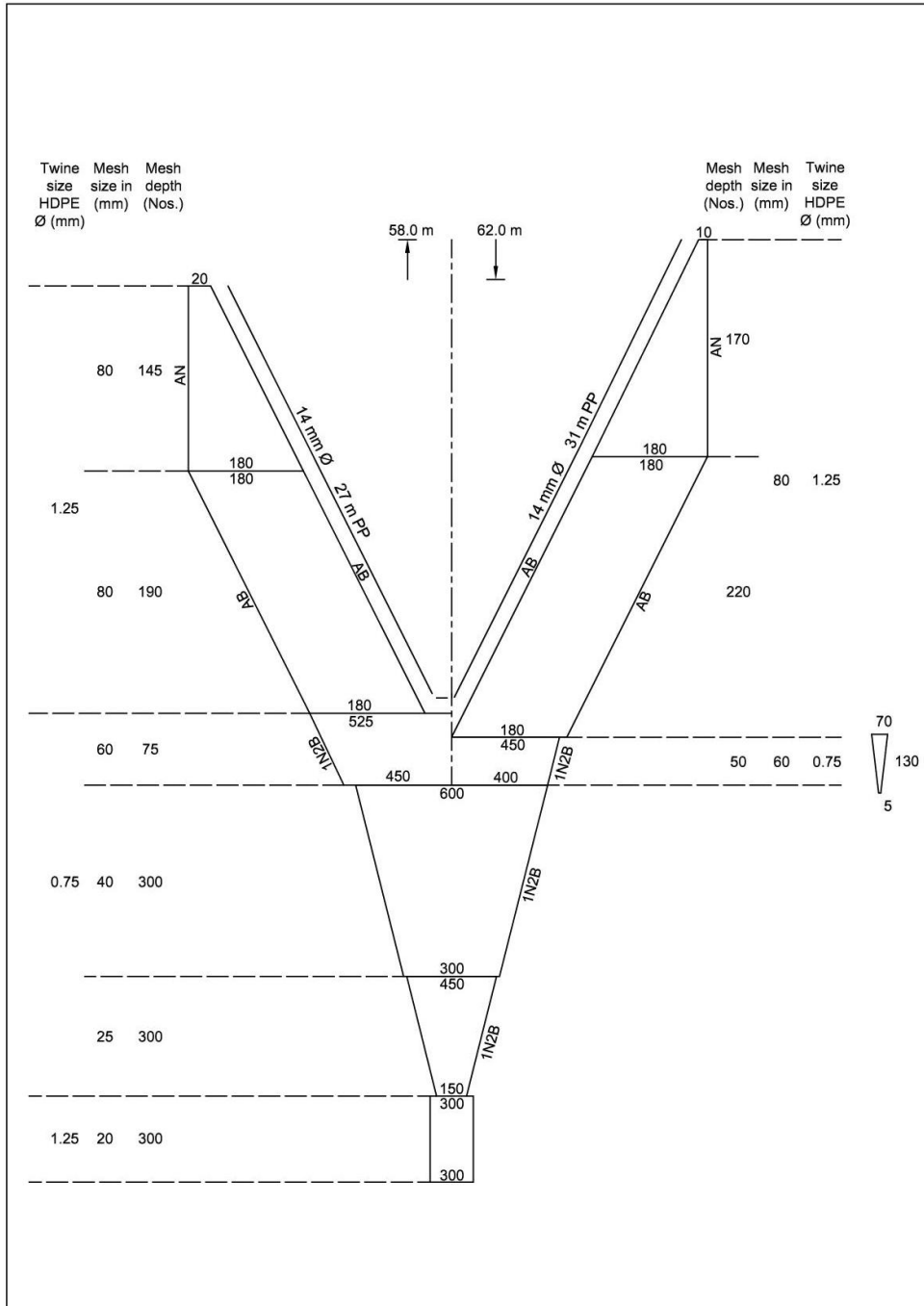

Fig.3.7 58.0 m Fish trawl (*Meen vala*)

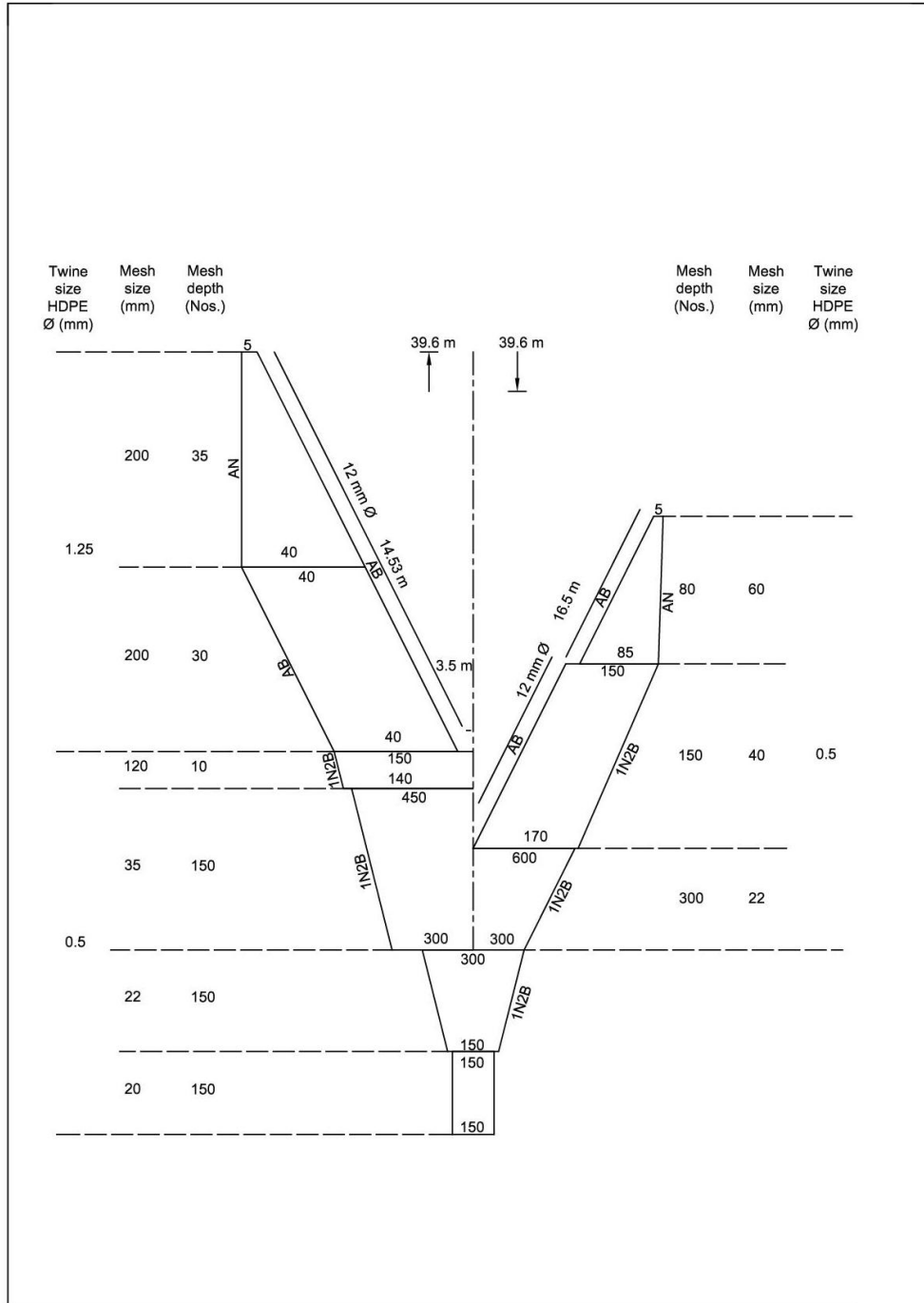

Fig.3.8. 39.6 m Flat fish trawl (*Manthal vala*)

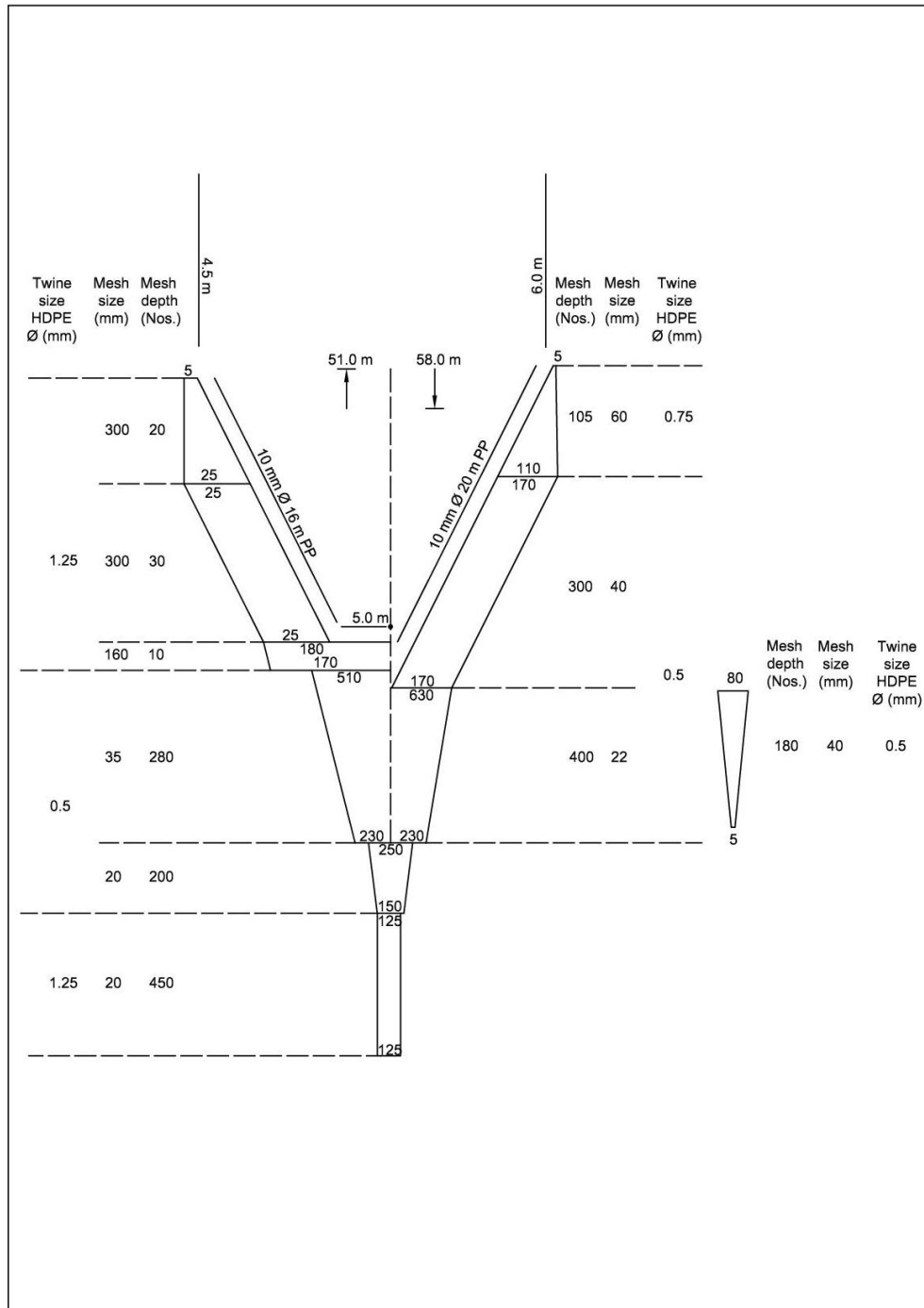

Fig.3.9 51.0 m Shrimp trawl (*Poovalan vala*)

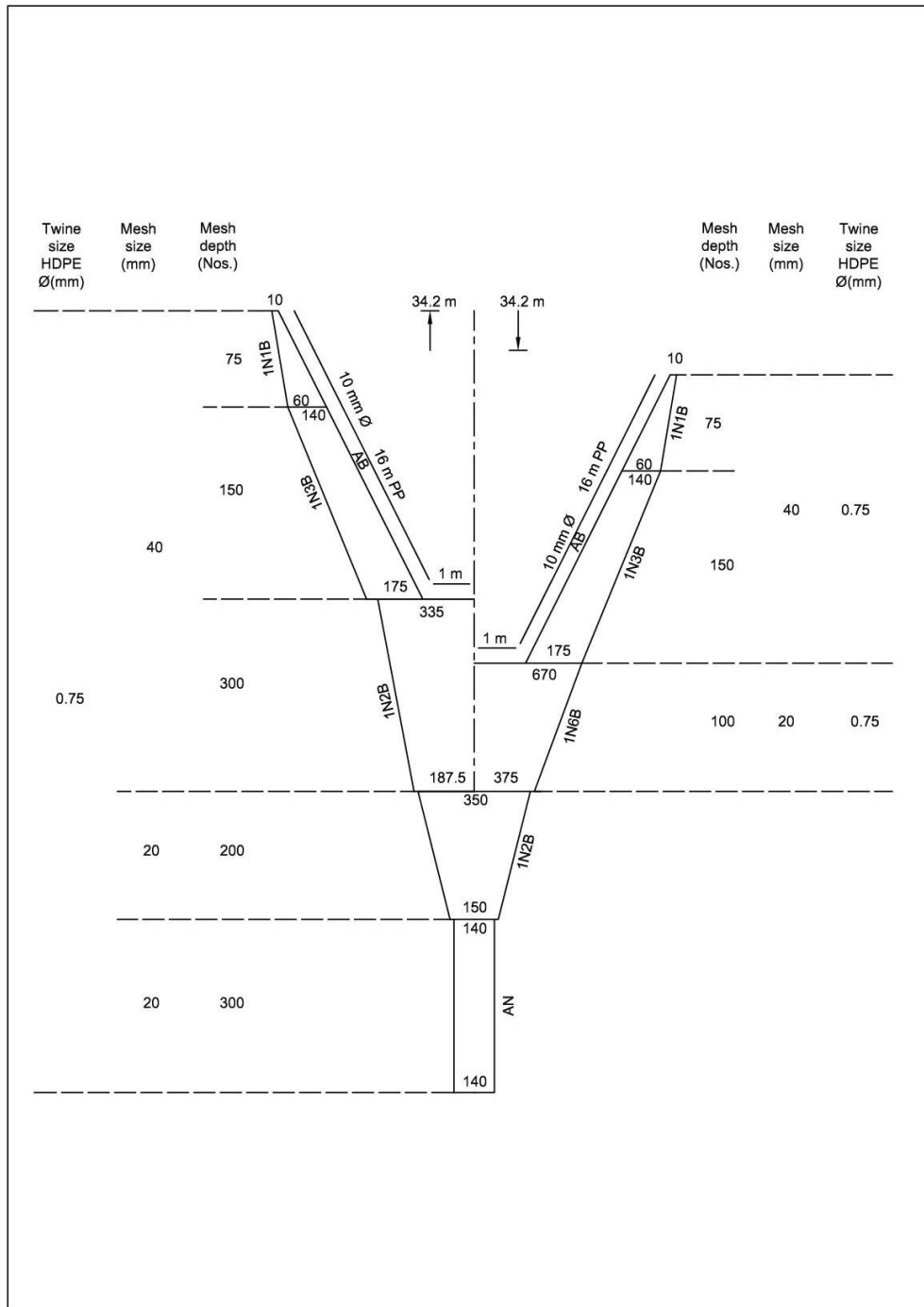

Fig.3.10 34.2 m Shrimp trawl (*Karikkadi vala*)

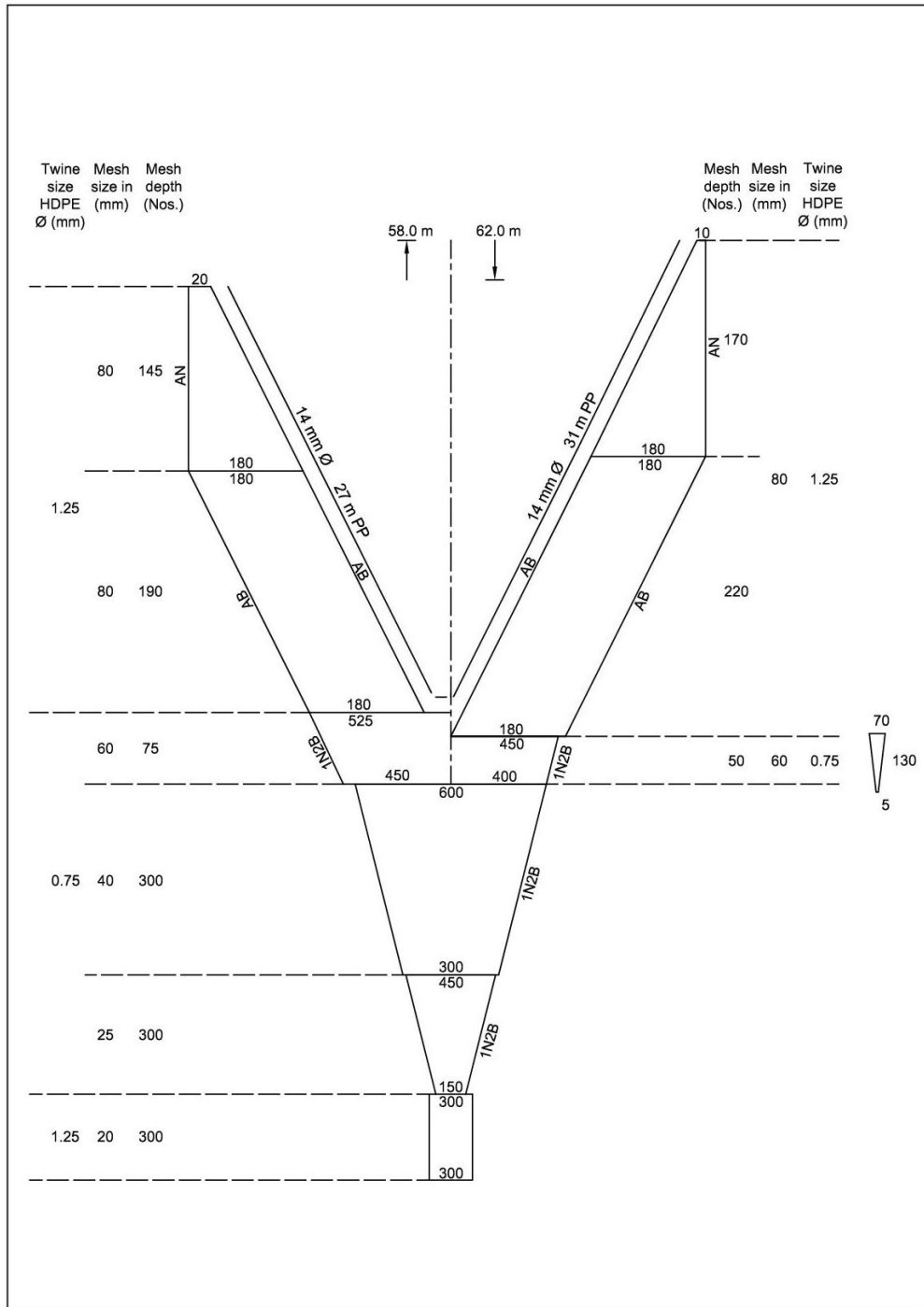

Fig.3.11 58.0 m Shrimp trawl (*Naran vala*)

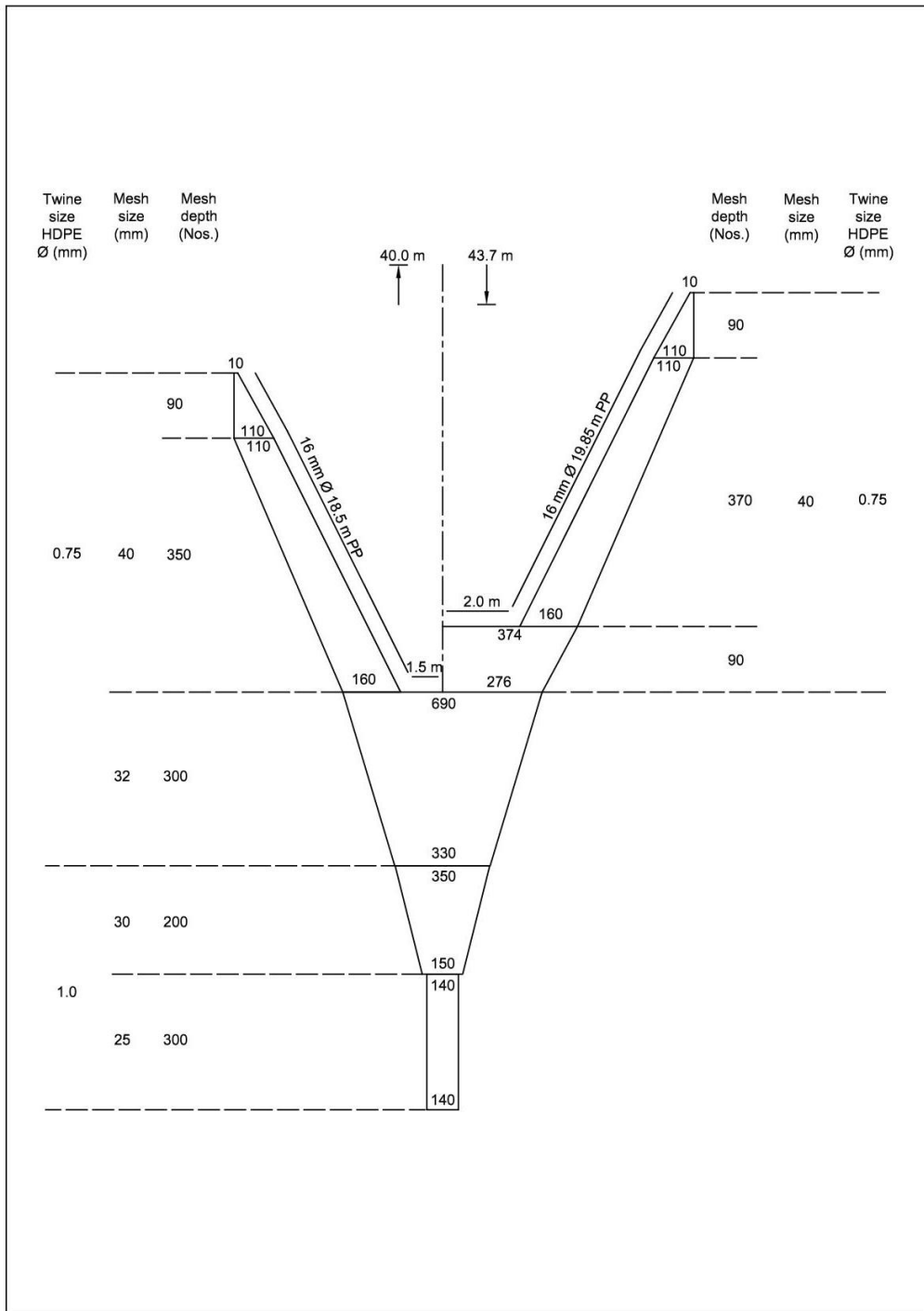

Fig.3.12 40.0 m Deep sea shrimp trawl (*Pullan vala*)

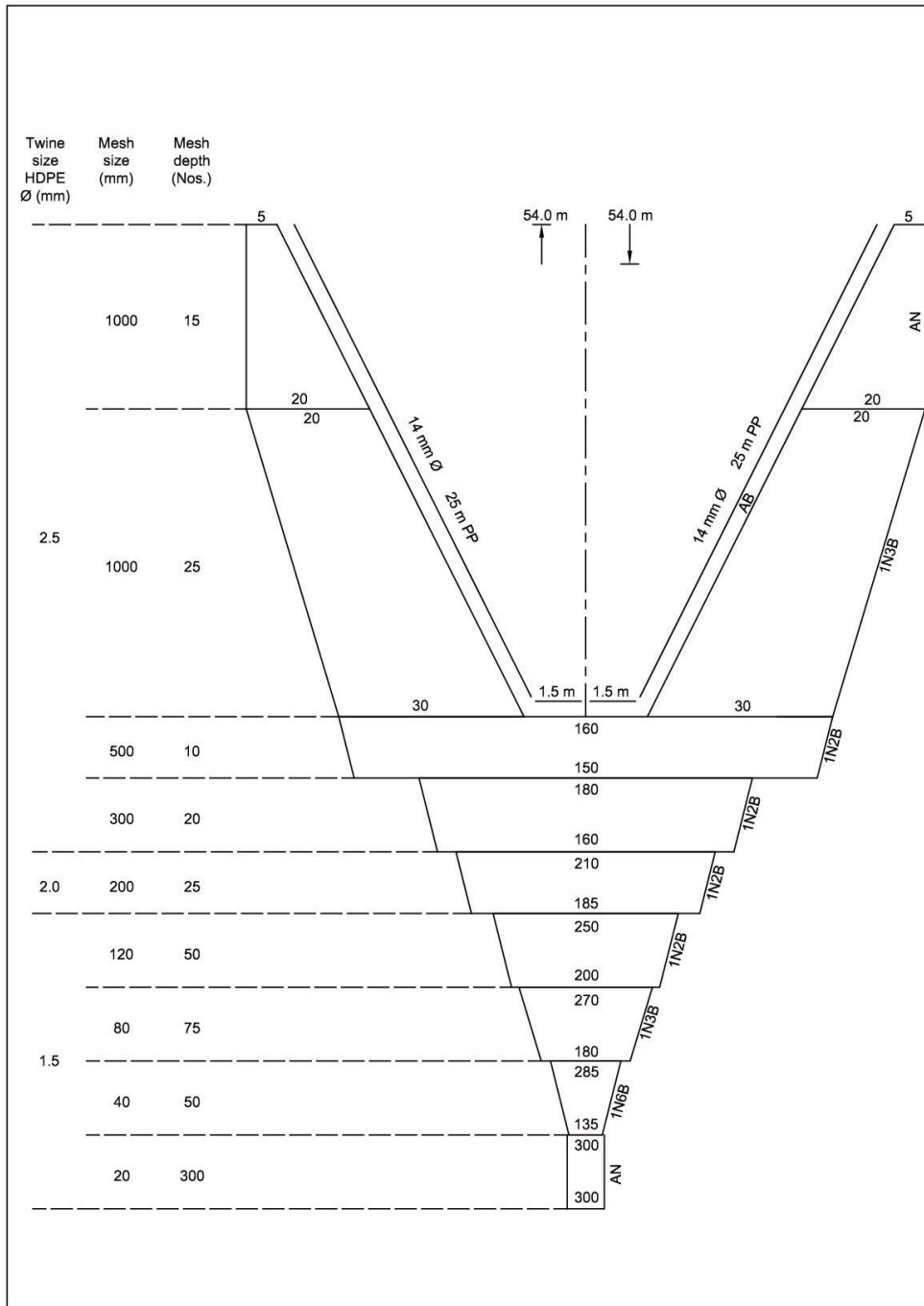

Fig.3.13 54.0 m Cuttle fish trawl (*Kanava vala*)

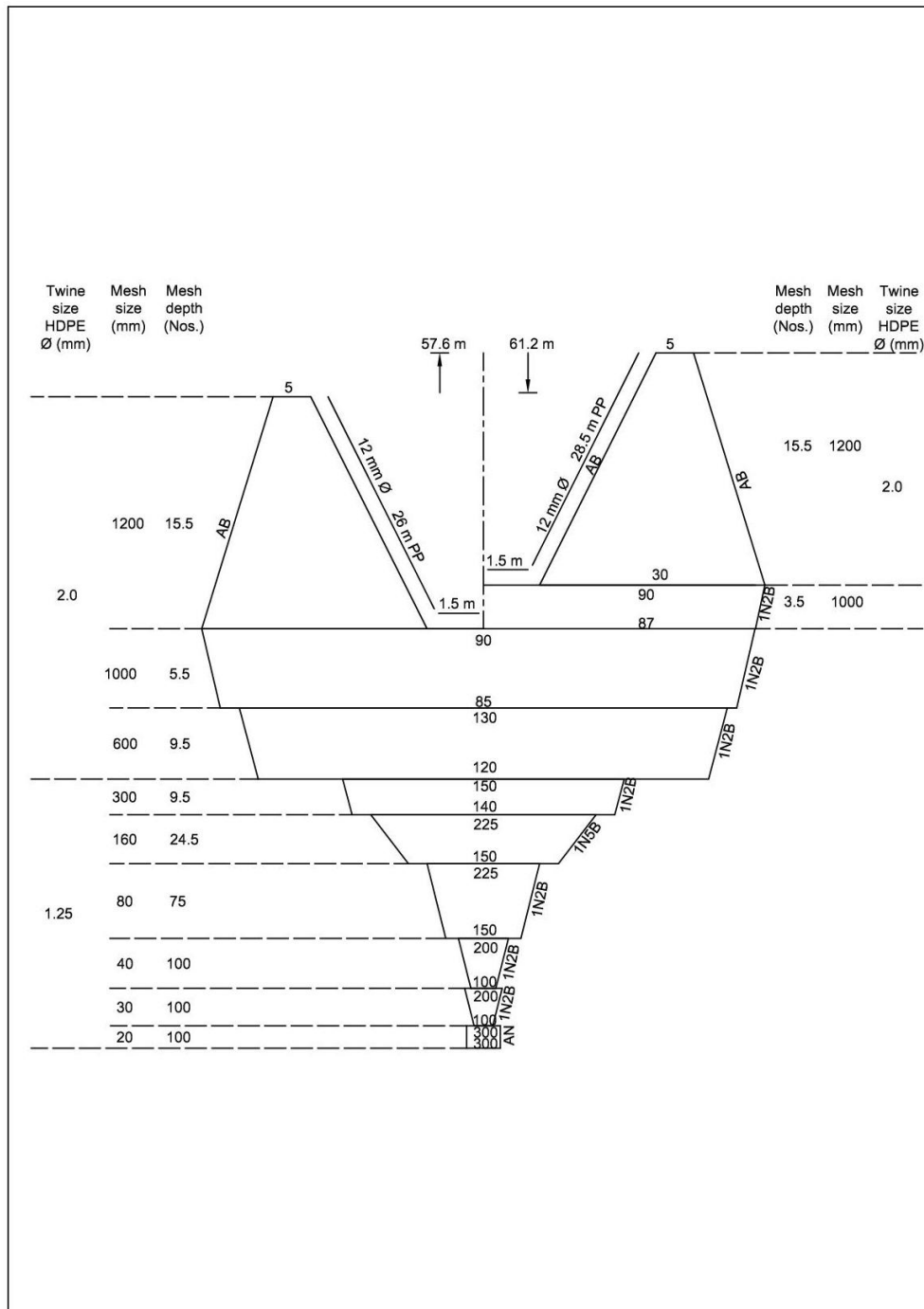

Fig.3.14 57.8 m Squid trawl (*Koonthal vala*)

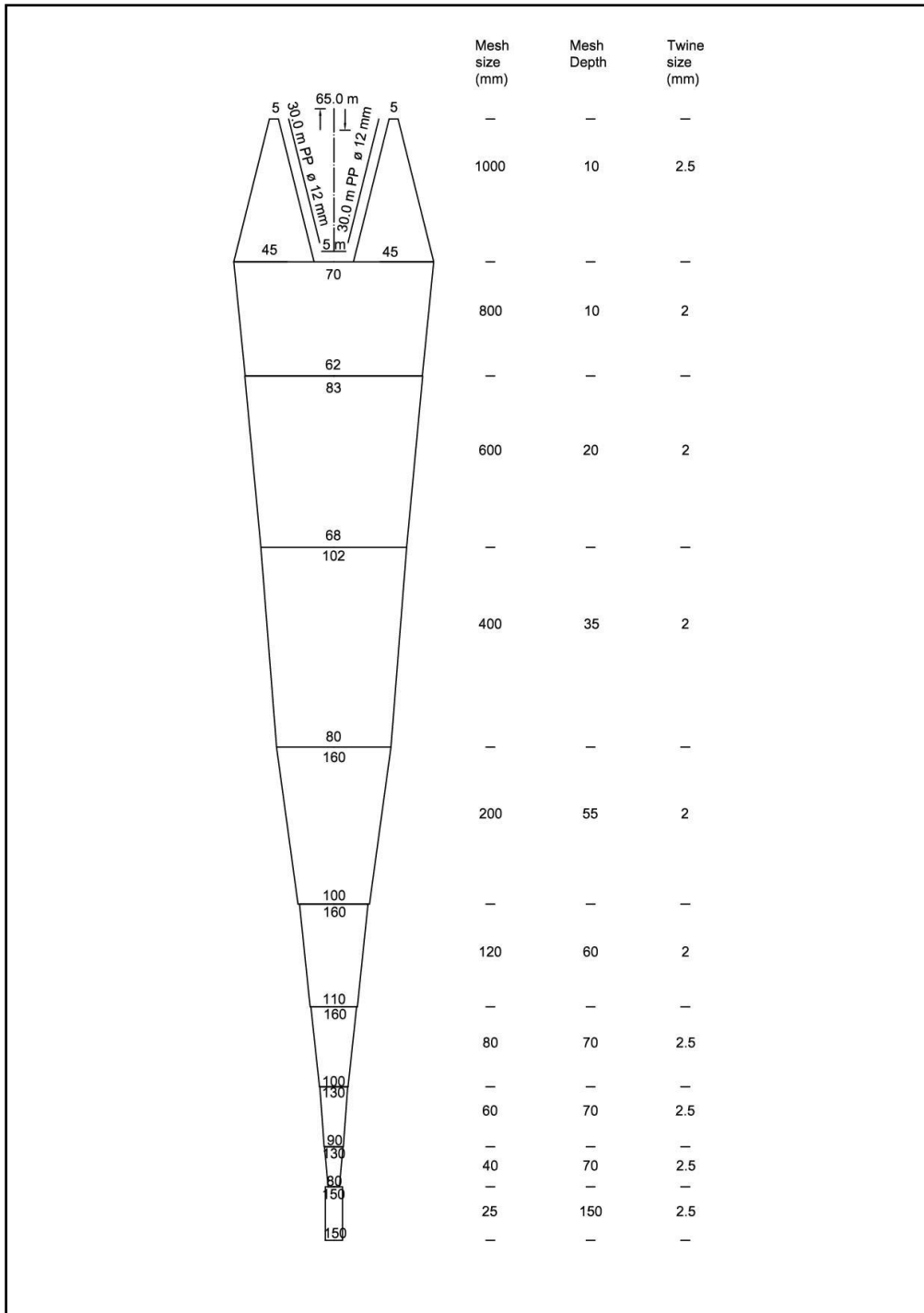

Fig.3.15 65.0 m Octopus trawl (*Octopus vala*)

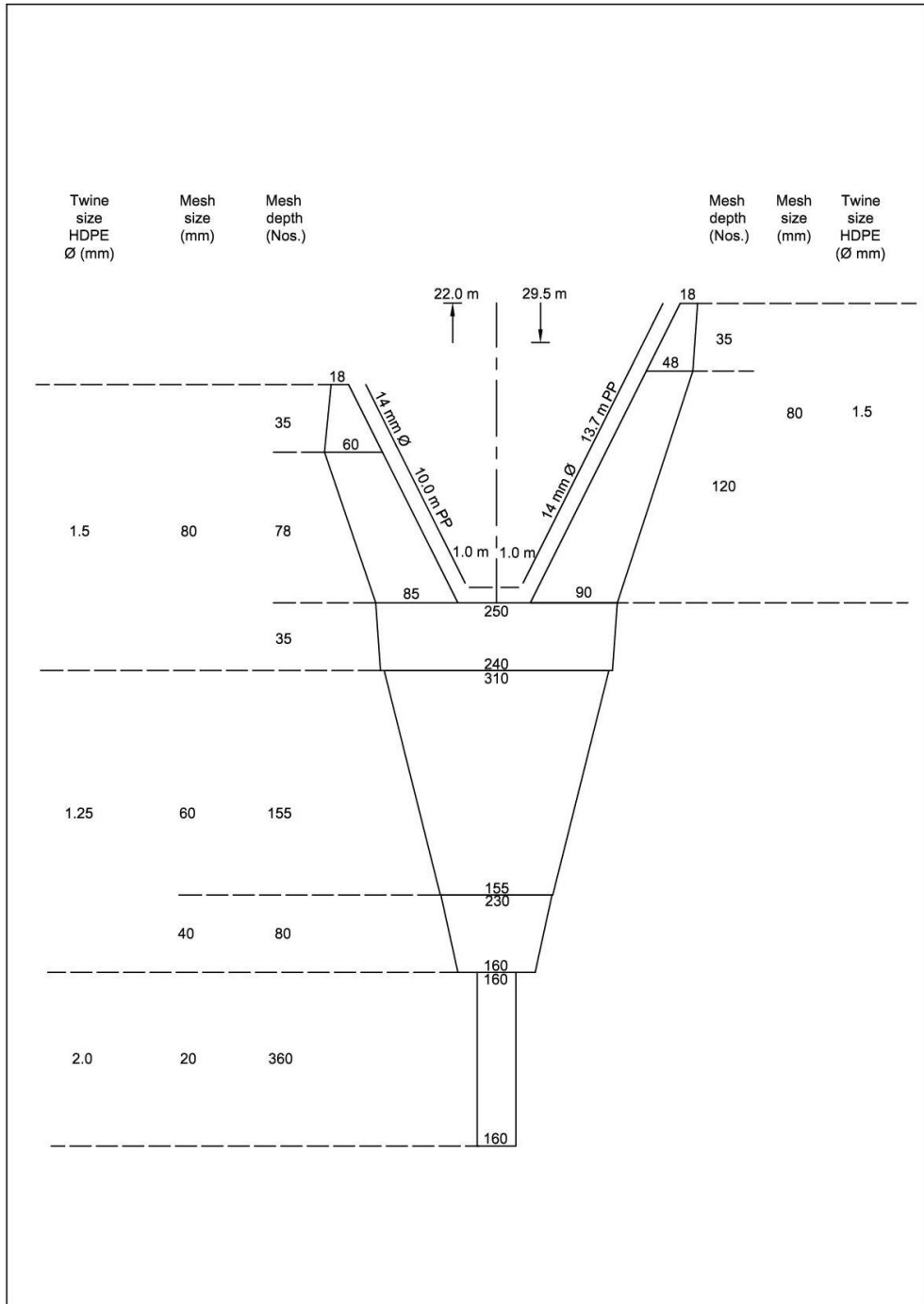

Fig.3.16 22.0 m Whelk trawl (*Chanku vala*)

Plate 1 ~ Mechanised trawlers, Kerala



A small trawler



A medium trawler



A large trawler



A very large trawler

Plate 2 - Trawl net and accessories used in mechanised trawlers, Kerala



Trawl nets carried onboard



Wooden otterboard



View of dorsal side of steel otterboard



View of ventral side of steel otterboard



Attachment of sinkers to the foot rope



Floats used in trawl nets

...❦❦❦...

TEMPORAL GROWTH IN MECHANISED TRAWL FISHERY OF KERALA

4.1 Introduction

Fishing is an art of catching aquatic organisms in which various techniques are being employed. Due to advancements in science and technology progressive changes occurred in fishing methods; in fishing craft, gear and operation among which introduction of trawling and trawlers is recognised as recent. Trawls coming under the category of dragged gears are an important fishing method throughout the world. Milestones helped in development of trawl fishery can be listed as introduction of high powered engines, mechanical hauling devices, acoustic equipment for fish finding and surveillance, radio navigation system, synthetic materials and the stern trawler (Boopendranath, 2000). Most recent advancement in trawl fishery recognised is the usage of multi rig trawls; two or more number of nets are mounted to a pair of otterboards, in which the drag will be shared by both the nets. Advances in instrumentation technology like acoustic equipment for fish finding and navigation, global positioning system (GPS), communication devices and radar increased the safety and efficiency of fishing.

From the time immemorial, sea fishing has been an occupation among coastal people of India. A meaningful move in Indian marine fisheries was mechanisation taken place in 1950s which gave the fishing sector an industrial status. Mechanisation made the fishing industry notable among the food production sectors and it caused accelerations in its progress. These

progressing steps paved way for building up of well advanced infrastructure both in harvesting and post harvesting areas. In addition to the development of infra structure, fisheries friendly government policies and increased demand for seafood in domestic and international markets also helped in dynamic growth in marine capture fisheries. But unscientific approaches in the sector led to over capacity in Indian fishing fleet (Sathianandan *et al.*, 2008). In India there are 194490 marine fishing crafts among which 37% is mechanised, 37% is motorized and remaining 26% is non-motorised (CMFRI, 2012). Existing mechanised and motorised vessels of the country is already in excess by a factor of 3.8 and 4.8 respectively (Baiju *et al.*, 2012).

Kerala has been in the forefront in absorbing the innovations and evolving new technologies among the maritime states of India. Increased demand for seafood in international market made intensification of mechanisation in marine fishing sector of the state which resulted in over all increment in fishing vessel size, size of gear and extension of fishing grounds. Due to these changes the state marine fisheries have become more advanced and complex. One of the most eminent features in the growth of marine fishery of the state is introduction of mechanised trawling. Mechanised trawlers were introduced for exploiting beyond the traditional fishing grounds where plenty of resources are available. Initially trawling was aimed at catching shrimps which then diversified to finfish and cephalopods. These diversification in technologies and easiness in exploitation compared to other systems gained popularity which attracted entrepreneurs to invest in the sector more than fishermen and it led to an organized and complex fishery. All these resulted in an enormous increase in the number and size of trawlers with commensurate growth in size of trawl net. Currently the state possesses highly dense mechanised fishing fleet which causes unhealthy competitions in the sector.

Mechanised trawlers in Kerala were introduced as part of the Indo-Norwegian project (INP) in collaboration with CIFT (Gnanadoss, 1977; Gulbrandsen, 1984; Gulbrandsen & Anderson, 1992; Verghese, 1998; Ravindran & Baiju, 1998 and Pillai *et al.*, 2000). Since its introduction in 1950s trawl system have significantly progressed in both design and performance (George *et al.*, 1980; Mukundan & Hameed, 1993; Verghese, 1998 and Thankappan, 2000). As a result of the over proliferation in number of trawlers, in 1985 Kalawar Committee has brought recommendations to restrict the number of trawlers in the state up to 1145. Nevertheless, it has grown over years and reached 3678 in 2010. The increased demand for shrimps and cephalopods in international market accelerated the over growth in the trawling sector which ended up in excess capacity and over exploitation. Trawl nets also underwent significant changes in course of time in its dimension and other design parameters. The increasing contribution by trawlers to the marine fish landing of the state is a result of this proliferation. Accordingly the fuel consumption and investment also got accelerated which has led to decreased economic viability.

The final result of all these processes is the accelerated growth and changes in all aspects of trawl fishing system wherever possible. Changes and up gradation is a common phenomenon in size, number and engine power of vessels, size of gear and its technical specifications. An evaluation of changes in size of trawler and its engine power in Kerala till 2012 has been undertaken by Ravi *et al.* (2014). However a complete analysis on the changes occurred in the trawling system of the state is lacking. Thankappan (2000) made investigations on changes in trawl fishery of Kerala and specified that changes occurred in size, design, type of material and operation of trawling systems since its introduction. The chapter aims to throw light on changes and growth

occurred in the sector which has to be carefully noticed for prevention of over growth and excess capacity in the sector.

4.2 Material and methods

The data obtained from the extensive survey in the fishing harbours and fish landing centers of the state for this doctoral programme are considered as present data. Secondary data are collected from other publications such as Kristjonson (1967), John (1996), Jyothilal (1998), Kurup & Radhika (2007), Gibinkumar (2008), CMFRI (1981, 2012), Ravi *et al.* (2014) and Edwin *et al.* (2014a).

4.3 Results and discussion

An analysis of the changes occurred with time in the mechanised trawl fishery since its introduction is delineated. It is observed that there has been a drastic increase in the size of gear with a commensurate increase in number and size of the fishing vessel and horsepower of engine. Even though continuous data is not available and the frequency of available data is very less, analysis shows critical changes and a tremendous growth in the fishery. Changes have taken place over the years in every components of the system; trawler, trawl net and operation, but quantification is possible in only few aspects. Quantification of changes occurred in number, size and engine power of trawlers and their percentage contribution, size and dimensions of trawl nets have been carried out. Various studies conducted on the technical specifications of trawling system are collected and an analysis and comparison with the present scenario is given.

4.3.1 Growth in trawlers

The first experience of trawling in Kerala was in 1955 in off Malabar coast with an experimental trawler of 6.6 m LOA, a wooden trawler powered with 10 hp engine. Trawling on commercial level was introduced as part of Indo-Norwegian project (INP) in 1957 (Pillai *et al.*, 2004). INP in association with ICAR-Central Institute of Fisheries Technology (ICAR-CIFT) has introduced and popularised six designs of trawlers with length overall ranging from 7.62 m to 17.52 m. Mechanisation of country craft was also a method adopted for popularisation of mechanisation among fishers (Verghese, 1998). As the fishery gained popularity, it spread to all areas of the state and increased demand for shrimps in domestic and international markets paved way for its popularisation. By the time, trawling has been recognised as the most efficient and economic method in catching shrimps which attracted more fishermen and entrepreneurs to the sector which resulted in earning an industrial status to the sector. In the course of time, fishermen started to increase the size of trawlers according to their need and more trawlers are being constructed. These developments forcefully made changes in the system over the time which made government to bring regulations. Trawl ban period, codend mesh size regulation in Kerala Marine Fisheries Regulation Act (KMFRA), Kalawar Committee recommendations on fleet size of trawlers, restriction in size of trawler by Government of India, etc are some examples. Vijayan *et al.* (2007) also recognised mesh size regulation as a step towards reduced overfishing in Indian fisheries. Mini trawls operated by motorized country crafts were an innovation in trawling sector of Kerala (Pillai *et al.*, 2000) which is a part of motorised sector.

Trawlers dominated among the mechanised fishing fleet of Kerala since its introduction. During 1980s number of trawlers in Kerala was 745

contributing 3% to total fishing fleet and 76% to mechanised fishing fleet (CMFRI, 1981). During 2005 number of trawlers in the state has grown to 3982 contributing 14% to the total fishing fleet and 72% to the mechanised fishing fleet (CMFRI, 2006). The contribution of trawlers to the mechanised fishing fleet of Kerala during 2010 is 78% (CMFRI, 2012) and to the total fishing fleet is 17% (Fig.4.1).

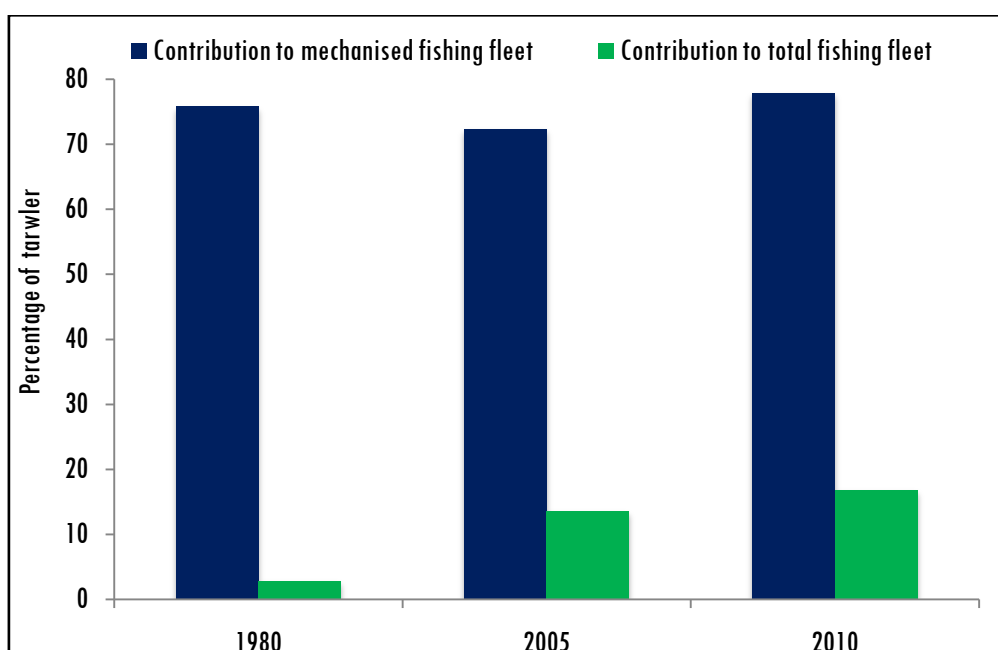

Fig.4.1 Percentage share of trawlers in mechanised fishing fleet and total fishing fleet of Kerala

During early 60s there were only 150 mechanised boats in Kerala among which most of them were trawlers (Scariah *et al.*, 1999) and another hundreds have introduced in the late sixties and seventies (Sehara & Kanakkan, 1993). According to the first available quantified estimates, there were only 745 trawlers along Kerala coast in 1980 (CMFRI, 1981). Jyothilal (1998) reported there were 4000 trawlers in Kerala during the period contributing 55% to the mechanised fishing fleet of the state and they were

operating within 50 m depth zone. Afterwards, number of mechanised trawlers in Kerala has incremented to 4960 during 2000-01 (Kurup & Radhika, 2007). Among the 4960 trawlers, more than 50% of the trawlers were based at Quilon district followed by Ernakulam (31.25%) and Kozhikode (11.29%) and the rest is from other districts such as Alappuzha, Thrissur, Malappuram, Kannur and Kasargode. According to CMFRI Marine Fisheries Census (CMFRI, 2006), there were 3982 trawlers in the state in 2005, contributing 72% to the mechanised fishing fleet. During 2010 there were 3678 trawlers in the state. The decline in number of trawlers since 2005 is an impact of increment in size of trawlers. In other words, instead of constructing more number of smaller vessels, fishermen prefer to construct bigger vessels lesser in number. Termination of less efficient fishing units of all category of fishing which are forced to go out has been stated by Sathiadhas & Narayanakumar (2001). Hence as shown in Table 4.1 and Fig.4.2 number of trawlers in Kerala has been increased five times since its introduction.

Table.4.1 Number of trawlers in Kerala

Year	No. of trawlers	Source
1980	745	CMFRI, 1981
1998	4000	Jyothilal, 1998
2001	4960	Kurup & Radhika, 2007
2005	3982	CMFRI, 2006
2010	3678	CMFRI, 2012

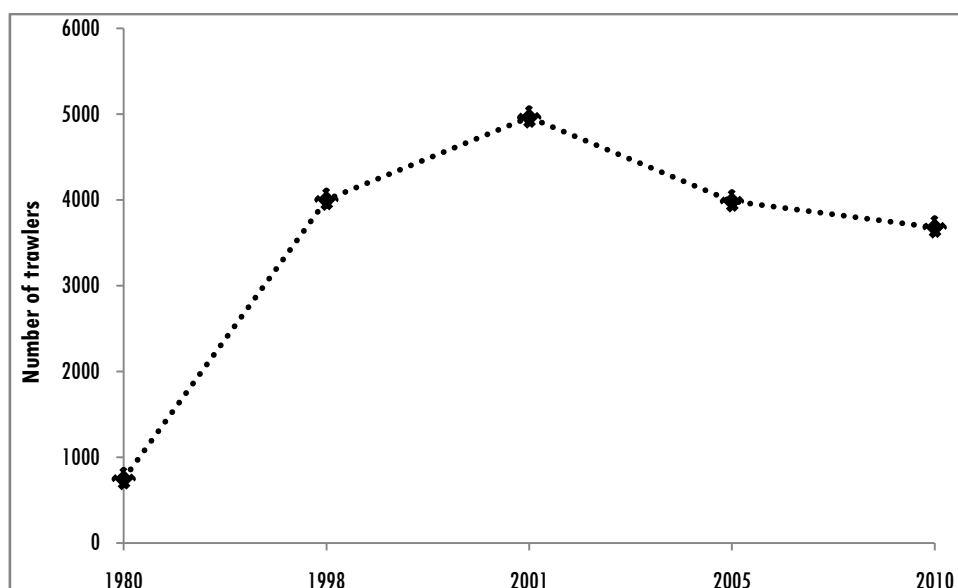

Fig.4.2 Growth in number of trawlers

Main benefits of mechanisation include widening in area and depth of exploitation and use of advanced, efficient and large sized gears. These benefits resulted in increment of vessel size for carrying larger nets and for increased storage space to occupy large catch. Size of trawlers or any kind of fishing vessels are expressed in terms of their length over all (L_{OA}). First record on size of trawlers, the trawler which has been used for shrimp trawling in 1955 was 6.6 m in L_{OA} (Kristjonson, 1967). Later trawling gained popularity and spread across the state and several studies have been conducted on the similar aspect. John (1996) has reported the maximum L_{OA} of trawlers in Kerala coast during 1980 as 10 m and 16.8 m during 1995-96. Maximum length of trawlers during 2001 was reported as 21.3 m (70 feet) when Shakhikulangara harbor recorded higher number of trawlers (Kurup & Radhika, 2007). In 2008, studies on trawling system of Quilon and Central Kerala were conducted by Sabu (2008) and Gibinkumar (2008) respectively and both of them reported 21.6 m as the maximum L_{OA} of trawlers. Ravi *et al.*

(2014) conducted studies on structural changes of trawlers in Kerala coast and reported 23 m as the maximum L_{OA} during 2012. Edwin *et al.* (2014a) conducted survey on marine mechanised fishing systems of Kerala and reported 28 m as the maximum L_{OA} of trawlers in the state. The present study on trawlers in the state revealed that 33.5 m is the maximum length overall of trawlers. Parallel to number of trawlers, size of trawlers in the state also grown five times or more since introduction (Table 4.2. & Fig.4.3).

Table 4.2 Growth in size of trawlers in Kerala

Year	Max. L_{OA} (m)	Source
1955	6.6	Kristjonson 1967
1980	10	John, 1996
1996	16.8	John, 1996
2001	21.3	Kurup & Radhika 2007
2008	21.6	Gibinkumar, 2008 & Sabu, 2008
2012	23	Ravi <i>et al.</i> , 2014
2014	28	Edwin <i>et al.</i> , 2014a
2017	33.5	Current study

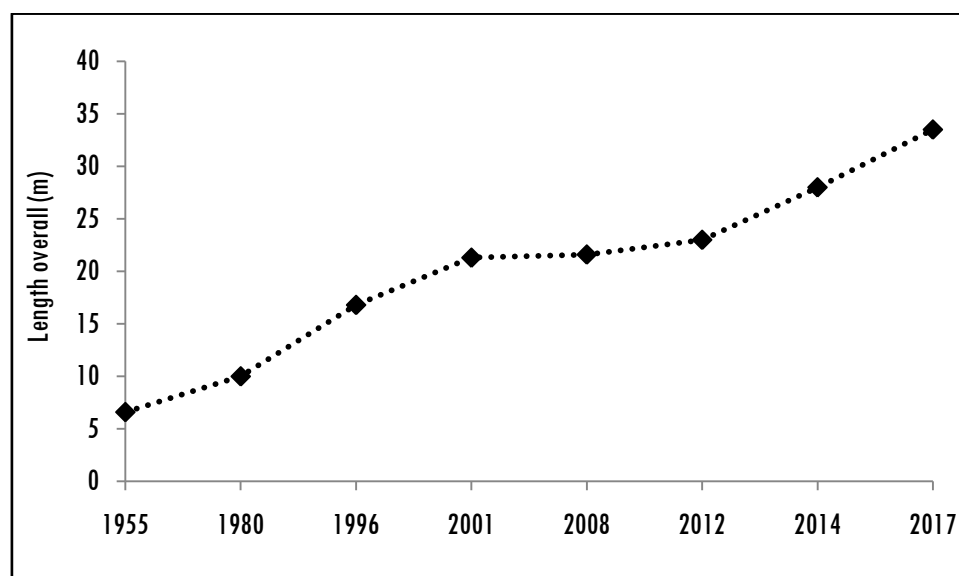
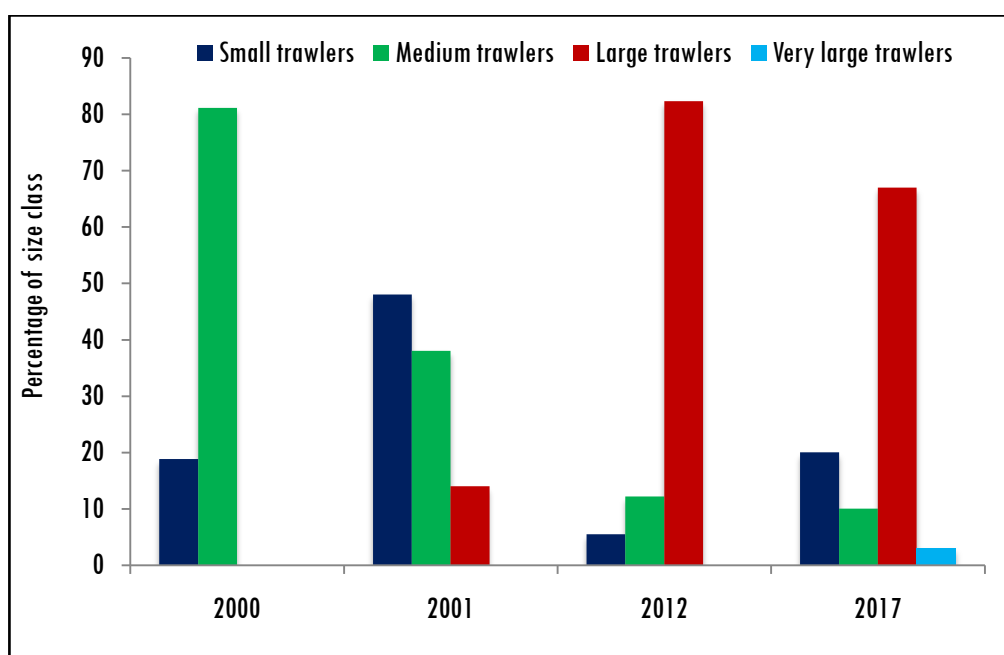

Fig.4.3 Growth in size of mechanised trawlers in Kerala

Another noteworthy change occurred in trawlers is contribution of different size class to the total number of trawl fishing fleet in the state. Going through the history of commercial trawlers in Kerala, it is understood that till 1980s there were only small trawlers. But size of trawlers kept increasing in order to facilitate more storage space and endurance. Medium sized trawlers (12.0 to 16.0 m L_{OA}) were first reported in 1996 (John, 1996). Until 2000 only small and medium trawlers were there in Kerala. First data available on percentage contribution of trawlers is representing the year 2000 (Ravi *et al.*, 2014). During 2000, 18.8% small trawlers and 81.1% medium trawlers constituted the trawl fishery of the state. Large trawlers having L_{OA} 16.0 to 24.0 m was first reported in 2001 by Kurup & Radhika (2007). According to them during 2000 - 2001 there were 48% small trawlers, 38% medium trawlers and 14% large trawlers in the state. The race for fish has kept size of trawlers increasing. In 2012, there were 5.5% small trawlers, 12.2% medium trawlers and 82.3% large trawlers (Ravi *et al.*, 2014). The category, very large trawlers were lacking till 2014 and Edwin *et al.* (2014a) has reported the size of trawlers up to 28 m. But a quantified data on number of very large trawlers was lacking. At present maximum L_{OA} of trawlers reached 33.5 m and contribution of very large trawlers reached 3%. Large trawlers contributed maximum (67%) followed by small trawlers (20%), medium trawlers (10%) and very large trawlers (3%). Fishermen's urge for increased storage capacity and other benefits is the strong reason behind the proliferation of larger vessels. Small and medium trawlers are fast declining in number as construction of new such vessels rare. Contribution of large and medium trawlers is dominant and number of very large trawlers is increasing at present. The change in percentage contribution of each size class is given in table 4.3 and Fig.4.4.

Table.4.3 Percentage contribution of different size class

Type of trawlers	2000	2001	2012	2017
Small trawlers	18.8	48	5.5	20
Medium trawlers	81.1	38	12.2	10
Large trawlers		14	82.3	67
Very large trawlers				3

**Fig.4.4** Percentage contribution of different size class of trawlers in Kerala during various years

4.3.2 Growth in engine power of trawlers

Engine power is found to be incrementing in accordance with the size of trawlers or in other words, engine power also increased in the proportion of size of trawlers. Engine power is increased mainly for providing sufficient speed for propulsion and gear handling. Competition among fishermen to reach the fishing ground as fast as possible as well as to bring and unload the catch at the earliest were the basic intention behind increase in engine power. The use of high powered engines by fishing vessels in Kerala have been

studied by Baiju *et al.* (2012) and they estimated optimum horse power for each length class of vessels. According to their study 20.0 m trawlers require only 250 hp engine but it is more than 450 hp at present.

Engine power of first shrimp trawler was 10 hp (Kristjonson, 1967). During 1980s it was reported that 7.5 hp was the maximum engine power used by trawlers in Kerala (John, 1996). Mukundan & Hameed (1993) reported that the maximum engine power of trawlers in Cochin coast was 13 hp during 1990s. After middle of 1990s it showed a tremendous increment in engine power of trawlers and maximum engine power in the state during 1996 was 148 hp (John, 1996). Ravi *et al.* (2014) stated that maximum horse power of trawler engines was 150 hp during 2000. During 2000-2001 period engine power up to 680 hp were installed exclusively for operation beyond 300 m depth for deep sea shrimps and cephalopods (Kurup & Radhika, 2007). Maximum engine power observed was 177 hp during 2008 (Gibinkumar, 2008 & Sabu, 2008). Ravi *et al.* (2014) reported 495 hp as maximum engine power used by trawlers in the state during 2012. Edwin *et al.* (2014a) conducted detailed study on trawlers of Kerala and reported the same. During the present study maximum engine power used by trawlers in the state is observed as 550 hp. Hence it can be concluded that since 1955, engine power of trawlers in the state showed 55 times growth (Table 4.4 & Fig.4.5).

Table.4.4 Engine power of trawlers along Kerala coast in different years

Year	Max. hp	Source
1955	10	Kristjonson 1967
1980	7.5	John, 1996
1993	13	Mukundan & Hameed, 1993
1996	148	John, 1996
2000	150	Ravi <i>et al.</i> , 2014
2008	177	Gibinkumar, 2008 & Sabu, 2008
2012	495	Ravi <i>et al.</i> , 2014
2014	495	Edwin <i>et al.</i> , 2014a
2017	550	Present study

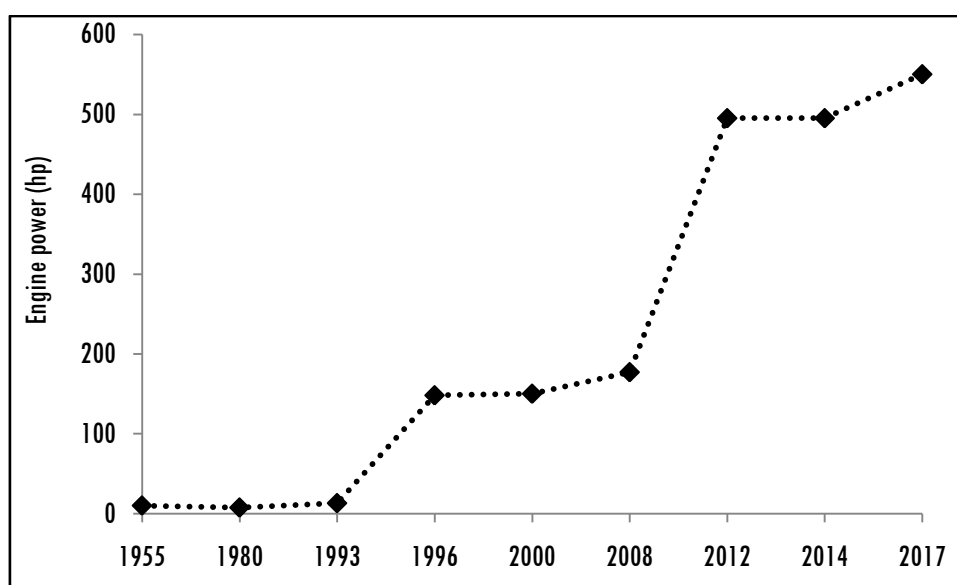

Fig.4.5 Growth in engine power of trawlers

4.3.3 Growth in trawl net

Trawl nets underwent numerous changes since its introduction in 1950s; size, design, rigging and mode of operation are changing frequently. Shrimp trawls were the first trawl nets introduced in Kerala as all over the world and later fish trawls were introduced. All other resource specific trawls introduced only after several years of the introduction of the fish trawl. Large mesh trawls is the latest development whereas the codend mesh size remained more or less same. Large mesh trawls, rope trawls, usage of thinner twines, etc are examples for changes in trawl nets. The accessories are also changing accordingly, adoption of 'V' form otter boards, steel wire ropes for warps, etc. are examples. During 1980, 1454 trawl nets were there in Kerala, approximately each vessel carrying two nets onboard (CMFRI, 1981). At present it has been raised to 12 trawl nets onboard a trawler, which shows a six fold increase. Changes occurred in trawl nets can be assessed quantitatively only in terms of head rope length and mesh size.

Size of trawl nets is usually indicated as its head rope length and it is determined by the mesh size and number of meshes at the wing end trawl net. Head rope is tied on the edges of the wings in the upper panel and from which the floats are hanged. As dimensions such as mesh size or number of meshes are increased, head rope length gradually increased. The head rope length of first used trawl net in the state was only 9.6 m which was targeting shrimps (Kristjonson, 1967). Mukundan & Hameed (1993) reported the maximum head rope length of trawl nets in Cochin as 27.5 m. John (1996) stated that maximum head rope length of trawl nets was 27 m in the state. A mid water trawl of maximum 54 m head rope length was reported from Central Kerala (Gibinkumar, 2008). Edwin *et al.* (2014a) reported 81 m as the maximum head rope length of trawl nets in the state. As per the survey conducted in 2017, maximum head rope length of trawl nets in the state is 145 m. Hence it can be concluded that head rope length of trawl nets increased 15 times since its introduction regardless the target resource (Table 4.5 & Fig.4.6).

Table.4.5 Maximum head rope length of trawl nets used along Kerala coast in different years

Year	HR length (m)	Source
1955	9.6	Kristjonson 1967
1993	27.5	Mukundan & Hameed, 1993
1996	27	John, 1996
2008	54	Gibinkumar, 2008
2014	81	Edwin <i>et al.</i> , 2014a
2017	145	Present study

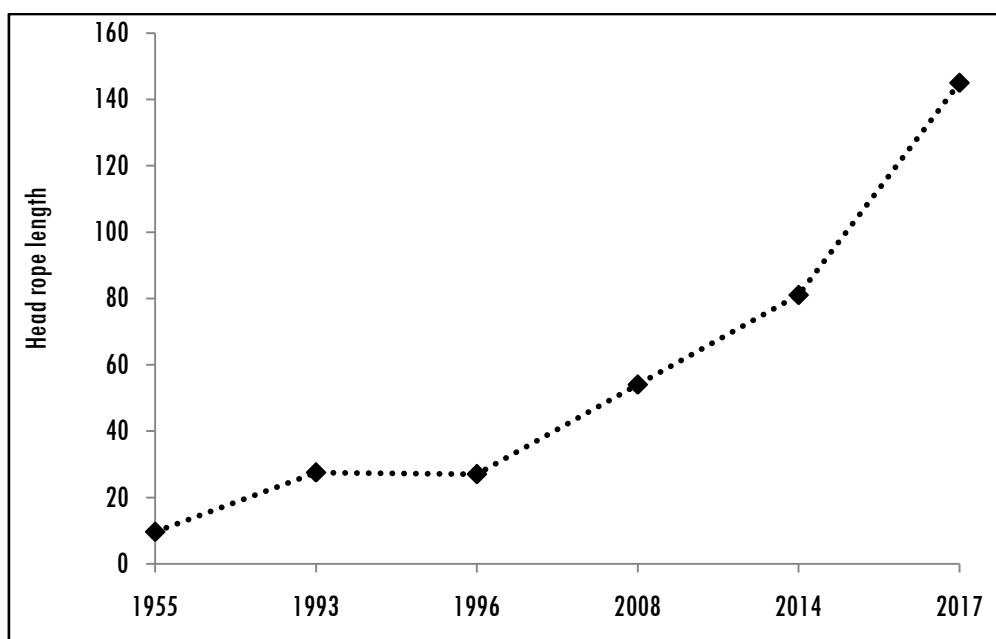

Fig.4.6 Growth in head rope length of trawl nets

Design details of trawl nets include shape of net, specifications of webbing used for fabrication such as mesh size and twine size, etc. Among these specifications, visible and measurable changes have occurred in mesh size of the webbing used for fabrication of the net especially at the wing end. Wing end mesh size is the factor which determines the target species and it also has a role in fuel consumption as large mesh will reduce the drag of trawl net (Vijayan *et al.*, 1992; Nayak & Seshappa, 1993; Broadhurst *et al.*, 2000 and Balash, 2012). During its initial stages there were only shrimp trawls which were fabricated usually with smaller meshes. As a result of the popularisation of trawl fishery to various regions of the state, mid water trawling came in to existence in the state and changes in wing end mesh size occurred accordingly. Recently trawl nets are diversified to capture cephalopods and gastropods also (Gibinkumar, 2008; Sabu, 2008; Edwin *et al.*, 2014a and Ravi, 2015). For reduced fuel consumption

and to attain more speed to catch fast swimming pelagic fishes like ribbon fish, wing mesh size has increased up to 10000 mm recently. First available data on the wing end mesh size of trawl nets is from Cochin coast, and it was 50 mm (Fig.4.8) which was a shrimp trawl (Mukundan & Hameed, 1993). John (1996) reported the maximum mesh size at the wing end as 160 mm for fish trawls (Fig.4.9) and 80 mm for shrimp trawls (Fig.4.10) among the trawl nets used by trawlers in Kerala. In 2008 the maximum mesh size at the wing end reported in the state was 1500 mm for fish trawls (Fig.4.11) and 50 mm for shrimp trawls (Fig.4.12) along central Kerala (Gibinkumar, 2008). Edwin *et al.* (2014a) reported 5000 mm as maximum mesh size at the wing end for fish trawls (Fig.4.13) and 300 mm for shrimp trawls (Fig.4.14). Hence it can be concluded that wing end mesh size of shrimp trawls has grown six times and that of fish trawls has grown over 60 times since 1990s in Kerala (Table 4.6, Fig.4.7).

Codend mesh size which is the most discussing element in trawl fishery of the state, always found to be less than restricted mesh size. During 2000-01 period, 16-20 mm was the codend mesh size in 76% of the trawl nets and 22% trawl nets was having codend mesh size of 20-24 mm (Kurup & Radhika, 2007). Now exclusive use of 20 or 25 mm mesh size for codend is observed regardless the type and design of trawl nets.

Table.4.6. Mesh size at the wing end of trawl during different years

Year	Type of trawl net	Wing end mesh size (mm)	Source
1993	Shrimp trawl	50	Mukundan & Hameed, 1993
1996	Fish trawl	160	John, 1996
1996	Shrimp trawl	80	John, 1996
2008	Fish trawl	1500	Gibinkumar, 2008
2008	Shrimp trawl	50	Gibinkumar, 2008
2014	Fish trawl	5000	Edwin <i>et al.</i> , 2014a
2014	Shrimp trawl	300	Edwin <i>et al.</i> , 2014a
2017	Fish trawl	10000	Present study
2017	Shrimp trawl	300	Present study

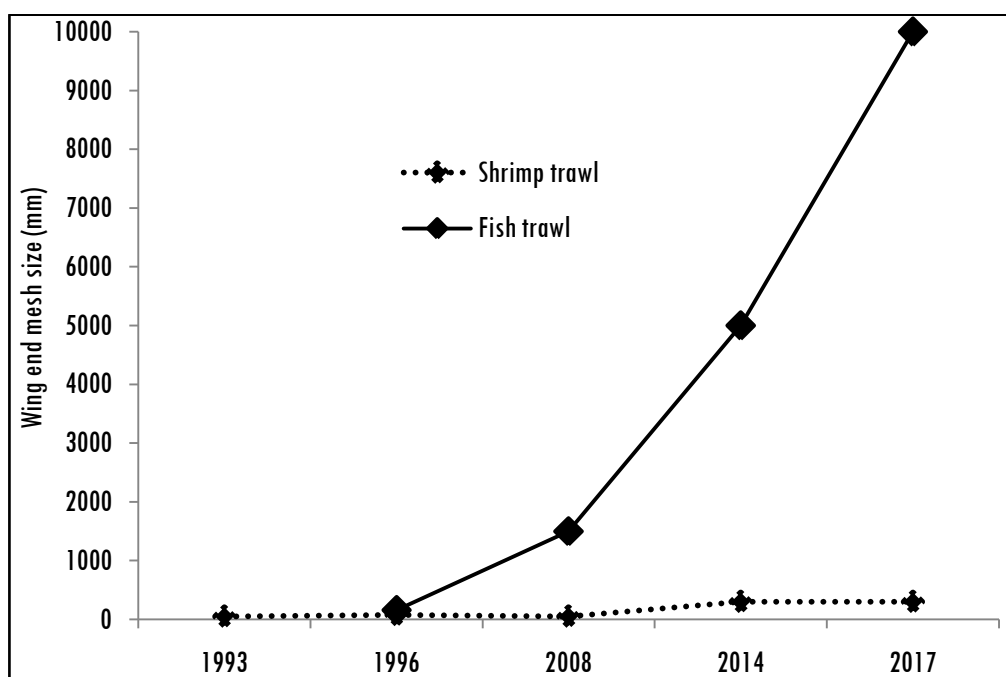

Fig.4.7 Growth in wing end mesh size of the trawl nets

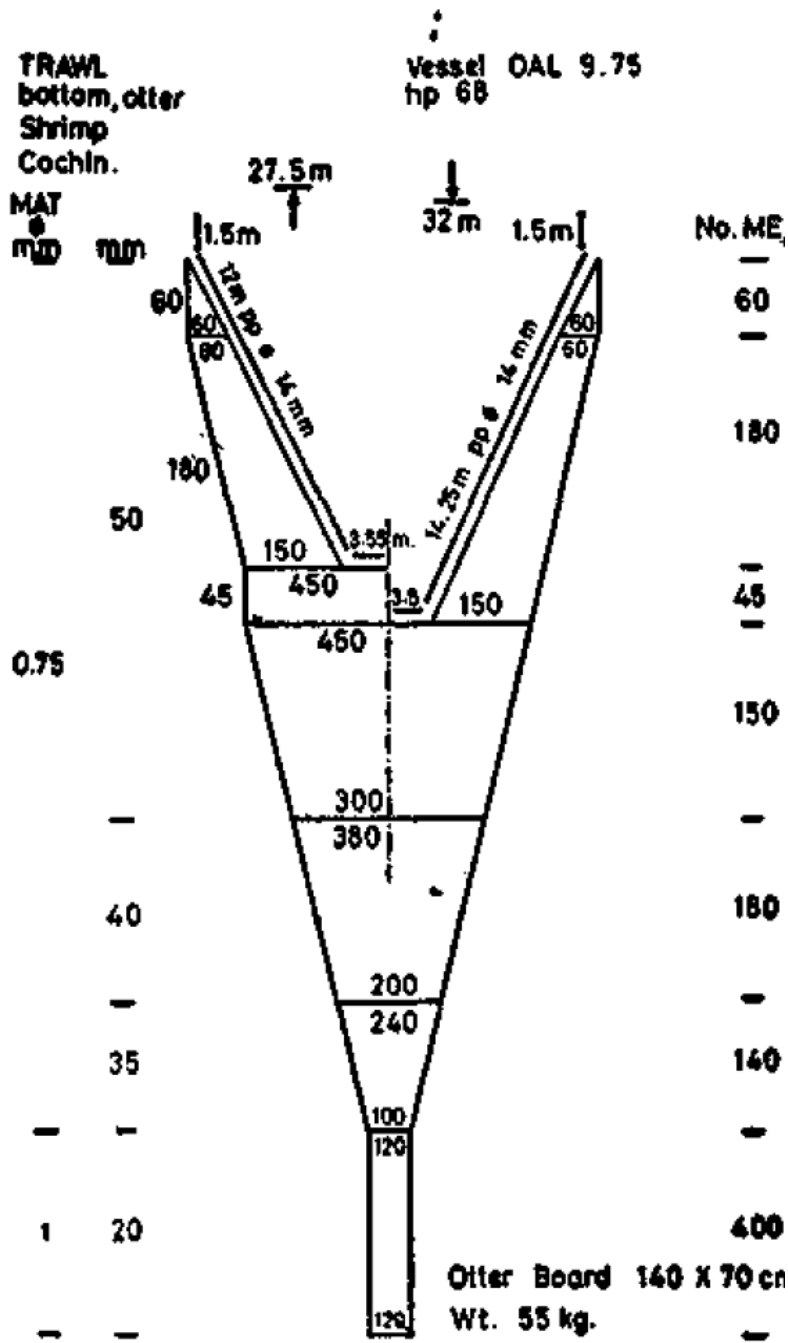

Fig.4.8 Design of trawl net from Cochin coast in 1993 (Source: Mukundan & Hameed, 1993)

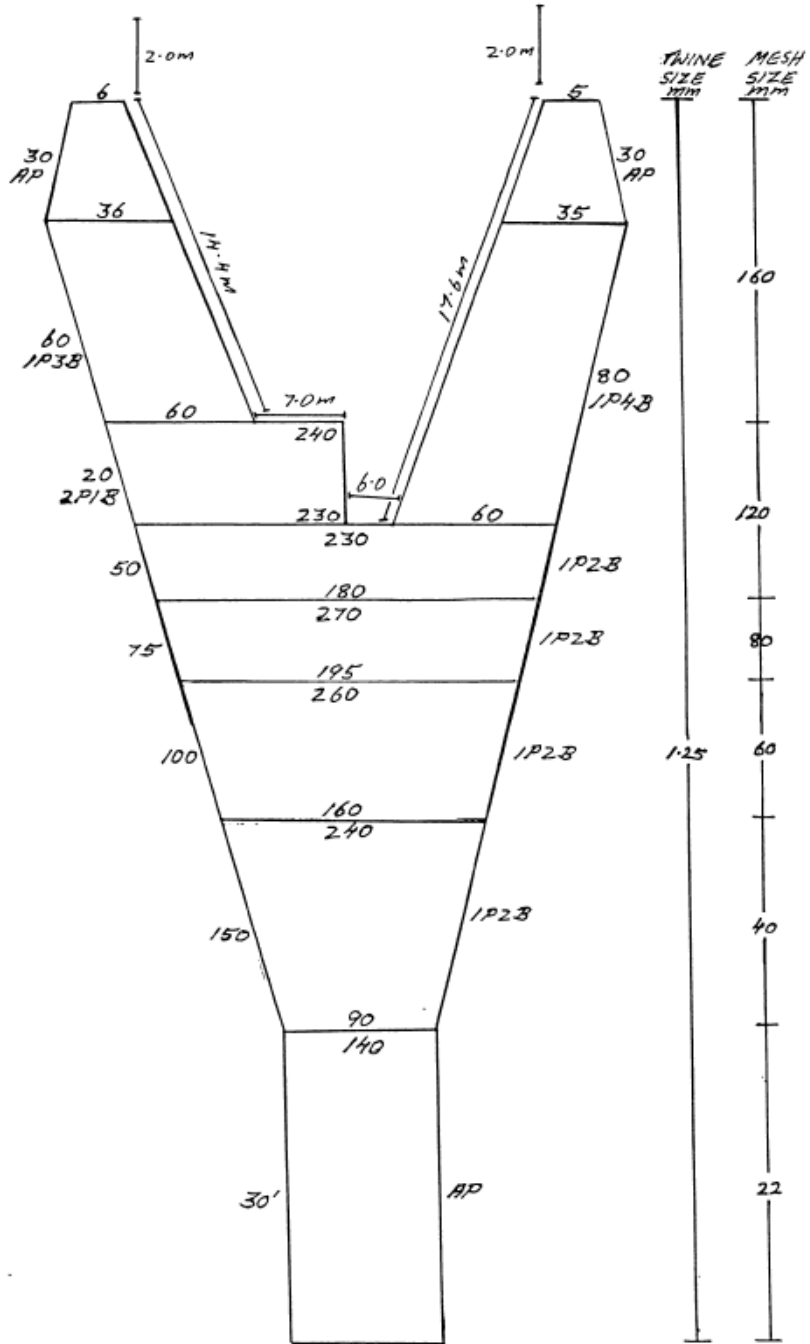

Fig.4.9 Design of fish trawl along Kerala coast during 1996 (Source: John, 1996)

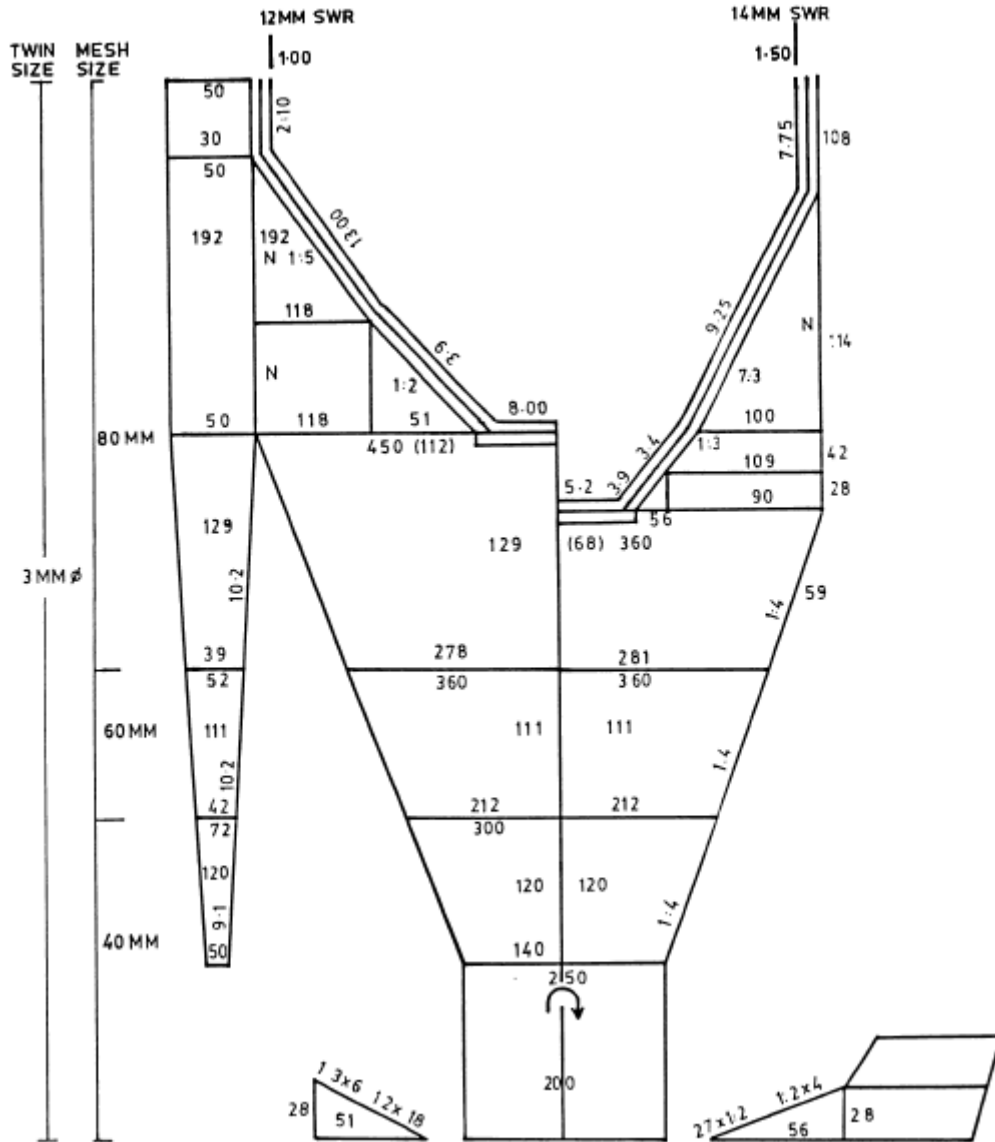

Fig.4.10 Design of shrimp trawl along Kerala coast during 1996
(Source: John, 1996)

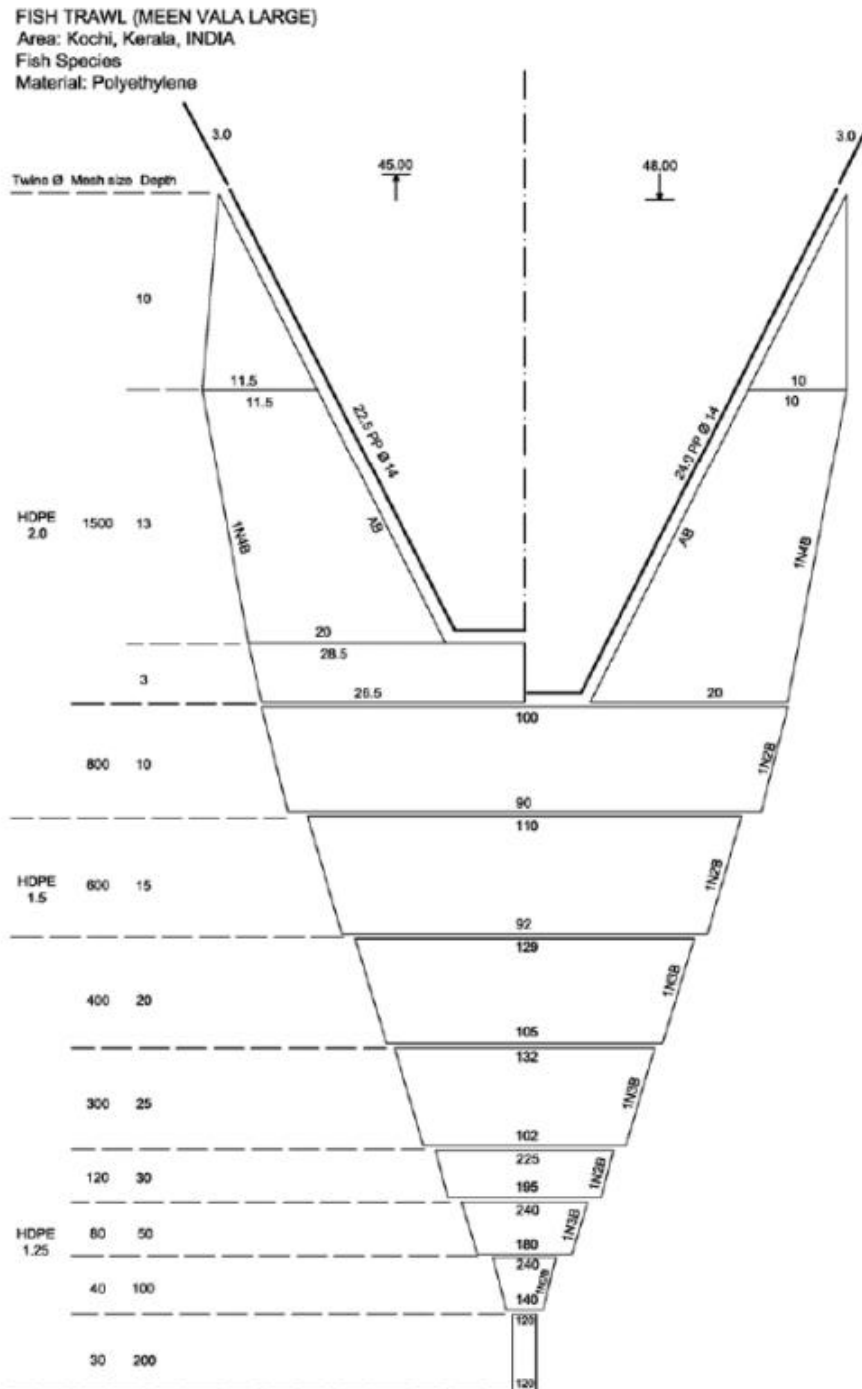

Fig.4.11 Design of fish trawl from Cochin during 2008 (Source: Gibinkumar, 2008)

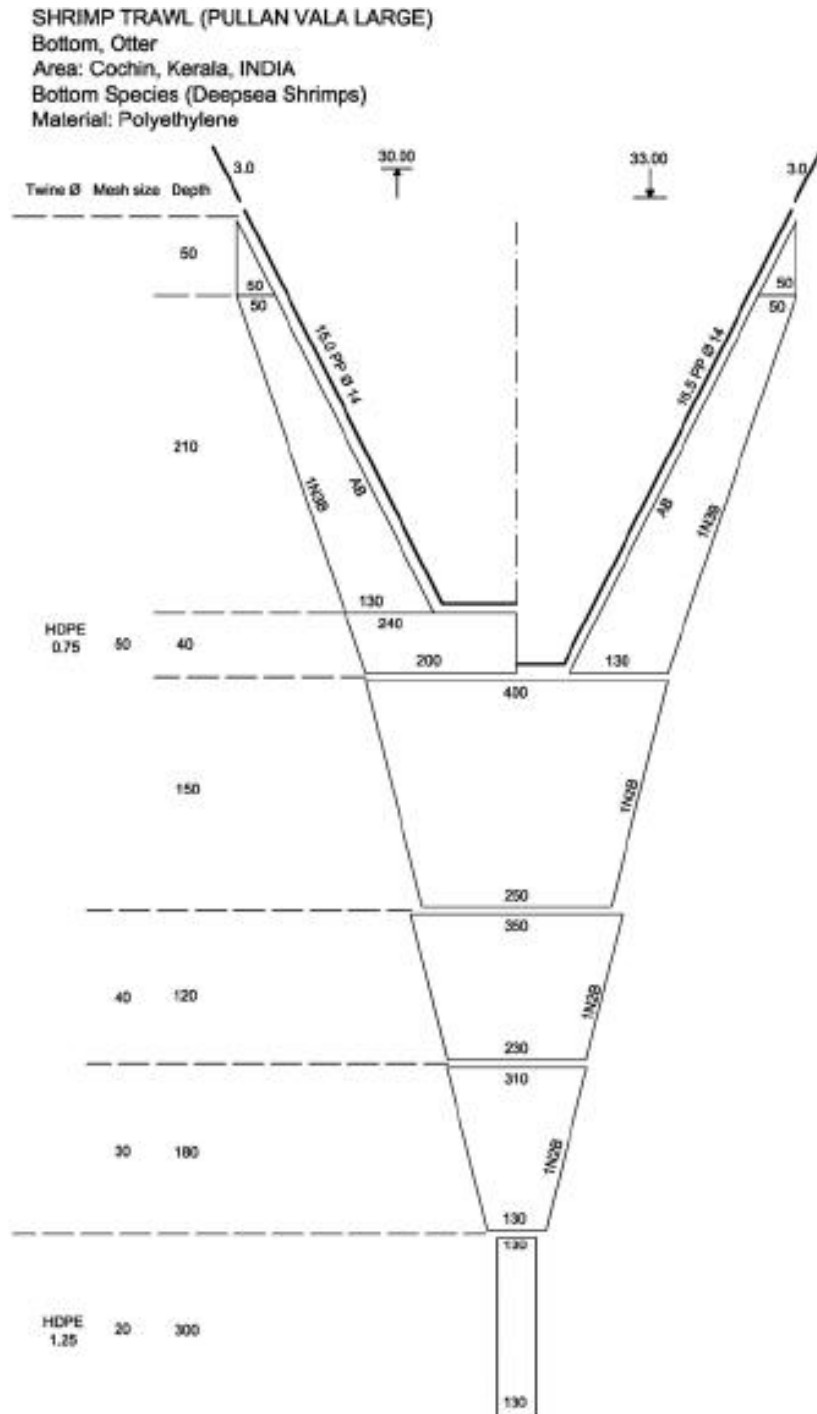

Fig.4.12 Design of shrimp trawl from Cochin during 2008 (Source: Gibinkumar, 2008)

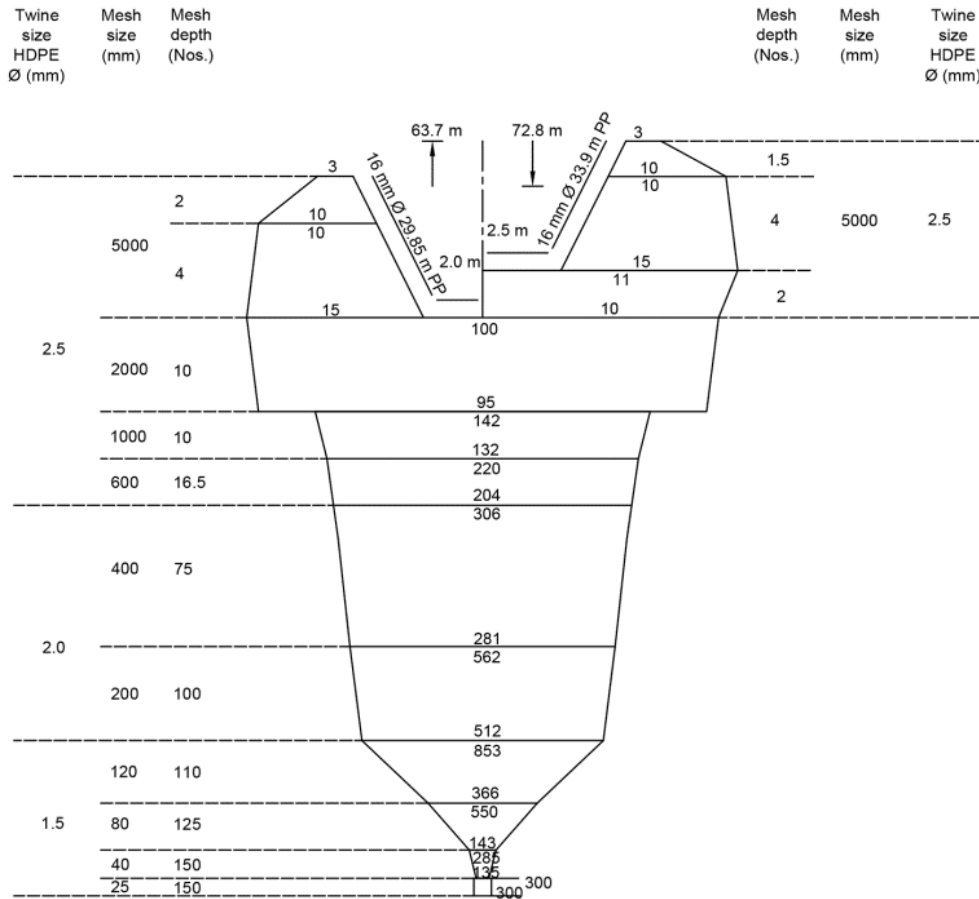

Fig.4.13 Design of fish trawl from Kozhikode, Kerala during 2014
 (Source: Edwin *et al.*, 2014a)

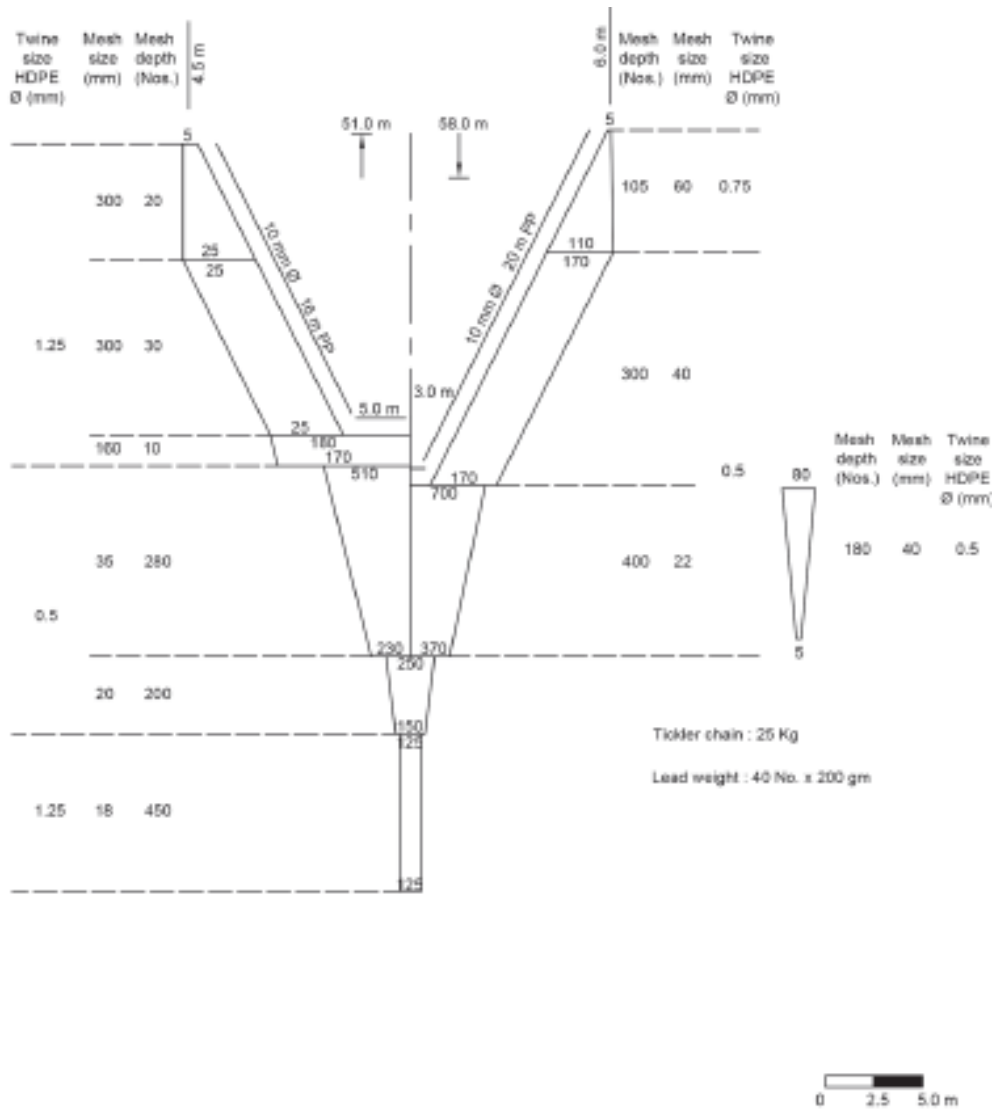

Fig.4.14 Design of shrimp trawl from Kozhikode, Kerala during 2014
(Source: Edwin *et al.*, 2014a)

4.3.4 Growth in trawling operation

Trawling started with single-day operations and currently trips exceeding 15 days are common as trawling in near shore waters are no longer remunerative. Beam trawls, the forerunner of otter trawls were there in operation which are removed completely as otter trawls became popular. Kurian (1953) and Scariah *et al.* (1999) reported the use of beam trawls in Kerala coast during initial phase of trawling introduction. Initiation of otter trawling along Kerala coast was commenced in Cochin in 1958, when several designs of shrimp trawls were introduced (Satyanarayana *et al.*, 1962 and Kurian *et al.*, 1964). Since introduction, otter trawls dominated in the sector and gradually beam trawls became completely removed and at present trawlers in the state exclusively use otter trawls. Flat rectangular type was the only otterboards used by trawlers regardless the size of trawlers and trawl nets during 1990s (John, 1996). 'V' form steel otterboard are more prevalent at present in the state except for small trawlers which was earlier reported by Edwin *et al.* (2014a).

First shrimp trawling was reported to carried out at a depth of 4-18 m (Kristjanson, 1967) then it extended to 50 m depth during late 90s (Jyothilal, 1998). Scariah *et al.* (1999) also reported the depth of operation by the trawlers in the state as 9 to 35 m. During 2000-2001 period maximum depth of operation by Kerala trawlers was 300 m targeting cephalopods and deep sea shrimps (Kurup & Radhika, 2007). Hassan & Sathiadhas (2009) reported 420 m as maximum depth of fishing ground for trawlers in the state. The growth in depth of fishing ground is depicted in Fig.4.15. As deep sea fishing became more popular, trawl ground has been extended to beyond 800 m (Edwin *et al.*, 2014a). Number of crew onboard also showed significant increase, which was 4 in 1996, 10 in 2008, 12 in 2014 and at present large trawlers accommodate up to 20 crew. During early stages the operation was completely manual, but

currently releasing of warp and hauling the net is mostly mechanical with the help of winches and pulleys.

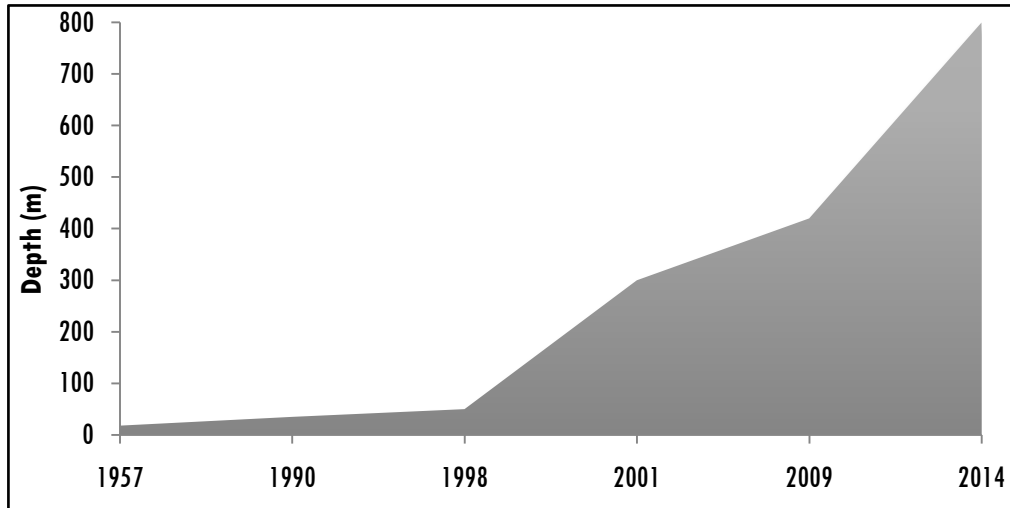

Fig.4.15 Growth in depth of operation of trawlers

Regarding catch and yield of trawlers, a decline in catch has been reported since 1970 till 1988 (Scariah *et al.*, 1999). Catch of trawlers were one lakh tones during 1975-79 period which had been lowered to 0.49 lakhs during 1980-84 period, but the implementation of seasonal trawl ban made benefits in the sector and catch has been increased since 1988 (Nair, 1989). Till 2001 trawl landings showed increasing trend except in 1995. During this period, highest landing from trawlers was recorded in 1997; it is 3.17 lakh tones (Scariah *et al.*, 1999). At present trawlers contributed 57% of the Kerala marine fish production which is 2.4 lakh tones.

4.3.5 Conclusion

Trawling, one of the most prominent fishing technique in mechanised marine fishery of Kerala, has changed a lot since its introduction which resulted in excess capacity and overfishing. An assessment of these changes will be

helpful to management of fishing fleets in Kerala. The results of the chapter delineated that trawl fishery of Kerala demonstrated large scale changes since introduction. The changes are evident in trawlers, trawl nets and operation. Number of trawlers have increased five times, size of trawlers showed five times growth, engine power grown 55 times, head rope length of trawl nets have grown 15 times and wing end mesh size also showed significant growth. Wing end mesh size of shrimp trawls increased six times and that of fish trawls has grown over 60 times. Among the changes occurred growth in wing end mesh size of trawl nets have a positive impact which can be attributed to decreased fuel consumption and rest all are leading to an unsustainable fishery and excess capacity. Significant shifting of fishing ground is also evident which is a result of increased fishing pressure in the coastal waters. Storage capacity of trawlers, no. of crew, duration of fishing, no. of trawl nets carried onboard also showed momentous growth. Hence for a sustainable and balanced fishery, care should be taken to prevent further growth.



FUEL CONSUMPTION, ENERGY EFFICIENCY AND ENVIRONMENTAL BURDENS OF MECHANISED TRAWLERS IN KERALA

5.1 Introduction

In fisheries sector exists two extremes one is artisanal fishery consuming no fuel or least fuel (for propulsion) and the other is mechanised sector where all the activities are facilitated with the help of energy. Mechanised fishing is an energy intensive method of food production which consumes 15-20 times more energy than it produces (Endal, 1989). It is exclusively depending on fossil fuel which is limited and non-renewable. Most of the environmental concerns mankind faces can be connected to energy use especially fossil fuels in one way or other. Fossil fuel release carbon dioxide and other green house gases to the atmosphere which leads to the phenomenon, ‘green house gas effect’ and its concomitant impacts make changes in climate, sea level rise and global warming. Fossil fuels are also responsible for production of pollutants such as suspended particulate matter, photochemical smog particulates, ozone-depleting substances like CFCs and gaseous emissions such as sulphur dioxide (SO₂), carbon monoxide (CO) and oxides of nitrogen, which are injurious to the environment and human health (TERI, 1999; Pelletier *et al.*, 2007; Avadi & Freon, 2013 and Parker &

Tyedmers, 2015). Because of all the specified concerns fuel use can be the key to determine the environmental sustainability of a fishery activity.

While authorities and stakeholders are long have been concerned with the cost of fuel input in food production, demand for low carbon food products is increasing. Hence fisheries policy making and management processes is overlooking at these issues considerably. Carbon emission from fisheries is based on two aspects primarily as a waste of fossil fuel combustion and secondarily as provision of craft, gear, engine, fuel, ice and other necessities (Ziegler *et al.*, 2003; Hospido & Tyedmers, 2005 and Thrane, 2006).

Fuel consumption is a factor which heavily depend on various factors among which type of fishing method employed is predominant (Boopendranath, 2008; Thrane, 2004b; Tyedmers *et al.*, 2005; FAO, 2007; Schau *et al.*, 2009; Winther *et al.*, 2009; Cheilari *et al.*, 2013; Parker & Tyedmers, 2015; Parker *et al.*, 2015; Wiviott & Mathews, 1975; Leach, 1976; Edwardson, 1976; Lorentzen, 1978; Rawitscher, 1978; Nomura, 1980; Hopper, 1982; Watanabe & Okubo, 1989 and Tyedmers, 2001). Purse seining and trawling are the most common fishing methods (Sainsbury, 1971) among which trawling found to be 15 times more energy intensive than purse seining. Not only in comparison with purse seining, trawling found to be more energy intensive when compared to any other fishing methods whether it is active or passive (Wiviott & Mathews, 1975; Leach, 1976; Edwardson, 1976; Lorentzen, 1978; Rawitscher, 1978; Nomura, 1980; Hopper, 1982; Watanabe & Okubo, 1989 and Tyedmers, 2001). In the view of growing fuel price, studies on fuel use in fisheries especially trawling have been estimated and assessed by several experts in several regions (Boopendranath, 2000; Tyedmers 2001; Thrane, 2004b; Sterling & Goldsworthy, 2007; Sumaila *et al.*, 2008; Winther *et al.*, 2009; Abernethy *et al.*, 2010; Driscoll & Tyedmers,

2010; Vázquez-Rowe *et al.*, 2011; Suuronen *et al.*, 2012; Tyedmers & Parker 2012). In addition to the type of fishing method employed, amount of fuel consumption may vary depending on the size and design of the vessel, weather conditions, type and size of fishing gears, location, skill and knowledge of the crew (Sala *et al.*, 2012) among which vessel size have a major role (Wiviott & Mathews, 1975; Rochereau, 1976; Edwardson, 1976; Lorentzen, 1978; Watanabe & Okubo, 1989).

Fuel use intensity otherwise known as fuel efficiency in fish capturing is the most common aspect studied regarding energy use compared to an overall quantification of fuel use. Tyedmers *et al.* (2005) estimated the amount of fuel burnt by global fishing fleet as 50 billion litres of diesel per year. Annual fuel consumption by the mechanised and motorised fishing fleet of India during 2000 has been estimated at 1220 million litres which formed about 1% of the total fossil fuel consumption (Boopendranath, 2008). Vivekanandan *et al.* (2013) has estimated the diesel consumption by the mechanized and motorised fishing vessels in India as 1378.8 million litres in 2010 releasing about 3.13 million tonnes of CO₂ to the atmosphere at an average rate of 1.02 tonnes per tonne of live-weight of marine fish landed. Ravi (2015) has estimated the total fuel use by the mechanised trawling sector of Kerala during 2012-13 as 106.3 million litres at a rate of 0.41 kg per kg of fish landed.

Dominance of fuel in trawl fishery in making hazards to the environment in the form of carbon emission is a proven fact and a concern among environmentalists (Ravi, 2015; Boopendranath, 2000, 2008 & 2012; Ziegler & Valentinsson, 2008; Ziegler *et al.*, 2009; Vázquez-Rowe *et al.*, 2010; Vázquez-Rowe *et al.*, 2012 and Vivekanandan *et al.*, 2013). LCA studies conducted in trawlers shows the dominance of fuel used in trawling

operation in carbon emission compared to the emission from the vessel and gear (Ziegler *et al.*, 2003; Hospido & Tyedmers, 2005; Ziegler & Valentissson, 2008; Vázquez-Rowe *et al.*, 2010; Ravi, 2015; Vázquez-Rowe *et al.*, 2012, Vivekanandan *et al.*, 2013; Ghosh *et al.*, 2014; Edwin & Hridayanathan, 1997; Boopendranath, 2000, 2008, 2012; Ziegler *et al.*, 2003; Thrane, 2004a,b; Hospido & Tyedmers, 2005; Ziegler *et al.*, 2009 and Vázquez-Rowe *et al.*, 2014).

Fuel use and its intensity of a given fishery even within a local area can change as the abundance of fisheries resources change, fleets expand, average size of vessels increase, vessels travel further to fish and become more technologically advanced. Rising fuel price in association with the future scarcity of fossil fuels and increased environmental hazards have raised the awareness on fuel efficiency of fishery sector. As the demand for less carbon footprint product is increasing, authorities and stakeholders overlook fuel use profiles and its resultant environmental burdens in fisheries. All these factors necessitate studies on energy input, its intensity and dimensions of burdens caused. On these background an assessment of fuel use in Kerala trawl fishery and its variations, fuel use intensity and resultant carbon emission are depicted in the chapter.

5.2 Materials and methods

The study was conducted among 40 selected trawlers operated from Munambam and Cochin harbours of Ernakulam district of Kerala. Data regarding fuel consumption and catch of each trip of selected trawlers were collected for continuous two years from June, 2014 to May, 2016. Data on fuel consumption was collected using pretested questionnaire, which administered to the engine driver of the trawlers and were collected back after their arrival.

Questionnaire used for the study has been given as Annexure III and sampling and data collection are explained in section 2.2.2. Annual fuel consumption of trawlers has estimated as the sum of fuel consumption per trip for whole year and the average of two years is considered.

Fuel use intensity is calculated in the form of litres of fuel used per tonne of fish landed and kg of fuel used per kg of fish landed. Energy intensity is calculated by the formula, $I = Q/L$ where, I is the energy intensity, Q is the energy equivalent to quantity of fuel consumed in MJ and L is the quantity of landings in tonnes (Tyedmers, 2001 & Cheilari *et al.*, 2013). Fuel related carbon emission was calculated using the assumption, 2.7 kg of CO₂ is released per litre of diesel consumed (USEPA, 2014).

5.3 Results and discussion

The chapter focuses on the fuel consumption of mechanised trawlers in Kerala. As there is a wide range of trawlers based on their size and duration of operation, fuel consumption varies considerably. Hence fuel consumption per vessel has been estimated separately for different length class of trawlers. In Kerala, both single-day and multi-day trawlers exist in which single-day trawlers constitute only 5% of the total trawl fishing fleet and remaining 95% are multi-day trawlers with a maximum duration of 15 days. Fuel consumption in terms of fuel consumption per trip, fuel consumption per day, fuel consumption per hour and annual fuel consumption in litres of five types of trawlers were estimated. Number of fishing days and fishing trips in a year, average duration of fishing trips, energy efficiency and carbon emission pattern of mechanised trawlers are also estimated.

5.3.1 Fuel consumption in mechanised trawlers

5.3.1.1 Single-day trawlers

In Kerala only small trawlers are conducting single-day fishing at present. They have an L_{OA} of 10-12 m and are powered with engines of 116 to 240 hp. They use exclusively shrimp trawls throughout the year which are smaller in size when compared to fish trawls and cephalopod trawls. Their operation is restricted to seven months from November to May during peak fishing season. Number of fishing days in a year varied from 178 to 214 with an estimated average of 200 days in a year (Fig.5.1). During the year 2005, single day mechanised trawlers were reported to conduct fishing for 180 days in a year (Unnithan *et al.*, 2005). Aswathy *et al.* (2011) reported 180 to 200 fishing days in a year for single-day trawlers having L_{OA} 8.5 to 9.5 m with an average duration of 6-8 hours. In the present study average duration of operation by single-day trawlers were estimated to be 8 hours (Table 5.1). Annual fuel consumption of trawlers is estimated as sum of the fuel consumption of all trips in a year from November to May. The average annual fuel consumption of small trawlers (single-day) is estimated to be 12036 litres per vessel with a range of 11760 to 12312 litres. During the study period, fuel consumption per day varied from 49 to 70 litres and the average is estimated as 60 litres (Fig.5.2). Ravi (2015) also reported the same. Average duration of operation in a day was 8 hours and hence average fuel consumption per hour can be calculated as 7.5 litres with a range of 6.12 to 8.75 litres. Profile of fuel consumption of single-day trawlers is included in Table 5.2.

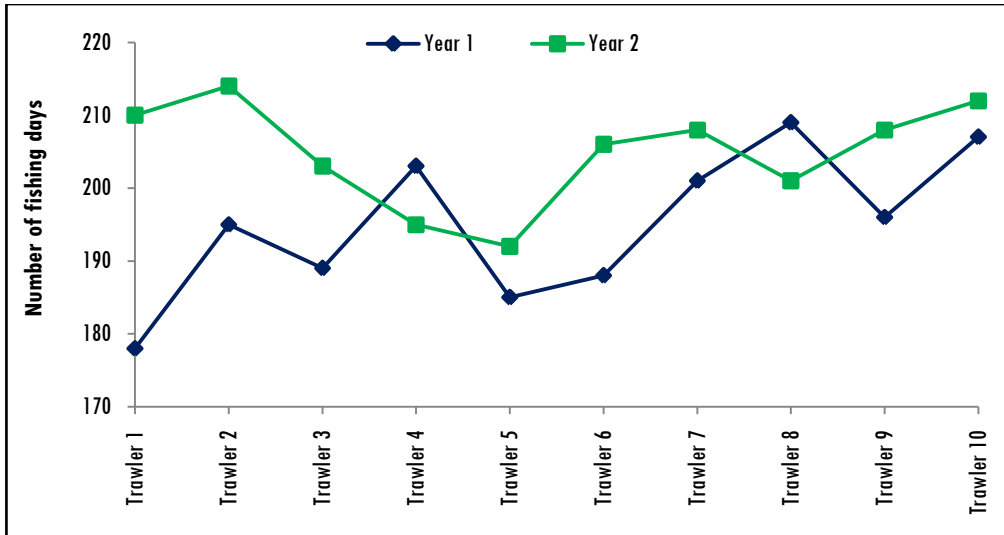

Fig.5.1 Average number of fishing days in a year for selected single-day trawlers during study period

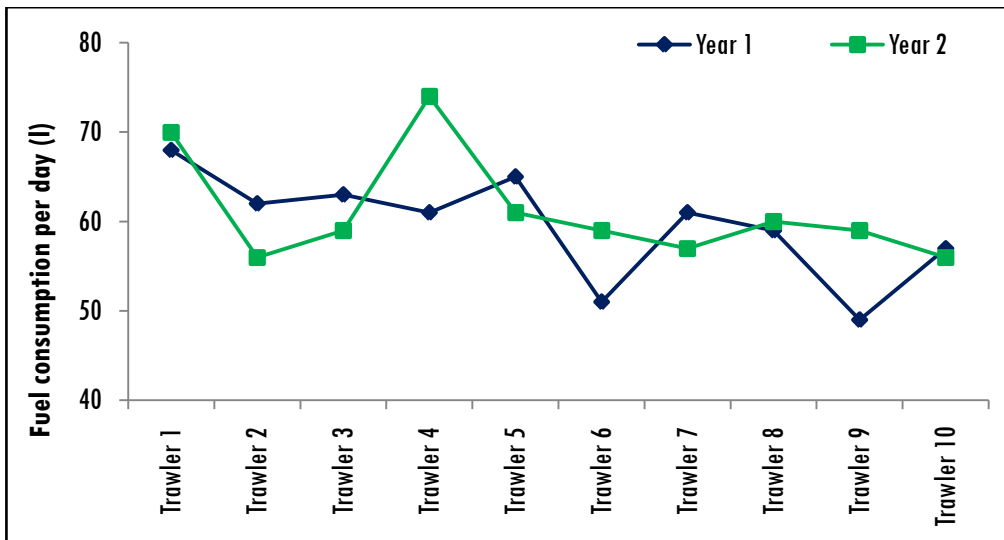

Fig.5.2 Average fuel consumption per day of selected single-day trawlers during study period

5.3.1.2 Multi-day trawlers

Multi-day trawlers operate whole year except trawl ban period, hence it can be said that on an average they conduct fishing for 10 months in a year. These trawlers target finfish, shrimps and cephalopods depending on the season and availability of resources. There are three fishing seasons for trawlers in the state; one is from August to October targeting shrimps, second from November to March when fishing is without any specific target and third from April to June targeting fish.

5.3.1.2.1 Small trawlers

Small trawlers constructed with steel and powered with 240-350 hp imported engines conduct multi-day operations. Number of fishing days of small trawlers (multi-day) varied from 196 to 245 days in a year (Fig.5.3) and the average number of fishing days is estimated to be 200. Ravi (2015) estimated 240 fishing days in a year for small trawlers. Fuel consumption per trip of small trawlers (multi-day) varied from 414.0 to 510.0 litres (Fig.5.4) and on an average it can be estimated as 468.0 litres. Number of trips in a year by these category of trawlers varied from 67 to 81 and on an average conduct 75 trips in a year (Table 5.1). Duration of trip varied from three to four days and the average duration is estimated as 3 days. Annual fuel consumption of small trawlers (multi-day) ranged from 34095 to 36085 litres with an average of 35090 litres per vessel (Table 5.2). Fuel consumption per day varied from 138 to 170 litres and the average is estimated to be 156.0 litres. Average duration of operations in a day was 9 hours for this category of trawlers and hence average fuel consumption per hour is estimated as 17.3 litres with a range of 15.3 to 18.9 litres. A profile of fuel consumption of small trawlers (multi-day) is included in Table 5.2. .

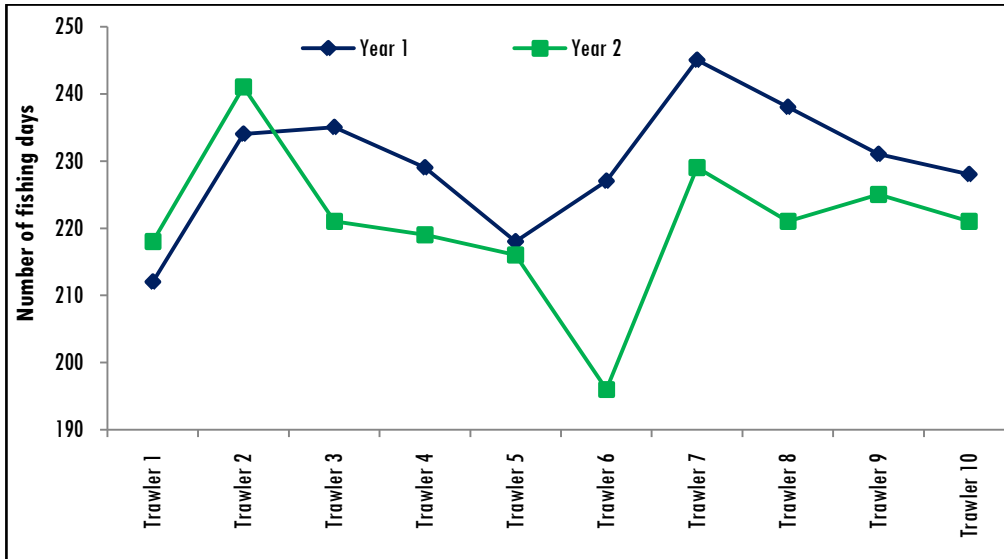

Fig.5.3 Average number of fishing days in a year of small trawlers (multi-day) during the study period

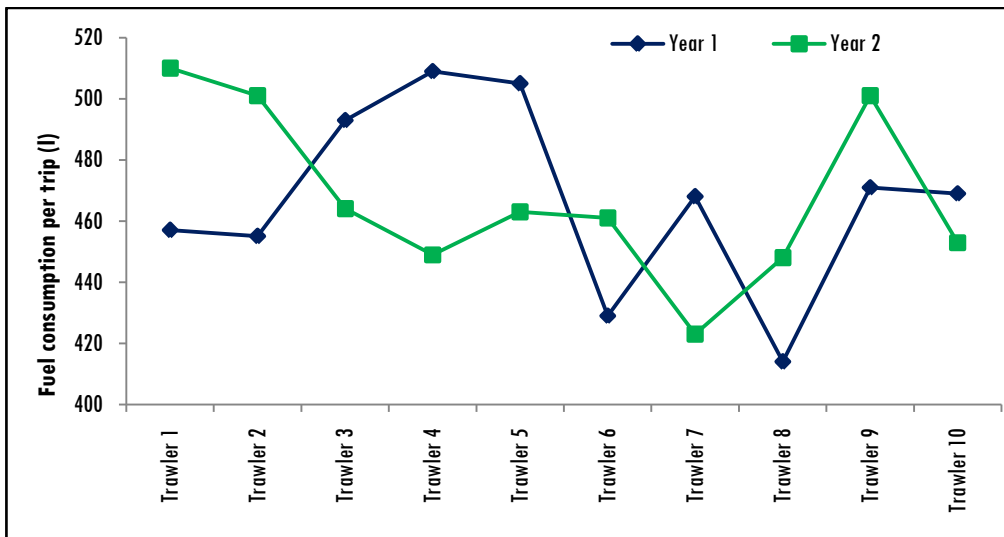

Fig.5.4 Average fuel consumption per trip of small trawlers (multi-day) during study period

5.3.1.2.2 Medium trawlers

Medium trawlers are found to conduct only multi-day fishing extending from 3 to 10 days (Table 5.1). Average duration of fishing trip of these trawlers can be estimated as 5 days. Number of fishing trips in a year for these category of trawlers ranged from 41 to 53 and the average was 49 trips (Table 5.1). The number of fishing days in a year varied from 227 to 261 and the average annual fishing days of these trawlers is estimated to be 243 days (Fig.5.5 & Table 5.1). Engine power of medium sized mechanised trawlers of Kerala during 2005 was reported as 100 hp and the number of fishing trips in a year was 80 trips, but the trip duration was only 3-8 days (Unnithan *et al.*, 2005). In the present study, fuel consumption per tip of medium trawlers varied from 949.0 – 1220.0 litres (Table 5.2 & Fig.5.6) and average fuel consumption per trip is estimated to be 1125.0 litres. Fuel consumption per day varied from 190.0 to 244.0 litres in these trawlers and the average was estimated at 225.0 litres. Average duration of operations in a day was 11 hours for medium trawlers and hence fuel consumption per hour is estimated as 20.45 litres with a range of 17.25 to 22.17 litres. Ravi (2015) has reported the fuel consumption of medium trawlers as 192 to 540 litres in a day. During 2007, fuel consumption per day of trawlers with L_{OA} less than 16.0 m was reported as 100 to 200 litres which came upto 500 to 1000 litres per trip depending on the duration of the trip (Aswathy *et al.*, 2011). Average annual fuel consumption of medium trawlers in the state at present is 54722 litres per vessel which ranged from 46287 to 60243 litres.

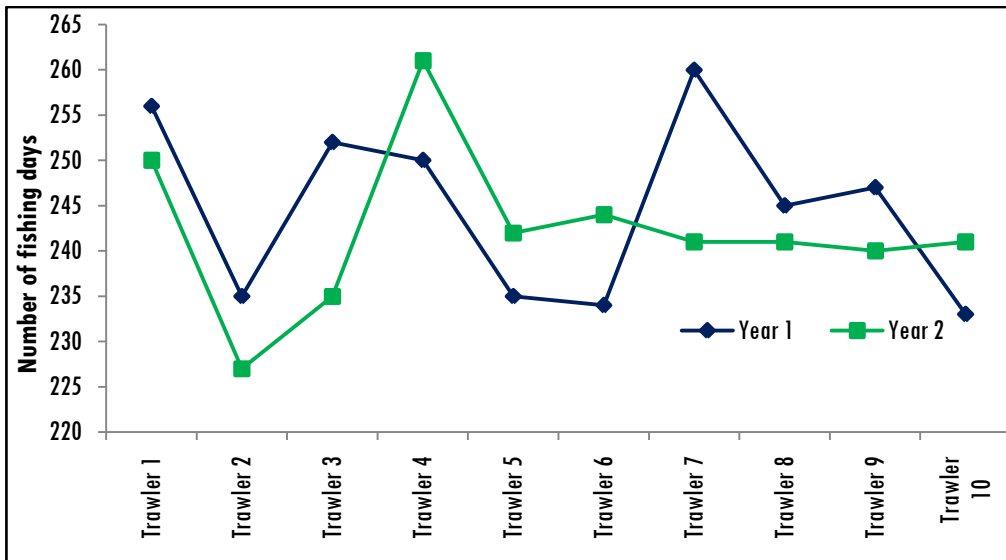

Fig.5.5 Number of fishing days in a year of medium trawlers during study period

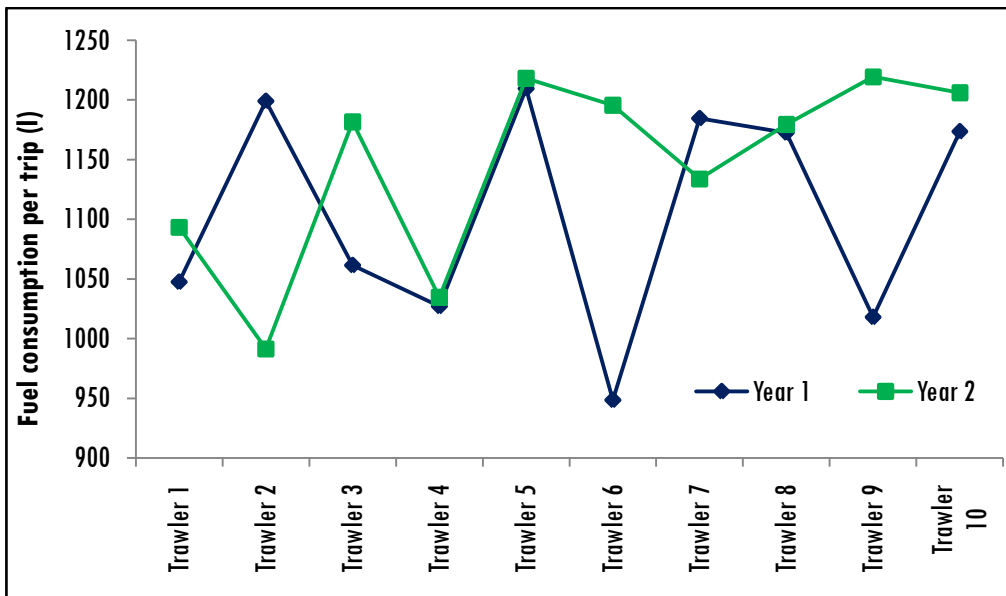

Fig.5.6 Fuel consumption per trip of medium trawlers during study period

5.3.1.2.3 Large trawlers

Large trawlers have L_{OA} between 16.0 and 24.0 m exclusively powered with imported engines of 350 to 495 hp. They conduct multi-day fishing for whole year and number of fishing days varied from 239 to 272 days in a year (Fig.5.7). On an average large trawlers are estimated to have 250 fishing days in a year (Table 5.1). Fuel consumption per trip of these trawlers varied from 3207 to 3877 litres and the average fuel consumption per trip can be estimated as 3610 litres (Fig.5.8). On an average they conduct 25 trips in a year with an average duration of 10 days per trip. Annual fuel consumption of these trawlers ranged from 86438 to 97675 litres. On an average annual fuel consumption of large trawlers is estimated to be 90285 litres per vessel. Average fuel consumption per day can be estimated as 361.07 litres with a range of 320.66 to 387.73 litres (Table 5.2). Average duration of fishing in a day was 12 hours for this category of trawlers. Hence average fuel consumption per hour of large trawlers is estimated as 30 litres which ranged from 26.7 to 32.3 litres. Profile of fuel consumption of large trawlers is given in table 5.2. Large mechanised trawlers having L_{OA} more than 16.0 m are reported to have fishing trip duration from 6 to 12 days and were conducting 30 to 40 fishing trips in a year during 2007 and they consumed 250 – 300 litre of fuel per day and 1000 – 2000 litre of fuel per trip (Aswathy *et al.*, 2011).. Large trawlers are reported to have engine power of 126 hp during 2005 and they conducted 40 fishing trips in a year with a duration of 5-7 days (Unnithan *et al.*, 2005).

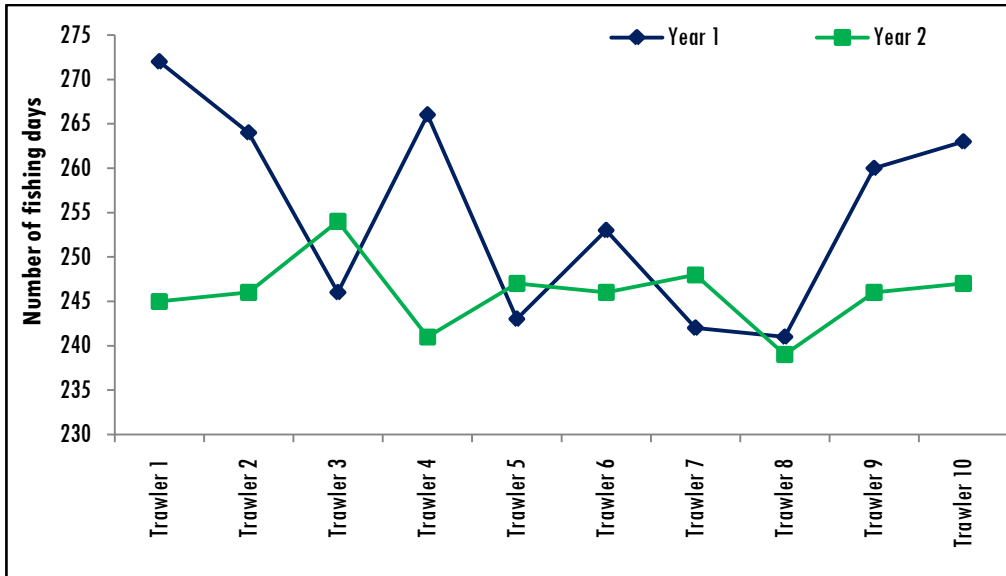

Fig. 5.7 Number of fishing days in a year of large trawlers during study period

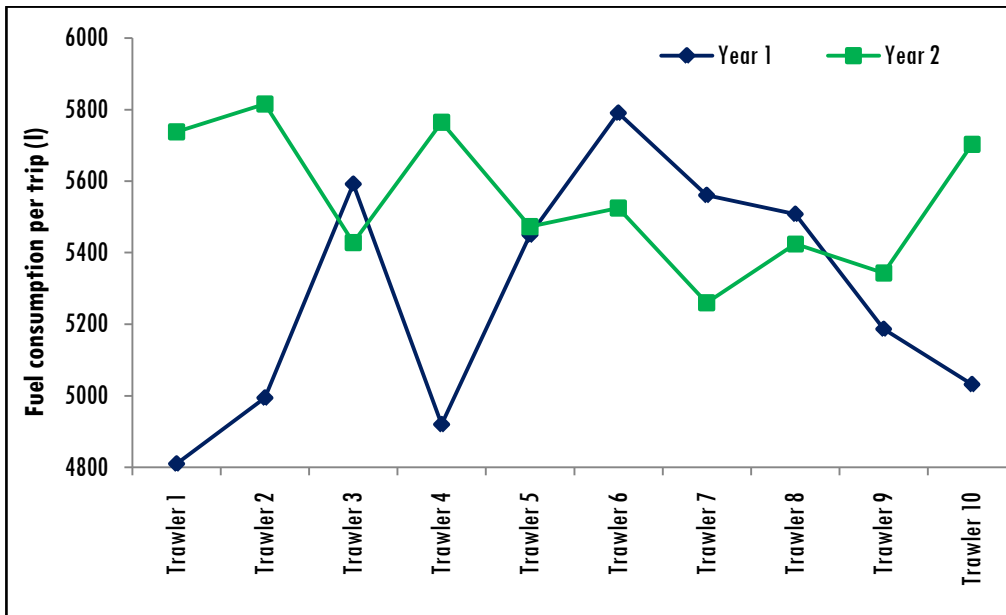

Fig.5.8 Fuel consumption per trip of large trawlers during study period

5.3.1.2.4 Very large trawlers

Trawlers with L_{OA} more than 24.0 m, very large trawlers are powered with exclusively imported engines of power 427 to 550 hp. They conduct absolutely multi-day fishing extending from 10 to 15 days. Average duration of fishing trip for very large trawlers is estimated as 12 days. Fuel consumption varied from 6735 to 7345 litres per trip with an average of 6987 litres per vessel (Fig.5.10). Annual fuel consumption of these trawlers varied from 140589 to 153246 litres and the average is estimated as 146732 litres in a year. Ravi (2015) has also quantified the annual fuel consumption of very large trawlers between 103680 and 151200 litres. Total number of fishing days varied from 235 to 273 days a year (Fig.5.9) and the average can be computed as 252 days. Unnithan *et al.* (2005) has estimated the annual fishing days of large mechanised vessels in Kerala as 280 days but highest annual fishing days observed during present study is 273 days. Fuel consumption per day of these category of trawlers varied from 526.37 to 633.62 litres at present and the average is estimated to be 582.27 litres. Average duration of operation in a day for very large trawlers is estimated to be 12 hours and hence average fuel consumption per hour is calculated as 48.5 litres which ranged from 43.86 to 52.8 litres (Table 5.2).

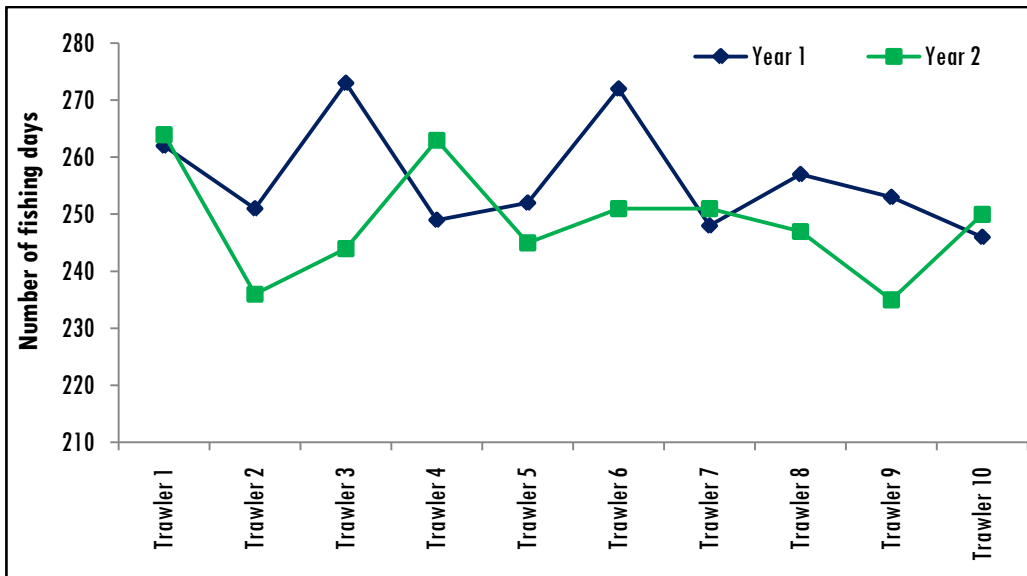

Fig.5.9 Number of fishing days of very large trawlers during study period

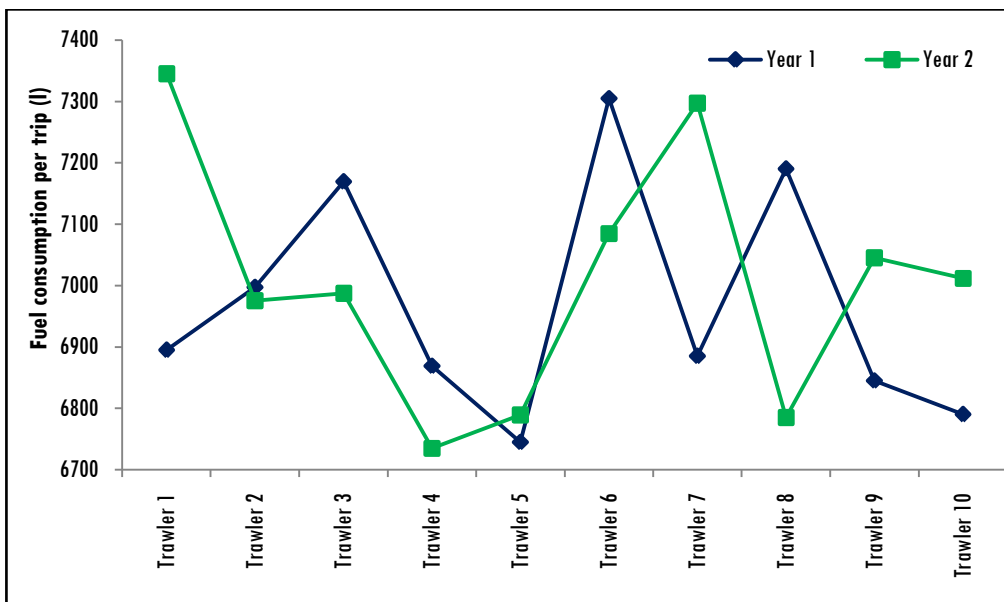

Fig.5.10 Fuel consumption per trip of very large trawlers during study period

According to the present study, both single-day and multi-day trawlers are operated in Kerala; single-day trawlers constitute only 5% and remaining 95% are multiday trawlers. A comparison of fuel consumption of different

length class of trawlers and duration of operation are depicted. Fishing time or duration of fishing is expressed in terms of number of fishing days in a year, number of fishing trips in a year, duration of trip in days and duration of fishing in a day. There is a significant distinction in fishing time among different length class of trawlers except large and very large trawlers. Duration of fishing in a day for small trawlers (single-day) is 8 hours, for small trawlers (multi-day) is 9 hours, for medium trawlers is 11 hours and for large and very large trawlers is 12 hours (Table 5.1). Average number of days in a trip also varied, it is 3 days for small trawlers, 5 days for medium trawlers, 10 days for large trawlers and 12 days for very large trawlers (Table 5.1). Average number of trips conducted by mechanised trawlers in Kerala in a year is; 75 trips for small trawlers, 49 for medium trawlers, 25 for large trawlers and 21 for very large trawlers (Table 5.1). At present average number of fishing days in a year for mechanised trawlers in the state is 200 days for small trawlers (single-day), 225 days for small trawlers (multi-day), 243 day for medium trawlers, 250 for large trawlers and 252 for very large trawlers (Table 5.1).

Table 5.1 A profile of fishing time of mechanised trawlers in Kerala

Type of trawlers	Average duration of fishing in a day	Average number of days in a trip	Average number of trips in a year	Average fishing days in a year
Small trawlers (Single-day)	8 hours	1	200	200
Small trawlers (multi-day)	9 hours	3	75	225
Medium trawlers	11 hours	5	49	243
Large trawlers	12 hours	10	25	250
Very large trawlers	12 hours	12	21	252

Rate of fuel consumption found to be varying according to the size of trawlers, engine power and duration of fishing. Through the present study it is understood that rate of fuel consumption is highest in very large trawlers followed by large trawlers, medium trawlers, small trawlers (multi-day) and small trawlers (single-day) (Table 5.2). A general comparison of fuel consumption between trawlers is not relevant because of the variation in factors influencing fuel consumption. Hence fuel consumption per day and fuel consumption per hour are used to compare the fuel consumption between trawlers. To understand the difference in fuel consumption between single-day and multi-day operations, a comparison of small trawlers (single-day) and small trawlers (multi-day) is depicted. Fuel consumption per day of single-day trawlers is 60 litres and that of multi-day trawlers is 156 litres, accordingly single-day operations consume 62% less fuel than multi-day operations (Table 5.2 & Fig.5.11). But there is a significant variation in duration of operation in a day, it is 8 hours for single-day trawlers and 9 hours for multi-day trawlers. Hence a comparison of fuel consumption per hour will be more accurate. The average fuel consumption per hour of single-day trawlers is 7.5 litres and that of multi-day trawlers is 17.3 litre (Table 5.2 & Fig.5.12). Hence it can be concluded that single-day trawlers consume 57% less fuel compared to multiday trawlers. Major reason behind this variation is the make of engine and its power used by the trawlers. The horsepower of engine used by single-day trawlers ranged from 116- 240 hp but for multiday trawlers it is 240-350 hp.

Table 5.2 Profile of fuel consumption (litres) of mechanised trawlers in Kerala (Average is shown in parenthesis)

Specification	Small trawlers (single-day)	Small trawlers (multi-day)	Medium trawlers	Large trawlers	Very large trawlers
Fuel consumption per hour	6.12 - 8.75 (7.5)	15.3 - 18.9 (17.3)	17 - 23 (20.45)	26.7 - 32.3 (30.1)	43.86 - 52.8 (48.5)
Fuel consumption per day	49 - 70 (60)	138 - 170 (155.7165)	190 - 244 (225.0)	320.66-387.73 (361.07)	526.37 - 633.62 (582.27)
Fuel consumption per trip	-	414 - 510 (467)	948.5 - 1219.5 (1125)	3207 - 3877 (3610)	6735 - 7345 (6987)
Fuel consumption per year	11760 - 12312 (12036)	34095 - 36085 (35090.3)	46287 - 60243 (54722.0)	86438 - 97675 (90285)	140589 - 153246 (146732.5)

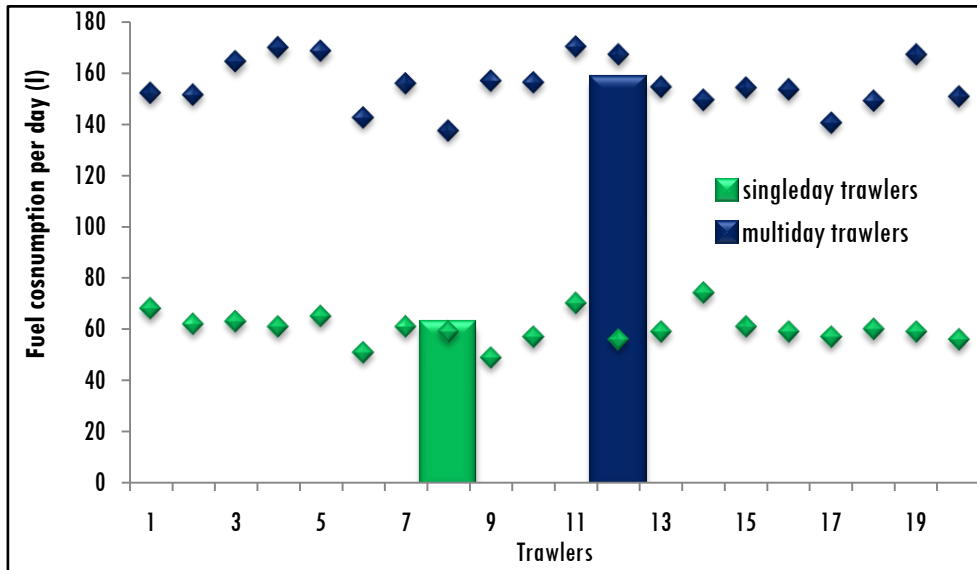

Fig.5.11 Comparison of fuel consumption per day of single-day and multi-day trawlers (small trawlers) of Kerala [Bar graph shows the average fuel consumption per hour]

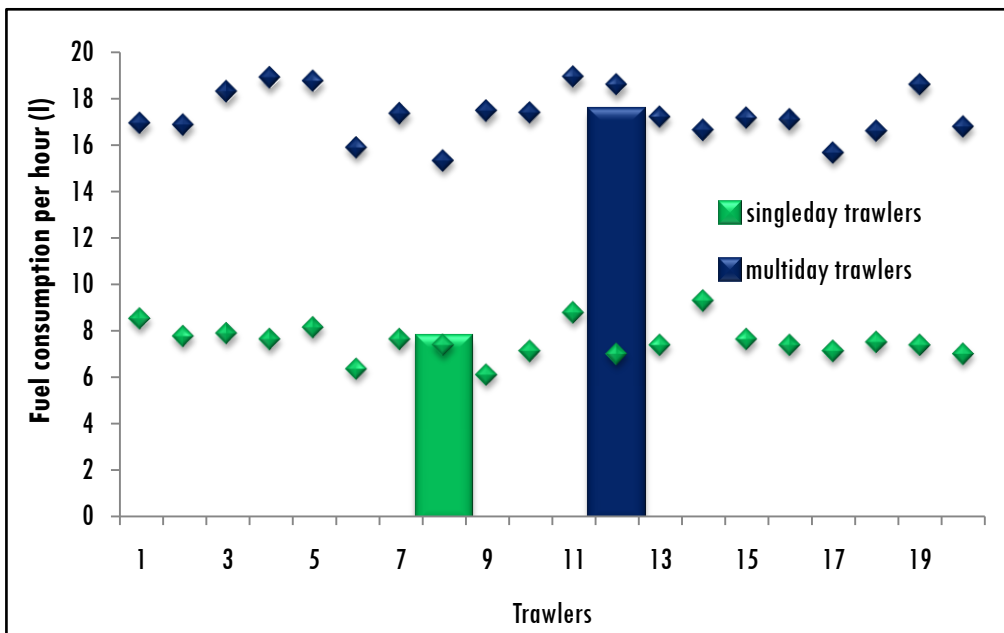

Fig.5.12 Comparison of fuel consumption per hour of single-day and multi-day trawlers (small trawlers) of Kerala [Bar graph shows the average fuel consumption per hour]

Among multiday trawlers, fuel consumption found to be increasing with the size of trawlers and engine power. Rate of fuel consumption is higher in very large trawlers, followed by large trawlers, medium trawlers and small trawlers. Fuel consumption per day is 582 litres in very large trawlers,; 361 litres in large trawlers, 225 litres in medium trawlers and 156 litres in small trawlers (Table 5.2 & Fig.5.13). Since there is variation in duration of operation in a day, fuel consumption per hour can be taken as the measure to compare the rate of fuel consumption between different length class of trawlers. It is 48.5 litres in very large trawlers, 30 litre for large trawlers, 20.5 litres for medium trawlers and 17.3 litres for small trawlers (Table 5.2 & Fig.5.14). Variation in fuel consumption per hour of different length class of trawlers has been statistically confirmed using t test and found to be significant (<0.00). If small trawlers are taken as a base to compare the rate of fuel consumption, it is 18.5% higher in medium trawlers, 74% higher in large trawlers and 180% higher in very large trawlers.

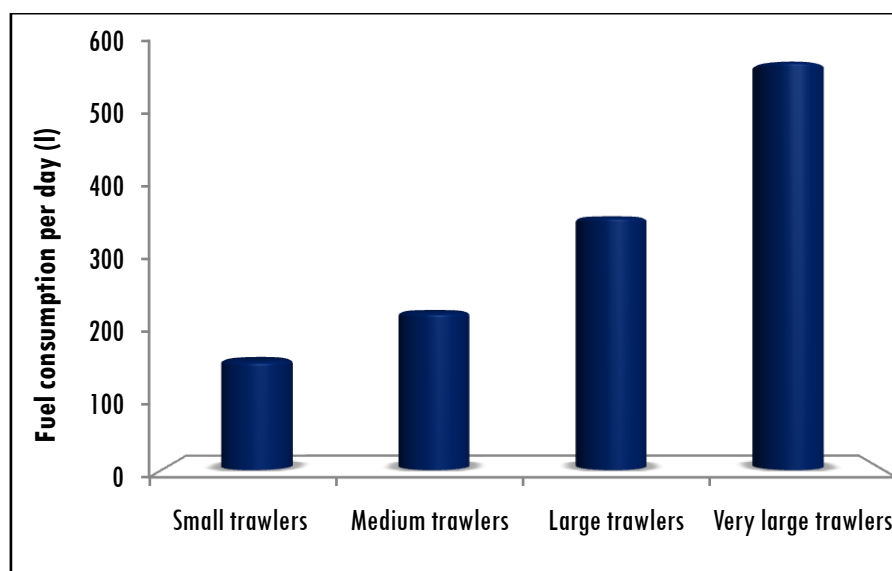

Fig.5.13 Average fuel consumption per day of multi-day mechanised trawlers

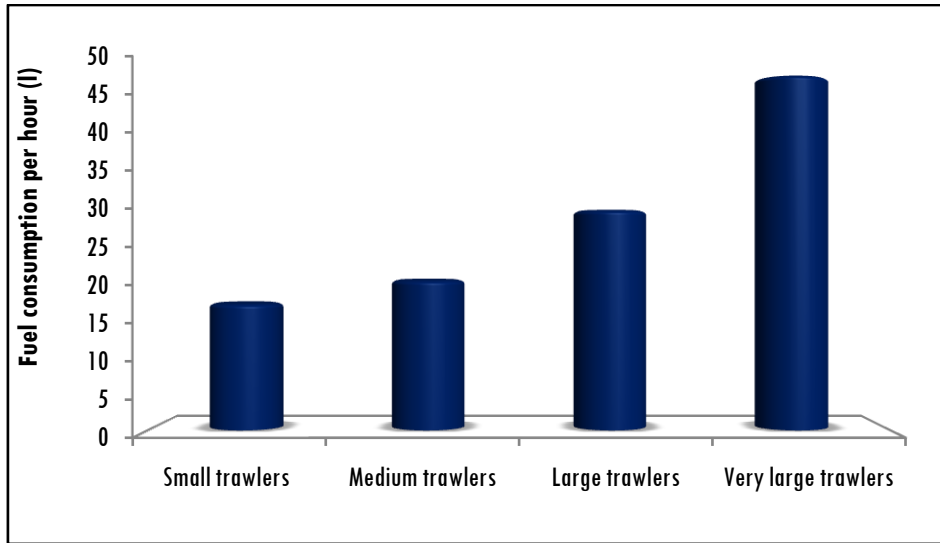

Fig.5.14 Average fuel consumption per hour of mechanised trawlers

Even though fuel consumption per trip cannot be used to compare the rate of fuel consumption, it can be depicted to understand the current profile of mechanised trawlers in Kerala. Fuel consumption per trip is 467 litres in small trawlers, 1125 litres in medium trawlers, 3611 litres in large trawlers and 6987 litres in very large trawlers (Table 5.2 & Fig.5.15). Cheilari *et al.* (2013) has specified a 10% reduction in fuel consumption for a difference of one day spent at sea, but present Kerala scenario showed more than 10% difference for one day. Finally average fuel consumption in a year per vessel is 12036 (0.01 million) litres for small trawlers (single-day), 35090 (0.035 million) litres for small trawlers (multi-day), 54722 (0.055 million) litres for medium trawlers, 90438 (0.09 million) litres for large trawlers and 146733 (0.15 million) litres for very large trawlers (Table 5.2 & Fig.5.16).

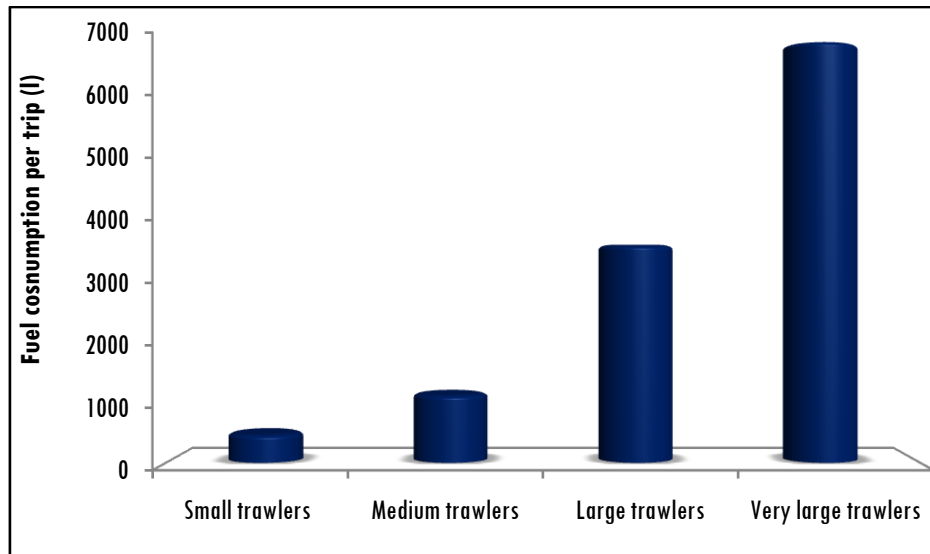

Fig.5.15 Average fuel consumption per trip of multiday trawlers

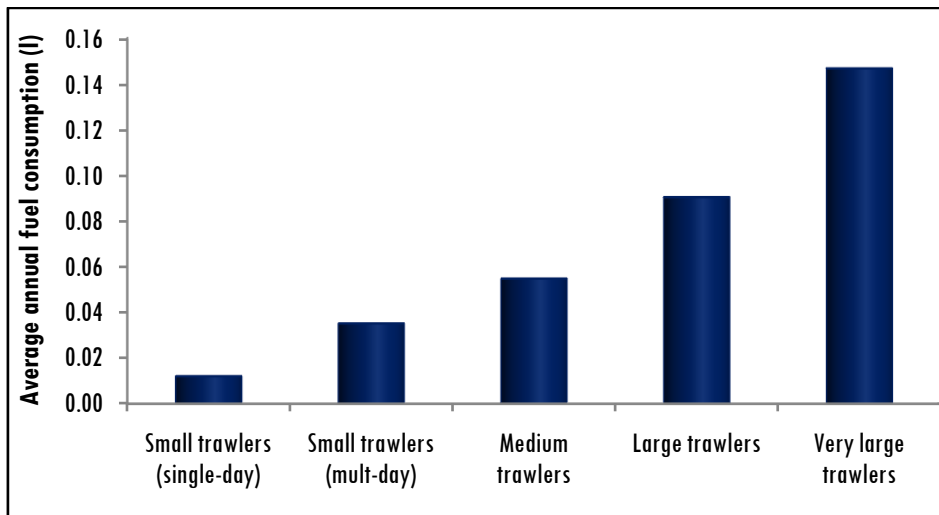

Fig.5.16 Average annual fuel consumption of mechanised trawlers of Kerala

Increased fuel consumption will reduce the profitability of fishing which will lead to hike in seafood price. The increased seafood price and alterations in fish supply will impart drastic socio-economic impacts in poor counties which rely heavily on fisheries for livelihood and food supply (Pelletier *et al.*, 2014). As India is such a country which depend deeply on

fisheries for employment and food security to a large extent, the energy cost is a concern among seafood consumers, seafood traders and fishing communities. Unal (2004) portrays the economics of trawl fishery in Foca (Turkey) and the findings are in accordance with the present Kerala scenario. Considerable variation in fuel consumption between trawlers depending on the abundance and characteristics of the target species, vessel and engine size, the degree of over capitalization, trip length, distance traveled to fishing grounds, the gear used, use of navigational equipment, weather conditions, time of the year and other technological aids have already been established (Hospido & Tyedmers, 2005; Ziegler & Hansson, 2003; Watanabe & Okubo, 1989; Mitchell & Cleveland, 1993; Tyedmers, 2001; Tyedmers, 2004; Thrane, 2004(a,b); Schau, 2012; Tietze *et al.*, 2005; Hollin & Windh, 1984; Aegisson & Endal, 1993; Parente *et al.*, 2008; Ziegler & Valentinsson, 2008 and Driscoll & Tyedmers, 2010).

How much fuel is consumed by mechanised trawl fishing fleet of Kerala in a year?

Mechanised trawlers being the single largest contributor to the marine fish landing of Kerala constituting 35-50% since introduction (Hassan & Sathiadhas, 2009) occupies 78% of mechanised vessels in the state (CMFRI, 2012). Values of annual fuel consumption by each category of trawlers are scaled up for entire mechanised trawl fishing fleet of Kerala using number of active mechanised trawlers in a year. The number of trawl fishing fleet in Kerala for the present year is unavailable; hence previously available estimates from published literature is used as recommended by Vázquez-Rowe *et al.* (2012). CMFRI (2012) reported that the number of mechanised trawlers in the state is 3678 and according to the present study 5% is small trawlers (single-day), 10% small trawlers (multi-day), 10% medium trawlers, 67% large

trawlers and 3% is very large trawlers. Among the 3678 trawlers reported along Kerala coast, approximately 2168 trawlers are active in a year (Ravi, 2015). Hence number of active trawlers in each category in a year can be estimated as 108 small trawlers (single-day), 325 small trawlers (multi-day), 217 medium trawlers, 1452 large trawlers and 65 very large trawlers.

An analysis of the fuel consumption by the entire mechanised trawl fishing fleet of Kerala is depicted in Table 5.3. As there are 108 single-day trawlers in the state consuming fuel at the rate of 12036 litres per vessel, total of 1304702 litres of fuel is consumed by these trawlers per annum. Accordingly, small trawlers (multi-day) consume 11411268 litres of fuel, medium trawlers consume 11863730 (11.86 million) litres, large trawlers consume 131144380 (131.14 million) litres and very large trawlers consume 9543449 (9.54 million) litres of fuel. Hence total fuel consumption by the mechanised trawl fishery of Kerala in a year during the study period can be estimated as 165267529 litres (165.3 million litres, 143711 tonnes, **1.4 million tonnes**). Hence it can be estimated that in total fuel consumption of Kerala trawl fishing fleet in a year, 0.8% is shared by small trawlers (single-day), 7% by small trawlers (multi-day), 7% by medium trawlers, 79% by large trawlers and 6% by very large trawlers (Fig.5.17).

Table.5.3 Estimated annual fuel consumption of mechanised trawl fishing fleet of Kerala

Type of trawler	Number of trawlers	Average annual fuel consumption (l)	Total annual fuel consumption (l)
Small trawlers (single-day)	108	12036	1304702.4
Small trawlers (multi-day)	325	35090	11411268
Medium trawlers	217	54722	11863730
Large trawlers	1452	90285	131144380
Very large trawlers	65	146732	9543449.3
Total	2168		165267529

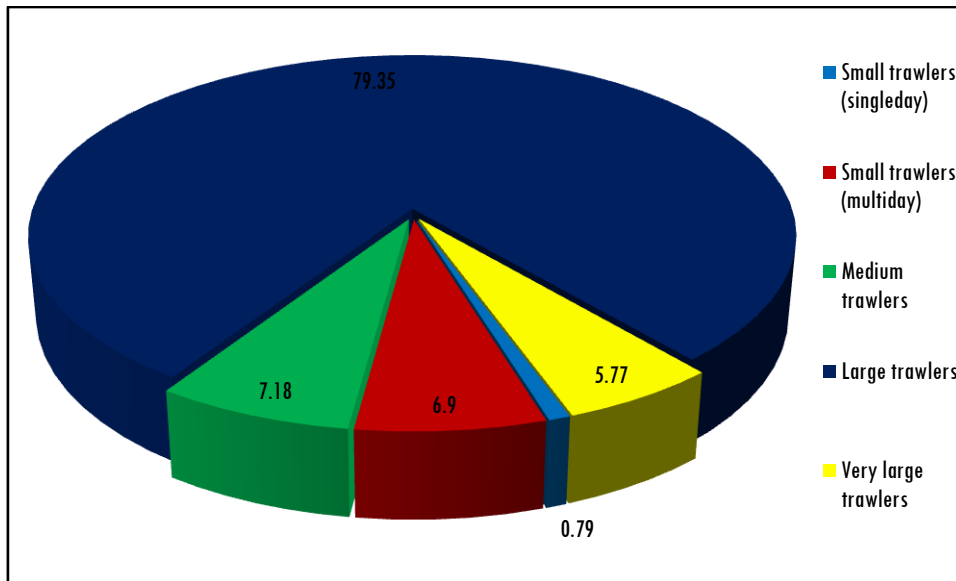

Fig.5.17 Estimated share of different length class of mechanised trawlers to the total annual fuel consumption by the trawl fishery of Kerala

5.3.2 Fuel efficiency of mechanised trawlers

Fuel efficiency is the amount of fuel burnt by fishing vessels to capture unit weight of fish (Tydemers, 2001 & 2004). It is an indicator of fuel efficiency of fishing vessels (Tydemers, 2004) which can be expressed as fuel use intensity or fuel efficiency. Fuel use intensity has been expressed in various terms in several studies; fuel used in litres per tonne of catch landed and fuel used in kilogram per kilogram of fish landed are the most common denotations for expressing fuel efficiency. In the present study, fuel use intensity of different length class of trawlers are estimated, it ranged from 555.55 to 1333.33 litre/tonne in small trawlers (single-day), 1090.9 to 3000 litre/tonne in small trawlers (multi-day), 300 to 2285.7 litre/tonne in medium trawlers, 245.4 to 1758.8 litre/tonne in large trawlers and 419.75 to 857.14 litre/tonne in very large trawlers (Table 5.4). Hence among mechanised trawlers in Kerala, average fuel use intensity found to be lowest in very large

trawlers (692.3 litre/tonne), followed by medium trawlers (734.22 litre/tonne), large trawlers (964.16 litre/tonne), small trawlers (single-day) (1011.24 litre/tonne) and small trawlers (multi-day) (1801.36 litre/tonne) (Table 5.4 & Fig.5.18). If an overall fuel use intensity of the mechanised trawlers in Kerala is estimated, it ranged from 245.4 to 3000 litre/tonne with an average of 831.2 litres/tonne of fish landed.

Trawlers and seiners are reported to be the most important fishing methods (Sainsbury, 1971) and with highest values of fuel use intensity or less fuel efficiency (Tyedmers, 2001). The results of the present study are in accordance with the findings of Cheilari *et al.* (2013) and Tyedmers (2001 & 2004) in which assessment of fuel use intensity of different fishing technique have been carried out. It was reported that for pelagic trawls average fuel use intensity is 670 l/tonne in 2008 varying from 79 to 3500 l/tonne (Cheilari *et al.*, 2013). Tyedmers (2001) reported the fuel use intensity of trawlers between 3000 and 3400 l/tonne of fish landed in a study based on North Atlantic fishery. Parker & Tyedmers (2015) estimated 639 litres of fuel use per tonne of fish landed on a global level and they also stated variation in fuel input by several order of magnitude in different fishing technique. Driscoll & Tyedmers (2010) evaluated the fuel use and carbon emission by the Atlantic Herring fleet during 1995 to 2006 and found out that single vessel mid-water trawler consumed 850352 litres of fuel in the year 2005 at the rate of 108 litre of fuel per tonne of catch. Rate of fuel consumption per fish landed was studied by Tyedmers (2001), Eyjólfsdóttir *et al.* (2003), Ziegler *et al.* (2003), Ellingsen & Aanonsen (2006), Guttormsdóttir (2009), Thrane (2004a,b), Ziegler & Hansson (2003), Schau *et al.* (2009), Iribarren *et al.* (2010), Emanuelsson *et al.* (2008), Parker & Tyedmers (2015) and Vázquez-Rowe *et al.* (2010).

Table 5.4 Fuel use intensity of mechanised trawlers (Average is shown in parenthesis)

Type of trawler	Fuel use intensity (l/t)
Small trawlers (Single-day)	555.55 – 1333.33 (1011.24)
Small trawlers (multi-day)	1090.9 – 3000 (1801.36)
Medium trawlers	300 – 2285.7 (734.22)
Large trawlers	245.4 – 1758.8 (964.16)
Very large trawlers	419.75 – 857.14 (692.3)
Mechanised trawlers (Kerala)	245.4 – 3000 (831.2)

European Commission proposed fuel efficiency of fish capture as an indicator of fuel efficiency of fishing vessels and its environmental burdens to measure the impact of fisheries (SEC, 2008). It is expressed as kilogram of fuel used to capture one kilogram of fish. For calculations, the amount of fuel in litre is converted to kilogram as 0.86kg per litre of diesel following Schau *et al.* (2009) which has been followed by Tyedmers (2001) and Cheilari *et al.* (2013).

In the present scenario of Kerala, the amount of fuel used to land one kilogram of fish in trawlers is 0.64 to 1.15 kg in small trawlers (single-day), 1.25 to 3.45 kg in small trawlers (multi-day), 0.34 to 2.63 kg in medium trawlers, 0.28 to 2.02 kg in large trawlers and 0.48 to 0.98 kg in very large trawlers (Table 5.5). On an average, the fuel efficiency in fish capturing shown by mechanised trawlers in Kerala is better in very large trawlers (0.8 kg per kg fish), followed by medium trawlers (0.84 kg per kg fish), large trawlers (1.1 kg per kg fish), small trawlers (single-day) (1.16 kg per kg fish) and small trawlers (multi-day) (2.07 kg per kg fish) (Table 5.5 & Fig. 5.19). If an overall Kerala scenario is considered, average fuel used to capture one kg of fish by mechanised trawlers is 0.96 kg which ranged from 0.28 to 3.45 kg.

Boopendranath (2000, 2008 & 2012) estimated fuel consumption rate as 0.41 kg per kg of fish landed in motorised mini trawling, 0.38 kg in small scale mechanised bottom trawling and 0.33 in large scale mechanised aimed

mid-water trawling in Kerala. Hence it can be concluded that fuel efficiency in fish capturing of mechanised trawlers in Kerala decreased almost 50% by these 17 years. Ravi (2015) also estimated fuel efficiency of mechanised trawlers in Kerala as 0.25 kg per kg fish in single-day trawlers and 0.43 kg per kg fish for multiday trawlers and together it is 0.41 kg per kg of fish landed.

Table 5.5 Fuel efficiency in fish capturing of mechanised trawlers
(Average is shown in parenthesis)

Type of trawler	Fuel efficiency in fish capturing (kg/kg)
Small trawlers (Single-day)	0.64 – 1.15 (1.16)
Small trawlers (multi-day)	1.25 – 3.45 (2.07)
Medium trawlers	0.34 – 2.63 (0.84)
Large trawlers	0.28 – 2.02 (1.1)
Very large trawlers	0.48 – 0.98 (0.8)
Mechanised trawlers (Kerala)	0.28 – 3.45 (0.96)

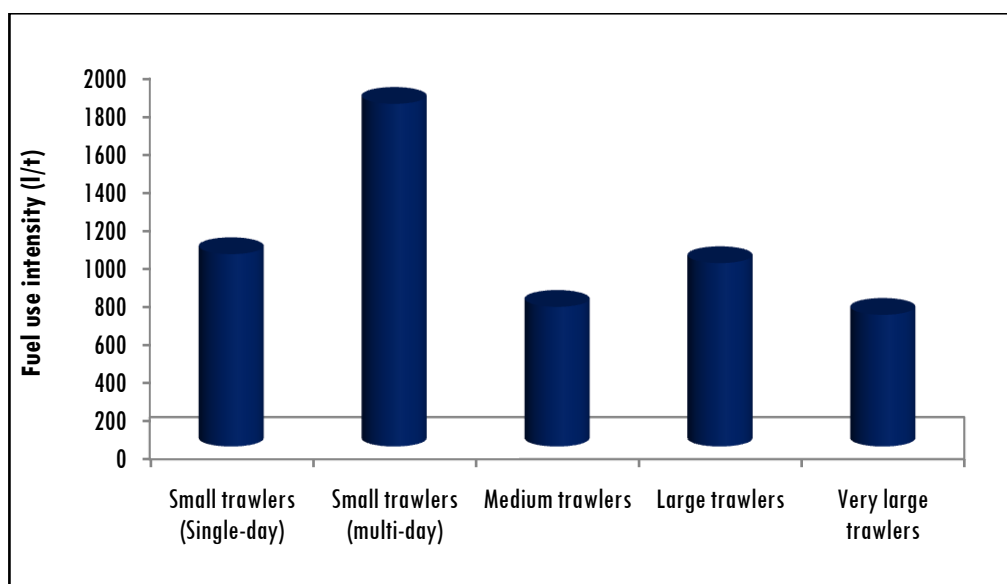

Fig.5.18 Average fuel use intensity of mechanised trawlers

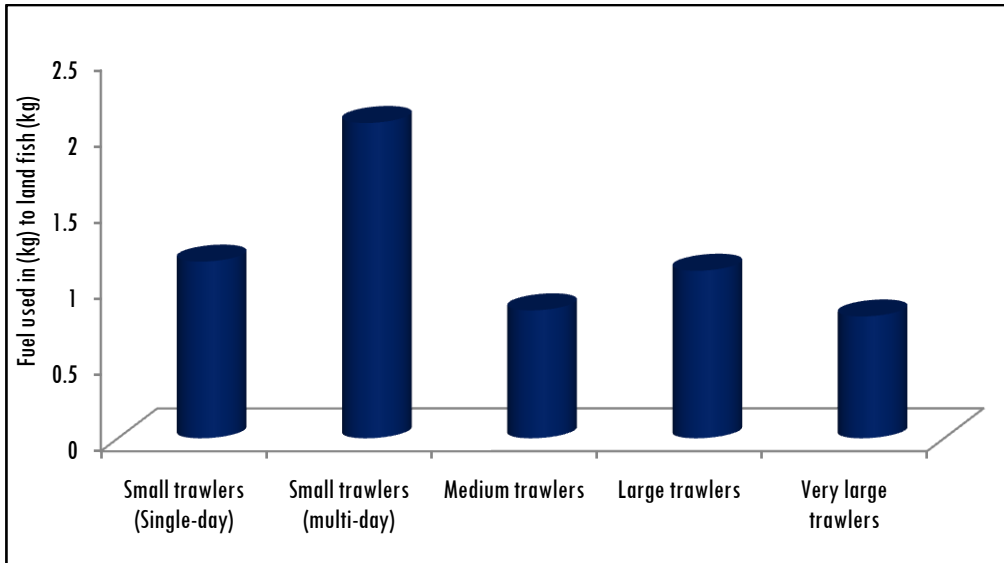

Fig.5.19 Average Fuel efficiency in fish capturing of mechanised trawlers

Fuel efficiency of various fisheries in different regions have been proposed by Tyedmers (2001) in which it was 0.44 kg/kg of fish in groundfish trawling, 0.76 kg/kg of fish in shrimp trawling and 0.85 kg/kg of fish in Norwegian lobster fishery. Tyedmers (2001), Eyjolfsdottir *et al.* (2003), Ziegler *et al.* (2003), Elingsen & Aanundersen (2006) and Guttormsdottir (2009) reported a value of 0.67kg of fuel per kg of fish landed regardless the technique used and region. Thrane (2004 a,b) estimated fuel intensity for Cod and flatfish as 0.4 and 0.84 kg respectively for kg of fish landed in Denmark. Thrane (2004b) and Iribarren *et al.* (2010) estimated fuel use for trawling for mackerel as 0.3 kg per kg of fish. In Senegal, artisanal trawling for shrimps and prawns has been estimated to consume fuel at the rate of 0.52 kg per kg of fish (Emanuelsson *et al.*, 2008). Schau *et al.* (2009) expressed the fuel use intensity as fuel use coefficient which is also expressed as kilogram of fuel used per kilogram of fish landed and it ranged from 0.09 to 1.01 for trawlers.

Another denotations of fuel efficiency have also been proposed by several experts. Thrane (2004b) has estimated fuel use intensity as fuel used in liter to catch one kilogram of fish and it ranged from 0.11 to 0.38 l/kg of fish and he also stated that apart from vessel size and gear employed, target species and its availability also influences fuel use intensity of fishing vessels. Among European Union fishing fleet fuel use intensity ranged between 3 and 25% during 2002-08 (Cheilari *et al.*, 2013).

5.3.3 Energy intensity in mechanised trawlers

Generally the energy requirement can be measured in a wide perspective which includes fishing vessel construction and fitting out, fishing gear manufacture and operational energy requirement. But in present study a narrower analysis of energy intensity is carried out, that is energy intensity exclusively from fuel use is estimated. Energy input in the form of fossil fuel account for 75 to 90% of total energy inputs in the form of direct and indirect energy and the rest is constituted by energy inputs associated with vessel construction and maintenance, fishing gear fabrication and repair and other factors of operation (Wiviott & Mathews, 1975; Rochereau, 1976; Leach, 1976; Edwardson, 1976; Rawitscher 1978; Lorentzen, 1978; Allen, 1981; Watanabe & Uchida, 1984; Watanabe & Okubo, 1989 and Tyedmers, 2000).

In the present study energy input and energy intensity of different length class of mechanised trawlers in Kerala for an year is estimated. Energy in the form of fossil fuel utilised in a year varied from 18.4 to 33.13 GJ in small trawlers (single-day), 44.17 to 73.62 GJ in small trawlers (multi-day), 22.09 to 84.66 GJ in medium trawlers, 29.45 to 73.62 GJ in large trawlers and 62.58 to 110.43 GJ in very large trawlers (Table 5.6). Hence it can be said that a mechanised trawler in Kerala utilizes an average of 50.42 GJ energy in a

year in the form of fossil fuel which varied from 18.4 to 110.43 GJ depending on their size.

Energy intensity of a fishery can be defined as the energy requirement to produce a unit weight of fish (Tyedmers, 2004). It can be measured as total joules of energy required to land a live weight of fish. Usually it is expressed in Giga Joule of energy per tonne of fish landed (GJ/t) or Mega joules of energy per kilogram of fish landed (MJ/kg). For the calculations, energy utilization per litre of diesel used was taken as 36.81 MJ as described by Schau *et al.* (2009). Mittal & Dhawan (1988) and EMC (1991) have also proposed a value of 56.3 MJ per litre of diesel but avoided as it is older and there are chances to change because of advancements in technology.

Energy intensity of vessels is varying with type of gear used among which trawl found to be more energy intensive compared to seining, gillnetting and trapping (Wiviott & Mathews, 1975; Leach, 1976; Edwardson, 1976; Lorentzen, 1978; Rawitscher, 1978; Nomura, 1980; Hopper, 1982 and Watanabe & Okubo, 1989). Energy intensity of different category of mechanised trawlers in Kerala is estimated; it ranged from 20.45 to 49.08 GJ/t in small trawlers (single-day), 40.16 to 78.88 GJ/t in small trawlers (multi-day), 11.04 to 84.14 GJ/t in medium trawlers, 11.09 to 64.74 GJ/t in large trawlers and 15.45 to 31.55 GJ/t in very large trawlers (Table 5.6). On an average it can be estimated that very large trawlers showed lowest energy intensity (25.48 GJ/t) followed by medium trawlers (27.03 GJ/t), large trawlers (36.6 GJ/t), small trawlers (single-day) (37.22 GJ/t) and small trawlers (multi-day) (54.93 GJ/t) (Fig.5.20).

Considering an overall scenario of Kerala the average energy intensity of mechanised trawlers is estimated to be 36.25 GJ/t with a range of 11.04 to

84.14 GJ/t. Variation in energy intensity associated with the size of the fishing vessel has been reported by Wiviott & Mathews (1975), Rochereau (1976), Lorentzen (1978) and Watanabe & Okubo (1989) but the results of Edwardson (1976) is an exception. According to the study conducted by Cheilari *et al.* (2013) in large pelagic trawlers of more than 40 m L_{OA}, energy intensity ranged from 2 to 4 GJ/tonne of fish landed.

Table 5.6 Energy input (per year) and energy intensity of different length class of mechanised trawlers in Kerala for one year (Average is given in parenthesis)

Type of trawler	Energy input (GJ)	Energy intensity (GJ/t)
Small trawlers (Single-day)	18.4-33.13 (26.99)	20.45 - 49.08 (37.22)
Small trawlers (multi-day)	44.17 – 73.63 (53.01)	40.16 - 78.88 (54.93)
Medium trawlers	22.09 – 84.66 (50.1)	11.04 - 84.14 (27.03)
Large trawlers	29.45 – 73.62 (49.12)	11.09 - 64.74 (36.6)
Very large trawlers	62.58 – 110.43 (82.21)	15.45 - 31.55 (25.48)

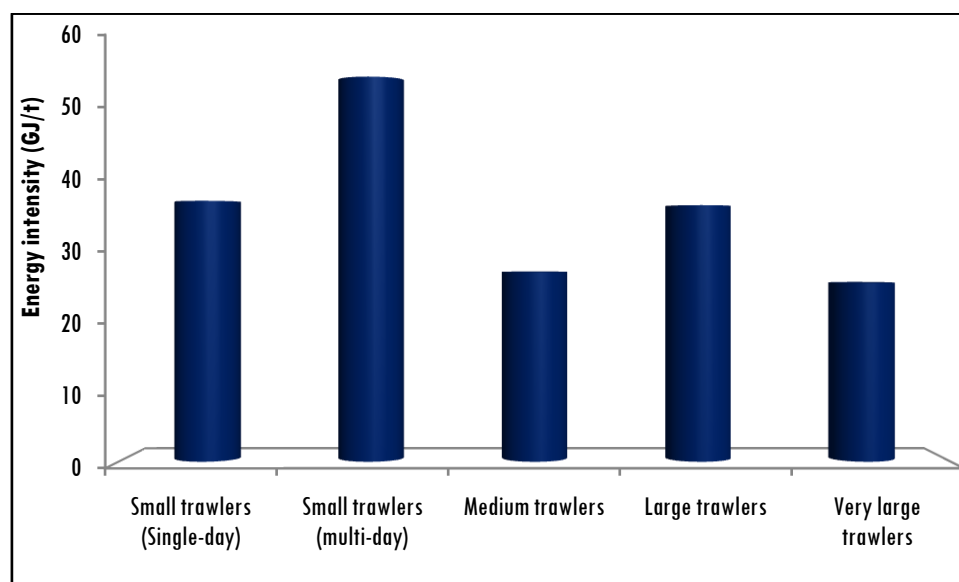

Fig.5.20 Energy intensity level of different category of mechanised trawlers in Kerala

In Indian and Kerala scenario, studies on energy intensity especially in fisheries sector rare. Studies on fuel consumption and conservation are more or less advanced but studies on energy aspect is less. Boopendranath (2000) estimated the energy requirement in fish harvesting systems of Kerala and trawlers found more energy intensive. According to him, among the operational inputs contributing to energy input in wooden trawlers, diesel constituted 85.7 % which is equivalent to 26.91 GJ of energy and the energy intensity estimated was 7.69 GJ per tonne of fish landed. At present in wooden trawlers of Kerala average energy intensity is estimated as 37.22 GJ/t showing a fivefold decline in energy efficiency. In case of steel trawlers, fuel found to be contributing 84.5 % of total energy requirement and energy intensity was estimated as 8.91 GJ per tonne of fish landed (Boopendranath, 2000). In the present study, average energy intensity of steel trawlers is estimated at 36.01 GJ/t which showed a fourfold decline in energy efficiency since 2000.

Globally studies on energy requirement for fishing are well established and there are studies on a wide perspective of energy input. The results obtained regarding energy intensity of Kerala trawlers is in accordance with the findings of Cheilari *et al.* (2013), Dutilh & Kramer (2000), Watanabe & Okubo (1989), Leach (1976) and Hirst (1974). They have studied the energy intensity per kilogram of fish landed in various regions and time. Cheilari *et al.* (2013) estimated the energy intensity of European Union fishing fleets as 24.65 GJ/t during 2008 regardless the fishing method used and in case of trawlers it ranged from 26.19 to 150.13 GJ/t in various years in different length class of vessels. Dutilh & Kramer (2000) estimated the energy requirement in Holland fisheries as 20 to 40 MJ per kg of fish. Watanabe & Okubo (1989) estimated energy input to fish one kilogram of seafood in Japanese fishery using different fishing techniques as 0.05×10^4 kcal to 3.5×10^4 kcal. Leach (1976) studied the energy intensity in UK fishing fleet as 32.66

GJ/tonne and 36.01 GJ/tonne in Maltese waters. Hirst (1974) estimated an energy intensity level of 41.87 GJ per tonne of fish landed in USA.

5.3.4 Environmental burdens of mechanised trawlers

Commercial fisheries is exclusively dependent upon fossil fuel for navigation, operation and any other activities which require energy. Fuel use contribute heavily to the emission of green house gases that will make dramatic changes in the atmosphere and climate. Green house gas emission from a fishery is a function of different variables among which fuel is found to be prominent. Carbon footprint is a measure of carbon emission caused by an activity directly or indirectly (Wiedmann & Minx, 2008). Here a narrower analysis has been carried out on carbon footprint of mechanised trawlers through fuel use. Heavy dominance of fuel use in environmental burdens caused by a fishing vessel has been reported by Ravi (2015), Boopendranath (2000, 2008 & 2012), Ziegler & Valentinsson (2008), Ziegler *et al.* (2009), Vaquer-Rowe *et al.* (2010 & 2012), Vivekanandan *et al.* (2013), Ziegler *et al.* (2003), Thrane (2004a,b), Hospido & Tyedmers (2005) and Edwardson (1976).

Carbon footprint can be expressed in terms of carbon emission from a vessel in a year and amount of carbon emission per unit weight of fish landed. Since energy consumption has a direct impact on environment, carbon emission can be used as an indicator of environmental burdens of the system (Dutilh & Kramer, 2010) and it is an indicator of fuel or energy efficiency and environmental burden created by a system.

Annual carbon emission from different length class of trawlers has been estimated in kilogram CO₂ equivalent. The carbon emission associated with fuel use is calculated based on the data published by Environmental Protection Agency of US in which equivalent carbon emission of one litre of diesel use is defined as 2.7 kg (USEPA, 2014). Tyedmers (2001) calculated

carbon emission as 2.66 kg of CO₂ per litre of diesel used. As it is older and updated data are available, most recent available data is used. Average carbon emission per vessel per year can be estimated as 32497 kg from small trawlers (single-day), 94743 kg from small trawlers (multi-day), 147749 kg from medium trawlers, 243769.5 kg from large trawlers and 396176 kg from very large trawlers (Table 5.8). Hence total carbon emission through fuel use of trawl fishing fleet of Kerala can be estimated as 446222330 kg (**0.45 million tonnes**) (Table 5.8). Ravi (2015) stated that fuel is consistently found to account for a large proportion of carbon emission in fisheries and carbon emission through fuel use of Kerala trawlers was 0.28 mt of CO₂ in a year.

Table 5.7 Average annual carbon emission from mechanised trawlers

Type of trawler	Average carbon emission (kg)	No. of active trawlers in a year	Total carbon emission in a year
Small trawlers (single-day)	32497.2	108	3522696.48
Small trawlers (multi day)	94743	325	30810423.6
Medium trawlers	147749.4	217	32032071
Large trawlers	243769.5	1452	354089826
very large trawlers	396176.4	65	25767313.11
Total		2167	446222330.2

Considering carbon emission per kilogram of fish landed, it varied from 1.5 to 3.6 kg in small trawlers (single-day), 2.95 to 5.79 kg in small trawlers (multi-day), 0.81 to 6.17 kg in medium trawlers, 0.66 to 4.75 kg in large trawlers and 1.13 to 2.31 kg in very large trawlers (Table 5.8). Average carbon emission per kilogram of fish landed is higher in small trawlers (multi-day) (4.03 kg) followed by small trawlers (single-day) (2.73 kg), large trawlers (2.6 kg), medium trawlers (1.98 kg) and very large trawlers (1.87 kg) (Fig.5.21). Among different size class of trawlers, very large trawlers found to be efficient by releasing least carbon per fish landed as a result of higher quantity of catch.

Considering Kerala trawl fishery, on an average it released 0.45 million tonnes of carbon in a year during the study period at an average rate of 2.24 kg of carbon per kg of fish landed and 206 tonnes of carbon emission per mechanised trawler per year. The contribution of multi-day trawlers to the emission of carbon to the atmosphere is very high when compared to single-day trawlers; multi-day trawlers emit 48% more carbon per kg of fish landed. Ravi (2015) also reported a similar trend among mechanised trawlers in the state.

Table 5.8 Carbon emission per kilogram of fish landed from mechanised trawlers (Average is given in parenthesis)

Type of trawler	Carbon emission per fish landed (kg/kg)
Small trawlers (Single-day)	1.5 - 3.6 (2.73)
Small trawlers (multi-day)	2.95 - 5.79 (4.03)
Medium trawlers	0.81 - 6.17 (1.98)
Large trawlers	0.66 - 4.75 (2.6)
Very large trawlers	1.13 - 2.31 (1.87)
Mechanised trawlers (Kerala)	0.66 - 8.1 (2.24)

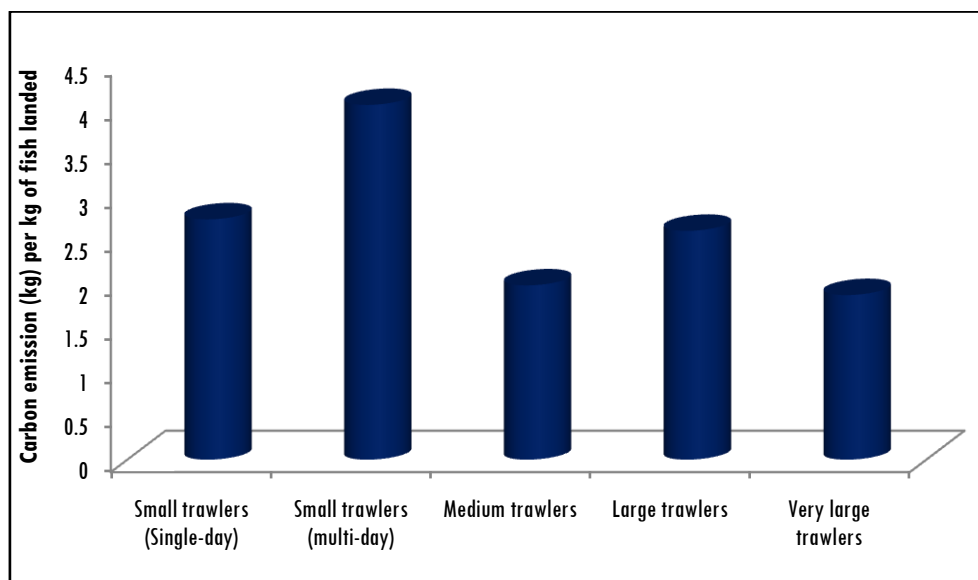

Fig.5.21 Average carbon emission per kilogram of fish landed from mechanised trawlers

Ravi (2015) conducted lifecycle assessment of mechanised trawlers in Kerala and estimated that 1.674 tonne of CO₂ is released per tonne of fish landed. Findings of Boopendranath (2000), Tyedmers *et al.* (2005) and Vivekanandan *et al.* (2013) also showed similar trend. Vaquez-Rowe *et al.* (2010) estimated carbon emission of horse mackerel fishery through bottom trawlers as 2.3 tonne per tonne of fish landed. Vivekanandan *et al.* (2013) has estimated carbon emission from Indian marine fishing fleets as 3.13 million tonnes in 2010 at an average rate of 1.02 tonnes of CO₂ per tonne of live-weight of marine fish landed. Boopendranath (2000) estimated amount of CO₂ released into the atmosphere through fuel use as 3.17 million tonnes at an average rate of 1.13 tonnes of CO₂ per tonne of marine fish landed.

Cheilari *et al.* (2013) estimated average rate of carbon emission of European fishing fleets in 2008 as 1.8 kg/kg of fish varying from 0.21 to 9.5 kg/kg of fish depending on the size of vessel. An average estimation of carbon emission from the same was estimated at 3,580,000 kg CO₂ in a year at the rate of 337 kg CO₂ per tonne of catch landed. Fet *et al.* (2010) estimated the carbon footprint of one kg of fish fillet produced from a pelagic fish landed in Norway and sold in France as 1.04 kg of CO₂.

5.4 Conclusion

Globally fisheries is facing concerns in the form of sustainability issues; recently various management efforts are initiated to address these issues. Increased rate of fuel consumption and resultant burdens contribute to worsen the scenario. All specified concerns are most prominent in trawling industry which is the most common and dominating worldwide. Rate of fuel consumption of mechanised trawlers in Kerala, its fuel use intensity, energy intensity and rate of carbon by mechanised trawl fleet are estimated in the

chapter. An estimation of total fuel consumption and carbon emission of mechanised trawl fishing fleet of Kerala in a year is also carried out. Rate of fuel consumption found to be higher in very large trawlers and lower in small trawlers; 48.5 litres per hour in very large trawlers, 30.1 litres per hour in large trawler, 20.45 litres per hour in medium trawlers, 17.3 litres per hour in small trawlers (multi-day) and 7.5 litres per hour in small trawlers (single-day). Fuel efficiency is higher in very large trawlers followed by medium trawlers, large trawlers, small trawlers (single-day) and small trawlers (multi-day). On an average fuel efficiency of mechanised trawlers in Kerala regardless the size is estimated as 0.96 kg per kg of fish landed with a range of 0.28 to 3.45 kg. An analysis of energy input has been considered in a narrower perspective in which energy input in the form of fossil fuel is conducted which proved that a mechanised trawler in the state require 18.4 to 110.43 GJ of energy in a year for operation. Since small trawlers are conducting both single-day and multi-day operations, they are used to compare the fuel consumption and efficiency between single-day and multi-day operations. While comparing single-day trawlers found to be better in all aspects; rate of fuel consumption found to be 57% lesser in single-day trawlers; fuel efficiency is 1.16 kg/kg in single-day trawlers and 2.07 kg/kg in multi-day trawlers. Energy intensity, the amount of energy required to land a one kg of fish is also assessed which is in similar order of fuel efficiency; it is estimated that 36.25 GJ of energy is spent in the form of fossil fuel to land one kg of fish by a mechanised trawler in a year which ranged from 11.04 to 84.14 GJ/t. Fishing has different dimensions of impact including on environment and economy which cannot be neglected. Good energy performance is required to attain sustainability in environmental, economical and social aspects. On an average mechanised trawlers in Kerala consumed 165.3 million litres of fuel annually during the period of study at an

average rate of 0.96 kg per kg of fish landed which ranged from 0.28 to 3.45 kg. Regarding carbon emission, Kerala trawl fishery released 0.45 million tonnes of carbon in a year exclusively through fuel use at the rate of 2.24 kg CO₂ per kg of fish landed during the period of study. Comparing different length class of trawlers, it is understood that rate of carbon emission is least in very large trawlers (1.87 kg per kg of fish) followed by medium trawlers (1.98 kg per kg of fish), large trawlers (2.6 kg per kg of fish), small trawlers (single-day) (2.73 kg per kg of fish) and small trawlers (multi-day) (4.03 kg per kg of fish). Comparing single-day and multi-day trawlers of similar size, latter found to be emitting 48% more carbon per kg of fish landed.

...SOQ...

ECONOMIC PERFORMANCE OF MECHANISED TRAWLERS IN KERALA WITH SPECIAL EMPHASIS ON FUEL COST

6.1 Introduction

Marine capture fisheries play a vital role in the economy of Kerala, apart from agriculture and is recognized as a major contributor to the state revenue. Commensurate with the technological complexity, volume of investment also got accelerated in the sector. Overcapitalization in association with increase in number of fishing vessels resulted in bio-economic unsustainability in marine fisheries sector of the state (Aswathy *et al.*, 2011). At present various kinds of fishing vessels ranging from non-motorised country crafts to mechanised vessels which are fishing beyond our country limits are prevalent in the state. Difference in capturing techniques and socio-economic status of fishers who are associated with different technique leads to enterprise clashes among fishermen. Advanced technologies have better access to resources which led to increment in cost of fishing. A fishery can be considered optimum or successful only if it lowers the production cost per fish landed or increase the productivity at the same cost. All these necessitate studying the economic performance of a fishing system without which a complete understanding of the system is not possible.

Pattern of investment and cost differ in various fishing techniques and even within a fishing system it varies based on length overall and operational aspects. In addition to technical efficiency, economic efficiency also influence the sustainability of a fishing system and are equally important. Economic health of global fisheries is in a status of steep declining which resulted from the action of a group of factors together which include depleted stock, increased effort, decreased catch and excess capacity of fishing fleets (World Bank, 2008). The size and technical specifications of trawlers determines the depth and duration of trawling which in turn influences its economic feasibility. Economic research in fisheries field has a significant role in forecasting suitable policy measures and future planning related decisions. To instrument sustainable exploitation patterns and designing management decisions, an understanding of nature and degrees of investment and cost is crucial (DFID 2004). Economics of trawlers operated along Indian coast was studied by Sathiadhas & Panikkar (1989), Sathiadhas *et al.* (1992), Senthilathiban *et al.* (1996), Senthilathiban *et al.* (1997), Sehara & Kanakkan (1993), Senthilathiban *et al.* (1999) and Kunjir *et al.* (2007). In Kerala marine fisheries sector, economics of trawlers have been analysed by Devaraj & Smita (1988), Sehara *et al.* (1991), Aswathy *et al.* (2011), Unnithan *et al.* (2004), Hassan & Sathiadhas (2009) and Shanis (2014). Economic performance of fishing units can be evaluated by estimating cost and earnings per trip or year. In the present study an attempt is made to portray the economic performance of mechanised trawlers in Kerala on an annual basis according to their size.

6.2 Material and methods

A survey conducted in major mechanised trawl landing centres of the state viz., Neendakara, Sakthikulangara, Cochin, Munambam, Beypore, Puthiyapa and Chombal during November, 2016 to June, 2017 is the method adopted for data collection. A minimum of 10 trawlers in each category were surveyed from every selected centres. A structured survey schedule was prepared, pre-tested and used to collect data on initial investment, amount spent for insurance and interest on capital in a year and operational expenditure. The data has been collected from the register maintained onboard or by the boat owner using structured questionnaire (Annexure IV). Additionally, the investment and cost of 40 selected trawlers which were selected for studying fuel consumption was also collected. The operational cost includes cost incurred for fuel, oil, ice, auction, provisions, maintenance and repair, daily allowance, crew share, and miscellaneous cost. Details of data collection and analysis have been explained in section 2.2.3.

6.3 Results and discussion

Economic performance of mechanised trawlers in Kerala is depicted which is influenced by both level of technology and scale of operation. Within the mechanised sector, cost incurred for fixed assets and operation varied widely according to the size of trawler, hence data were collected separately for different length class of trawlers. Results included are capital investment, annual fixed cost, operational cost, total annual cost and economic efficiency parameters such as gross profit (net operating income), net profit, rate of return on investment, profitability ratio, net profit ratio, operating ratio and pay-back period. Unnithan *et al.* (1985), Aswathy *et al.* (2011), Xavier (2013) and Shanis (2014) also conducted studies on similar aspects. An

analysis on role of fuel cost in profitability of trawlers are also carried out in the form of share of fuel cost in operational cost and revenue. Termination of less efficient fishing units in all category of fishing which are forced to go out has been stated by Sathiadhas & Narayanakumar (2001).

6.3.1 Capital investment

Capital investment is the cost incurred for fixed assets; for purchasing vessel, engine, gear and other accessories. The cost for modifications just after purchase of vessel and gear also comes under the head capital investment (Xavier, 2013). Hence sub categories included in capital cost are cost of vessel, cost of engine, cost of gear and accessories and cost of modifications after purchase (Kurien & Willmann, 1982; Unnithan *et al.*, 1985; Aswathy *et al.*, 2011; Xavier, 2013 and Shanis, 2014). The cost for purchase or construction of a new trawler in Kerala showed higher values compared to previous studies (Unnithan *et al.*, 1985; Devaraj & Smita, 1988; Sehara & Kanakkan, 1993; John, 1996; Kurien & Willmann, 1982; Kurup & Radhika, 2007; Najmudeen & Sathiadhas, 2007; Sehara & Kanakkan, 1992; Xavier, 2013; John, 1996 and Shanis, 2014). The capital cost for trawlers in the state at present ranged from 0.455 million rupees to 13.74 million rupees according to the size of trawlers. At present in Kerala, capital investment for very large trawlers is highest (13.74 million rupees) followed by large trawlers (12.85 million rupees), medium trawlers (7.46 million rupees) and small trawlers (multi-day) (1.5 million rupees) and small trawlers (single-day) (0.455 million rupees). The distinguishing factor between small trawlers (single-day) and small trawlers (multi-day) is material of construction, single-day trawlers are constructed with wood and multi-day trawlers are constructed using steel.

Table 6.1 and Fig.6.1 gives profile of capital investment for mechanised trawlers in Kerala. In accordance with the previous studies, major share of the capital cost in multiday steel trawlers is incurred for vessel construction (78%) followed by cost of engine (15%), cost of trawl net (4%) and cost for modifications after purchase (3%) (Fig.6.2). Wooden trawlers are an exception, where cost of trawl nets constitutes major share in capital investment (44%), followed by cost of vessel (26%), cost of engine (22%) and modifications (5%) (Fig.6.3). Most of the wooden trawlers were more than 15-20 years old and only small trawlers comes under the category, hence cost of wooden trawlers are lesser than cost for a new set of trawl nets. However, the results are in accordance with the findings of Aswathy *et al.* (2011) who also reported that most of the single-day trawlers are constructed using wood. Cost of vessel were same as previous studies in case of wooden trawlers, but the cost of engine showed large hike from 2007 which resulted in an increment of capital investment. Hence it can be concluded that there is almost 50 to 100% increase in capital cost of trawlers during the last decade.

Table 6.1 Average capital investment for mechanised trawlers in Kerala

Items	Small trawler (single-day)	Small trawler (multi-day)	Medium trawler	Large trawler	Very large trawler
Trawler (₹)	120000	1240000	5350000	10060000	10625000
Engine (₹)	100000	100000	1494500	2152375	2221560
Trawl net and accessories (₹)	200000	30000	564000	403300	650500
Modifications (₹)	25000	113500	49500	237800	243750
Total (₹)	455000	1483500	7458000	12853475	13740810

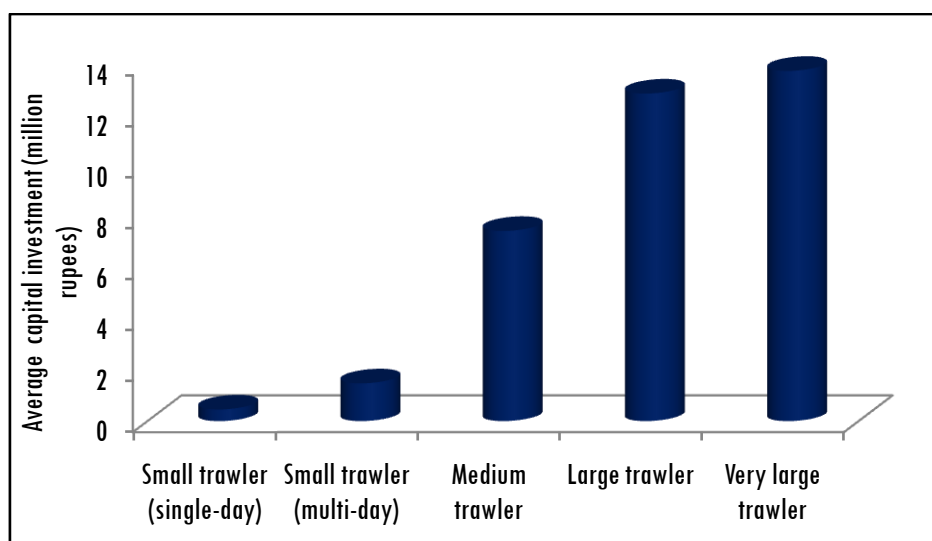

Fig.6.1 Capital investment of mechanised trawlers in Kerala

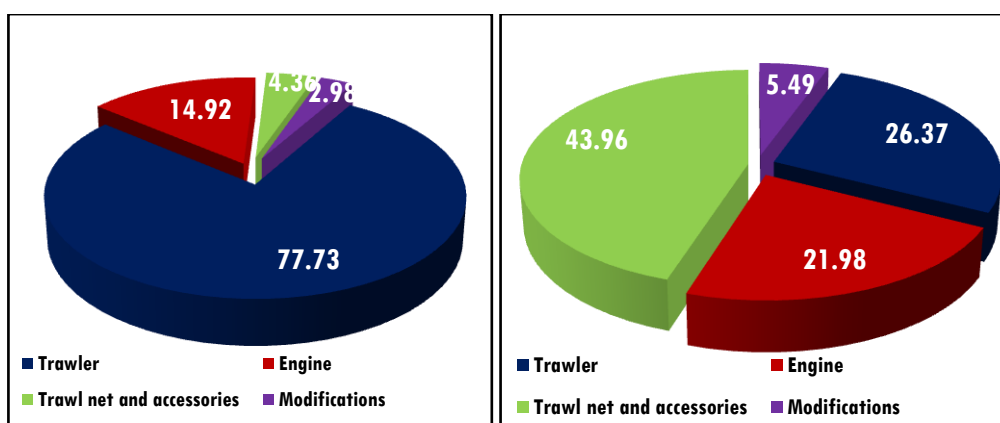

Fig.6.2 Share of items of capital investment for mechanised trawlers (steel) in Kerala

Fig.6.3 Share of items of capital investment for mechanised trawlers (wood) in Kerala

6.3.2 Annual Fixed cost

Fixed cost is calculated on annual basis which includes interest paid on capital, cost of insurance, and cost of depreciation. The annual fixed cost of mechanised trawlers in Kerala at present ranged from 0.3 million rupees to 2.5 million rupees. Average annual fixed cost of mechanised trawlers in the state

can be estimated to be 0.3 million rupees in small trawlers (single-day), 1.02 million rupees in small trawlers (multi-day), 1.54 million rupees in medium trawlers, 2.39 million rupees in large trawlers and 2.5 million rupees in very large trawlers (Table 6.2 and Fig.6.4). The contribution of each component to the fixed cost of trawlers is, 41.37% is interest on loan, 57.83% is depreciation and 0.03% is insurance. Interest on capital varied from 3 to 5% in different regions and the borrowed amount varied Rs.1000000 to Rs.5000000. Most of the entrepreneurs in fishing sector are drawing loan either from private sector banks or from personnel who are associated with finance services. Amount of interest on capital varied from 0.18 to 1.04 million in different trawlers. One of the peculiar thing noted during the study is, not a single trawler is insured with private sector insurance companies; as there are problems from both company and fishermen side. Companies are not providing insurance to fishing vessels, because if the dimension of damage is very high they cannot afford the cost. From the fishermen side, they are getting insurance with very low cost through Matsyafed hence they are in no need of other insurances. The cost of insurance provided by Matsyafed varied from 250 rupees to 350 rupees for a year depending on the size of the vessel. Hence the percentage contribution of insurance to the annual fixed cost is negligible. Cost of depreciation was estimated using straight line method in which it is calculated using cost of each item at the time of purchase, its salvage value (residual value) and its expected life in years. Results of the present study are in accordance with the findings of Aswathy *et al.* (2011), Unnithan *et al.* (1985), John (1996), Sehara & Kanakkan (1993), Sehara & Kanakkan (1993) and Panikkar *et al.* (1991).

Table.6.2 Annual fixed cost of mechanised trawlers of Kerala

Items	Small trawler (single-day)	Small trawler (multi-day)	Medium trawler	Large trawler	Very large trawler
Interest on capital (₹)	180000	258000	588000	1015200	1038000
Insurance (₹)	250	250	350	350	350
Depreciation (₹)	111333	763500	949667	1373953.333	1461542
Total (₹)	303250	1021750	1538017	2389503	2499892

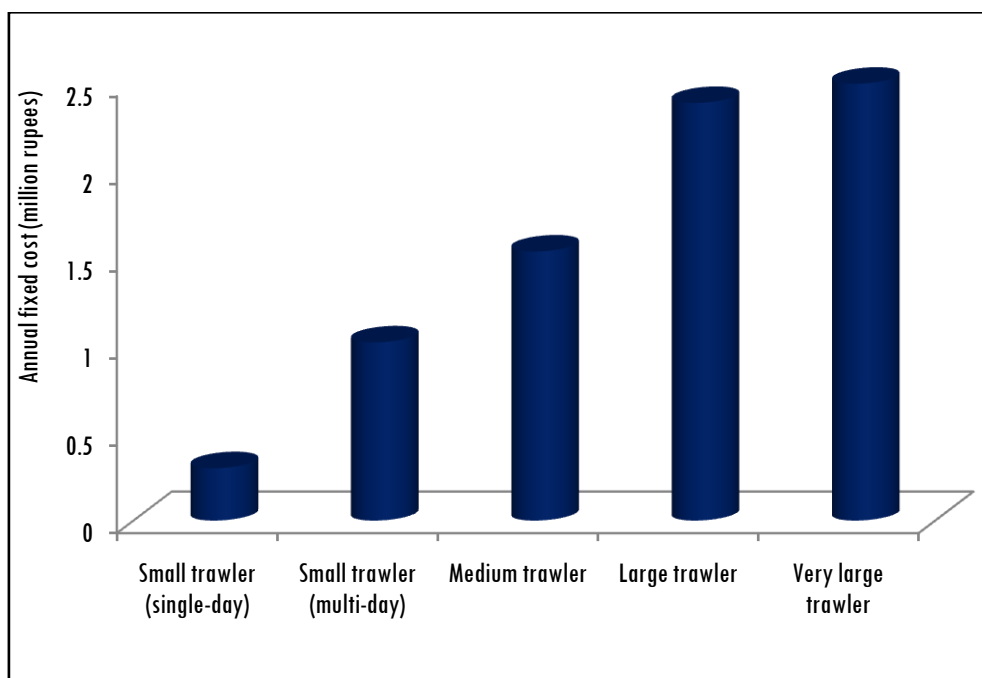
**Fig.6.4** Annual fixed cost of mechanised trawlers in Kerala

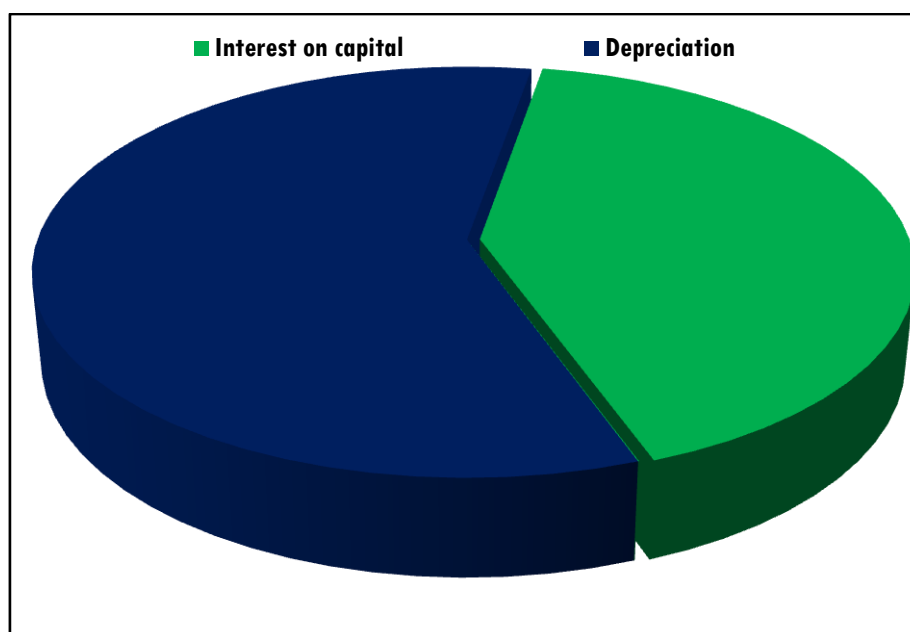

Fig.6.5 Percentage contribution of items to total fixed cost in mechanised trawlers in Kerala

6.3.3 Operational cost

Operational cost is the expense incurred for operational inputs which include cost of fuel, wages, daily allowance and food for fishermen, ice and baskets, lubrication oil, landing charges, auction charges, repair and maintenance and miscellaneous costs. On an average, operational expenditure of trawlers for a year is 1.21 million rupees for small trawlers (single-day), 2.84 million rupees for small trawlers (multi-day), 6.38 million rupees for medium trawlers, 10.1 million rupees for large trawlers and 14.52 million rupees for very large trawlers (Table 6.3 and Fig.6.6). Average contribution of each components to the operational cost of trawlers is 51% is fuel cost, fishermen share is 27%, 13% is cost of repair and maintenance; 4% is cost of ice and baskets; 3.68% is auction charge and remaining 2% is incurred by cost for lubrication oil, landing charges and miscellaneous charges (Fig.6.7).

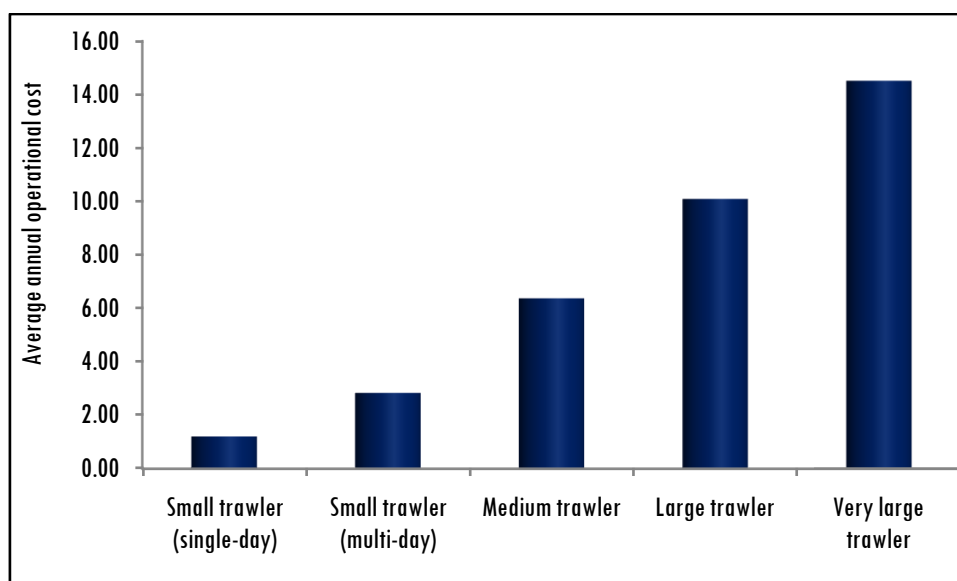

Fig.6.6 Average annual operational cost of mechanised trawlers in Kerala

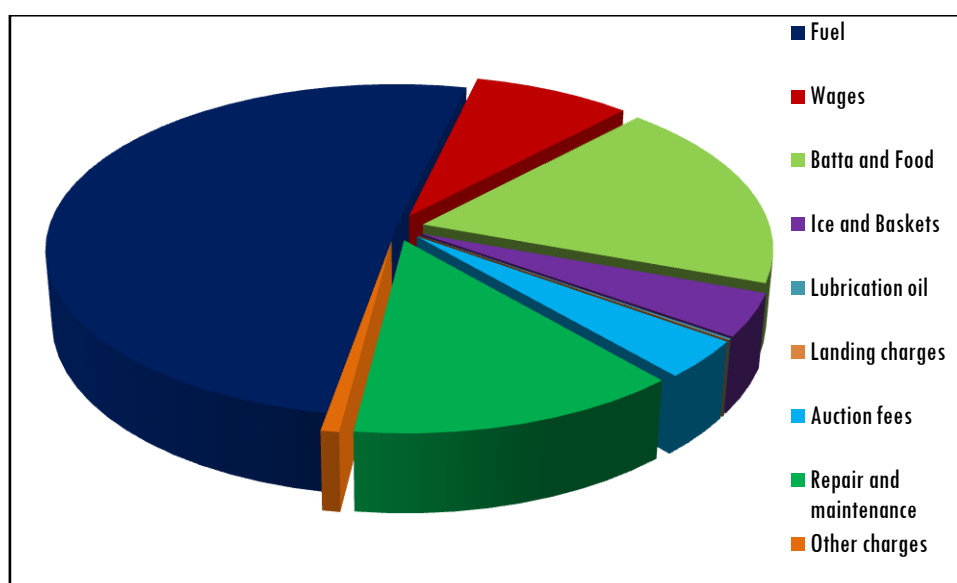

Fig.6.7 Contribution of components to the operational cost

6.3.3.1 Fuel cost

Fuel cost is the major component in the operational cost of mechanised trawlers. Fuel cost varied among different length class of trawlers depending

on rate of fuel consumption and fishing time. Average annual fuel cost of trawlers is 0.6 million rupees in small trawler (single-day), 1.56 million rupees in small trawler (multi-day), 3.1 million rupees in medium trawlers, 4.79 million rupees in large trawlers and 7.79 million rupees in very large trawlers (Fig.6.8). FAO (2007) has reported the greater role of fuel in fishing expenses in developing countries. In many fisheries around the world like purse seine and gillnetting, fuel cost is the second largest contributor to the operational cost after wages to crew (Lam *et al.*, 2011). But in case of trawlers fuel cost accounted a major portion in operational expense higher than wages. It also recognised as a major concern in the economic viability of fisheries and fishing community (Abernethy *et al.*, 2010).

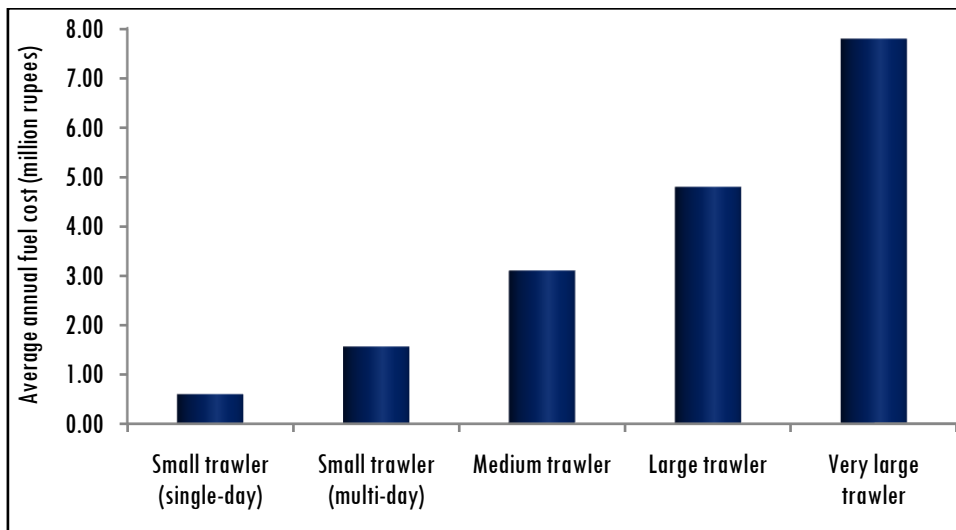

Fig.6.8 Average annual fuel cost of mechanised trawlers in Kerala

6.3.3.2 Fishermen share

Fishermen share is the second largest contributor to the operational cost of mechanised trawlers in Kerala with a share of 27%. Components included in the fishermen share are wages, daily allowance and cost of food. The expense of mechanised trawlers in the form of fishermen share varied from

0.13 million rupees to 3.93 million rupees depending on the length overall of trawlers (Table 6.3 & Fig.6.9). Wages to fishermen varied from 5 to 10% of the revenue in various regions of the state during different periods. On an average annual cost incurred for wages to fishermen is 0.069 million rupees in small trawlers (single-day), 0.25 million rupees in small trawlers (multi-day), 0.64 million rupees in medium trawlers, 0.99 million rupees in large trawlers and 1.1 million rupees in very large trawlers. Cost incurred for daily allowance and food for fishermen contributes a considerable amount to the operational cost of trawlers. On an average, expense of mechanised trawlers in the state towards fishermen share in a year is 0.58 million rupees in small trawlers (single-day), 0.73 million rupees in small trawlers (multi-day), 1.1 million rupees in medium trawlers, 2.56 million rupees in large trawlers and 2.83 million rupees in very large trawlers.

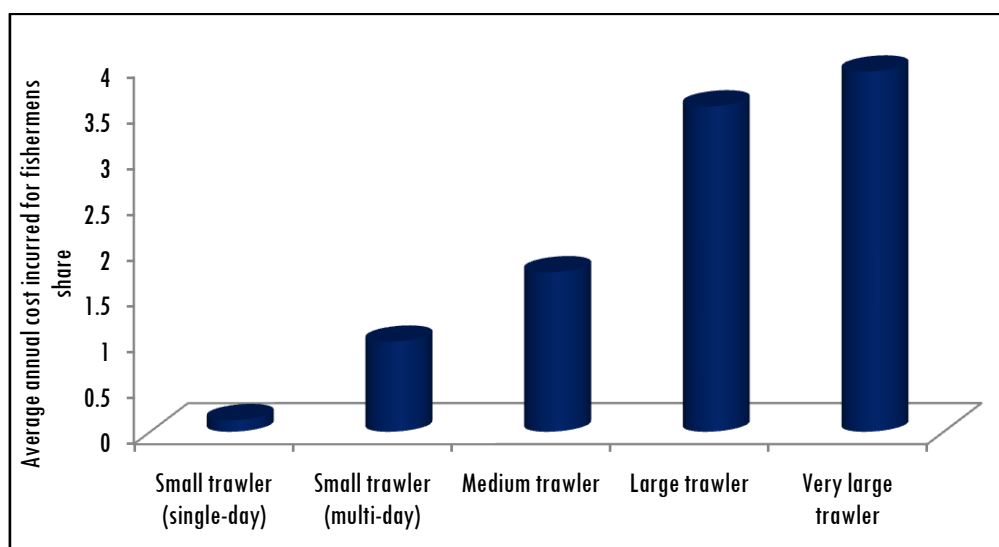

Fig.6.9 Average annual cost of trawlers incurred for fishermen wages

6.3.3.3 Repair and maintenance cost

Repair and maintenance cost is the third largest contributor to the operational cost of trawlers after cost of fuel and fishermen share. It is the cost

incurred for repair and maintenance of trawler, engine and trawl nets. Average repair and maintenance cost of mechanised trawlers in Kerala in a year is 0.38 million rupees in small trawlers (single-day), 0.16 million rupees in small trawlers (multi-day), 0.89 million rupees in medium trawlers, 0.61 million rupees in large trawlers and 1.4 million rupees in very large trawlers (Fig.6.10).

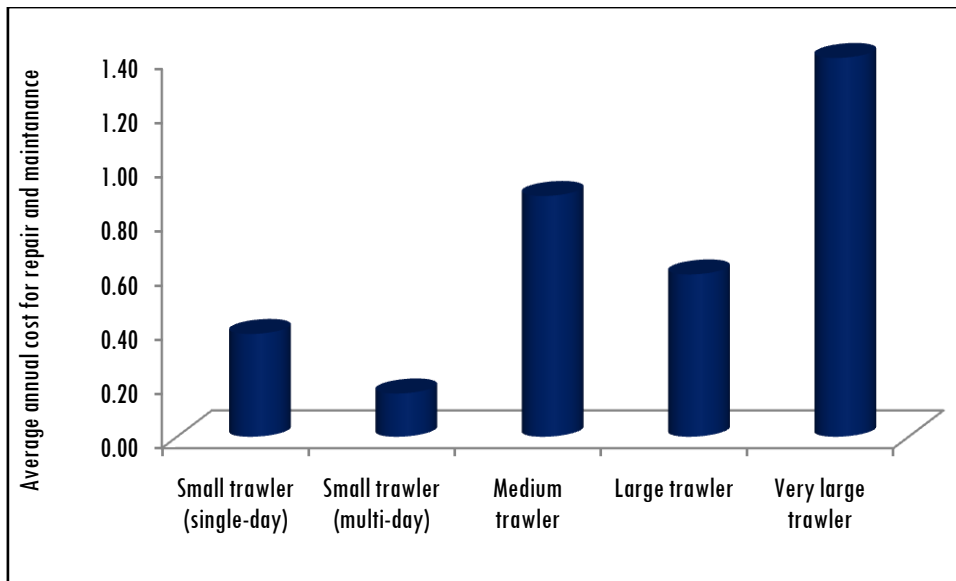

Fig.6.10 Average annual cost incurred for repair and maintenance of trawler, engine and trawl nets of mechanised trawlers in Kerala

6.3.3.4 Cost of ice and baskets, lubrication oil, landing charges, auction charge and miscellaneous costs

Cost of ice and baskets, lubrication oil, landing charges, auction charge and miscellaneous costs altogether constitutes 8.76% of operational cost of trawlers. Total cost incurred for all these elements together is 0.099 million rupees in small trawlers (single-day), 1.36 million rupees in small trawlers (multi-day), 6.55 million rupees in medium trawlers, 1.17 million rupees in large trawlers and 1.31 million rupees in very large trawlers (Table 6.3 & Fig.6.11).

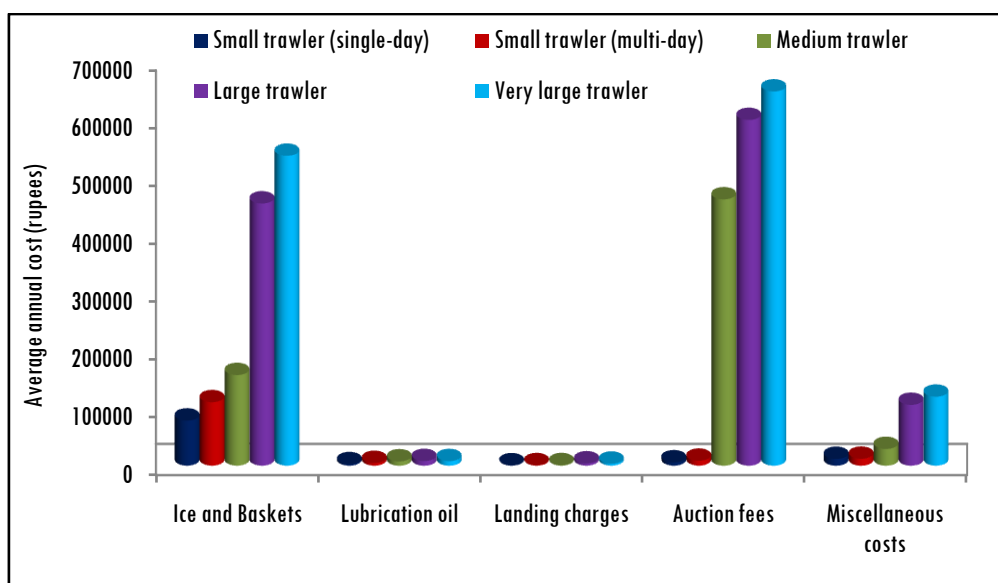

Fig.6.11 Average annual expenses incurred for ice, baskets, lubrication oil, landing charges, auction fee and other miscellaneous cost in mechanised trawlers in Kerala

Table 6.3 Average annual operational cost of mechanised trawlers in Kerala

Items	Small trawler (single-day)	Small trawler (multi-day)	Medium trawler	Large trawler	Very large trawler
Fuel (₹)	604691	1563981	3100266	4785103	7794430
Wages (₹)	69200	252637	637304	986978	1101832
Daily allowance and Food (₹)	57750	732640	1099070	2561268	2831362
Ice and Baskets (₹)	78100	109795	156840	453820	536305
Lubrication oil (₹)	2560	4660	7370	7984	7844
Landing charges (₹)	580	785	820	3965	3456
Auction fees (₹)	5700	8550	460875	598266	647585
Repair and maintenance (₹)	380000	159000	887250	601360	1482300
Other charges (₹)	11700	11920	28870	105206	119340
Total (₹)	1210281	2843968	6378665	10103949	14524454

6.3.4 Total annual cost

Total annual cost of trawlers is the sum of fixed cost and operational cost for one year. It ranged from 1.5 to 17.02 million rupees in mechanised trawlers of Kerala (Table 6.4 & Fig.6.12). In trawlers, share of operational cost in total annual cost is very high compared to fixed cost and it ranged between 73 and 85% (Table 6.5 & Fig.6.12).

Table 6.4 Total annual cost of mechanised trawlers in Kerala

Type of trawler	Operational cost (₹)
Small trawler (single-day)	1513531
Small trawler (multi-day)	3865718
Medium trawler	7916682
Large trawler	12493452
Very large trawler	17024346

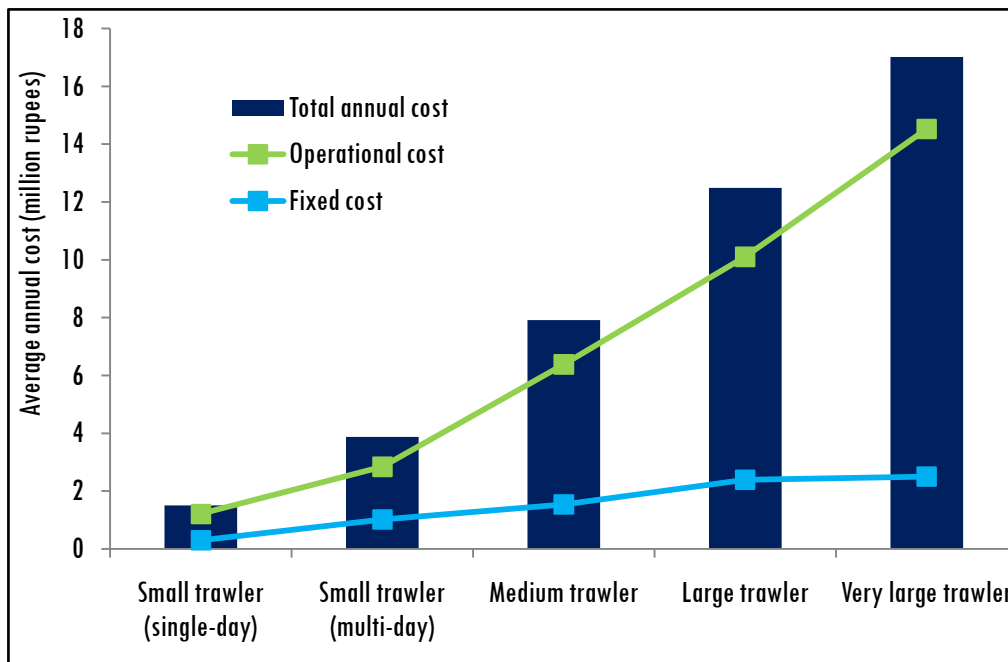

Fig.6.12 Contribution of fixed cost and operational cost to total annual cost of mechanised trawlers in Kerala

6.3.5 Economic efficiency indices

Economic efficiency indices are the measures which determine life of any activity including fishing. The indices were estimated for different length class of trawlers; indices used are gross profit (net operating income), net profit, rate of return on investment, profitability ratio, net profit ratio, operating ratio and payback period which were used by Unnithan *et al.* (1985), Aswathy *et al.* (2011), Xavier (2013) and Shanis (2014). Kalawar *et al.* (1985) analysed time series data for the period from 1971-1982 using estimated cost data and earnings of the trawl fishery found out that profitability of the trawl fishery of Kerala is declining since 1980.

6.3.5.1 Gross profit (Net operating income)

Gross profit is defined as the difference between revenue and variable cost. It is calculated by deducting the operational cost from revenue of a fixed duration (Panayotou & Jetanavanich, 1987). Annual gross profit of mechanised trawlers in Kerala is 0.85 million rupees in small trawlers (single-day), 1.59 million rupees in small trawlers (multi-day), 5.2 million rupees in medium trawlers, 6.61 million rupees in large trawlers and 6.82 million rupees in very large trawlers (Table 6.5).

6.3.5.2 Net profit

A condition where total cost is not met by revenue makes the trawling operation non-profitable and it do not ensure long life for trawlers. Running of a trawler will be terminated when economic life of current assets are finished or when attains an acceptable re-sale value for the assets. Hence in this scenario net profit is more significant than gross profit as it consider the depreciation cost also. By definition net profit is the difference between revenue and total cost of a trawler. From the calculations, average annual net

profit of trawlers is found 0.54 million rupees in small trawlers (single-day), 0.56 million rupees in small trawlers (multi-day), 3.67 million rupees in medium trawlers, 4.22 million rupees in large trawlers and 4.32 million rupees in very large trawlers (Table 6.5). Devaraj & Smita (1988) reported annual net profit of trawlers as 537500 rupees in 1976 and 5805 rupees in 1982; growth occurred in fleet size of mechanised trawlers from 769 per day in 1979 to 3500 per day in 1980 was the reason behind this drastic reduction.

6.3.5.3 Rate of return on investment (RRI)

Rate of return is a common measure to find out the profitability of any economic activity. It is the net profit attained per unit of capital investment. In case of fishing sector especially in trawlers, RRI is less significant as the operational cost is very higher. The rate of return on investment of mechanised trawlers in Kerala is 1.19 in small trawlers (single-day), 0.38 in small trawlers (multi-day), 0.49 in medium trawlers, 0.33 in large trawlers and 0.31 very large trawlers (Table 6.5). Hence single-day trawlers are found to be economical while considering rate of return on investment as capital investment is comparatively less.

6.3.5.4 Profitability ratio

Profitability ratio is the net profit earned per unit of operational cost incurred. It is purely depending on operational cost and in case of trawlers profitability ratio has more significance. Profitability ratio of mechanised trawlers in Kerala is 0.45 in small trawlers (single-day), 0.20 in small trawlers (multi-day), 0.58 in medium trawlers, 0.42 in large trawlers and 0.30 in very large trawlers (Table 6.5). Accordingly medium trawlers found to be more

economic followed by small trawlers (single-day), large trawlers, very large trawlers and small trawlers (multi-day).

6.3.5.5 Net profit ratio

Net profit ratio is the net profit earned from a unit of revenue. It is an indication of profitability in association with total cost of trawlers. In Kerala net profit ratio is higher for medium trawlers (0.32) followed by small trawlers (single-day) (0.26), large trawlers (0.25), very large trawlers (0.20) and small trawlers (multi-day) (0.13) (Table 6.5).

6.3.5.6 Operating ratio

Operating ratio is the indication of operating cost incurred to attain unit revenue. Among the mechanised trawlers in Kerala it is found to be higher for very large trawlers (0.68) followed by small trawlers (multi-day) (0.64), large trawlers (0.60), small trawlers (single-day) (0.59) and medium trawlers (0.55) (Table 6.5). While considering operating ratio medium trawlers found to more economical in the present scenario of Kerala.

6.3.5.7 Payback period

Payback period is the time required to cover the investment cost by earning or to break-even. In mechanised trawlers of Kerala, least payback period is required for small trawlers (single-day) (0.84 years) followed by medium trawlers (2.03 years), small trawlers (multi-day) (2.63 years), large trawlers (3.04 years) and very large trawlers (3.18 years) (Table 6.5).

Table 6.5 Average economic efficiency indices of mechanised trawlers in Kerala

Type of trawler	Gross profit (₹)	Net profit (₹)	Rate of return	Profitability ratio	Net profit ratio	Operating ratio	Payback period
Small trawler (single-day)	846519	543269	1.19	0.45	0.26	0.59	0.84
Small trawler (multi-day)	1585032	563282	0.38	0.20	0.13	0.64	2.63
Medium trawler	5206335	3668318	0.49	0.58	0.32	0.55	2.03
Large trawler	6614051	4224547	0.33	0.42	0.25	0.60	3.04
Very large trawler	6821346	4321454	0.31	0.30	0.20	0.68	3.18

6.3.6 Role of fuel cost in operational cost and revenue of mechanised trawlers

Trawls being the most energy intensive fishing method, the fuel cost forms the major component in operational expenditure of trawlers. The study conducted among 40 selected trawlers of Cochin and Munambam harbours is also delineating the same trend. On an average fuel cost found to be the single largest contributor forming 51% of operational expenditure of mechanised trawlers in the state. Considering the percentage share of fuel according to the size of trawlers, percentage share of fuel cost in operational cost is 52% in small trawlers (single-day), 55% in small trawlers (multi-day), 44% in medium trawlers, 47% in large trawlers and 54% in very large trawlers (Table

6.6 & Fig.6.13). Contribution of fuel cost to the operational expenditure of single-day trawlers is lower due to reduced fuel consumption.

Fuel accounted between 3 and 51% among the factors of operational cost of different fisheries in Australia (Parker *et al.*, 2015). For most fisheries fuel price has a vital role in fuel cost than rate of fuel consumption (Parker *et al.*, 2015), but here in Kerala trawl fishery, the role of fuel consumption rate is significantly higher when compared to fuel price. It was evident from previous studies on the similar aspect. Even when the fuel price was comparatively less, the percentage contribution of fuel cost to operational cost was higher (Kurien & Willmann, 1982; Sehara & Kanakkan, 1992; Sehara & Kanakkan, 1993; Panikar *et al.*, 1991 and Aswathy *et al.*, 2011). Aswathy *et al.* (2011) reported that in small trawlers with L_{OA} 8.5 to 9.5 m, fuel cost contributed 47.9% of operational expenditure in Kerala during 2007, when the engine power of these trawlers was only 90 hp.

In Kerala, share of fuel cost in operational cost was 42.2% in mechanised trawlers during 1992-93 (Sehara & Kanakkan, 1993) which was 47% in 1991 (Sehara & Kanakkan, 1992) and 52% during 1989-90 (Panikar *et al.*, 1991). According to Sehara & Kanakkan (1992), fuel cost formed 42.2% in operational cost of trawlers in Kerala and Shibu (1999) also reported the major contribution of fuel cost to the operational cost of trawlers in Kerala. According to the data collected during 1992-93 from Tuticorin of Tamil Nadu, fuel cost formed major share in operating cost, 46.95% which has been raised to 53.14% during 1997-98 period (Senthilathiban *et al.*, 1997 & 1999). From the data it is understood that the dominance of fuel cost in operational cost of trawlers is an age old fact. During 1990-91, a study conducted in Nagapatinam

of Tamil Nadu, showed that fuel cost is 37.78% of operational cost of trawlers (Sathiadas *et al.*, 1992). In Andhra Pradesh, fuel cost formed 58.88% of operational cost of trawlers during 1982-83 (Gopal *et al.*, 2008). In trawlers of Goa, percentage share of fuel cost in operational cost of trawlers was estimated as 55.79% during 1991-92 (Sehara *et al.*, 1994). A study conducted at Ratnagiri, the contribution of fuel cost to the operational expenditure was 67.20 to 63.35% in different category of trawlers (Kunjir *et al.*, 2007). During 1987-88 period in trawlers operated along Saurashtra coast, fuel cost formed 46.89% of operational cost.

Share of fuel cost in total cost is an indicator to measure the ratio between fuel cost and the total cost in a year. Contribution of fuel cost in the total annual cost of mechanised trawlers in Kerala ranged from 38 to 45%. It is 40% in small trawlers (single-day), 40.46% in small trawlers (multi-day), 39.16% in medium trawlers, 38.3% in large trawlers and 45.78% in very large trawlers (Table 6.6 & Fig.6.13). The results are in accordance with the findings of Cheilari *et al.* (2013), Sumaila *et al.* (2010), Sumaila *et al.* (2007), Dahou *et al.* (2001), Reddy (2004) and FERM (2004). Cheilari *et al.* (2013) assessed the share of fuel cost in total cost of European Union fishing fleets between 17 and 29% in different fishing methods in various years from 2002 to 2008. Sumaila *et al.* (2010) studied among the fisheries of Hongkong and stated that it reached up to a factor of 60%. A study conducted in trawl sector of Nigeria showed that 80.5 to 81.9% of operational cost is contributed by fuel cost (Effiong *et al.*, 2016).

As profitability of fishing varies with different factors such as vessel, gear, engine, operational factors, etc. increased fuel consumption together with

hike in fuel price will heavily affect the profitability of fishing. Cheilari *et al.* (2013) estimated 33% reduction in profitability of EU fishing fleets since 2002 due to above mentioned factors.

One of the most significant aspect to assess the impact of fuel cost in operational profitability of trawlers is to find out the share of revenue expended for fuel cost. At present in Kerala, 26 to 37% of the revenue is spent for fuel in mechanised trawlers. In small trawler (single-day) it is 29.4%, in small trawler (multi-day) it is 35.31%, in medium trawlers it is 26.76%, in large trawlers it is 28.62% and in very large trawlers it is 36.52% (Table 6.6 & Fig.6.13). The findings can be supported by the studies of Kurien & Willmann (1982) and Schau *et al.* (2009). According to Kurien & Willmann (1982), half of the revenue is consumed by the fuel cost in trawlers of Kerala. Schau *et al.* (2009) found out from the data acquired from Norwegian Directorate of Fishing and concluded that in shrimp trawling 34.9% of the revenue is going towards purchase of fuel. Cheilari *et al.* (2013) assessed the fuel cost of European Union fishing fleet and stated that from the revenue, 9.8 to 46% is going towards fuel cost in trawl fishery of various regions.

Table 6.6 Percentage share of fuel cost in operational cost, total cost and revenue of mechanised trawlers

Type of trawler	Percentage share of fuel cost in		
	Operational cost	Total cost	Revenue
Small trawlers (Single-day)	50	39.95	29.40
Small trawler (multi-day)	55	40.46	35.31
Medium trawler	49	39.16	26.76
Large trawler	47	38.3	28.62
Very large trawler	54	45.78	36.52

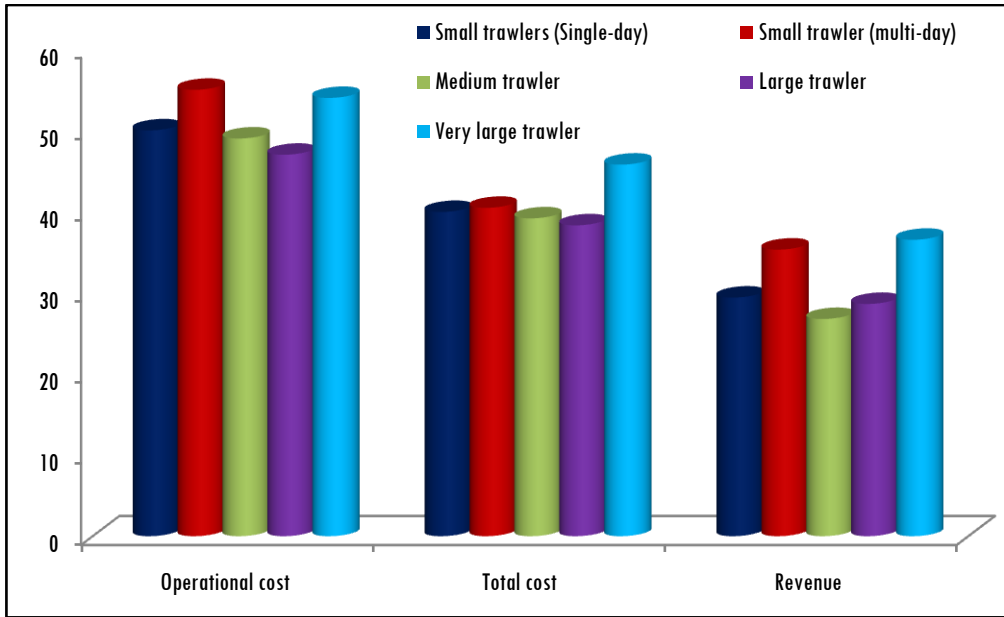

Fig.6.13 Percentage share of fuel cost to the operational cost, total cost and revenue of mechanised trawlers

6.4 Conclusion

Economic viability or economic efficiency is equally an important aspect in fishing industry in addition to technical efficiency. Even if a fishing unit is technically efficient but economically not viable, it is not considered suitable for long running. Reduction in fleet size of mechanised trawlers since 2000 might be associated with the decreased economic viability of trawl units which would be resulted in termination of the units. Economic performance of trawlers in Kerala and a comparison of different length class of trawlers is conducted. Through the study, it is proved that the cost incurred for fixed assets and operation is in linear relationship with the size of trawler. The capital investment of mechanised trawlers in Kerala found to be ranged from 0.45 to 13.74 million rupees. Comparing the capital investment of wooden and steel trawlers, cost of vessel is the major contributor in steel vessels but in wooden trawlers, cost of the vessel is contributing less compared to trawl nets and accessories. Annual fixed cost of

mechanised trawlers in Kerala ranged from 0.3 to 2.5 million rupees. It depends on the fixed assets and is higher in large and very large trawlers and decreasing with respect to size of trawler. The contribution of trawlers towards insurance found to be negligible as Matsyafed is giving insurance to fishing vessels at a very low cost ranging from 250 to 350 rupees depending on the size of trawler. Operational cost, which is the most significant economic factor in case of trawlers found increasing with size of mechanised trawlers depending on the rate of fuel consumption. Annual operational cost of trawlers in Kerala ranged from 1.21 to 14.52 million rupees. Among the components of operational cost, fuel cost found to be major contributor followed by fishermen share, repair and maintenance cost and other remaining costs. Operational cost found to be the major contributor in total annual cost of mechanised trawlers contributing 73 to 85% depending on the size. Profit of trawlers is also in accordance with the size of trawlers; gross profit (net operating income) ranged from 0.85 to 6.82 million rupees and net profit ranged from 0.54 to 4.32 million rupees. By analysing the economic efficiency indices, medium trawlers found to be performing well regarding profitability ratio, net profit ratio and operating ratio. It is followed by small trawlers (single-day) which is better in rate of return on investment and payback period. Small trawlers (multi-day) and very large trawlers found to be performing poor in economic efficiency. Comparing single-day and multi-day trawlers, single-day trawlers found to be economically efficient. Analysis of role of fuel cost in operational cost and revenue of trawlers, it is found that fuel cost contributes 47 to 55% to the operational cost and 38 to 46% to the total annual cost. Generally, 26 to 37% of the revenue is accounted for the cost of fuel in mechanised trawlers of Kerala.



INVESTIGATIONS ON ENERGY CONSERVATION IN TRAWLING - POTENTIAL OF LOW DRAG TRAWL IN FUEL CONSUMPTION AND FISH CAPTURING

7.1 Introduction

Rational and irrational use of non-renewable energy resources will lead to depletion of the resources which will end up in hike in fuel price. As in the case of any other sectors, many of the world's fisheries are facing multiple challenges in the form of over capacity, resource depletion and high investment and rising fuel price will worsen these challenges. Trawl fishery all over the world comprise fuel intensive enterprises and currently stressed economically by rising fuel cost. Trawls are the most energy intensive fishing system consuming more fuel than purse seining, longlining, gillnetting etc. (Gulbrandson, 1986; Tyedmers *et al.*, 2005; Muir, 2015; Parker & Tyedmers, 2014 and Parker *et al.*, 2015). Hence most potential for fuel conservation among fishing techniques exists in trawling. Options to improve the fuel performance of any fisheries will also assure multiple objectives by providing low-carbon fish products, improved economic vulnerability and decreased pressure on over fished resources. A meaningful remedy is to improve energy efficiency by raising productivity per amount of fuel used or reduce fuel cost per amount of fish landed.

There are several ways to improve energy efficiency in trawlers, but most of them will negatively impact yield or capturing efficiency. A solution for this is reducing the drag of trawl net or usage of more efficient propulsion system which will reduce fuel use in short term without affecting the yield (Montgomerie, 2009). During calm weather conditions, majority of fuel is contributed to overcome the trawl drag compared to vessel propulsion in trawlers. In trawling operation, a sizeable time is spent for towing the gear and 10-20% fuel consumed is spent to overcome the resistance (drag) during towing time. Hence it is understood that gear has a large effect on fuel consumption during towing because drag due to vessel is insignificant at the time of towing when compared to drag due to gear (Boopendranath, 2002). Hence a considerable reduction in drag of trawl net will make opportunity for a substantial reduction in fuel consumption of trawlers.

Studies on drag and its influencing factors will be helpful to those who are associated with trawl design to effectively accommodate the design and operational parameters for fuel conservation. Drag is the single most factor influencing in fuel consumption and thereby energy efficiency and profitability of trawl fishing operations which depends on many factors such as design and rigging of net and operating conditions. Sum of drag of each components accounts for total drag experienced by a trawl gear. According to Wileman (1984), warp contributes 5%, sweeps 4%, otterboards 20%, floats 3%, foot rope 10% and netting contributes 58% to total drag of a trawl.

Drag of a trawl gear can be reduced in various ways including reduction in size of net, wing end spread, headline height, twine surface area and ground contact friction. Reduction in twine surface area can be attained either by large meshes or using thinner twines for trawl fabrication. Among these drag reduction potential of large mesh has been studied by several

experts since 1970s (Fujishi, 1985; Fiorentini & Cosimi (1987); Sumpton *et al.*, 1989; Vijayan *et al.*, 1992; Nayak & Seshappa, 1993; Broadhurst *et al.*, 2000 and Balash, 2012). While reducing twine thickness it is to be ensured that webbing is able to provide same strength as that of thicker twines. Webbing made with ultra high molecular weight polyethylene (UHMWPE) material, an advanced form of polyethylene deliver superior strength and performance over conventional polyethylene webbing which is proved to be the most suitable material for trawl net fabrication (Lowe, 1996; Sendlak *et al.*, 2001; Sala *et al.*, 2008; Balash *et al.*, 2009; Anon, 2009; Hansen & Tørring, 2012; Balash, 2012). In this chapter a comparison of drag, fuel consumption and capturing efficiency of UHMWPE and HDPE trawls are depicted. From the data collected during the experiment, the impact of towing speed on drag and impact of drag on fuel consumption were also assessed and described.

7.2 Materials and methods

The study was conducted through experimental fishing trials conducted using two trawl nets of 24.0 m head rope length, one is fabricated with HDPE webbing and second with UHMWPE webbing which are the same reported in Remesan *et al.* (2017). The trials were conducted from ICAR-CIFT Departmental vessel, Matsyakumari II during February to April, 2017. Details of the research vessel and trawl nets used for the experiment are given in section 2.3.1 and 2.3.2. A total of 80 hauls, 40 hauls for each net was conducted and data on towing speed, warp length, depth of operation, drag, fuel consumption and catch were recorded. Depth of operation ranged from 10 to 15 m, during the experimental operations. Towing speed of the vessel varied from 2.3 to 4 kn. Length of warp released varied from 40 to 100 m according to the depth of the ground. Methodology and other details of the

experiment and data collection has been explained in section 2.3.4. Impact of operational parameters on drag of trawl nets is assessed by multiple regression analysis where operational parameters such as depth of operation, warp length and towing speed were taken as independent variables and drag of was taken as dependant variable.

Rigging of trawl nets

Trawl nets were fabricated, rigged and kept ready for operation onboard research vessel. The accessories and ropes used for both the nets were similar which include head rope, foot rope, floats, sinkers, otterboards, warp and bridles. Head rope, foot rope and sinkers were already attached after fabrication of the trawls and floats, otterboards, bridles and warp were attached just before operation. Rope used for head rope and foot rope were PP rope of 12 mm diameter. Sinker used were lead cylindrical sinkers of 200g weight measuring 45 mm in length and 20 mm inner diameter and total weight of sinkers used was 16 kg. Five numbers of Acrylonitrile Butadiene Styrene (ABS) floats of 300 mm diameter were used during entire operation. Sheer devices used were suberkub otterboards of 65 kg weight. Bridles used were PP ropes of 16 mm diameter 20 m length throughout the operation. UHMWPE rope of 12 mm diameter was used for warp.

7.3 Results and discussion

Results of the experiment conducted for evaluation of efficiency of low drag trawl is depicted. Even though aim of the experiment was to study the efficiency of low drag trawl, from the data generated impact of operational parameters on drag and impact of drag on fuel consumption are also estimated. Hence results of the chapter are divided into two sections; 1. Study on drag

with emphasis on operational parameters and fuel consumption and 2. Evaluation of efficiency of low drag trawl.

7.3.1 Study on drag with emphasis on operational parameters and fuel consumption

7.3.1.1 Impact of operational parameters on drag of trawl nets

Operational parameters of a trawler such as towing speed, depth of fishing ground and length of warp released are recorded for each haul. The data generated were analysed and derived the relationship of these factors with drag of trawl net. As these factors were varying randomly in each haul, hence the analysis was carried out using multiple regression analysis. There are several factors influencing drag of trawl nets viz., mesh size, twine size, design and weight of otterboards, floats and sinkers, depth of operation, towing speed, area of operation, etc. As design of net, accessories used and other conditions except depth, warp length and towing speed were similar during entire operation, the effect of operational parameters which were varying throughout the operation were estimated.

Data generated through the experiment were analysed using multiple regression analysis separately for HDPE trawl (Table 7.1) and UHMWPE trawl (Table 7.2). Parameters such as depth of operation, length of warp released and towing speed of the vessel were the major factors considered for analysis. All operational factors are found to have a linear relationship with drag. Among the parameters tested, depth of operation kept with least variation ranging only from 10 to 15 m as it will strongly affect the drag. The average drag of trawl nets at different depth of operation was given in Table 7.3 and Fig.7.1.

Table 7.1 ANOVA table of drag and its affecting factors in HDPE trawl using in the experiment

	Unstandardized Coefficients		Standardized Coefficients	t	Sig.
	B	Std. Error	Beta		
(Constant)	-19.677	9.644		-2.04	0.081
Towing speed	10.108	3.344	0.983	3.023	0.019
Warp length	-0.027	0.064	-0.138	-0.42	0.687
Depth	0.091	0.293	0.063	0.309	0.766

Table 7.2 ANOVA table of drag and its affecting factors in UHMWPE trawl using in the experiment

	Unstandardized Coefficients		Standardized Coefficients	t	Sig.
	B	Std. Error	Beta		
(Constant)	-24.665	6.085		-4.053	0.007
Towing speed	9.276	1.773	0.87	5.232	0.002
Warp length	0.017	0.03	0.096	0.571	0.589
Depth	0.279	0.34	0.122	0.819	0.444

Table 7.3 Average drag of trawl nets in the experiment at different depths

Depth (m)	Average drag (kN)
9.5-10	13.69
10.1-10.5	12.05
10.6-11	13.54
11.1-11.5	15.02
11.6-12	14.92
12.1-12.5	15.21
12.6-13	14.06
13.1-14	11.54
14.1-14.5	14.69
14.6-15	14.54

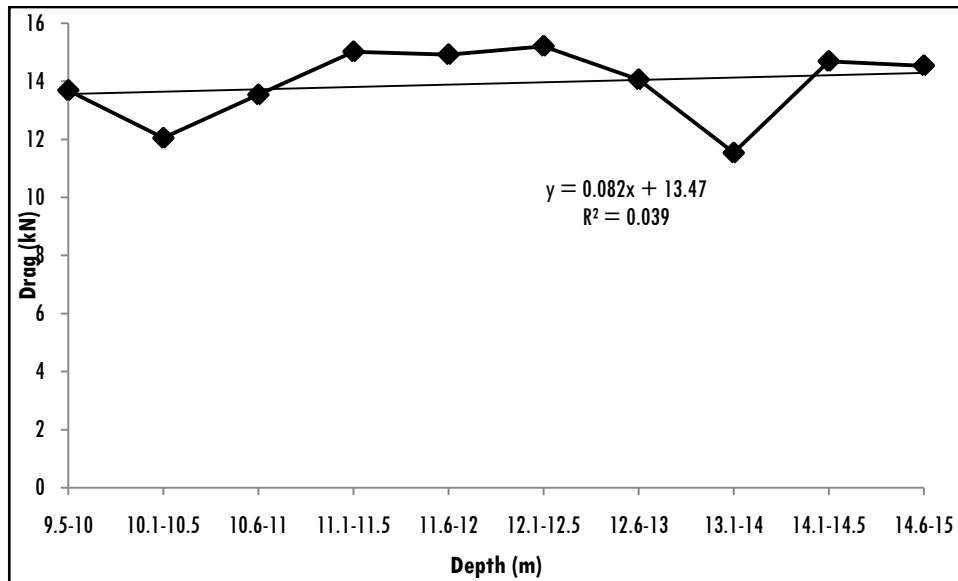

Fig.7.1 Average drag (kN) of trawl nets in the experiment at different depths (m) and its standard error

Length of warp released during entire operation ranged from 40 to 100 m. In the analysis, warp length showed a positive impact on drag which indicates that increased warp length will result in increased drag, but statistically no significant effect was obtained which may be due to the short range of values. Average drag of trawl nets at different warp length is given in Table 7.4. Plotting the average drag at different warp lengths (Fig.7.2) also proved the impact of warp length on drag ($R^2 = 0.59$).

Table 7.4 Average drag of trawl in the experiment at different warp lengths

Warp Length (m)	Drag (kN)
40	9.445
50	12.89
60	13.52
70	13.4
80	13.37
90	15.285
100	13.775

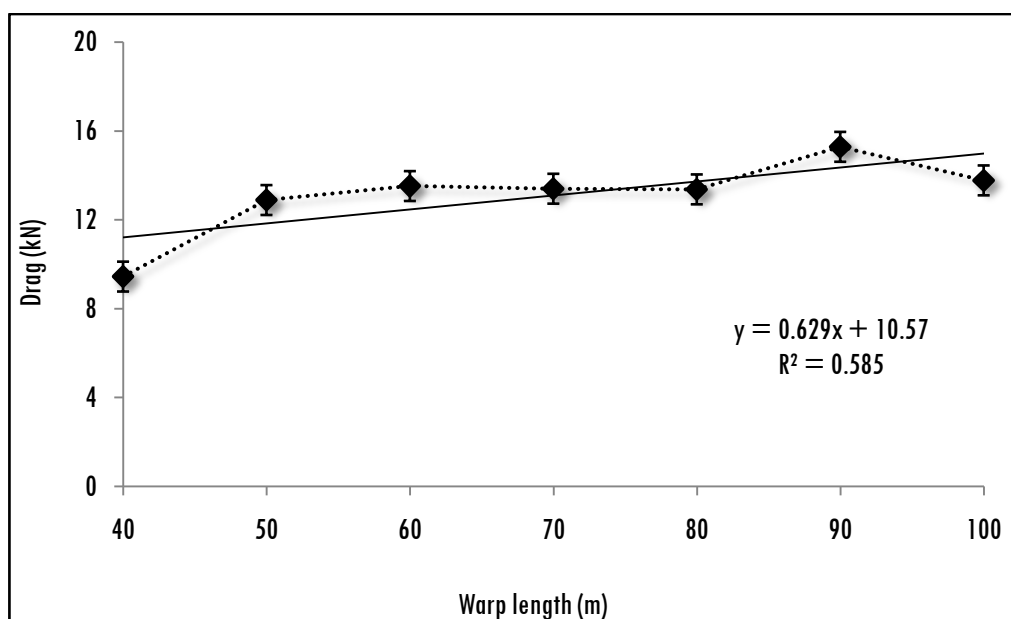

Fig.7.2 Average drag of trawl nets in the experiment at different warp lengths and its standard error

Towing speed is found to be a decisive factor determining the drag of trawl nets and fuel consumption of trawlers. Towing speed of commercial trawlers found to be ranging from 2.0 to 6 kn depending on the target species and type of trawl nets operated. From this range most commonly used was selected for operation and it ranged from 2.3 to 4.0 kn. From regression analysis, the impact of towing speed on drag of trawl nets is established even within the short range of values which is statistically significant for both trawl nets; $p < 0.019$ for HDPE trawl and $p < 0.002$ for UHMWPE trawl. From the ANOVA table it is observed that every 9.28% increase in towing speed made 1% increase in drag of UHMWPE trawl and 10.11% increase in towing speed made 1% increase in drag of HDPE trawl. Average drag at every towing speed is plotted (Table 7.5 & Fig.7.3) and from the graph, the impact of towing speed on drag of trawl nets is very much clear ($R^2 = 0.805$).

Impact of towing speed on drag of trawl nets is a well established fact, but studies on the aspect rare and at the same time effect of towing speed on fuel consumption had been well studied. As drag of trawl nets and fuel consumption of trawlers are linearly related, they can be used to explain and support the impact of towing speed on drag. However results of the present study are in accordance with the studies conducted by BIM (2009) where effect of speed on fuel consumption has been assessed and found that decrease in one nautical mile speed will be resulting up to 70% savings on fuel due to reduced drag. Balash & Sterling (2012) tested model trawl nets fabricated with different materials (24ply 400 den PE, Ultracross Dyneema®, Hampidjan Dynex, Hampidjan Dynex T90 and Ultra cross dyneema) in flume tank and significant increase in drag with increase in towing speed was observed in all materials. Sala *et al.* (2011) assessed energy performance of fishing vessels under different operating conditions and 15% reduction in fuel consumption was obtained by reducing half a knot speed. Studies conducted by Priour (1999), Khaled & Priour (2010) and Khaled *et al.* (2013) also throw light on impact of towing speed on fuel consumption of trawlers. Reduced towing speed is strongly recommended to reduce drag, because it is found to have no effect on catch and yield. Madhu & Panda (2009) studied the effect of tow duration and towing speed on capture efficiency of bottom trawl and concluded that towing speed have no impact on capturing efficiency of trawls. Manjarres-Martinez *et al.* (2015) investigated the effect of mesh size and towing speed on the multispecies catch rates of historical swept area surveys during 1988-2001 in Colombian Carribean sea and found that towing speed doesn't have significant impact on catch rate.

Table 7.5 Average drag obtained at different towing speed for trawl nets used for the experiment

Speed (kn)	Total Tension (kN)
2.3	9.74
2.4	9.78
2.5	9.8
3	11.03
3.1	12.21
3.2	13.31
3.3	13.41
3.4	13.3
3.5	13.72
3.6	14.47
3.7	13.45
3.8	14.07
3.9	14.1
4	14.11

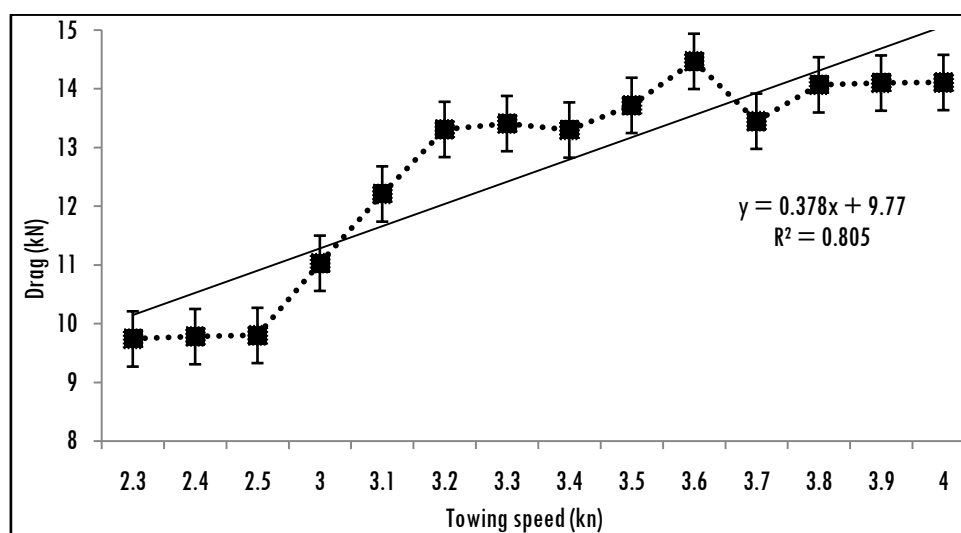

Fig.7.3 Graph showing change in drag (kN) of trawl nets with respect to change in towing speed (kn) of trawler and its standard error

7.3.1.2 Impact of drag on fuel consumption of trawlers

Drag, being the single most factor affecting fuel consumption of trawlers, investigations on energy conservation in trawls can begin through establishing the relationship between drag and fuel consumption. During the experiment, drag and fuel consumption of each haul were recorded and average fuel consumption at every point of drag is estimated (Fig.7.4). From the ANOVA table it is evident that 1.94% decrease in drag of HDPE trawl (Table 7.6) and 2.17% decrease in drag of UHMWPE trawl (Table 7.7) made 1.0% decrease in fuel consumption. Average fuel consumption at different values of drag obtained is given in Table 7.8 and Fig.7.4.

Factors which affect the fuel consumption of fishing boats are the design and nature of hull, propeller, age of vessel, design and weight of gear and speed of vessel. The target catch, nature of fishing ground and depth of operation also affect the fuel consumption of fishing vessels. Studies related to energy efficiency in trawling through gear modification stresses the significance of low drag trawls, but a quantification of relationship between drag and fuel consumption is lacking. Linear relationship between drag and fuel consumption had been explained by Fiorentini *et al.* (1981), Priour (2009), Khaled & Priour (2010) and Khaled *et al.* (2013). Drag had been identified as a single most factor influencing the fuel consumption of trawlers severely and at a maximum of 40% improvement in fuel consumption of trawlers is reported by making considerable reduction in drag through modification of gear design parameters (Hansen & Tørring, 2012). Roy Gibbons from Fisheries and Marine Institute of Memorial University of Newfoundland in one of his presentations described reduction in drag of trawl net as a way to reduce fuel usage in trawlers based on Fiorentini *et al.* (1981) in which it is reported that drag due to vessel is 15-20% of the gear drag. Khaled & Priour (2010) suggested drag reduction as a measure to energy conservation in trawlers.

Table 7.6 ANOVA table on impact of drag on fuel consumption of trawler using HDPE trawl in the experiment

	Unstandardized Coefficients		Standardized Coefficients	t	Sig.
		Std. Error	Beta		
(Constant)	5.753	2.561		2.246	0.051
Drag	1.939	0.173	0.966	11.182	0

Table 7.7 ANOVA table on impact of drag on fuel consumption of trawler using UHMWPE trawl in the experiment

	Unstandardized Coefficients		Standardized Coefficients	t	Sig.
		Std. Error	Beta		
(Constant)	4.339	3.834		1.132	0.291
Drag	2.168	0.348	0.911	6.229	0

Table 7.8 Average fuel consumption of trawler at different levels of drag

Drag (kN)	Fuel consumption (l)
7-8	20
8-9	20
9-10	20
10-11	21.5
11-12	23.4
12-13	25
13-14	32.5
14-15	36.6
16-17	37.5
17-18	40
18-19	40

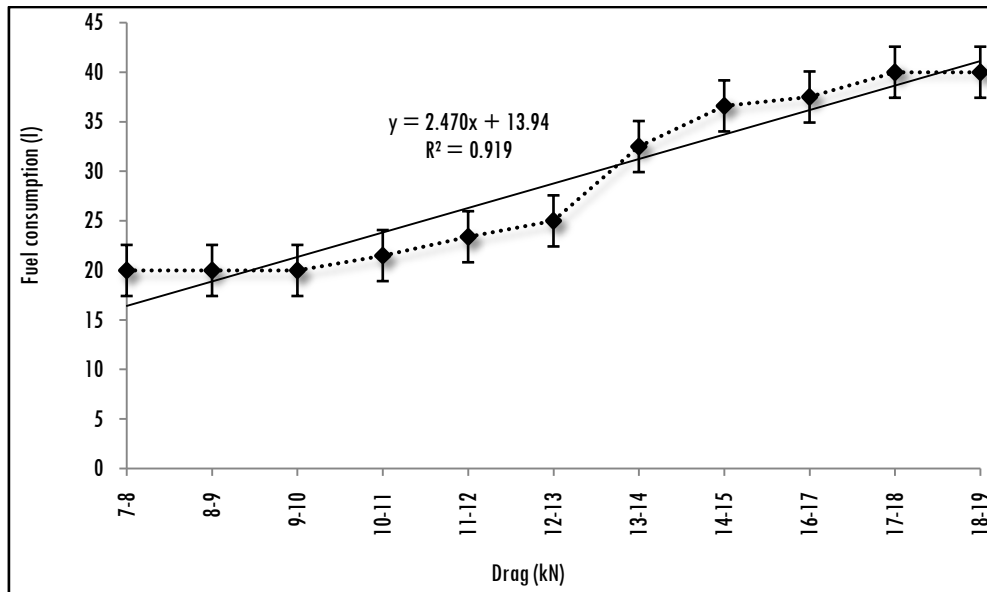

Fig.7.4 Change in drag and fuel consumption of trawl nets

7.3.2 Efficiency of low drag trawl

Increased fuel consumption per kilogram of fish landed and increasing price of fuel entail the energy conservation efforts in trawling sector. According to FRDC (2007) rising fuel cost, impending oil deficit and global concern for reduction of green house gas emission necessitate improvements in energy efficiency technologies. Evaluation of low drag trawls were done through fishing trials conducted from research vessel, R. V. Matsyakumari II using trawl fabricated with UHMWPE webbing of thinner twines and a control net fabricated with HDPE webbing. Twine size of UHMWPE webbings corresponding to twine size of HDPE webbing was selected based on the data provided by Garware Wall Ropes Limited (GWRL), Pune on the properties of the UHMWPE materials of their brand (Table 7.9). Strength of UHMWPE as that of thicker twines of conventional material has already been proved. Lowe (1996) compared drag saving potential of UHMWPE netting with polyethylene netting for prawn trawls and result showed that 49% thinner

UHMWPE gives similar breaking strength of usual polyethylene netting. In the present study, both nets were operated at a set of pre-fixed operational parameters; bathymetry was 10 to 15 m, length of warp released was 40 to 100 m and towing speed varied from 3 to 4 kn. Designs of low drag trawl (UHMWPE trawl) and conventional HDPE trawl is same as that of described by Remesan *et al.* (2017) which is given in Fig.2.5 and Fig. 2.6 in chapter 2. UHMWPE material have more strength than conventional materials and its elasticity is very low (Hansen & Tørring, 2012). Hence it allows the use of thinner twines than traditional webbing materials which help in reducing the drag.

Table 7.9 Data from GWRL showing twine size of UHMWPE webbing corresponding to PE twines (Source: GWRL, Pune)

Twine size (mm)	Runnage (m/kg)	Breaking strength (kgf)	Remark
1	2640	79	Equal to 2.0 mm PE
1.2	1770	116	Equal to 2.5 mm PE
0.75	5220	36	Equal to 1.25 mm PE
0.85	3428	52	Equal to 1.5 mm PE

7.3.2.1 Reduction in drag

Reduction in twine thickness will benefit in reduced twine surface area which will in turn reduce the drag of trawl nets. Twine surface area (TSA) calculated following Ferro (1981) for both the nets are given in table 7.10. From the estimated TSA, drag of both nets were calculated using the formula proposed by Reid (1977) which is based on the formula given by McLennan (1973). From the estimated drag of webbing, total drag of trawl system has been calculated based on the assumption that 58% of the total drag is constituted by webbing (Wileman, 1984). Arithmetic studies showed that there

is 79% reduction in drag while using UHMWPE webbing instead of HDPE webbing (Table 7.10)

Table 7.10 Empirically estimated twine surface area and drag of trawl nets used for experiment

	TSA	Drag (kN)
UHMWPE	6.45	4.35
HDPE	11.58	7.81

Drag of trawl nets during experiment was measured as warp tension, tension exerted on the warps. Tension on both warps were measured using warp tension meter at five minutes interval during entire towing time and sum of the tension at both warps is taken as drag of the trawl nets and analysed. Average value of drag obtained during a single haul which is taken at five minutes interval is considered as the drag of particular haul. Average drag obtained from 40 hauls is taken and it is 13.33 ± 2.51 kN for HDPE trawl and 8.52 ± 2.46 kN for UHMWPE trawl (Fig.7.5). That is on an average UHMWPE trawl showed 36% less drag than conventional HDPE trawl. As drag may change at different operational parameters, drag of both nets at different levels of towing speed, depth and length of warp were evaluated. Fig.7.6 to Fig.7.8 show the drag of nets at different towing speed, depth and warp length through which superiority of UHMWPE trawl at all operational conditions is proved. Application of UHMWPE webbing results in use of less netting material for a given size of fishing gear, hence the potential for reduction in drag exists. The drag of trawl nets were tested using ‘t’ test and proved that the difference is significant ($p < 0.003$).

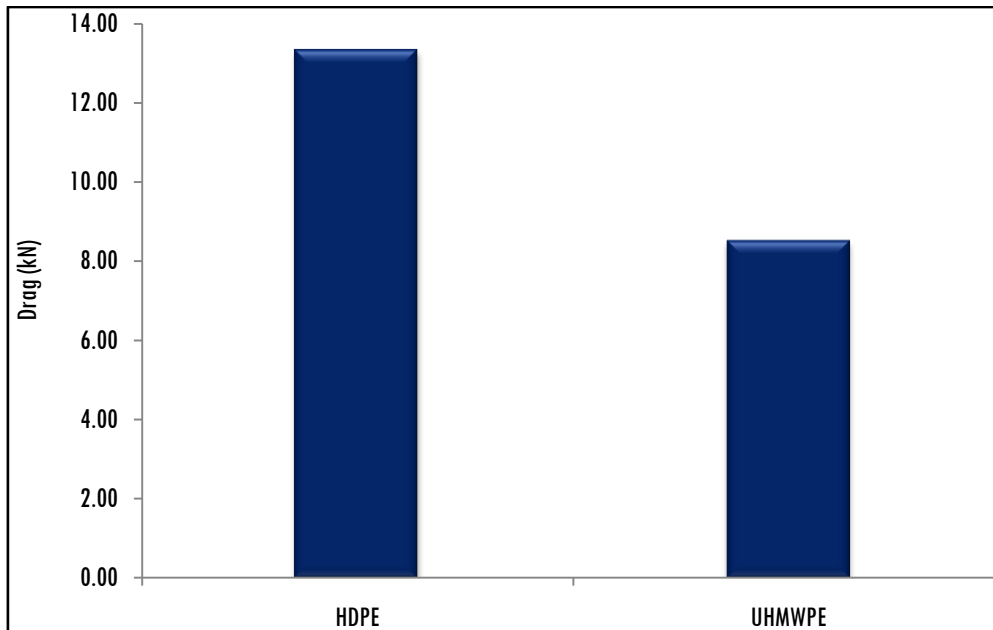

Fig.7.5 Average drag of HDPE and UHMWPE trawl in experiment

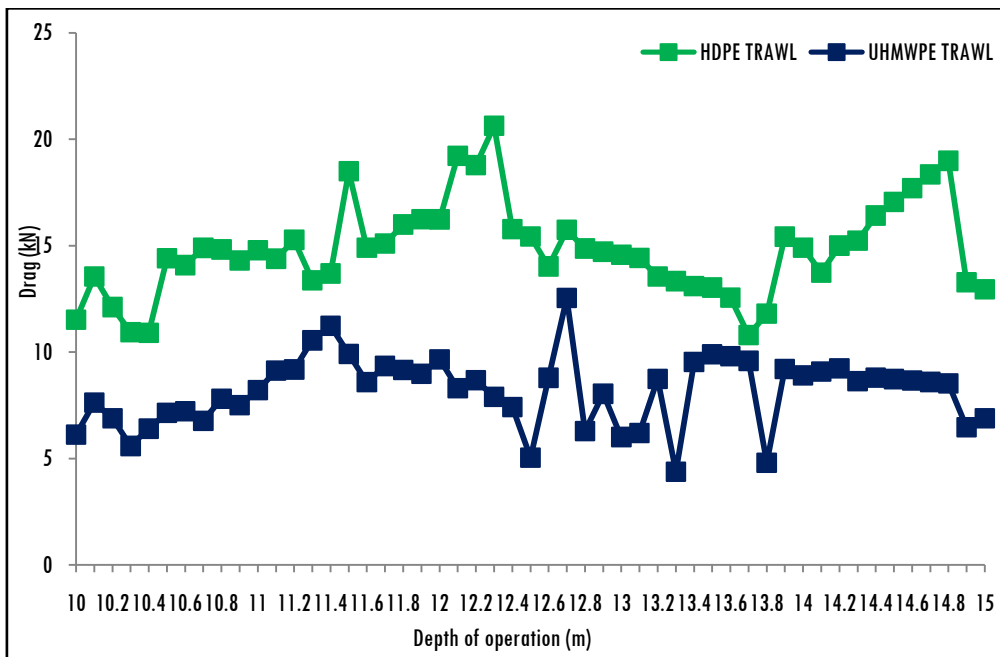

Fig. 7.6 Average drag of trawl nets different depth of operation

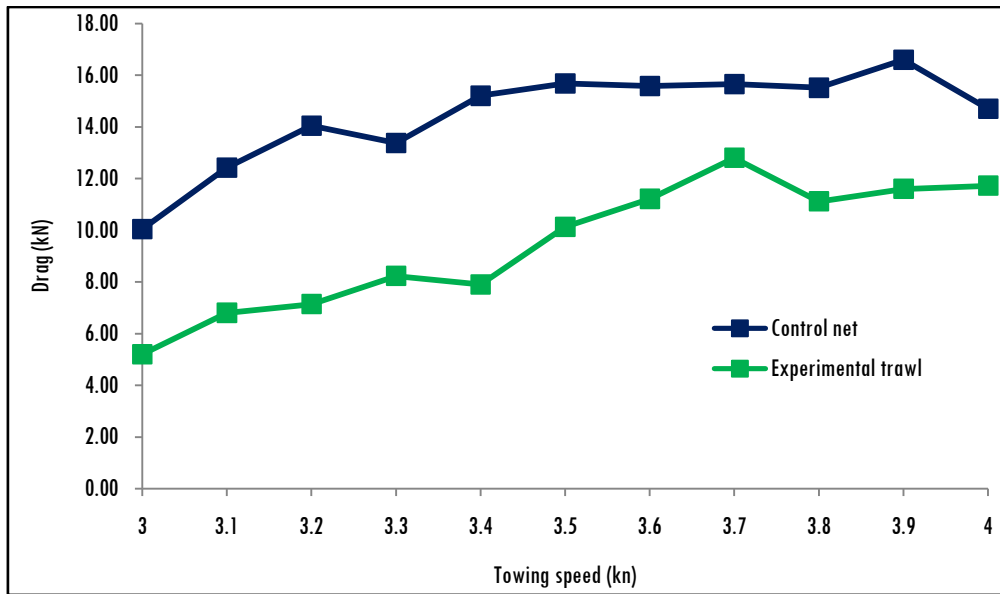

Fig.7.7 Average drag of HDPE and UHMWPE trawls at different towing speed

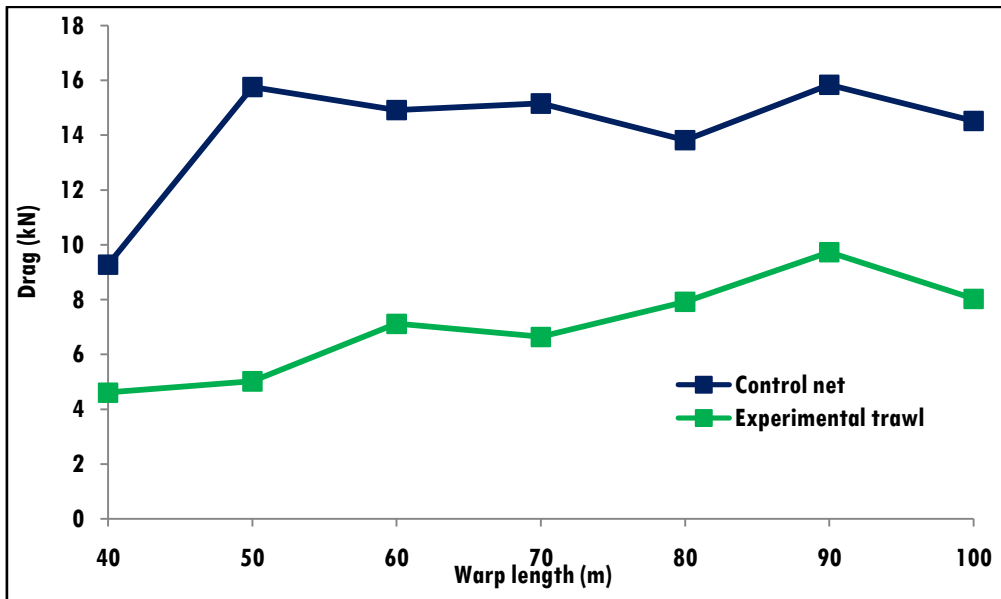

Fig.7.8 Average drag of HDPE and UHMWPE trawls at different warp lengths

Findings of the experiment and analysis on potential of UHMWPE trawl in reducing drag is in accordance with the results of Parente *et al.*

(2008), Wileman (1984), Lowe (1996), Tait (2001), Montgomerie (2009) and Balash & Sterling (2012 & 2014). Efficiency gain of trawls resulted from usage of UHMWPE webbing allows increase in towing speed which will be benefited to cover more area within the same time or use of larger nets at same engine power. Potential savings in time from bringing navigational speed close to critical speed were overshadowed by the advantages of navigating at a higher speed and getting more time for towing which results in increased yield (Parente *et al.*, 2008). Wileman (1984) estimated benefits of using thinner twines through an experiment based on Nordic trawl designs and estimated 7% reduction in drag by using thinner twines. Tait (2001) also described the benefits in using thinner twines in which 8.3% savings in drag was obtained by simple reduction of twine size. Montgomerie (2009) conducted sea fishing trials to compare conventional PE and UHMWPE trawls and reached to a conclusion that 9-17% reduction in drag can be attained at different operational parameters by using UHMWPE webbing. Balash & Sterling (2012) tested model trawl nets made of different materials in flume tank and proved that UHMWPE showed least drag compared to all other materials. Balash & Sterling (2014) presented the study conducted among Australian fishermen on energy efficiency and found out that 40% reduction in twine size, facilitated by the use of UHMWPE twines made 22% reduction in drag. Broadhurst *et al.* (2015) increased lateral mesh opening in shrimp trawls and obtained 9-12% decline in drag. Hansen & Tørring (2012) used 1.4 mm UHMWPE webbing in the entire trawl except codend and assured that drag has been reduced. The reason for not to use UHMWPE in codend is, its contribution to drag is marginal and thicker larger twine gives a larger spreading effect and strength to codend. Hansen & Tørring (2012) used Dyneema warps and they stated that the profitability of bottom trawling

improved by 40%. Balash *et al.* (2009) also studied the drag of plane netting material and similar tendency was observed.

7.3.2.2 Reduction in fuel consumption

Most significant approach in evaluation of efficiency of low drag trawl is reduction in fuel consumption. Fuel consumption of trawlers are heavily affected by drag of trawl nets as 10-20% of fuel is consumed to overcome the resistance (drag) of trawl nets (Montgomerie, 2009). Fuel consumption of trawlers during the experiment was measured using fuel flow meter and by sounding table with the help of engine crew. Fuel consumption of each hauls and fuel consumption per day were estimated. But as navigation phase averages about only 24% time of fishing trip of a trawler, fuel consumed during navigation period will be very less compared to towing period (Parente *et al.*, 2008). Hence towing time emerges as the most important phase for fuel conservation efforts.

Average fuel consumption of each hauls were estimated and analysis revealed that HDPE trawls consumed 31.86 ± 12.55 litres of fuel per hour of towing time whereas it is only 25.31 ± 13.84 litres for UHMWPE trawls (Fig.7.9). The study proved that substituting the HDPE trawls with low drag trawls made of UHMWPE, 20% fuel savings can be achieved. More trials in various conditions are required to arrive at the exact quantity. As fuel efficiency in fish capturing or fuel use intensity is the indicator of efficiency of fishing gears (Tyedmer *et al.*, 2005), it is also estimated for both the nets. It is usually expressed as fuel used to capture one kilogram of fish, it is 2.9 litres in HDPE trawls and 2.1 litres in UHMWPE trawls (Fig.7.9). Hence by comparing the fuel use intensity of UHMWPE trawl with HDPE trawl, 34% savings in fuel can be obtained through use of UHMWPE material. Difference in fuel consumption of trawl nets is tested statistically using 't' test and proved significant ($P < 0.005$).

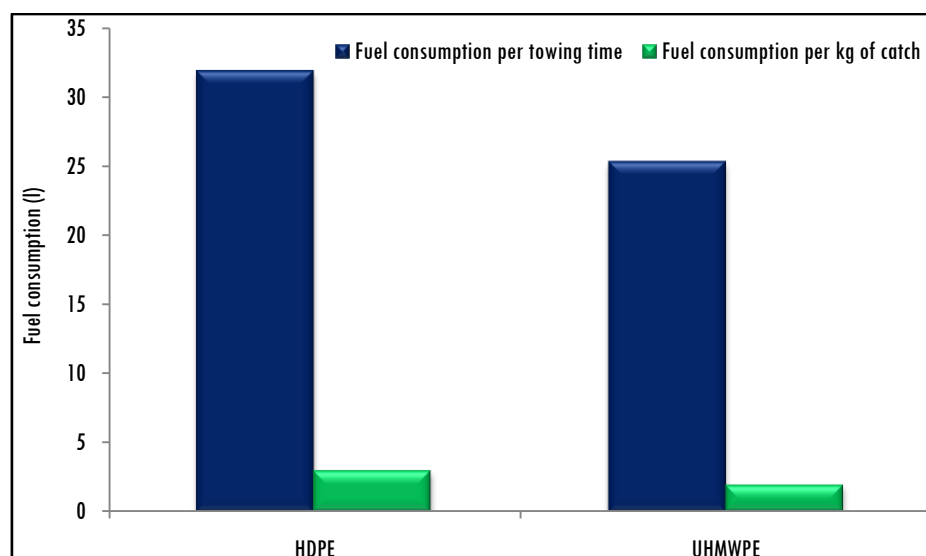

Fig.7.9 Fuel consumption of UHMWPE and HDPE trawls in experiment

Trawl net made of UHMWPE webbing provided 20% reduction in fuel consumption which is in accordance with the previous studies (Fiorentini *et al.*, 1981; Priour, 2009; Khaled & Priour, 2010; Parente *et al.*, 2008; Khaled *et al.*, 2013 and Broadhurst *et al.*, 2015). Depth of operation kept almost constant during the trials as it will strongly affect drag (Grimaldo *et al.*, 2015 and Eayrs *et al.*, 2012) and fuel consumption of trawlers.

Hansen & Tørring (2012) reported 40% reduction in fuel consumption of trawlers by making considerable reduction in drag of trawl nets. A small change in drag of trawl nets, which is due to steeper cutting at the wing and bellies and adoption of increased mesh size provided 18% saving in fuel use (Parente *et al.*, 2008). Khaled & Priour (2010) suggested drag reduction as a measure to energy conservation in trawlers. Khaled *et al.* (2013) predicted fuel conservation nature and catching efficiency of low drag trawls. Broadhurst *et al.* (2015) made investigations on low drag trawls and estimated 4-12% less fuel consumption compared to conventional design. Semi-pelagic trawls and pelagic trawls were found to have lesser fuel consumption than bottom trawls. Grimaldo *et al.* (2015) compared the fuel consumption of pelagic and semi-

pelagic trawls with bottom trawls and found 17% and 5.5% fuel saving respectively. A study conducted in New England Ground Fish fishery, semi-pelagic trawls was proved to consume 12% less fuel compared to bottom trawls (Eayrs *et al.*, 2012).

7.3.2.3 Increased capturing efficiency

Low drag trawls are found to have better capturing efficiency compared to conventional trawls. Capturing efficiency of fishing gears are assessed in terms of catch per unit effort (CPUE). Among various aspects of CPUE, time spent for towing and unit litre of fuel consumed are selected. Catch per unit towing time of UHMWPE trawl is 8.1 kg whereas it is only 7.9 kg in HDPE trawl showing 2.5% improvement (Fig.7.10). Catch per unit litre of fuel consumed is 0.53 kg and 0.34 kg for UHMWPE and HDPE trawl respectively giving 52.6% improvement (Fig.7.10). Hence it is proved that at least 2.5% improvement in CPUE can be obtained in trawl fabricated with UHMWPE trawl compared to conventional HDPE trawl. However difference in CPUE of both trawls are statistically not significant, $p < 0.063$.

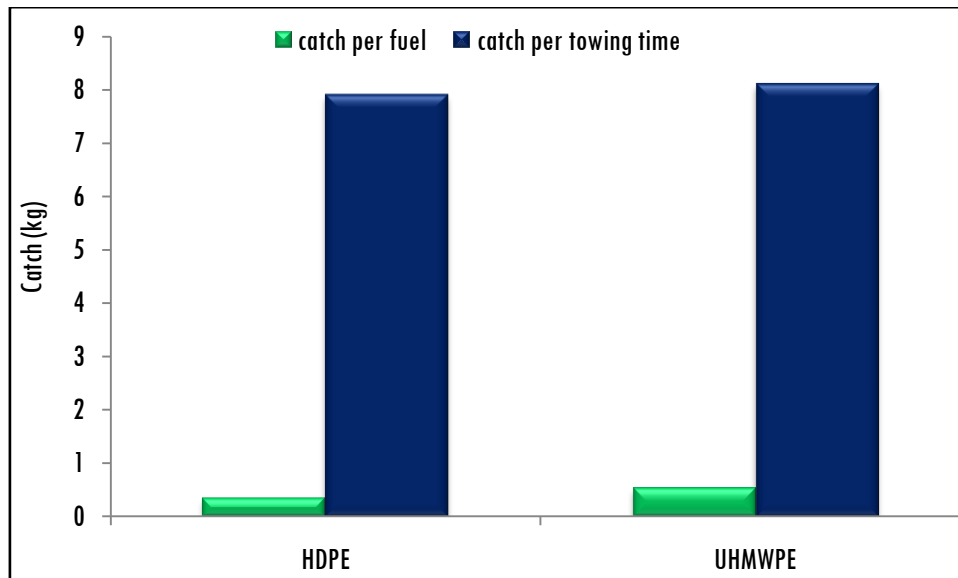

Fig.7.10 Catch per unit effort of HDPE and UHMWPE trawls in experiment

Improvement in CPUE of low drag trawls can be explained by the slightly higher mouth area, UHMWPE trawls are presented to have higher vertical mouth opening compared to horizontal mouth opening which was evident from underwater studies (Parente *et al.*, 2008). Seafish compared efficiency of trawls made of UHMWPE webbing with traditional HDPE trawls and found to have 40-56% greater mouth opening when towed at similar speed (Montgemorie, 2009). These alterations in trawl geometry is advantageous to attain higher speed which will in turn increase efficiency of trawlers in capturing small pelagic and fast swimming fishes as well as demersal resources. A case study conducted by Khaled *et al.* (2013) predicted that low drag trawls reduce the ratio between drag and catch efficiency up to 46% which would enable reduction in fuel consumption per fish captured. Tait (2001) tested the efficiency of low drag trawl in which thinner twines were used and the results had proven 42.9% increase in catch per unit hour and catch per unit litre of fuel consumed.

7.4 Conclusion

Nature is endowed with rich energy resources, however rational and irrational use results in gradual reduction in non-renewable energy resources which will lead to global energy crisis. This fact has reached all over the world and as a result most of the countries are pledged to low carbon future. Besides the problem of resource depletion, irrational use of non-renewable energy has become concerns of environmental pollution as well as less profitability. All these compel to modify the energy strategies and seek new measures to solve energy issues or its future scarcity to be occurring in fossil fuels and fuel price hike have raised the necessity of energy efficiency in all sectors.

By analyzing the impact of operational parameters on drag of trawl nets, positive effect of depth of operation, length of warp and towing speed on drag of trawl nets have been proved. Among these factors, effect of towing speed on drag of trawl nets is quantified, through which it is concluded that 10.1% decrease in towing speed of HDPE trawl and 9.28% decrease in towing speed of UHMWPE trawl will impact 1% reduction in drag of trawl nets. The linear relationship between drag and fuel consumption is established and it showed that 1.94% decrease in drag of HDPE trawl and 2.17% decrease in drag of UHMWPE trawl will make 1% decrease in fuel consumption of trawlers.

Results of the evaluation of low drag trawl designed and fabricated with UHMWPE webbing with thinner twines demonstrated improvement in fuel consumption and capturing efficiency. As the name indicates, the drag and the fuel consumption of low drag trawl was less when compared to conventional HDPE trawl. In UHMWPE trawls, 36% reduction in drag was obtained which resulted in 20% reduction in fuel consumption and a minimum of 2.5% improvement in CPUE was observed.

Plate 3 – Low drag (UHMWPE) trawl



Trawl net



Codend



Sinker attachment



Foot rope and head rope



Rigging in progress

Plate 4 – Different stages of low drag trawl experiment



Tying the codend before operation



Floats attached to the net



Attachment of bridle



Setting the warp



Ready for towing



Warp tension meter attached



Hauling the bridles



Hauling the net



Codend with catch



Catch landed

...१०२...

SUMMARY AND RECOMMENDATIONS

8.1 Summary

Fishing is one of the most significant occupation, source of income and source of food for mankind. It is also a recognised animal protein generator; protein requirement of mankind can be fully met with the enormous fishery resources of world oceans. Most of the problems faced by humans can be connected to energy use in one way or another. Diminishing fuel resources and increasing demand is leading to escalation in fuel price, which is adversely affecting the economic vulnerability of commercial fishing. However in the midst of growing concern for rationalization of fisheries management, conservation of energy, emission of green house gas leading to global warming and climatic change, sectoral conflicts among fishermen and consumer appreciation for low carbon food products, the issue of fuel consumption needs further exploration.

Fuel represents one of the largest cost associated with fishing operation while actual proportion attributed to fuel varies greatly between fisheries. Being the most energy intensive fishing system, all these concerns are at its highest in trawling sector. India being a developing country which relies heavily on fishery for livelihood, employment and foreign exchange earnings the problem in fishery sector has a cascading effect on others. The results of the investigations carried out on trawl fishery of Kerala are presented along with an approach to energy conservation. The content of the thesis is organized into 8 chapters.

First chapter of the thesis includes a general introduction, literature review of the topics covered and rationale and objectives of the study. The objectives set for the study were; to profile the mechanised trawl fishery of Kerala, to investigate the growth in trawl fishery of Kerala, to estimate the fuel consumption of commercial trawlers, to understand the economic performance of mechanised trawlers in Kerala, to study the drag of trawl nets and evaluation of efficiency of low drag trawl.

Second chapter describes the materials and methods adopted for the study. It explains areas covered for the survey, methods adopted for data collection and description of instruments used, research vessel, trawl nets used for experiment, etc.

Third chapter is a profile of mechanised trawl fishery of Kerala in which technical specifications of trawlers, trawl nets and operation are discussed. Methodology adopted for profiling is a survey conducted along the coast line of the state starting from Kasargod to Kollam where more than 80% of the mechanised trawlers are distributed. Trawl fishing fleet of Kerala is constituted by four category of trawlers; small trawlers (20%), medium trawlers (10%), large trawlers (67%) and very large trawlers (3%). One of the major finding is the steep decline in number of small and medium trawlers as fishermen prefer large and very large trawlers with high speed engines for undertaking multiday voyages in deep waters. Majority of trawlers are constructed with steel and conduct multiday fishing throughout the year except during trawl ban period. Single-day trawlers are an exception which are constructed with wood and they operate for seven months from August to February. At present most of the trawlers are coming under the category of large trawlers which are having L_{OA} 16-24 m. Maximum size of the trawler observed during the study is 33.5 m. Large and very large trawlers exclusively

use imported engines with high power. Indian made engines are popular among small trawlers and medium trawlers. Engine power of small trawlers varied from 116 to 350 hp, medium trawlers 240 to 427 hp, large trawlers 350 to 495 hp and very large trawlers 427 to 550 hp.

Four types of trawl nets are popular in the state viz., fish trawls, shrimp trawls, cephalopod trawls and gastropod trawls. Trawl nets are made with machine made HDPE webbing of varying mesh size and twine size. Head rope length of trawl nets varied from 39.0 to 125.0 m and the maximum mesh size observed is 10m. Most common codend mesh size observed is 20-25 mm. 'V' form steel otterboards are most widely used except in small trawlers. Three seasons of fishing exist among mechanised trawlers of the state viz., one is targeting shrimps, second with no specific target and third targeting finfish and operation will be depending on availability of resources.

Fourth chapter is an assessment of temporal growth taken place in mechanised trawl fishery of Kerala. Trawlers are introduced commercially during 1950s in the state since then it became popular. They constitute major portion of total fishing fleet and contribute a major share of total marine fish landings in the state. Since 1980s, 5 times increment in number of trawlers is estimated until 2010 but, since 2000 there has been no significant growth as a result of fishermen's urge to bigger vessels instead of numerous small vessels. Similarly 5 time growth in L_{OA} of trawlers occurred since introduction. Proportionately growth in engine power is also evident and it is estimated as 55 times. Design of trawl nets in the state also showed significant changes. There is 15 times increment in head rope length of trawl nets since introduction. In case of mesh size, shrimp trawls showed six times increment and fish trawls showed a growth over 60 times since 1990s. Significant growth

in depth of operation is also evident, but codend mesh size is showing no significant change which is always kept less than the regulations.

Fifth chapter is fuel consumption, energy efficiency and environmental burdens of mechanised trawlers in Kerala. Data for the study was collected continuously for two years from June, 2014 to May, 2016 from trawlers operated at Cochin and Munambam harbours. Fuel consumption per trip of 40 selected trawlers (10 trawlers from each size class) were collected using pre-tested proforma. Rate of fuel consumption per vessel in terms of fuel consumption per hour, fuel consumption per day, fuel consumption per trip and fuel consumption per year were estimated for different size class of trawlers. In addition to rate of fuel consumption, fuel efficiency, energy requirement, energy intensity and carbon emission of trawlers were also quantified. Rate of fuel consumption is proportional to the length overall of trawlers which ranged from 0.01 to 0.15 million litres per vessel annually. Single-day trawlers consume 57% less fuel compared to multi-day trawlers. Fuel consumption per hour of trawlers ranged from 7.5 to 48.5 litres in various length classes. On an average trawl fishing fleet of Kerala consumed 165.3 million litres of fuel annually during the period of study at an average rate of 0.96 kg per kg of fish landed which ranged from 0.28 to 3.45 kg. Energy required for mechanised trawlers in the state in the form of fossil fuel ranged from 18.4 to 110.43 GJ of energy per vessel in a year exclusively for operation. Energy intensity of mechanised trawlers in the state on an average is estimated to be 36.25 GJ per kilogram of fish landed. Kerala trawl fishery released 0.45 million tonnes of carbon in a year exclusively through fuel use at the rate of 2.24 kg CO₂ per kg of fish landed. Rate of carbon emission is least in very large trawlers (1.87 kg per kg of fish) followed by medium trawlers (1.98 kg per kg of fish), large trawlers (2.6 kg per kg of fish), small trawlers

(single-day) (2.73 kg per kg of fish) and small trawlers (multi-day) (4.03 kg per kg of fish).

Sixth chapter, economic performance of mechanised trawlers in Kerala delineates capital investment, annual expenditures and their economic efficiency. Data were collected through a survey conducted among mechanised trawlers operated in three districts Kollam, Ernakulam and Kozhikode. Centres selected were Neendakara, Sakthikulangara, Cohin, Munambam, Beypore, Puthiyapa and Chombal. Additionally data were also collected from trawlers of Cochin and Munambam harbours which were selected for studying fuel consumption. The study revealed that capital investment for mechanised trawlers in Kerala ranged from 0.45 to 13.74 million rupees. Fixed cost is estimated on annual basis which includes interest on capital, cost of insurance and cost of depreciation. It varied from 0.3 to 2.5 million rupees in different length class of trawlers. Operational cost ranged from 1.21 to 14.52 million and contribution of fuel cost to the operational cost of trawlers ranged from 47 to 55% with an average of 51%. From the revenue, 26 to 37% is spent towards fuel cost. By analyzing the profit very large trawlers found to be efficient, but medium trawlers found efficient while analysing economic efficiency indicators such as profitability ratio, net profit and operating ratio.

Seventh chapter describes the efficiency of low drag trawl in fuel consumption and fish capturing. A low drag trawl was designed by incorporating thinner twines which will be beneficial in reducing twine surface area and drag. To provide the optimum strength, at lower twine size, UHMWPE is selected as suitable material. The evaluation was done through experimental fishing trials conducted from ICAR-CIFT departmental vessel, R. V. Matsyakumari II using two trawl nets of 24.0 m head rope length one fabricated with UHMWPE webbing and the second with HDPE webbing. The

results showed that usage of UHMWPE material is beneficial in reducing 36% drag which will be beneficial to 20% savings in fuel. While reducing fuel consumption, UHMWPE trawl also showed improvement in fish capturing, there was 2.5% increment in catch per unit towing time and 52% increment in catch per unit litre of fuel used. Through the experiment an assessment of impact of operational parameters on drag and impact of drag on fuel consumption of trawlers were also estimated and it is proved that 10.1% decrease in towing speed of HDPE trawl and 9.28% decrease in towing speed of UHMWPE trawl makes 1% decrease in drag and 1.94% reduction in drag of HDPE trawl and 2.17% reduction in drag of UHMWPE trawl make 1% reduction in fuel consumption of trawlers.

Final chapter of the thesis is summary and recommendations in which summary of all chapters and some recommendations based on findings are given.

8.2 Recommendations

1. Number of vessels, their size and engine power need to be optimized for better performance of the sector and also for resource conservation.
2. Size of the trawl net and the mesh size should be legalized as per the recommendations in KMFRA amendments.
3. Self regulation to avoid pair trawling, pelagic trawling and night trawling will be a better option for conflict management.
4. Mini trawling in near shore waters should be avoided to reduce bycatch and discards from the sector.
5. Low drag trawls may be adopted for energy efficiency and reduction of green house gas emission.



REFERENCES

- Aarsnes, J. V., Rudi, H. and Loland, G. (1990) Current forces on cage, net deflection. In: Engineering for offshore fish farming. Proceedings of a conference organised by the Institution of Civil Engineers, Glasgow, UK, 17-18 October 1990. 137-152.
- Abernethy, K. E., Trebilcock, P., Kebede, B., Allison, E. H. and Dulvy, N.K. (2010) Fuelling the decline in UK fishing communities? ICES J. Mar. Sci. 67: 1076-1085.
- Aegisson, G. and Endal, A. (1993) Energy Conservation Programme in Indian Fisheries - Report from the Preparatory Phase, Report No.402009.00.01.93, MARINTEK, Norwegian Marine Technology Research Institute, Trondheim, Norway: 45 p.
- Ali, S. M. (1996) Marine Fisheries Economics and Development in India. A case study of Orissa, M. D. Publications Private Limited.
- Allen, K. R. (1981) Energy inputs and outputs in an Australian coastal whaling operation. Mammals in the Seas. Volume-3. General Papers and Large Cetaceans. Selected Papers of the Scientific Consultation on the Conservation and Management of Marine Mammals and Their Environment. FAO Advisory Comm. of Experts on Marine Resources Research, Rome , 375-377.
- Andeev, N. N. (1962) Handbook of Fishing Gear and its Rigging, Israel Program for Scientific Translations, Jerusalem, 472p.
- Anonymous (1971) The heavy tickler chain — right or wrong? World Fish., 20 (10): 8-10.

- Anonymous (1973) Big mesh trawl experiments. *Fish News. Int*, 12(8): 137-138.
- Anonymous (1974) New bottom trawl has sea trials in Britain. *Fish. News. Int.*,13(9): 59-63.
- Anonymous (1984a) Fisherman's Guide to Better Fuel Economy - based on conclusions from The Oilfish Project 1981-1984 (Nordforsk),Volvo Penta, Gotenberg, Sweden: 31 p.
- Anonymous (1984b) Meeting the challenges of the EEZ - some thoughts on fishing craft technology in India, *Bay of Bengal News* 13:10-11, 24 p.
- Anonymous (1989) Proceedings of the World Symposium on Fishing Gear and Fishing Vessel Design 1988, Marine Institute (The Newfoundland and Labrador Institute of Fisheries and Marine Technology), St. John's, Newfoundland, Canada: 610 p.
- Anonymous (2009) - Trawlers switch to Dyneema® D-Netting, <http://www.worldfishing.net/features101/productlibrary/fish-catching/ trawling/ trawlers-switch-todyneema-d-netting>
- Arkley, K. (2008) Reducing Drag in Towed fishing Gears - Fishing Trials to Evaluate the Performance of a Trawl Constructed from T90 ('turned mesh') Netting. SEAFISH Report SR595, Grimsby 37p.
- Aswathy, N. A., Shanmugam, T. R. and Sathiadhas, R. (2011) Economic viability of mechanized fishing units and socio-economics of fishing ban in Kerala. *Indian Journal of Fisheries*, 58 (2): 115-120.
- Avadi, A. and Freon, P. (2013) Life cycle assessment of fisheries: A review for fisheries scientists and managers, *Fisheries Research* 143: 21-38.

- Bagenal, T. B. (1958) An analysis of the variability associated with the Vigneron-Dahl modifications of the otter trawl by day and by night and a discussion of its action. *J. Cons. perm, int. Explor. Mer*, 24(1): 62-79.
- Bhagirathan, U. (2009) Studies on the Effects of Bottom Trawling on the Benthic Fauna off Veraval Coast, Gujarat. PhD Thesis cochin university of science and technology 245 p.
- Baiju, M.V., Boopendranath, M.R. and Edwin, L. (2012) Need for regulating horsepower race in small-scale mechanised fishing vessels. *Fisheries Policy Update* 8, Central Institute of Fisheries Technology, Cochin, 6 p.
- Bal, D.V. and Rao, K.V. (1984) *Marine Fisheries*, Tata Mc Graw Hill Publishing Co. Ltd., New Delhi, 470p.
- Balash, C., Colbourne, B., Bose, N., and Raman-Nair, W. (2009) Aquaculture net drag force and added mass. *Aquacultural Engineering*, 41 (1): 14-21.
- Balash, C. and Sterling, D. (2012) Prawn Trawl Drag due to Material Properties – An investigation of the potential for drag reduction, Second International Symposium on Fishing Vessel Energy Efficiency E-Fishing, Vigo, Spain, May 2012, 9 p.
- Balash, C. (2012) Prawn trawl shape due to Flexural Rigidity and Hydrodynamic Forces. Ph.D. Thesis submitted to University of Tasmania. 92p.
- Balash, C. and Sterling, D. (2014) Australian prawn-trawling innovations for enhanced energy efficiency, in 3rd International Symposium on Fishing Vessel Energy Efficiency. Vigo, Spain.

- Balash, C., Sterling, D., Binns, J., Thomas, G. and Bose, N. (2015) The effect of mesh orientation on netting drag and its application to innovative prawn trawl design. *Fisheries Research*, 164(0): 206–213.
- Baranov, F.I. 1933. *Commercial Fishing Technique*, Translated from Russian, Israel Programme for Scientific translations, Keter Publishing, Jemsalem, 254p.
- Baranov, F.I. (1960) *Tehnika Promyshlennogo Rybolovstva Fishchepromizdat*.
- Bardach, I.E. (1982) Oil, fish and the sun and the wind, p. 1-14, In: May, RC., Smith, LR. and Thomson, D.B. (Eds.) (1982) *Appropriate Technology for Alternative Energy Sources in Fisheries*, Proceedings of the ADB-ICLARM Workshop on Appropriate Technology for Alternative Energy Sources in Fisheries, Manila, Philippines, 21-24 February, 1981, ICLARM Conf. Proc. 8.
- Barraclouakgh, W. E. and Johnson, W. W. (1956) Further Midwater Trawl Developments in British Columbia, Fisheries Research Board of Canada, Bulletin No. 123, 45 p.
- Beardsley, A. (1973) Design and evaluation of a sampler for measuring the near bottom vertical distribution of pink shrimp (*Pandalus jordani*). *Fish Bull. Natl. Ocean. Atmos. Adm.*, 71(1): 243-253.
- Ben-Yami, M. (1959) Study of the Mediterranean trawl net. In: *Modern fishing gear of the world 2.*, Fishing News (Books) Ltd., London, 1: 213- 221.
- Ben-Yami, M. (1975) Setting doors to save fuel. *World Fishing*, 24(3): 15-30.
- Ben-Yami, M. (1989) Trends in boats motorization in the artisanal fisheries: the cases of Nigeria, Equador and Kenya, Paper 1.3, In: *Proceedings of International Fisheries Energy Optimisation Working Group*

- Meeting, 28-30 August, 1989, University of British Columbia, Vancouver, B.C., Canada.
- Ben-Yami, M. (1993) Scope for low energy fishing in the present world fisheries context, p. 121-125, In: Proceedings of the National Workshop on Low Energy Fishing, Fishery Technology, Special Issue, Society of Fisheries Technologists, Cochin, India.
- Ben-Yami, M. (1994) Some principles concerning the design of purse seines, INFOFISH International 5/94: 61-67.
- Bessonneau, J. S. and Marichal, D. (1998) Study of the dynamics of submerged supple nets. Ocean Engineering 27 (7).
- BIM (2009) Improving fuel efficiency on fishing vessels. BIM User Friendly Guides No. 7, 22p.
[http://www.bim.ie/media/bim/content/publications/Improving,Fuel,Efficiency,on,Fishing,Vessels,\(User,Friendly,Guide\).pdf](http://www.bim.ie/media/bim/content/publications/Improving,Fuel,Efficiency,on,Fishing,Vessels,(User,Friendly,Guide).pdf)
- Bjordal, A. and Lokkeborg, S. (1998) Long lining, Fishing News Books Ltd., Farnham: 208 p.
- Blaxter, L., Parrish, B.B. and Dickson, W. (1964). The importance of vision in the reaction of fish to driftnets and trawls. In: Modern fishing gear of the world 2., Fishing News (Books) Ltd., London, 2: 229- 236.
- Boopendranath, M. R. (2000) Studies on Energy Requirement and Conservation of Selected Fish Harvesting Systems. Ph.D. Thesis. Cochin University of Science and Technology, Cochin, India, 273 p.
- Boopendranath, M. R. (2002) Basic principles of fishing gear design and construction ICAR-Winter School Manual: Advances in Harvest Technology, Publisher: Central Institute of Fisheries Technology,

- Cochin, Editors: Meenakumari B., Boopendranath M. R., Pravin P., Thomas S.N., Edwin L., 258-272.
- Boopendranath, M. R. (2008) Climate change impacts and fishing practices, Paper presented in Workshop on Impact of Climate Change in Fisheries, 15th December 2008, ICAR, New Delhi.
- Boopendranath, M. R. (2012) Waste Minimisation in Fishing Operations, *Fishery Technology* 49: 109 – 119.
- Boopendranath, M. R., Pillai, N. S., Kunjipalu, K. K. and Rao, K. K. (1986) Effect of saikite in improving trawl gear programme. *Fish Technol*, 23(1):45-48.
- Boopendranath, M.R. and Hameed, S.M. (2013) Gross energy requirement in fishing operations. *Fish. Technol.* 50(1), 27-35.
- BP Statistical Review (2017) 66th edition 25p. <https://www.bp.com/content/dam/bp/en/corporate/pdf/energy-economics/statistical-review-2017/bp-statistical-review-of-world-energy-2017-full-report.pdf>
- Brabant, I.C. and Nedekec, C. (1983) Bottom trawls for small-scale fishing: Adoption for pair trawling. *FAO Fish. Tech. Pap.*, (189): 5 -8.
- Brandt, A. V. (1959) Classification of fishing gears. *Modern Fishing Gears of the World I*. Fishing News (Books) Ltd. Surrey, England, 274-296.
- Brandt, A. V. and Klust, G. (1971) Synthetic net materials for bottom and midwater trawls, *Modern Fishing Gear of the World* , p. 318.
- Brandt, A.V. (1972) Fishing with bottom trawls. In: *Fish Catching Methods of the world*, Fishing News (Books) Ltd., Survey, London: 136-143.
- Brandt, A.V. (1984) *Fish Catching Methods of the World*, Fishing News Books Ltd., London: 432 p.

- Brandt, A. V. (2005) *Fish Catching Methods of the World*, Edited by O. Gabriel, K. Lange, E. Dahm and T. Wendt. 4th Ed. Blackwell Publishing Ltd. UK. 523 p.
- Broadhurst, M.K. (2000) Modifications to reduce bycatch in prawn trawls: A review and framework for development. *Rev. Fish. Biol. Fish.* 10, 27–60.
- Broadhurst, M.K., Sterling, D.J. and Millar, R.B. (2015) Traditional v/s novel ground gears: maximising the environmental performance of penaeid trawls. *Fish. Res.* 167, 199–206.
- Buckingham, H. (1972) Design of Trawls. *World Fish.*, 21(11): 55-56.
- Burgess (1964) *Fishing News International*, 3; 351-352.
- Buxton, N.G. and DeAlteris, J.T. (1992) Quantification of water flow and net drag in midwater trawls. *Fish. Res.*, 16: 165-178.
- Carrothers, P. J. G. (1957) *Industrial Memorandum.*, 19, Fisheries Research Board of Canada.
- Catasta, L. (1959) Studies to improve the efficiency of otter boards and trawl floats. In: *Modern Fishing Gear of the World*, Kristjanson, H. (Ed.), Fishing News (Books) Ltd., London, 1: 251-253.
- CECAF (1995) Report of the Ad Hoc Working Group on Economic Aspects of Sardinella and Other Small Scale Species in Northwest Africa. CECAF / PACEser.no.94 / 59.Rome, FAO, 1995.
- Chandrapal, G.D. (1975) A review on the warp depth relationship (scoperatio) in trawl fishing. 7(7): 15 -20.
- Chapman, C.J. (1964) Importance of mechanical stimuli in Fish behaviour, especially to trawls. In: *Modern Fishing Gear of the World*, Fishing News (Books) Ltd., London, 2: 537- 540.

- Charles, W.B.W. (1986) Technical tips from Norway. National Fisherman Year Book, 66(13):60-62.
- Cheilari, A., Guillen, J., Damalas, D. and Barbas, T. (2013) Effects of the fuel price crisis on the energy efficiency and the economic performance of the European Union fishing fleets. Mar. Policy 40, 18-24.
- Chokesanguan, B. (1985) Basic Knowledge of Trawl and Trawling, TD/LN/58, Training Department, SEADEC, Samutprakan: 57 p.
- Choudhury, R.L.R. (1973) Optimum size of fishing vessels for exploitation of near and distant water fisheries around Indian coast, Proc. Symposium on Living Resources of the Seas around India, Central Marine Fisheries Research Institute, Cochin: 716-724.
- CIFT (2003) CIFT-TED for Turtle-safe Trawl Fisheries - A Success Story in Responsible Fisheries), CIFT Special Bulletin No. 12 (English): 40 p.
- CIFT (2011) Central Institute of Fisheries Technology Semi-Pelagic Trawl System: An Ecofriendly Alternative to Bottom Trawling for Small scale Mechanised Sector (Boopendranath, M.R., Remesan, M.P., Pravin, M.P. and Madhu, V.R., Eds). CIFT Technology Advisory Series. Central Institute of Fisheries Technology, Cochin, 16 p.
- Clucas, I.J. (1997) Study of the options for utilization of bycatch and discards from marine capture fisheries. FAO Fisheries circular No-928, Rome, FAO, 59 p.
- CMFRI (1981) All India census of marine fishermen, craft and gear: 1980. Marine Fisheries Information Service; Technical and Extension Series, No. 30: 32p.

- CMFRI (2006) Marine fisheries census 2005 Part-1, Central Marine Fisheries Research Institute, Cochin, 97 p.
- CMFRI *Annual Reports 2007-08 to 2016-17*, CMFRI, Kochi
- CMFRI (2012) Marine Fisheries Census 2010 Part I India, Department of Animal Husbandry, Dairying & Fisheries and CMFRI, 98p.
- CMFRI (2017) Annual Report 2016-17. Central Marine Fisheries Research Institute, Kochi, 292p.
- Crewe, P.R. (1964) Some general engineering principles of trawl gear design. In: *Modern Fishing Gear of the World*, Fishing News (Books) Ltd., London, 2: 165 -181.
- DADF (2016) Handbook on Fisheries Statistics 2011, Department of Animal Husbandry, Dairying and Fisheries, Ministry of Agriculture, Govt. of India, New Delhi, 166 p.
- Dahou, K., Déme, M. and Dioum, A. (2001) Socio-economic and environmental impact of Senegalese fishery support mechanisms. UNEP Fisheries Workshop, Geneva, 12 February 2001, 34p.
- Department of Fisheries (2006), Enumeration of Mechanised Boats and Vessels Operating in Kerala, Thiruvananthapuram.
- Deshpande, S.D. (1960) On the fishing experiments conducted with a 10' beam trawl, *Indian J. Fish.* 7(1): 174-186.
- Deshpande, S.D. and George, N.A. (1965) *Fish. Technol.*, 2(1): 82-86.
- Deshpande, S.D., Rao, S.V.S.R. and Vijayan, V. (1970a) Results of preliminary trials with a 15.8 m six seam otter trawl, *Fish. Technol.* 7(2): 186-189.

- Deshpande, S.D., Sivan, T.M. and Rao, S.V.S.R. (1970b) Results of comparative fishing trials with rectangular flat and rectangular curved otter boards, *Fish. Teehnol.* 7(1): 38-41.
- Deshpande, S.D., Sivan, T.M., Kartha, K.N. and Ramarao, S.V.S. (1972) Comparative catch efficiency studies between two-seam and four-seam otter trawl. *Proc. Indo-Pac. Fish. Counc.*, 13(3) : 444-449.
- Devaraj, M. and Smita, P. (1998) Economic performance of mechanized trawlers in the state of Kerala, India. *Fish. Res.* 6, 271 – 286
- DFID (2004) Linkages between Trade Reforms, Livelihoods and Food Security: A Summary of Key Findings. Policy Briefing. London, DFID.
- Dickson, W. (1979) Trawl drag area and netting geometry, ICES-CM-1979/B: 26p.
- Dickson, W. (1959) Use of model nets as a method of developing trawl gear. In: *Modern Fishing Gear of the World*, Fishing News (Books) Ltd., London, 2. 166-174.
- Digre, H., Hansen, U. J. and Erikson, U. (2010) Effect of trawling with traditional and ‘T90’ trawl codends on fish size and on different quality parameters of cod *Gadus morhua* and haddock *Melanogrammus aeglefinus*. *Fish. Sci.*, 76, 549–559.
- Driscoll, J. and Tyedmers, P. (2010) Fuel use and greenhouse gas emission implications of fisheries: management the case of the New England Atlantic herring fishery. *Marine Policy* 34 (3): 353–359.
- Dutilh, C.E. and Kramer, K.J. (2000) Energy consumption in the food chain. *Ambio*; 29 (2): 98–101.

- Eayrs, S., Thorbjornson, T., Ford, J., Deese, H. and Smith, G. (2012) Saving fuel to increase profitability and reduce environmental impact in a U.S. ground fish fishery. In: Second International Symposium on Fishing Vessel Energy Efficiency E-Fishing, May 2012, Vigo, Spain.
- Economic Review (2016) State Planning Board, Thiruvananthapuram, Kerala, India, March, 2017 367p.
- Edwardson, W. (1976) The energy cost of fishing, *Fishing News International*. 15(2): 36-39.
- Edwin, L. and Hridayanathan, C. (1997) Energy efficiency in the ring seine fishery of south Kerala coast, *Indian Journal of Fisheries* 44 (4):387-392.
- Edwin, L., Thomas, S.N., Pravin, P., Remesan, M.P., Madhu, V.R., Biju, M.V., Sreejith, P.T., Ravi, R. and Das, D.P.H. (2014a) CIFT Fishing System Catalogue 1- Mechanised Marine Fishing Systems: Kerala, Central Institute of Fisheries Technology, Kochi, 113 p.
- Edwin, L., Pravin, P., Madhu, V.R., Thomas, S.N., Remesan, M.P., Baiju, M.V., Ravi, R., Das, D.P.H., Boopendranath, M.R. and Meenakumari, B. (2014b) Mechanised Marine Fishing Systems: India, Central Institute of Fisheries Technology, Kochi: 276 p.
- Effiong, J.A.L., Aligbe, J.O., Uzoho, B.U. and Eze, E.U. (2016). Cost structure of trawl fisheries in Nigeria. *International Journal of Advanced Academic Research* 2(2):1-6.
- Ellingsen, H. and Aanonsen, S. (2006) Environmental impacts of wild caught cod and farmed salmon - a comparison with chicken. *The International Journal of Life Cycle Assessment*. 11 (1), 60–65.

- Emanuelsson, A., Flysjö, A., Thrane, M., Ndiaye, V., Eichelsheim, J.L. and Ziegler, F. (2008) Life Cycle Assessment of southern pink shrimp products from Senegal. In: 6th International Conference on Life Cycle Assessment in the Agri-Food Sector, Zurich, 1-9.
- EMC (1991) Energy Conservation in Selected Government Farms, Energy Management Cell, New Delhi: 85 p.
- Endal, A. (1980) Fuel saving, *Fishing News International* 19(1 0): 16-17.
- Endal, A. (1989) Energy fishing - challenge and opportunities. In: Proceedings of the World Symposium on Fishing Gear and Fishing Vessel Design 1988, Marine Institute, St. John's, Newfoundland, Canada, 74-78.
- Eyjólfsdóttir, H., Yngvadóttir, E., Jónsdóttir, H. and Skúladóttir, B. (2003) Environmental effects of fish on the consumers dish – life cycle assessment of Icelandic frozen cod products. IFL Report 06-03, Reykjavik. Iceland, Technological Institute of Iceland and Icelandic Fisheries Laboratories: 40p.
- FAO (1974) Otter Board Design and Performance, FAO Fishing Manual, FAO, Rome: 82 p.
- FAO (1975) Catalogue of Small-scale Fishing Gear. Fishing News Books Ltd., Farnham, 191 p.
- FAO (1978) FAO Catalogue of Fishing Gear Designs, Fishing News Books Ltd., Farnham: 159 p.
- FAO (1995) Code of Conduct for Responsible Fisheries, FAO, Rome, 41 p.
- FAO (2007) The State of World Fisheries and Aquaculture 2006. FAO, Rome, 162 p.
- FAO (2012) The State of World Fisheries and Aquaculture (SOFIA) 2012, FAO, Fisheries and Aquaculture Department, Rome. <http://www>.

- fao.org/docrep/016/i2727e/i2727e00.htm, Accessed on 1st June 2013, 209 p.
- FAO (2016) The State of World Fisheries and Aquaculture 2016. Contributing to food security and nutrition for all. Rome. 200 p.
- Ferno, A. and Olsen, S. (Eds.) (1994) Marine Fish Behaviour in Capture and Abundance Estimation, Fishing News Books, Blackwell Science Ltd., Osney Mead, Oxford: 221 p.
- FERM (2004) ITQs, ageing boats, and the price of fish. Profitability and autonomous adjustment in the South East Trawl Fishery. Fisheries economics research and management Pvt. Ltd.
- Ferro, R.S.T. (1981) Choosing the size of suberkrub trawl board to suit a pelagic type four panel trawl. Scottish Fisheries Information Pomphle: (6): 15p.
- Ferro, R.S.T. (1988) Computer simulation of trawl gear shape and loading, Proceedings of World Symposium on Fishing Gear and Fishing Vessel Design, Marine Institute, Saint John's, 1988, 259-262.
- Fet, A. M., Schau, E. M. and Haskins, C. A. (2010) Framework for environmental analyses of fish food production systems based on systems engineering principles. Syst Eng 13(2):109–118.
- Fiorentini, L. and Cosimi, G. (1987) Performance tests on Italian bottom trawls. FAO, GFCM Studies and Reviews, Rome, 62: 1–17.
- Fiorentini, L., Messina, G. and Pietrucci, A. (1981) Analisi delle prestazioni dell'apparato propulsivo di un motopeschereccio adibito alla pesca al traino. Quad. Lab. Tecnol. Pesca, 3 (1): 87–112
- FRDC (2007) Fishing Energy Efficiency Review for the FRDC, 2005/239.

- Fredsøe, J. and Sumer, B.M. (1997) Hydrodynamics Around Cylindrical Structures, Advanced series on ocean engineering ; v. 12, World Scientific, Singapore ; River Edge, NJ.
- Fridman, A. L., and Danilov, Y.A. (1967) Ob Osobennostyah Soprotivleniya Rybolovnoi Seti (in Russian). Rybolovnoe Hozyajstvo. Vol 6, 38-40.
- Fridman, A. L. (1986) Calculations for fishing gear designs. Fishing news (Books) Ltd., England, 241p.
- Fridman, A.L. (1969) Theory and Design of commercial Fishing Gear. Translated from Russian by Israel Program for Scientific Translations, Jerusalem, 1973 : 489p.
- Froese, R. and Pauly, D. (eds) (2000) FishBase 2000: Concepts, Design and Data sources, ICLARM, Los Banos, Philippines, 346 p.
- Fujishi, A. (1985) Japan How big mesh save fuel. World Fishing. 34(7): 6p.
- Fyson, J.F. (1982) Low energy fishing vessels: the use of sails. In: May, R.C., Smith, L.R. and Thomson, D.B. (Eds.) (1982) Appropriate Technology for Alternative Energy Sources in Fisheries, Proceedings of the ADB-ICLARM Workshop On Appropriate Technology for Alternative Energy Sources in Fisheries, Manila, Philippines, 21-24 February, 1981, ICLARM Conf. Proc. 8, 15-47.
- Fyson, J. (Ed.) (1985) Design of Small Fishing Vessels, Fishing News Books Ltd, Farnham, Surrey, England: 319 p.
- Gabriel, O. (1987) Selection and use of bottom trawl boards. Fischerei. Forschung. 25(1): 41-45.
- Gallene, J. (1993) Offshore low energy fishing technology in the Bay of Bengal, In: Proceedings of the National Workshop on Low Energy

- Fishing, Fishery Technology, Special Issue, Society of Fisheries Technologists, Cochin, India,. 179-182.
- Garner, J. (1965) *World Fishing*, 14(I), 51-53.
- Garner, J. (1966) *Ibid*, I S(7), 42-43.
- Garner, J. (1973) *Modern Inshore Fishing Gear - Rigging and Mending*, Fishing News Books Ltd., Farnham, Surrey, Eng]and: 69 p.
- Garner, J. (1977) *Modern Deep Sea Trawling Gear*, Fishing News Books Ltd., Farnham, Surrey, England: 96 p.
- George, M. J., Suseelan, C., Thomas, M.M. and Kurup, N. S. (1980) A case of over fishing: Depletion of shrimp resource along Neendakara coast, Kerala. *Mar. Fish. Infor. Serv., T & E Ser.*, 18, 1-8.
- George, V.C. (1971) *An Account of the Inland Fishing Gear and Methods of India*, Spl. Bull. No. 1, Central Institute of Fisheries Technology, Cochin: 68 p.
- Ghosh, S., Rao, H.M.V., Kumar, S.M., Mahesh, U.V., Muktha, M. and Zacharia, P. U. (2014) Carbon footprint of marine fisheries: life cycle analysis from Visakhapatnam, *Current Science*, 107 (3): 515-521.
- Gibinkumar, T. R. (2008) *Investigations on hard bycatch reduction devices for trawling*, Cochin University of Science and Technology, Cochin, 223 p.
- Gifford, E.W.H (1982) Development of low energy fishing boats for tropical use , In: May, R.C., Smith, I.R. and Thomson, D.B. (Eds.) (1982) *Appropriate Technology for Alternative Energy Sources in Fisheries*, Proceedings of the ADB-ICLARM Workshop on Appropriate Technology for Alternative Energy Sources in Fisheries, Manila, Philippines, 21-24 February, 1981, ICLARM Conf. Proc. 8,. 55-63.

- Gjørsund, S.H. and Enerhaug, B. (2010) Flow through nets and trawls of low porosity, *Ocean Engineering*, vol. 37, no. 4,. 345-354.
- Gnanadoss, D.A.S. (1977) *Wither Mechanization? Silver Jubilee Souvenir of Integrated Fisheries Project, Cochin.* 6-8.
- GOI (2011) Report of the Working Group on development and management of fisheries and aquaculture, for the XII Five Year Plan (2012-17). Planning Commission, Government of India, New Delhi, 147 p.
- GOI (2016)
- Gopal, N., Jeeva, J.C. and Unnithan, G.R. (2008). Fuel consumption pattern by the mechanized fishing sector in Andhra Pradesh. *Fish. Technol.*, 45(1): 113 – 120.
- Graham, M. (1956) Concepts of conservation. Paper presented at the international Technical conference on the conservation of the living resources of the sea, U.N., New York,. 1-13.
- Grimaldo, E., Pedersen, R., and Sistiaga, M. (2015). Energy consumption of three different trawl configurations used in the Barents Sea demersal trawl fishery. *Fishery Research*, Vol. 165, . 71-73.
- Grofit, E. (1981) The fuel problem in trawl industry, *Fish. Fishbreed. Isr.* 16(2): 28-35.
- Gulbrandson, O. (1984) *Fishing Craft Development in Kerala: Evaluation Report, BOBP/WP/25, Bay of Bengal Programme, Madras, 23p.*
- Gulbrandsen, O. (1986) *Reducing Fuel Cost of Small Fishing Boats, BOBP/WP/27, Bay of Bengal Programme, Madras:15 p.*

- Gulbrandson, O. and Andersen, M.R. (1992) Introduction of New Small Fishing Craft in Kerala, India, BOBPIREP/49, Bay of Bengal Programme, Madras: 27 p.
- Guttormsdóttir, A. B. (2009) Life Cycle Assessment on Icelandic cod product based on two different fishing methods, Environmental impacts from fisheries, *Sigillium Universitatis Islandiae, Verkfræðideild Háskóli Íslands*, 106 p.
- Hameed, M.S. and Hridayanathan, C. (1989) Energy consumption pattern of fishing boats operating in the inshore waters of the south-west coast of India, Paper 1.4, In: Proceedings of International Fisheries Energy Optimisation Working Group Meeting, 28-30 August, 1989, University of British Columbia, Vancouver, B.C., Canada, 9p.
- Hameed, M.S., Bellaramine, K.C., Kumar, K.A. and Mukundan, M. (1989) Observation of the operation on mini trawl in the coastal waters of Kerala. In: Proceedings of the World Symposium on Fishing Gear and Fishing Vessel Design 1988, Marine Institute, St. John's, Newfoundland, Canada, 177-189.
- Hameed, M.S. and Kumar, K.A. (1993) Problems of energy optimisation in fisheries, In: Proceedings of the National Workshop on Low Energy Fishing, Fish. Technol., Special Issue, Society of Fisheries Technologists, Cochin, India. 91-92.
- Hameed, M.S. and Boopendranath, M.R. (2000) Modern Fishing Gear Technology, Daya Publishing House, Delhi: 186 p.
- Hansen, U.J. (2004) Performance of a trawl codend made from 90° turned netting (T90) compared with that traditional codends. ICES Fishing

- Technology and Fish Behaviour Working Group Meeting, Gdynia, April, 20-23: 17p.
- Hansen, U.J. and Tørring, P. (2012) Best available technology makes drastic cuts in fuel expenses in trawl fisheries, E-Fishing, Vigo, Spain
- Hanumanthappa, B. and Radcliffe, C. (1998) Model Testing of Midwater Trawl gear, University of Humberside (U.K.) (Report), 1-14.
- Hanumanthappa, B. (2009) Studies on the exploratory trawl fishing and significance of selectivity in trawl fishing gear for conservation of marine fishery resources with special reference to the inshore waters off Mangalore. Cochin University of Science and Technology, Cochin, 212 p.
- Hassan, F. and Sathiadas, R. (2009) An Appraisal of Trawl Fishery of Kerala. Asian Fisheries Science. 22: 277-284.
- Hirst, E. (1974) Food-related energy requirements. Science;184 (4133):134–138.
- Hjul, P. (Ed.) (1972) The Stern Trawler, Fishing News (Books) Ltd., Surrey, England: 221 p.
- Hollin, D. and Windh, S. (1984) Cutting fuel costs: alternatives for commercial fishermen. USA Texas A&M University Sea Grant College Program, 17p.
- Hopper, A. G. (1982) Energy Efficiency in Fishing Vessels. In. Fishing Industry Energy Conservation Conference. The Society of Naval Architects and Marine Engineers, New York. 55-82.
- Hospido, A. and Tyedmers, P. (2005). Life cycle environmental impacts of Spanish tuna fisheries. Fisheries Research, 76: 174-186.

- Hua, J. and Wu, Y.H. (2011) Implications of energy use for fishing fleet-Taiwan example. *Energy Policy* 39 (5), 2656-2668.
- Hunter, C. J. (1965) *Com. Fish Rev.* 17: 1-9.
- IBEF (2017) India Brand Equity Foundation, October 2017, 51p. https://www.ibef.org/download/Oil_and_Gas-October-_2017.pdf
- WTO (2015) Special focus: world trade and the WTO: 1995–2014, *International Trade Statistics*, World Trade organization, 166 p.
- Iribarren, D., Vázquez-Rowe, I., Hospido, A., Moreira, M.T. and Feijoo, G. (2010) Estimation of the carbon footprint of the Galician fishing activity (NW Spain). *Science of the Total Environment*, 408 (22): 5284–5294.
- Iyer Krishna H., Rajendran, R. and Choudhury Roy, R. L. (1968) Comparative Fishing Ability and Economic Efficiency of Mechanised Trawlers Operating along The Kerala Coast; *Fish Technology News Letter* , Vol.5, 71-80.
- Jeeva J. C., Gopal, N. and Unnithan G.R. (2008) Mechanized crafts of North Andhra coast- A study on status, operation and economic evaluation, *Fish. Technol.* 45(1): 103-108.
- Jiang, I. I. (1982) Development of low-energy fishing boats in Taiwan. In: May, R.C., Smith, I.R. and Thomson, D.B. (Eds.) (1982) *Appropriate Technology for Alternative Energy Sources in Fisheries*, Proceedings of the ADB-ICLARM Workshop on Appropriate Technology for Alternative Energy Sources III Fisheries, Manila, Philippines, 21-24 February, 1981, ICLARM Conf. Proc. 8, 71-74.

- John, A.T. (1996) Energy Optimisation Studies in Trawling Operations along Kerala Coast, Ph.D. Thesis, Cochin University of Science and Technology, Cochin: 213 p.
- John, A.T., Hameed, M.S., Ravindran, K. and Iyer, H.K. (1998) Energy efficiency with reference to energy yield of trawlers. In: Balachandran, K.K., Iyer, T.S.G., Madhavan, P., Joseph, I., Perigreen, P.A., Raghunath, M.R. and Varghese, M.D. (Eds.) Advances and Priorities in Fisheries Technology, Society of Fisheries Technologists (India), Cochin, 419-425.
- Joseph Mathai. T., Syed Abbas, M. Mhalathkar, H.N. (1984) Towards optimization of bridle lengths in bottom trawls, Fish. Technol .21(2):106-108.
- Joseph, K. M. (1973), Economics of Operation of the 17.5 m Indigeneous Steel trawlers along the Kerala Coast, Sea food Export Journal, Vol.7. 25-33.
- Joseph, K.M. (1985) Choice of size and type of deep sea trawlers for India. In: Ravindran, K., Nair, N.U.K., Perigreen, P.A., Madhavan, P., Pillai, A.O.O.K., Panicker, P.A. and Thomas, M. (Eds.) Harvest and Post-harvest Technology of Fish, Society of Fisheries Technologists (India), Cochin, 176-184.
- Jyothilal, K.R. (1998) Status of marine fisheries development in Kerala in Proc. Experience sharing workshop in Fisheries Sector Development for the state of Gujarat. 22-23.
- Kalawar, A.G., Devaraj, M. and Parulekar, A.K. (1985) Report of the Expert Committee on Marine Fishery Resources Management in Kerala. CIFE, Bombay, 432p.

- Karlsen, L. (1997) Redskapslære og fangstteknologi, Landbruksforlaget. In Norwegian, 520p.
- Kartha, K.N. and K.A. Sadanandan (1986). Two boat midwater trawling along the South West coast of India. Harvest and post-harvest technology of fish (Ravindran, K., Unnikrishnana, N., Perigreen, P.A., Madhavan, P., Gopalakrishna Pillai, A.G., Panicker, P.A. and Mary Thomas (Eds.) Society of Fisheries Technologists (India), Cochin: 249-250.
- Kartha, K.N., Hridayanathan, C. and Cecily, P.J. (1977) Comparative efficiency of trawls made of Nylon, polyethylene monofilament and tape twines. *Fish. Technol.*, 14(1): 21-26.
- Kartha, K.N., Kuttappan, A.C., Varghese, M.D., George, V.C., Rao, S.V.S.R. and Iyer, H.K. (1990) Design aspects of double rig shrimp trawlers operated off Visakhapatnam, *Fish. Technol.* 27(2): 92-97.
- Kelleher, K. (2005) Discards in world's marine fisheries, an update. FAO 2005, Fisheries Technical Paper No. 470. Food and Agriculture Organisation of the United Nations, Rome, 131p.
- Khaled, R. and Priour, D. (2010) Numerical method for energy optimisation of bottom trawl. In: First International Symposium on Fishing Vessel Energy efficiency, Vigo, Spain
- Khaled, R., Priour, D. and Billard, J.Y. (2013). Numerical optimization of trawl energy efficiency dependent of fish distribution *Ocean Engineering* 54: 34–45.
- Klust, G. (1955) *WId. Fish . Abstr .,6* : 13p .

- Kowalski, T. and Giannotti, I. (1974) Calculation of trawling gear drag. Mar. Tech. Rep. Rhode Island Un z'v., (16): 51p.
- Kristjonsson H., (ed). (1959) Modern Fishing Gear of the World 1, Papers and proceedings of the FAO International Fishing Gear Congress, Hamburg, October, 1957. London, Fishing News Books, 607p.
- Kristjonsson H. (ed). (1964) Modern Fishing Gear of the World 2, Fishing News (Books) Ltd., London: 600 p.
- Kristjonsson, H. (1967) Technique of finding and catching shrimp in commercial fishing, Proc. FAO World Scientific Conference on the Biology and Culture of Shrimps and Prawns, 12-24 June 1967, Ciudad de Mexico: 69 p.
- Kristjonsson H. (ed). 1971. Modern fishing gear of the world 3. Technical conference on fish finding, purse seining, aimed trawling, 3rd FAO Conference, Reykjavik, May 1970. London, Fishing News Books, 537p.
- Kunjipalu, K.K., Kuttappan, A.C. and George Mathai, P. (1979) A new large mesh trawl for demersal fishery. Fish. Technol., 16(1): 9-27.
- Kunjipalu, K.K., Boopendranath, M.R., Goplakrishnan, K. and Kuttappan, A.C. (1984) A new high opening trawl for Veraval waters, Fish. Technol. 21 (2): 86-90.
- Kunjipalu, K.K., Pillai, N.S. and Boopendranath, M.R. (1989) Performance of 25 m large mesh demersal trawl, Fish. Technol. 26(2): 95-99.
- Kunjipalu, K.K and Boopendranath, M.R. (1993) Investigations on flexible float - a canvas headline lifting device, Fish. Technol. 30(2): 94-98.

- Kunjipalu, K.K., Boopendranath, M.R. and Khan, M.Z. (1993) Investigations on dol nets of Gujarat coast. In: Proc. National Workshop on Low Energy Fishing, 8-9 August 1991, Cochin, Fish. Technol., Special Issue, Society of Fisheries Technologists (India), Cochin, 224-228.
- Kunjipalu, K.K., Varghese, M.D. and Nair, A.K.K. (1994) Studies on square mesh codend in trawls-I Studies with 30mm mesh size, Fish. Technol. 31(2), 112-117.
- Kunjipalu, K.K., Boopendranath, M.R., Pillai, N.S., Varghese, M.D., Mathai, T.J. and Meenakumari, B. (1998) Large mesh demersal and high opening trawls for fin fish and cephalopods. In: Balachandran, K.K., Iyer, T.S.O., Madhavan, P., Joseph, I., Perigreen, P.A., Raghunath, M.R. and Varghese, M.D. (Eds.) Advances and Priorities in Fisheries Technology, Society of Fisheries Technologists (India), Cochin, 160-164.
- Kunjir, S. N., Barve, S. K., Shirdhankar, M.M. and Markad, A.T. (2007) The Asian Journal of Animal Science Vol.2 No.1 & 2 : 49-54.
- Kurian, C. V. (1953) A preliminary survey of the bottom fauna and bottom deposits of the Travancore Coast within the 15-fathom line. Proc. nat. Inst. Sci. India, 19: 746-775.
- Kurian, G.K., Satyanarayana, A.V.V., Nair, R. S. (1964) Designs of trawling gear. Indo. Pacific. Fish. Coun. 11, 184p.
- Kurian, O.K. (1965) Trends in development in the prawn fishing techniques in India - a review, Fish. Technol. 2(1): 64-68.
- Kurien, J. (1985) Technical Assistance Projects and Socio-Economic Change: Norwegian Intervention in Kerala's Fisheries Development. Economic and Political Weekly, 20(25/26)

- Kurien, J. and Willmann, R. (1982) Economics of Artisanal and Mechanised Fisheries in Kerala. A study on Costs and Earnings of Fishing Units, Working paper No. 34, FAOUNDP, Madras, India: 114p
- Kurup, N.S., Sarada, P.T., Menon, K.K. and Lakshmi, S. (1993) Low energy fishing methods for the prawn fishery of Calicut, Kerala. In: Proceedings of the National Workshop on Low Energy Fishing, Fish. Technol., Special Issue, Society of Fisheries Technologists, Cochin, India, 130- 136.
- Kurup, M. B. and Rajasree, R. (2007) Status of bottom trawl fishery in Kerala, Fishery Technology. Society of Fisheries Technologists, India (SOFTI). 44: 99-108.
- Kuthalingam, M.D.K. (1965) A method for estimating trawler catches. Indian J. Fish 98-108.
- Kuthalingam, M.D.K., Livingston, P. and P. Sadasiva Sarma (1978) Observations on the catches of the mechanised boats at Neendakara. Indian J. Fish., 98-108.
- Kwidzinski, Z. (1989) Development of pelagic trawl construction aimed at fisheries energy optimisation, Paper 2.1, In: Proc. International Fisheries Energy Optimisation Working Group Meeting, 28-30 August, 1989, University of British Columbia, Vancouver, RC., Canada, 4p.
- Lam, V., Sumaila, U., Dyck, A., Pauly, D. and Watson, R. (2011) Construction and first applications of a global cost of fishing data base. ICES Journal of marine Science 68(9):1996-2004
- Lange (1985) Tests with economic catching methods in the German cutter fishery, Fischerei. Forschung. 23(3): 55-58.

- Larsson, K. H. (1952) Fishing News No. 2067 Fine Technical publication Ltd., 9 Noting St., London.
- Le Dret, H., Lewandowski, R.H., Priour, D. and Chagneau, F. (2004) Numerical Simulation of a Cod End Net, Part 1: Equilibrium in a Uniform Flow. *J. Elast.* 76, 139–162
- Le Floc'h, P., Boncoeur, J., Daurès, F. and Thébaud, O. (2007) Analysing fishermen behaviour face to increasing energy costs-A french case study, ICES ASC meeting Helsinki, ICES CM 2007/M:09, 17-21.
- Leach, G. (1976) Energy and Food Production. IPC Science and Technology Press, Guildford, England, 137p.
- Lee, K.S. and Son, Y.I. (1982) Combining sail and power in fishing vessels. In: May, RC., Smith, LR. and Thomson, D.B. (Eds.) (1982) *Appropriate Technology for Alternative Energy Sources in Fisheries, Proceedings of the ADB-ICLARM Workshop on Appropriate Technology for Alternative Energy Sources in Fisheries, Manila, Philippines, 21-24 February, 1981, ICLARM Conf. Proc. 8, 71-74.*
- Lee, C.W., Lee, J.H., Cha, B.J., Kim, H.Y. and Lee, J.H. (2005) Physical modeling for underwater flexible systems dynamic simulation. *Ocean Engineering* 32, 331–347.
- Lee, C. W., Lee, J. and Choe, M.Y. (2010) Low-Carbon Fishing Gear Design Using Numerical Methods First International Symposium on Fishing Vessel Energy Efficiency E-Fishing, Vigo, Spain.
- Lonnevik, M.S. (1989) Effects of hanging ratios on trawls. In: Proc. of the 1988 world symp. On Fishing Gear and Fishing Vessel Design: 318- 320.
- Lorentzen, G. (1978) Energy account of the Norwegian fishing sector. *Meldingen SSFM2*, 5–9.

- Lowe, T (1996) An Analysis of the Gains in Engineering Performance Achieved by Constructing Australian Prawn Trawls from Spectra Netting, B.Sc. Thesis, Australian Maritime College.
- MacLennan, D.N. (1973) Engineering characteristics of single boat pelagic gears for vessel powers between 200 and 2000 hp. ICES, C.M. 1973, Document B: 21. 16 p.
- MacLennan, D.N. (1981) The drag of four panel demersal trawls. *Fish. Res.*, (1): 23-33.
- Madhu, V.R. and Panda, S.K. (2009) Effect of Tow Duration and Speed on the Capture Efficiency of Bottom Trawl, *Fishery Technol*, 46 (1): 25-32.
- Manikandan, N. (2005) Comparative studies on the catching efficiency of large mesh trawl and high opening bottom trawl off Someshwar. M.F.Sc. thesis submitted to K. V.A.F.S. U., Bidar.
- Manjarrés-Martínez, L. M., J. C. Gutiérrez-Estrada, J. A. Hernando (2015) Effects of mesh size and towing speed on the multispecies catch rates of historical swept area surveys. *Fisheries Research*, 164(0): 143-152.
- Manoharados, R.S., Mathai, P.G., Puthra, P. and Rajan, K.V.M. (1993) Effect of heavy bridles on the performance of demersal trawls. *Fish. Technol.*, 30(1): 6 - 18.
- Manoharadoss, R.S. and Puthra, P. (1998) Large mesh trawl for quality fishes. In *Proceedings of the symposium, Advances and priorities in Fisheries Technology*, (Balachandran, K.K. Iyer, T.S.G., Madhavan, P.J. Joseph, J., Perigreen, P.A., Raghunath, M.R. and Varghese, M.D., Eds), Society of Fisheries Technologist (India), Cochin, 151-154.

- Marlen, B.V. (1989a) A decade of research and development of mid-water trawls in the Netherlands. In: Proceedings of the World Symposium on Fishing Gear and Fishing Vessel Design 1988, Marine Institute, St. John's, Newfoundland, Canada, 141-153.
- Marlen, B. V. (1989b) The energy saving potential of high strength materials in super-mesh trawls, Paper 2.2, In: Proc. International Fisheries Energy Optimisation Working Group Meeting, 28-30 August, /989, University of British Columbia, Vancouver, B.C., Canada.
- Mathai, T.J., Abbas, M.S., Manoharadoss, R.S. and Vijayan, V. (1993) On the efficacy of a platform in a semi-pelagic trawl. *Fish. Technol.*, 30(2): 99-101.
- May, R.C., Smith, I.R. and Thomson, D.B. (Eds.) (1982) Appropriate Technology for Alternative Energy Sources in Fisheries, Proceedings of the ADB-ICLARM Workshop on Appropriate Technology for Alternative Energy Sources in Fisheries, Manila, Philippines, 21-24 February, 1981, ICL~RM Conf. Proc. 8 : 215 p.
- McLaughlin, K. (1986) Choosing the right door. *World Fish.*, 35(2): 11-12. *Mem. Fac. Fish., Kagoshima Univ.*, 28:73-99.
- Meenakumari, B., Boopendranath, M. R., Puthra, P., Thomas, S. N and Edwin, L. (2009). (Eds): *Hand Book of fishing Technology*, Central Institute of Fisheries Technology, Cochin: vii, 372 p.
- Mhalathkar, H.N., Vijayan, V., Mathai, T.J. and George, T.P. (1983) One boat midwater trawling with unequal panel trawl, *Fish. Technol.* 20(1):1-4.
- Milne, P. H. (1979) *Fish and Shellfish Farming in Coastal Waters*, Fishing News Books Ltd, England.

- Misund, O. A., Kolding, J. and Fréon, P. (2002) Fish capture devices in industrial and artisanal fisheries and their influence on management. In P. J. B. Hart and J. D. Reynolds, editors. Handbook of fish biology and fisheries, volume 2. Blackwell Scientific Publications, Malden, Massachusetts, 13–36.
- Mitchell, C. and Cleveland, C. J. (1993) Resource Scarcity, Energy Use and Environmental Impact: A Case study of the New Bedford, Massachusetts, USA, Fisheries. *Environmental Management*, 17(3): 305-317.
- Mittal, J.P. and Dhawan, K.C. (1988) Research Manual on Energy Requirements in Agricultural Sector, College of Agricultural Engineering, Punjab Agricultural University, Ludhiana: 150 p.
- Miyamoto, H. (1959) On the relation between trawling gear and towing power. In: Kris~jonsson H. (Ed.) *Modern Fishing Gear of the World*, Fishing News (Books) Ltd., London, 248-250.
- Moderhak, W. (2010) T90 technology for Baltic cod fishing -minimizing negative consequences for the marine environment – Presented in LIFiBS meeting Berlin, November 18, 2010
- Mohankrishna, K.V. (1985) Comparative study on the catching efficiency of conventional four-seam trawl and High Opening Bottom Trawl (fish-cum-shrimp) in the inshore waters of Arabian sea off Mangalore. M.F.Sc. Thesis, Univ. Agric. Sci., Bangalore, 134 p.
- Mohanrajan, K. V. (1987) Energy alternatives in fisheries sector, *Fishing Chimes* 6(11): 45-50.

- Mohanrajan, K.V., Boopendranath, M.R. Mathai George, P. and Pillai, S.N. (1990) Studies on optimisation of bridle lengths for demersal trawlers. *Fish. Technol.* 27: 87-91
- Montgomerie, M. (2009) SR625_Jackson Low Drag Trawl Sea Trials – Trial 1 MFV Harvest Hope. *Seafish Research & Development*. 20p.
- Mounsey, R.P. and Prado, J. (1997) Eco friendly demersal fish trawling systems. *Fish. Technol.*, 34(2): 1-6.
- Mugas, N. (1959) Experiments with Synthetic Materials in the Norwegian Fishereis. In: *Modern Fishing Gear of the World*. Voll. Kristjonsson, H.(Ed.), Fishing News (Books) Ltd., London, 159-162.
- Muir, J. F. (2015) Fuel and energy use in the fisheries sector Approaches, inventories and strategic implications. *FAO Fisheries and Aquaculture Circular No. C1080*. 94p
- Mukundan, M., Satyanarayana, A.V.V., Iyer, H.K., Nair, R.S. and George, N.A. (1967) On the relative efficiency of different shaped otter boards, *Fish. Technol* 4(2): 53-61.
- Mukundan, M. (1970) The design and construction flat rectangular otter boards for bottom trawling- A review. *Fish. Technol.*, 7(1): 1-19.
- Mukundan, M. and Hameed, M.S. (1993). Present status of Trawl Designs in Cochin area. *J. Mar. Biol. Ass. India*. 35 (1 & 2): 109-113.
- Mukundan, M. and Hameed, M. S. (1995) Calculated and measured trawl drag comparison. *Fish. Technol.*, 32 (1): 61 - 63.
- Naidu, R., Ramarao, S.V.S., Narayanappa, G., Satyanarayana, A.V.V., Sitaramarao, J. and Nair, A.K.K. (1987) Effect of variation in mesh size on trawl efficiency. *Fish. Technol.*, 24(2): 79-82.

- Nair, R.S. and George, N.A. (1964) The four seam trawl nets operated off Cochin : An analysis of the design aspects and the integration of the various parts of trawl. *Fish. Technol.* 1: 98-100.
- Nair, R. S. (1969) General principles of the design of trawl net. *Fish. Technol.* 1: 1-8
- Nair, R.S., Verghese, C.P., Gopalan Nayar, S., Syed Abbas, M. and Kuriyan, G.K. (1971) Studies on the length of overhang for trawls. *Fishery Technology*, 8(1), pp. 19-22.
- Nair, N.B. (1989) Report of the Expert Committee on Marine Fishery Resources Management in Kerala, Balakrishnan Nair Committee, Government of Kerala: 104 p.
- Nair, M.K.R. (1999) Indian marine fishing sector- An overview. In: Ravindran, K., Srinath, K., Kunjipalu, K.K., Sasikumar, V., Kadalekum Kanivukal, Bounties of the Sea, Central Institute of Fisheries Technology, Cochin,. 1–6.
- Nair, R. J., Manoj Kumar, P. P., Zacharia, P. U., Mohamed, K. S., Sathianandan, T. V., Somy Kuriakose, Asokan, P. K., Venkatesan, V., Said Koya, K. P., Abdussamad, E. M., Lakshmi Pillai, S., Najmudeen, T. M., Ganga, U. , Aswathy, N., Josileen Jose, Rekha Devi, Chakraborty, Saleela, K. N., Seetha, P. K., Radhakrishnan, M., Paulose Jacob Peter, Prakasan, D., Rema, K. V., Baby P. K. and Sindhu K. Augustine (2015) Status of marine fisheries of Kerala. Marine Fisheries Information Service; Technical and Extension Series (226). 22-26.
- Najmudeen, T. M. and Sathiadhas, R. (2007) Economic efficiency of input utilisation of mechanised trawlers along the Kerala coast. *J. Mar. Biol. Ass. India*, 49(2): 113-117

- Nakamura (1971) Trawling gear in Japan. In: Modern Fishing Gear of the World: Kristjonsson, H. (Ed.), Fishing News (Books) Ltd., London, 3 : 456-462.
- Nakasai, K. and Kawakami, T. (1965). On a simple estimation of working depth of Midwater Trawl. Bull. Jap. Soc. Sci., 31, (4), 277-280.
- Narayanappa, G. (1968) On the relative catch efficiency of different shaped otter boards in bottom trawling. Fish. Technol., 5(1): 15-20.
- Nasar, M. (1998) Fuel saving in fishing by improving propeller design. In: Balachandran, K.K., Iyer, T.S.G., Madhavan, P., Joseph, I., Perigreen, P.A., Raghunath, M.R. and Varghese, M.D. (Eds.) Advances and Priorities in Fisheries Technology, Society of Fisheries Technologists (India), Cochin, 419-425.
- Nayak, B.B. (1991) Study on the efficiency of a new large mesh trawl in relation to that of a high opening bottom trawl for demersal trawling. M. F. Sc. Thesis, Univ. Agric. Sci., Bangalore, 135p.
- Nayak, B.B. and Sheshappa, D.S. (1993) Effect of large meshes on the body of trawl net in energy conservation, Fish. Technol. 30(1): 1-5.
- Nedlec, C. (1982) Definition and classification of fishing gear categories, FAO Fish. Tech. Pap. 222: 51 p.
- Neethiselvan, N. and Brucelee, G. (2003) Analysis of design features of fish trawls and shrimp trawls of Thoothukkudi Coast. Fish. Technol., 40(1): 18-23.
- Niedzwiedz, G. and Hopp, M. (1998) Rope and net calculations applied to problems in marine engineering and fisheries research, Archive of Fishery and Marine Research, 46, 125 – 138.

- Nomura, M. and Yamazaki, T. (1975) Fishing techniques - 1: Compilation of Transcript of Lecturers Presented at Training Department, SEAFDEC, Japan International Co-operation Agency: 206 p.
- Nomura, M. (1980) Influence of fish behaviour on use and design of set nets. In: Bardach, I.E., Magnuson, J.I., May, R.C. and Reinhart, J.M. (Eds.) Fish Behaviour and its Use in the Capture and Culture of Fishes, ICLARM Conference Proceedings 5, International Centre for Living Aquatic Resources Management, Manila, Philippines, 446-472.
- Nomura, M. (1981) Fishing Techniques - 2: Compilation and Transcript of Lectures Presented at Kanagawa International Fisheries Department, Japan, Japan International Co-operation Agency, Tokyo: 183 p.
- Okonski, S. and Sadowski, S. (1959) The Headline, the footrope and their influence on the vertical opening of the mouth of the trawl. In: Modern Fishing Gear of the World, Kristjonsson, H. (ed.) Fishing News (Books) Ltd., London, 1: 196-199.
- Pajot, G., Crockett, J., Pandurangan, S. and Ramamurthy, P.V. (1982) Further trials of mechanized trawling for food fish in Tamil Nadu. BOBP/WP/ 20: 14-28.
- Pajot, G. and Mohapatra, B.B. (1986) Fishing trials with high opening bottom trawls from Chandipur, Orissa, India. BOBP/WP/48:14pp.
- Panayotou, Y. Adulavidhaya, K., Astachinda, S., Isvilanand A.S., and Jitsanganan, T. (1985). Socio Economic Conditions of Coastal Fishermen in Thailand - A cross section profile. In: Small Scale Fisheries in Asia: Socio Economic Analysis and Policy. (Panayotou T. edn). International Development Research Centre Ottawa, 46-54.

- Panayotou, T. and Jetanavanich, S. (1987) The economics and management of Thai marine fisheries. ICLARM -studies and reviews No. 14. Man. 82 p.
- Pandurangan, S. and Ramamurthy, P.V. (1983) High opening bottom trawling in Palk Bay and Gulf of Mannar. Fish. Chimes, 3(1): 19-23.
- Panicker, A.P. and Sivan, T.M. (1965) On the selective action of codend meshes of a shrimp trawl. Fish Technol., 2(2): 220-248.
- Panicker, P.A., Sivan, T.M., Rao, S.V.S.R. and George, T.P. (1977) Double-rig trawling - its rigging, comparative efficiency and economics, Fish. Technol. 14(2): 141-152.
- Panicker, P.A., Sivan, T.M., Mhalathkar, H.N. and Mathai, P.G. (1978) Selectivity of gill net for *Hilsa ilisha* and *Pampus argenteus*, Fish. Technol. 15: 6 I -68.
- Panikkar, K. K. P., Sathiadas. R. and Kanakkan. A. (1991) A study on the economics of the different fishing techniques along the Kerala coast with special reference to fuel efficiency. Proc. National Workshop on Low Energy Fishing. 8-9 August 1991, Cochin. 265—271.
- Panikkar, K.K.P., Sathiadas, R. and Kanakan, A. (1993). A Study on Economics of Different Fishing Techniques Along Kerala Coast with Special Reference to Fuel Efficiency. In: Low Energy Fishing, Fish. Technol., (Special Issue on Low Energy Fishing) Society of Fisheries Technologists (India), Cochin, 265-271.
- Parente, J., Fonseca, P., Henriques, V. and Campos, A. (2008) Strategies for improving fuel efficiency in the Portuguese trawl fishery. Fisheries Research 93: 117–124.

- Park, J.A., Gardner, C., Chang, M.I., Kim, D.H., and Jang, Y.S. (2015). Fuel use and greenhouse gas emissions from offshore fisheries of the Republic of Korea. *PLoS One*, 10(8), E0133778, 12p.
- Parker, R.W.R. and Tyedmers, P. (2015) Fuel consumption of global fishing fleets: Current understanding and knowledge gaps. *Fish and Fisheries*. 16(4): 684–696.
- Parker, R.W.R., Hartmann, K., Green, B.S., Gardner, C., & Watson, R.A. (2015). Environmental and economic dimensions of fuel use in Australian fisheries. *Journal of Cleaner Production*, 87, 78-86.
- Parrish, B.B. (1959) Discussion on relative efficiency of nets made of different materials. In: *Fishing gear of the world*. H. Kristijonsson (Ed). Fishing News (Books) Ltd., London: 164-165.
- Pelletier, N.L., Ayer, N.W., Tyedmers, P. H., Kruse, S. A., Flysjo, A., Robillard, G., Ziegler, F., Scholz, A. J. and Sonesson, U. (2007) Impact categories for Life Cycle Assessment research of seafood production systems: Review and prospectus. *The International Journal of Life Cycle Assessment*, 12(6): 414-421.
- Pelletier, N., Andre, J., Charef, A., Damalas, D., Green, B., Parker, R. and Watson, R. (2014) Energy prices and (sea)food security. *Glob. Environ. Change* 24, 30-41.
- Phillips, J. (1959) The mouth of the trawl. In: *Modern Fishing Gear of the World*, Kristjonsson H. (ed.), Fishing News (Books) Ltd., London, 1 : 200-204.
- Pillai, N.S., Vijayan, V., and Nayar, S.G. (1973) Effect of weight of otter boards on the horizontal opening of trawl nets. *Fish. Technol.*, 10(1): 52-54.

- Pillai, N.S., George, N.A., and Nair, A.K.K. (1979) Evolution of suitable net for medium sized vessels. II: Introduction of large meshed high opening fish trawl. *Fish. Technol.*, 16(2): 65-70.
- Pillai, P.K.M., Balakrishnan, G., Philipose, V. and Rajendran, V. (2000) An appraisal on the marine fishing craft and gear of the Indian coast, In *Marine fisheries research and management*. Eds V.N. Pillai, N.G. Menon. CMFRI, Cochin, 190-221.
- Pillai, N.S., Varghese, M.D. and Mathai, T.J. (2004). Performance evaluation of different types of selective devices for reduction of bycatch in shrimp trawl, In: Somvanshi, V.S. (Ed.) *Large Marine Ecosystems: Exploration and Exploitation for Sustainable Development and Conservation of Fish Stocks*, Fishery survey of India, Mumbai, 569-576.
- Pinhorn (1986) Vessel analysis computing system (Ener Sea), *Can. Tech. Rep. Fish. Aquat. Sci.* 1529: 39 p.
- Port, D., Perez, J.A.A. and Menezes, J.T. (2016) Energy direct inputs and greenhouse gas emissions of the main industrial trawl fishery of Brazil. *Mar. Pollut. Bull.* <http://dx.doi.org/10.1016/j.marpolbul.2016.03.062>.
- Prado, J. (1977) Dragging and scrapping in bottom trawling. *Peche Marit.*, No.1189: 223-225.
- Prat, J., Antonijuan, J., Folch, A., Sala, A., Lucchetti, A., Sarda, F., Manuel, A. (2008) A simplified model of the interaction of the trawl warps, the otterboards and netting drag. *Fish. Res.* 94, 109–117.

- Pravin, P., Remesan, M. P., Madhu, V. R. and Boopendranath, M. R. (Eds.) (2013) Trawl designs developed at CIFT for small, medium and large trawlers. CIFT Information Series, Central Institute of Fisheries Technology, Cochin, 108p.
- Priour, D. (1999) Calculation of net shapes by the finite element method with triangular elements. *Communications in Numerical Methods in Engineering*, 15(10), 755-763.
- Priour, D. (2009) Numerical optimization of trawls design to improve their energy efficiency. *Fish Res*; 98(1–3):40–50.
- Quevedo, J. (2001) Shrimp Trawl design improvements suggested for Mexcian fisheries. Final project, United Nations University Fisheries Training Programme, /[http://www.unuftp.is/proj01 /JosePRF.pdf](http://www.unuftp.is/proj01/JosePRF.pdf)S.
- Radhalakshmi, K. and Nayar, S.G. (1985). Fishing Experiments with Newer Materials, In: *Harvest and Post-harvest Technology of Fish*, Ravindran, K., Unnikrishnan Nair, N., Perigreen, PA., and Mary Thomas (Eds.). Society of Fisheries Technologists (India), Cochin, 262-263.
- Raja, B.T.A. (1987) High opening bottom trawling in Tamil Nadu, Gujarat and Orissa, India : A summary of effect and impact. BOBP/WP/37: 25 p.
- Rajasenan, D. (1987) The fishing industry in Kerala problems and potentials, Ph.D. Thesis. Cochin University of Science and Technology Cochin, India, 414p.
- Rajeswari, G., Raghu Prakash, R. and Sreedhar, U. (2012) Trawl Designs Used in Small-scale Mechanised Fisheries Sector of Andhra Pradesh, India, *Fishery Technology*, 49(1) 18-27.
- Rao, S. N. (1986) *Economics of Fisheries*. Daya Publishing House Delhi, (Ed)

- Rao, S.Y.S.R. and Narayanappa, G. (1994) Performance of 25 m rope trawl in inshore waters, *Fish. Technol.* 31(2): 118-122.
- Rao, S.Y.S.R., Pillai, N.S., Boopendranath, M.R. and Abbas, M.S. (1994) Performance of a rope trawl in deep waters off Northwest coast of India, *Fish. Technol.* 31(2): 127-132.
- Ravi, R., Vipin, P. M., Boopendranath, M. R., Joshy, C. G. and Edwin, L. (2014) Structural changes in the mechanised fishing fleet of Kerala, South India. *Indian J. Fish.*, 61(2): 1-6.
- Ravi, R. (2015) Studies on Structural Changes and Life Cycle Assessment in Mechanised Trawl Fishing Operations of Kerala. Ph.D. Thesis. Cochin University of Science and Technology. p 314
- Ravindran, K. and Baiju, M. V. (1998) In: M. Shahul Hameed and B.Madhusoodana Kurup (Eds.) Technological advancements in Fisheries. Publ n 1. School of Indl. Fish, Cochin Univ.of Sci .and Tech. 166-173.
- Rawitscher, M. A. (1978) Energy Cost of Nutrients in the American Diet . PhD Thesis, University of Connecticut, Storrs, Connecticut.
- Rawitscher, M. and Mayer, J. (1977) Nutritional outputs and energy inputs in seafood. *Science* 198: 261–264.
- Reddy, M. (2004) Economic analysis of artisanal fisheries in Fiji: issues of profitability and sustainability. *South Pacific Studies*; 25:35–48.
- Reid, A.J. (1977) A net drag formula for pelagic trawls, *Scott. Fish. Res. Pap.* No. 7: 12 p.
- Remesan, M.P. and Ramachandran, A. (2005) Mini-trawls for estuarine fishing in Kasargod district. *Fishery Technol.* .42 (1) :41-46.

- Remesan, M.P., Madhu, V.R., Sayana, K.A., Prabeeshkumar, M.V., Harikrishnan, K.R. and Edwin, L. (2017). Fuel saving through material substitution in trawls. *Fish Tech Reporter* 3(1):3-5
- Rihan, D. (2005) A comparison of twin-rig and single-rig trawling in terms of relative fishing efficiency, in *Economic performance and fishing efficiency of marine capture fisheries*, FAO fisheries technical paper 482, ISSN 0429-9345.
- Rochereau, S. P. (1976) Energy analysis and coastal shelf resource management: Nuclear power generation vs. seafood protein production in the Northeast region of the U.S. Ph.D. Dissertation. Cornell University.
- Sabu, S. (2008) Studies on soft bycatch reduction devices for selective trawling. Cochin University of Science and Technology. 208p.
- Sahu, B. and Sheshappa, D.S. (1998) V-shaped otter boards in bottom trawling. In: Balachandran, K.K., Iyer, T.S.G., Madhavan, P., Joseph, I., Perigreen, P.A., Raghunath, M.R. and Varghese, M.D. (Eds.) *Advances and Priorities in Fishery Technology*, Society of Fisheries Technologists (India), Cochin, 147-150.
- Sainsbury, J.C. (1971). *Commercial Fishing Methods*, Fishing News (Books) Ltd., London, 119 p.
- Sainsbury, J.C. (1996) *Commercial Fishing Methods - An Introduction to Vessels and Gear*, Fishing News Books Ltd., Farnham: 352 p.
- Sala, A., Hansen, K., Lucchetti, A. and Palumbo, V. (2008) Energy saving trawl in Mediterranean demersal fisheries. In: Soares, C.G., Kolev, P. (Eds.), *Maritime Industry, Ocean Engineering and Coastal Resources*. Taylor & Francis Group, London, ISBN: 978-0-415-45523-7, 961–964.

- Sala, A., De Carlo, F., Buglioni, G. and Lucchetti, A. (2011) Energy performance evaluation of fishing vessels by fuel mass flow measuring system. *Ocean Engineering* 38, 804–809.
- Sala, A., Notti, E. and Buglioni, G. (2012) Audit Energetici nel settore della pesca eAudit, (Progetto FEP 02ACO201109), CNR-ISMAR, Ancona, Rapporto Finale Progetto e-Audit, 43p.
- Sathiadhas, R. and Narayanakumar, R. (2001) Export of finfish Impact on domestic trade and production. In: Menon, N. G. and Pillai, P. P. (Eds.), *Perspectives in mariculture*, The Marine Biological Association of India, Cochin, 441-450.
- Sathiadhas, R. (1998) Marine fisheries in Indian economy. In: Balachandran, K.K., Iyer, T.S.G., Madhavan, P., Joseph, I., Perigreen, P.A., Raghunath, M.R. and Varghese, M.D. (Eds.) *Advances and Priorities in Fishery Technology*, Society of Fisheries Technologists (India), Cochin, 463-472.
- Sathiadhas, R. and Panikkar, K.K.P. (1989) Costs and earnings of trawlers operating at Tuticorin fisheries harbour (Tamil Nadu). *Marine Fisheries Information Service, Technical and Extension Series* 100, 1-8.
- Sathiadhas, R., Panikkar, K.K.P. and Kanakkan, A. (1992) Costs and earnings of trawl operations along Nagapattinam coast of Tamil Nadu. *Marine Fisheries Information Services*, 118: 4-11.
- Sathianandan, T. V., Jayasankar, J., Vivekanandan, E., Narayankumar, R. and Pillai, N. G. K. (2008) Estimates on potential yield and maximum sustainable fleet size for marine fisheries in Kerala, *Journal of Marine Biological Association of India*, 50 (2): 196 – 201.

- Satyanarayana, A.V.V., Kuriyan, G.K. and Nair, R.S. (1962) Commercial trawling gear of Cochin (India), Proc. Ind. Paci. Fish. Coun. 10 (II): 226-263.
- Satyanarayana, A.V.V. and Nair, R.S. (1964). Towing resistance of otter trawls used for shrimps from small mechanized boats. Fish. Technol., 1(2): 183-189.
- Sathyanarayana, A.V.V., Narayanappa, G. and Narashima Raju, D.A. (1970) On the relative utility of different methods to increase the vertical height in an otter trawl. Fish. Technol., 7(1): 23-32.
- Satyanarayana, A.V.V., Narayanappa, G. and Narasimha Raju, D.A. (1972) On the comparative fishing experiments with a four seam and a two seam trawls on the east coast, Fish. Technol. 9: 160-179.
- Sathyanarayana, A.V.V. and Narayanappa, G. (1976) Preliminary observation in the design and operation of a three panel, double trawl net. Fish. Technol., 13(1): 54 -58.
- Satyanarayana, A.V.V., Gopalakrishnan, K. and Ramarao, S.V.S. (1985) In proceedings of the symposium on Harvest and Post-harvest technology of fish, (Ravindran, K., Nair, N.U., Perigreen, P.A., Madhavan, P., Pillai, A.G.G., Paniker, P.A. & Thomas, M., Eds.) Society of Fisheries Technologists (India), Cochin, India, 216.
- Sayana, K.A., Ramesan, M.P., Madhu, V.R., Pravin, P. and Edwin, L. (2016) Appraisal of trawl design operated along Kerala coast. Fish. Technol. 53: 30-36.
- Scariah, K.S., Devaraj, M., J. Andrews, Seyrudeen, Beena, M.R. and Sindhu, A. K. (1999) Production pattern in the marine fisheries of Kerala Cont. Mar. Fish.Res. Inst. Kochi, 2-127.

- Scharfe, J. (1959) National study of Mediterranean type of trawl. Stud. K Rev. Gen.Fish. Coun. M€dii., 6(II, III report): 1-18.
- Schau, E. M., Ellingsen, H., Endal, A. and Aanonsen, S. A. (2009) Energy consumption in the Norwegian fisheries, Journal of Cleaner Production, 17(3): 325–334.
- Schau, E. M. (2012) Environmental life cycle assessments of fish food products with emphasis on the fish catch process. Department of Industrial Economics and Technology Management. Trondheim, Norway, NTNU, Norwegian University of Science and Technology. Thesis for the degree of philosophiae doctor.
- Scofield, W.L. (1948) Trawling gear in California, Fish. Bull. 72, State of California, Dept. of National Resources, Division of Fish and Game, California: 60 p.
- SEAFDEC (1986) Fishing Gear and Methods of Southeast Asia Vol. I: Thailand, Training Department, Southeast Asian Fisheries Development Centre, Samutprakarn: 329 p.
- SEAFDEC (1989) Fishing Gear and Methods of Southeast Asia Vol. II: Malaysia, Training Department, Southeast Asian Fisheries Development Centre, Samutprakarn: 338 p.
- SEAFDEC (1995) Fishing Gear and Methods of Southeast Asia Vol. III: The Philippines, TDIRES 38, Training Department, Southeast Asian Fisheries Development Centre, Samutprakarn: 341 p.
- Seafish, IFREMER & DIFT A (1993) Otterboard performance and behavior. Seafish Industry Authority, Hull, UK; IFEMER, Brest, France; and DIFTA, Hirtshals, Denmark: 138 p.

- SEC (2008) The role of the CFP in implementing an ecosystem approach to marine management. Report of the adhoc meeting of independent experts on indicators and associated data requirements to measure the impacts of fisheries on the marine ecosystem. Commission staff working document. Accompanying the document. Communication from the Commission to the Council and the European Parliament. SEC (2008) 449p.
- Sehara, D.B.S., Karbhari, J.P. and Salini, K.P. (1991) Economic feasibility of trawling in Maharashtra. Marine Fisheries Information Service, Technical and Extension Series 114, 8- 15.
- Sehara, D.B.S. and Kanakkan, A. (1992) Profitability level of trawlers operating from Cochin fisheries harbor. Seafood Export Journal, May, 1992: 14-20
- Sehara, D.B.S. and Kanakkan, A. (1993) Costs and earnings of trawlers in Kerala - A case study. Marine Fisheries Information Service, Technical and Extension Series 122, 14-18.
- Sehara, D.B.S., Panikkar, K.K.P. and Salini, K.P. (1993) Performance of medium and small trawler in Andhra coast. Marine Fisheries Information Service, Technical and Extension Series 122, 19- 22.
- Sehara D.B.S., Kanakkan, A. and Salini, K. P. (1994) Economics of Trawling along Goa Coast. Marine Fisheries Information Service, CMFRI, Cochin, No. 126,. 10-11.
- Sehara, D. B. S. (1998) Economic sustainability and management issues of trawl fishing in Gujarat. Marine Fisheries Information Service No.156. 11p

- Sehara, D. B. S., Sathiadhas, R., Panikkar, K. K. P. and Narayanakumar, R. (2000) Economic evaluation of different types of fishing methods along Indian coast. In: Marine Fisheries Research and Management. Pillai, V N and Menon, N G,(eds.) CMFRI; Kochi, Kochi, pp. 846-857.
- Sendlak, H., Nowakowski, P. and Winiarski, J. (2001) Fisheries: Analysis of geometric and drag related characteristics of pelagic trawls with components made of dyneema polyethylene fibres. *Electronic J. Polish Agri. Universities* 4(2). <http://www.ejpau.media.pl/volume4/issue2/fisheries/art-01.html>
- Senthilathiban, R., Venkataramanujam, K., Selvaraj, P. and Sanjeeviraj, G. (1996). Determinants of costs and profit in mechanized fishing in Tuticorin fishing harbour, Tamil Nadu. *Journal of Fisheries Economics and Development*, 3: 1-9.
- Senthilathiban, R., Venkataramanujam, K., Selvaraj, P. and Sanjeeviraj, G. (1997) Costs and earnings of trawlers operating at Tuticorin, Tamilnadu. *Fish. Technol.*, 34 (2): 31–34.
- Senthilathiban, R., Selvaraj, P. and Ramkumar, R. K. (1999). Economic feasibility of trawling operation off Tuticorin coast. *Fish. Technol.*, 36: 129-131.
- Shanis, R. C. P. (2014) deep-sea shrimp fishery off Kerala coast with emphasis on biology and population characteristics of *Plesionika quasigrandis* chace, 1985. Cochin University of Science and Technology. 192p.
- Shibu, A. V. and Hameed, M.S. (1999) Comparative evaluation of different types of otter boards in small-scale trawling operations, *Fish. Technol.* 36(1): 48-51.

- Shibu, A.V. (1999) Comparative Efficiency of Different Types of Mechanised Fishing Operations along the Cochin Coast, Ph.D. Thesis, Cochin University of Science and Technology, Cochin: 217 p.
- Sreekrishna, Y. and Narayanappa, G. (1970) On the trend of prawn catches in bottom trawls in inshore waters off Kakinada (Andhra Pradesh), *Fish. Technol.* 7: 33-37.
- Sreekrishna, Y. and Shenoy, L. (2001) Fishing gear and craft technology. Indian Council of Agricultural Research. New Delhi, 342p.
- Economic Review (2016) State Planning Board of Kerala, Government of Kerala, Thiruvananthapuram, <https://kerala.gov.in/documents/10180/ad430667-ade5-4c62-8cb8-a89d27d396f1>.
- Steinberg, R. (1985) Fisheries with gill and trammel nets and their applicability in the Baltic and North Sea, *Protok. Fishereitech.* 15 (68): 7-96.
- Sterling, D. and Eayrs, S. (2010) Trawl-gear Innovations to Improve the Energy Efficiency of Australian Prawn Trawling, paper presented to 1-st International Symposium in Fishing Vessel Energy Efficiency, Vigo, Spain, May 2010.
- Sterling, D. (1998) The Improvement of Prawn Trawling Performance Through Analysis of Otter Board Design and Operation, Masters thesis, Curtin University of Technology.
- Sterling, D. and Goldsworthy, L. (2007) Energy Efficient Fishing: A review, Part A - Alternative fuels and efficient engines, Australian Government, Fisheries Research and Development Corporation, Project No. 2005/239. Final Report.

- Stewart, P. A. M. and Ferro, R. S. T. (1987). "Four experiments investigating cod-end." *Fisheries Research* 5: 349-358.
- Stewart, P.A.M. and Mac Lennan, D.N. (1987) Fish capture process. In: *Fishing gear technology developments in Fisheries Research in Scotland*, Baily and Parrish (Eds): 282p.
- Stiles, M. L., Julie Stockbridge, Michelle Lande, Michael F. and Hirshfield (2010). *Impacts of Bottom Trawling on Fisheries, Tourism, and the Marine Environment*. http://oceana.org/sites/default/files/reports/Trawling_BZ_10may10_toAudrey.pdf
- Stone, M. (1989) Trends in Alaskan Pelagic trawls. In : *Proc. Of 1988 World symp. on fishing gear and fishing vessel design*: 321-325.
- Sukhatme, P.V. and Sukhatme, B.V. (1970) *Sampling Theory of Surveys with Applications*, Asia Publishing House, Calcutta.
- Sumaila, U. R., Cheung, W. W. L., and Rebuilding, L. (2007) HongKong's marine fisheries: an evaluation of management option. *Fisheries centre research reports*, 15(3). Fisheries Centre, University of British Columbia: Vancouver, Canada.
- Sumaila, U.R., Teh, L., Watson, R., Tyedmers, P. and Pauly, D. (2008) Fuel price increase, subsidies, overcapacity and resource sustainability. *ICES Journal of Marine Science*, 65: 832–840.
- Sumaila, U., Khan, A., Dyck, A., Watson, R., Munro, G., Tydemers, P. and Pauly, D. (2010) A bottom-up re-estimation of global fisheries subsidies. *Journal of Bioeconomics*, 12: 201–225.

- Sumpton, W.D., Smith, P.J. and Robothom, B.G. (1989) The influence of catch of monofilament and multifilament netting in otter prawn trawls. *Fish. Res.*, 8(1):35-44.
- Suuronen, P., Chopin, F., Glass, C., Løkkeborg, S., Matsushita, Y., Queirolo, D. and Rihan, D. (2012) Review Low impact and fuel efficient fishing— Looking beyond the horizon, *Fish. Res.*, 119 - 120:135 – 146.
- Swiniarski J., Nowakowski, P. and Sendlak, H. (1995) Now-a aparatura do badania modeli wlok6w [New equipment for testing trawl models]. *Bulletin of the Sea Fisheries Institute, Gdynia, No. 1: 61-67. (In Polish)*
- Tait, D. (1987) *The Effect of Knotless and Knotted Netting on the Drag of Demersal Trawl Nets*, Nova Scotia, Canada.
- Tait, D. (1989) The effect of knotless and knotted netting on the drag of demersal trawl. In: *Proceedings of the World Symposium on Fishing Gear and Fishing Vessel Design 1988*, Marine Institute, St. John's, Newfoundland, Canada, 119-131.
- Tait, D. (2001) comparison of the drag and fishing performance of two types of polyethylene netting. *Fishing News International - January 2001*. <http://www.crimond.com/comparison-drag-fishing-performanceof-two-types-polyethylene-netting>
- Takayama, S. and Koyama, T. (1959) Increasing the opening height of a trawl net by means of a kite. In: *Modern Fishing Gear of the World*, Kristjonsson, H. (Ed), Fishing News (Books) Ltd., London, 1: 185 — 195.
- Tauti, M. (1934) A Relation between Experiments on Model and on Full-scale of Fishing Net, *Nippon Suisan Gakkaishi*, vol. 3., 171-177.

- TERI (1999) TERI Energy Data Directory and Yearbook 1999-2000, Tata Energy Research Institute, New Delhi: 427 p.
- Thankappan, T. (2000) Ban on Trawling: An Accepted Practice for Marine Fisheries Management in Kerala, Kerala Calling, Department of Public Relations, Government of Kerala, 20 (12) 11-14.
- Theret, F. (1993) Etude de l'équilibre de surfaces réticulées placées dans un courant uniforme; application aux chaluts. PhD Thesis, Ecole Centrale de Nantes.
- Thomson, D. (1988) Conflict within the fishing industry, Naga, ICLARM Quarterly, July 1988, ISSN 116-290X: 3-4.
- Thrane, M. (2004a) Environmental impacts from Danish fish products – Hot spots and environmental policies, PhD dissertation, Department of Development and Planning, Aalborg University, Denmark, 510 p.
- Thrane, M. (2004b) Energy consumption in the Danish fishery. Identification of key factors. *Journal of Industrial Ecology*, 8:223–239.
- Thrane, M. (2006) LCA of Danish Fish Products. New methods and insights. *The International Journal of Life Cycle Assessment*, 11 (1): 66–74.
- Tietze, U., Lash, R., Thomsen, B. and Rihan, D. (2005) Economic Performance and Fishing Efficiency of Marine Capture Fisheries. FAO Fisheries Technical Paper. No 482. Rome, 68 pp.
- Traung, J.O. (Ed.) (1955) Fishing Boats of the World 1, Fishing News (Books) Ltd., London: 600 p.
- Traung, J.O. (Ed.) (1960) Fishing Boats of the World 2, Fishing News (Books) Ltd., London: 728 p.

- Traung, J.O. (Ed.) (1967) *Fishing Boats of the World 3*, Fishing News (Books) Ltd., London: 648 p.
- Tsukrov, I., Eroshkin, O. Fredriksson, D. Swift M.R. and Celikkol B. (2003) Finite element modeling of net panels using a consistent net element, *Ocean Engineering* 30, (2) 251-270.
- Tulay, E. and Smith, I.R. (1982) Costs and earnings of mini trawlers. In: Smith, LR. and Mines, A.N. (Eds.) *Small-scale Fisheries of San Miguel Bay, Philippines: Economics of Production and Marketing*, ICLARM Technical Report 8, Institute of Fisheries Development and Research, College of Fisheries, University of the Philippines in the Visayas, Quezon City, Philippines; IC LARM , Manila, Philippines; and the United Nations University, Tokyo, Japan, 64- 77.
- Tyedmers, P. (2000) *Salmon and Sustainability: The Biophysical Cost of Producing Salmon through the Commercial Salmon Fishery and the Intensive Salmon Culture Industry*. PhD Thesis, University of British Columbia, Vancouver, Canada.
- Tyedmers, P. (2001) Energy consumed by North Atlantic fisheries. In: *Fisheries' Impacts on North Atlantic Ecosystems: Catch, Effort and National/Regional Datasets*. Zeller, D., Watson, R. and Pauly, D. (eds.). Fisheries Centre, University of British Columbia, Vancouver, 12–34 p.
- Tyedmers, P. (2004) Fisheries and energy use. In: *Encyclopaedia of Energy*. Cleveland, C. (ed.). Elsevier, San Diego, vol. 2. 683–693 p.
- Tyedmers, P.H., Watson, R., and Pauly, D. (2005). Fueling Global Fishing Fleets. *Ambio*. 34 (8): 635-638.

- Tyedmers, P. and Parker, R.W.R. (2012) Fuel Consumption and Greenhouse gas, Emissions from Global Tuna Fisheries: A preliminary assessment. International Seafood Sustainability Foundation, results of a research project from School of Resource & Environmental Studies, Dalhousie University, Canada.
- Unal, V. M. (2004), Viability of the Trawl fishing Fleet in Foca (The Aegean sea) Turkey and some advises to Central and Management. Authority Bornnova, Turkey.
- Unnithan, G. R., Krishna, Iyer, H. and Srinivasa Rao, P. (1985). Economic analysis of 22m and 23m deep sea trawlers. *Fish. Technol.* 22 : 79-82.
- Unnithan, G.R., Gopal, N., Nair, V.R. and Nasser, M. (2005) Fuel consumption pattern by the mechanized fishing sector in Kerala. *Fish. Technol.* 42, 77-82.
- US Environmental Protection Agency (2014) Emission Factors for Greenhouse Gas Inventories.. p5. https://www.epa.gov/sites/production/files/2015-07/documents/emission-factors_2014.pdf.
- Valdemarsen, J. W. and Misund, O. A. (1995) Trawl designs and techniques used by Norwegian research vessels to sample fish in the pelagic zone. Institute of Marine Research, P.O.Box 1870, 5024 Bergen, Norway, 135-144
- Vijayan, V. and Baiju, M.V. (2006) Net Drag Estimation of 18.0 m Semi Pelagic Trawl through Calculated Twine Area in Comparison to Projected Prototype Values by Model Studies. *Fish. Technol.* 43 (1), 37p.
- Venkatesan V., Alloycious, P. S., Sajikumar, K. K., Jestin Joy K.M., Sheela, P. P. and Mohamed, K. S. (2015) Checklist of marine bivalves and gastropods off Kollam, Kerala. *Mar. Fish. Infor. Serv., T & E Ser.*, No. 225: 16-19.

- Vázquez-Rowe, I., Moreira, M.T. and Feijoo, G. (2010) Life cycle assessment of horse mackerel fisheries in Galicia (NW Spain). Comparative analysis of two major fishing methods. *Fish. Res.*, 106 (3): 517–527.
- Vázquez-Rowe, I., Moreira, M. T. & Feijoo, G. (2011). Life cycle assessment of fresh hake fillets captured by the Galician fleet in the northern stock. *Fish. Res.*, 110: 128-135.
- Vázquez-Rowe, I., Hospido, A., Moreira, M.T. and Feijoo, G. (2012). Best practices in Life Cycle Assessment implementation in fisheries: improving and broadening environmental assessment for seafood production systems. *Trends in Food Science and Technology*, 28: 116-131.
- Vázquez-Rowe, I., Villanueva-Rey, P., Moreira, M.T. and Feijoo, G. (2014) A review of energy use and greenhouse gas emissions from Worldwide hake fishing. In: *Assessment of Carbon Footprint in Different Industrial Sectors*, (Ed: Muthu, S.S.), 2, (1) 29p.
- Vergheese, C. P. (1998) Capture Fishery Technology in India. In: Hameed, M. S., Kurup, B. M., (Eds.) *Technological Advancements in Fisheries*, Publ. No. 1. School Ind. Fish, 161-165.
- Vijayan, V., Varghese, M.D., George, V.C. and Unnithan, G.R. (1990) Evolution of an improved trawl for traditional motorised craft, *Fish. Technol.* 27: 83-86.
- Vijayan, V., Mathai, T.J., Mhalathkar, H.L.N. and Abbas, M.S. (1992) Advantages of large meshes in midwater trawl. *Fish. Technol.*, 29(1): 5-8.
- Vijayan, V., Manoharadoss, R.S. and Cubelio, S.C. (2003) Target specific 51 m long wing semi-pelagic trawl for effective off-bottom fishing in Indian EEZ, *Fish. Technol.* 40: 24-27.

- Vijayan, K.V., Jayasankar, P. and Vijayagopal, P. (eds.) (2007) Indian Fisheries A Progressive Outlook. Central Marine Fisheries Research Institute, Kochi, 203 p.
- Vivekanandan, E., Singh, V. V. and Kizhakudan, J. K. (2013) Carbon footprint by marine fishing boats of India. *Current Science*, 105(3): 361–366.
- Wakeford, J (1994) The Effect of Frame line Tapers on the Engineering Performance of Prawn Trawl Systems, Australian Maritime College, Launceston.
- Ward, N., Montgomerie, M. and Lart, W. (2005) Fuel efficiency trials using Jackson trawls with reduced twine diameter on MFV Challenge II Seafish Report No. SR578, 31p.
- Wardle, C.S. (1976) Fish reactions to fishing gears. *Scottish Fisheries Bulletin* (43), 16-20.
- Warner, W. W. (1998) Distant Water: The fate of North Atlantic Fisherman, Penguin Books Ltd., Middlesex, England.
- Watanabe, H. and Okubo, M. (1989) Energy input in marine fisheries of Japan, *Bull. Jap. Soc. Sci. Fish.* 55(1): 25-33.
- Watanabe, H. and Uchida, I. (1984) An estimation of direct and indirect energy input in fish catch for fish paste products, *Bull. Jap. Soc. Sci. Fish. Nissuishi.* 50(3): 417-423.
- Watson, J.W. (1989) Fish behaviour and trawl design, Potential for selective trawl. In: Proc. of the 1988 world Symp. On Fishing Gear and Fishing Vessel Design: 25-29.

- Wiedmann, T. and Minx, J. A. (2008) Definition of ‘carbon footprint’. In: Pertsova CC, editor. Ecological economics research trends. Hauppauge NY, USA: Nova Science Publishers; 1–11.
- Wigan, M. (1998) The last of the hunter gatherers, Swan Hill Press. ISBN 1-85310-771-9.
- Wileman, D.A. (1984) Project Oiljish - Investigation of the Resistance of Trawl Gear, Dansk Fiskeriteknologisk Inst., Hirtshals, Denmark: 127 p.
- Winther, U., Ziegler, F., Skontorp Hognes, E., Emanuelsson, A., Sund, V. and Ellingsen, H. (2009) Carbon footprint and energy use of Norwegian seafood products. SINTEF Report Nr. SHF80 A096068, 91 p.
- Wiviott, D.J. and Mathews, S.B. (1975) Energy efficiency comparison between the Washington and Japanese otter trawl fisheries of the northeast Pacific. *Marine Fisheries Review*, 37 (4): 21–24.
- World Bank (2008) The sunken billions. The economic justification for fisheries reform. Agriculture and Rural Development Department. Washington, D C: The World Bank, 130p. DOI: 10.1596/978-0-8213-7790-1.
- Wray, T. (1986) V—door variants are tested by Danish Institute. *Fish. News. Int.*, 25(2): 30 - 31.
- Wray, T. (1990) Y- design revolution underway. *Fish. News. Int.*, 29(1): 16-17.
- Xavier, S. (2013) Economic sustainability of the trawl Fishery of Kerala, Ph. D Thesis. Mahatma Gandhi University, Kottayam, 230 p.
- Yang, L. (1988) Some considerations on the measures for saving energy of bottom trawl operated by otter trawler. *Mar. Fish. Haiyang. Yuye.*, 10(2): 60-63.

- Ziegler, F. and Hansson, P.A. (2003). Emissions from fuel combustion in Swedish cod fishery. *Journal of Cleaner Production*. 11: 303–314.
- Ziegler, F., Nilsson, P., Mattsson, B. and Walther, Y. (2003) Life cycle assessment of frozen cod fillets including fishery-specific environmental impacts. *The International Journal of Life Cycle Assessment*, 8(1):39–47.
- Ziegler, F. and Valentinsson, D. (2008) Environmental life cycle assessment of Norway lobster (*Nephrops norvegicus*) caught along the Swedish west coast by creels and conventional trawls—LCA methodology with case study. *The International Journal of Life Cycle Assessment*, 13 (6): 487– 497.
- Ziegler, F., Eichelsheim, J., Emanuelsson, A., Flysjö, A., Ndiaye, V. and Thrane, M. (2009) Life cycle assessment of southern pink shrimp products from Senegal - an environmental comparison between artisanal fisheries in the Casamance region and a trawl fishery based in dakar. Göteborg, SIK.
- Ziegler, F., Winther, U., Skontorp Hognes, E., Emanuelsson, A., Sund, V. and Ellingsen, H. (2012) The carbon footprint of Norwegian seafood products on the global seafood market. *J. Ind. Ecol.* 17 (1), 103–116.



PUBLICATIONS

Research papers

- [1] Sayana, K.A., Ramesan, M.P., Madhu, V.R., Pravin, P. and Edwin, L. (2016) Appraisal of trawl design operated along Kerala coast. Fish. Technol. 53: 30-36.
- [2] Muhammed Sherief, P. S., Sreejith, P. T., Sayana, K. A., Dhiju Das P. H., Saly N. Thomas, Remesan M. P. and Leela Edwin (2015) Drift Gillnets made of Sapphire[®] and Polyamide in Gujarat, India. Fish. Technol 52 : 62 – 66
- [3] Sayana K. A., Remesan M. P. and Edwin L. (2018) Impact of operational parameters on drag of trawl nets Fish. Technol (under review)

Books

- [1] Pravin P., Leela Edwin, Remesan M. P., Madhu V. R., Baiju M. V., Saly N Thomas, Aravind S. Kalangutkar and Sayana K. A. (2017) CIFT Fishing Systems Catalogue 8- Mechanised marine fishing systems: Karnataka and Goa, Central Institute of Fisheries Technology, Kochi: p.

Popular article

- [1] Remesan M.P., Madhu V.R., Sayana K.A., Prabeeshkumar, M.V., Harikrishnan K.R. and Edwin L. (2017). Fuel saving through material substitution in trawls. Fish Tech Reporter 3(1):3-5



Appraisal of Trawl Designs Operated Along Kerala Coast

K. A. Sayana*, M. P. Remesan, V. R. Madhu, P. Pravin and Leela Edwin

ICAR-Central Institute of Fisheries Technology, P.O. Matsyapuri, Cochin - 682 029, India

Abstract

This study presents the design details of trawl nets being operated along Kerala coast. Trawls operated in Kerala can be grouped as fish trawl, shrimp trawl, cephalopod trawl and gastropod trawl based on target catch. The head rope length of different trawls ranged from 39.6 to 81.0 m. The mesh size of codends were in the range of 16-25 mm. Majority of the trawlers in Kerala use V-form steel otter boards and the smaller boats use wooden flat rectangular boards. A trend in increasing the mesh size of fish trawls at the wing to about 5000 mm was observed.

Key words: Trawl net, designs, mesh size, Kerala

Introduction

Trawl is one of the most popular fishing gears of Kerala and there are 29, 241 trawlers operated from different fishing harbours of the State (CMFRI, 2012). Since its introduction, changes have taken place in the size, design, type of material and operation (Thankappan, 2000). The race for fish has resulted in increasing the size of the trawlers, engine power and the size of trawl nets. Though there was a significant increase in size of trawl and mesh size in wing region, the codend mesh size remained below 30 mm (Edwin et al., 2014).

Periodic evaluation and bench marking of existing commercial trawl designs are required for assessing the energy requirements and to suggest improvements for gear based conservation measures. There are only limited studies on the commercial trawl designs operated along Kerala. Mukundan & Hameed (1993), Neethiselvan & Brucelee (2003), Gibinkumar et al. (2005) and Rajeswari et al. (2012)

Received 26 September 2015; Revised 02 November 2015 ; Accepted 29 December 2015

*E-mail: sayanaanandan@gmail.com

© 2016 Society of Fisheries Technologists (India)

studied the design of trawls operated along different coasts. Pravin et al. (2012) reported the large mesh demersal trawls in India and in 2013 compiled different trawl designs developed by Central Institute of Fisheries Technology (CIFT). In this paper, design, technical and operation details of trawl nets used along Kerala coast are presented.

Materials and Methods

The study was undertaken along the fishing harbours/landing centres of nine maritime districts of Kerala during 2012-13. Design details of trawl nets were randomly collected from fishermen, net makers, boat owners, etc. using structured and pre-tested questionnaire. Measurement of trawl dimensions of different designs were measured randomly.

Results and Discussion

A total of 63 trawl designs were studied and documentation of gear designs were done according to FAO guidelines (FAO, 1975; 1978). Based on the target groups, trawl nets along Kerala coast were categorised into four types *viz.*, fish trawls, shrimp trawls, cephalopod trawls and gastropod trawls. Irrespective of the target catch and depth of operation, trawl nets in Kerala were predominantly two seam; four seam trawls were rarely used.

Head rope length of fish trawls along Kerala coast varied from 39.6 - 81.0 m. Polypropylene ropes with 12 - 16 mm diameter were used for head rope and foot rope. HDPE multi filament twisted twines of 0.5 to 4.0 mm diameter were used for the netting. Large mesh fish trawls with a wing end mesh size up to 5000 mm are now popular in the sector and the codend mesh size varied from 16 - 25 mm. Designs of most common fish trawls in the State are given in Fig.1 to Fig.7. Ribbonfish, pomfret, croakers, threadfins, horse mackerel, polynemids, catfish, barracuda, lizardfish, carangids, mackerel, anchovies, false trevally, and flatfish are the major finfish targeted by fish trawls (CMFRI, 2015).

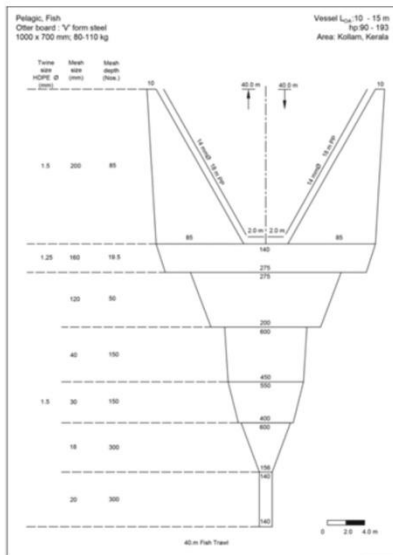

Fig. 1. 40.0 m Fish trawl

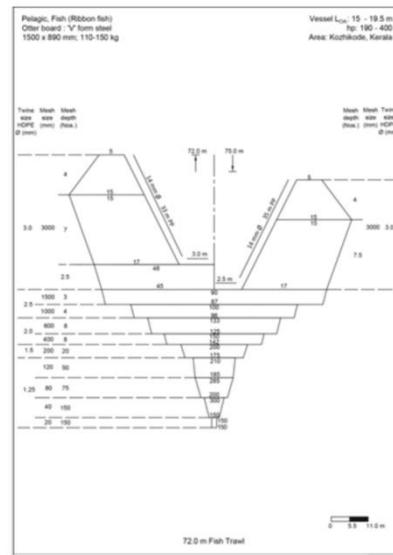

Fig. 3. 72.0 m fish trawl

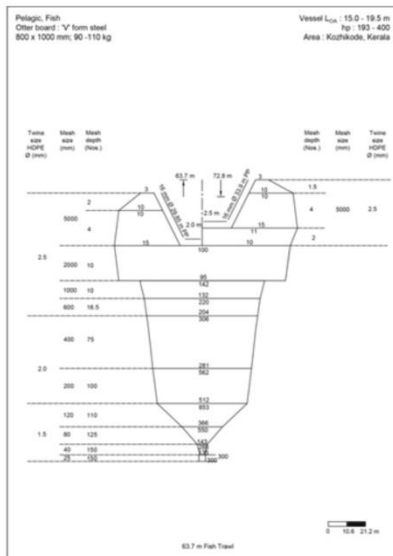

Fig. 2. 63.7 m Fish trawl

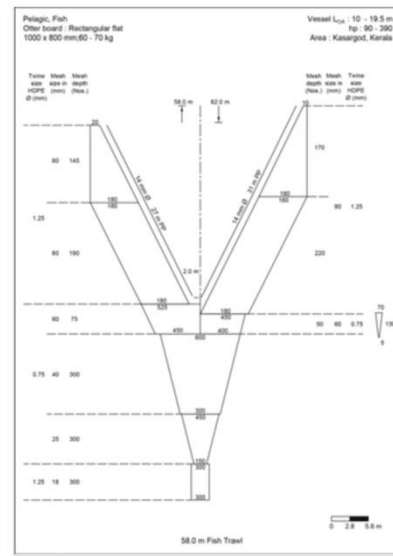

Fig. 4. 39.6 m fish trawl

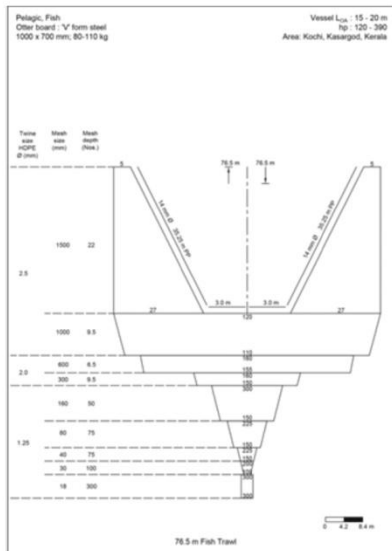

Fig. 5. 76.5 m fish trawl

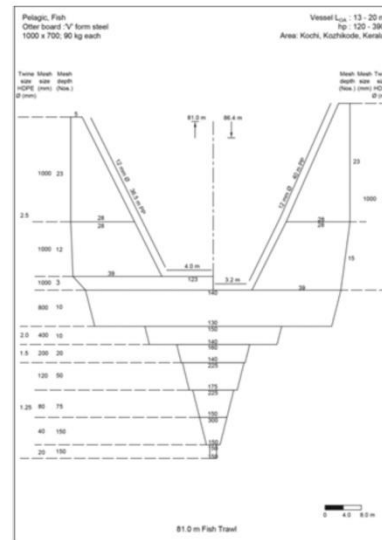

Fig. 7. 81.0 m fish trawl

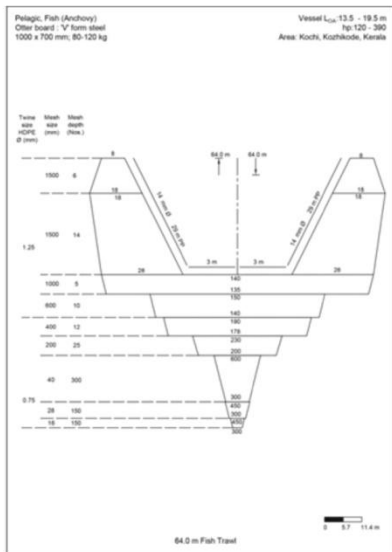

Fig. 6. 64.0 m fish trawl

Though not as diverse as fish trawls, shrimp trawls with different designs were recorded. The head rope length of shrimp trawls along Kerala coast ranged from 34.2 – 58.0 m. Polypropylene rope with 10 - 12 mm diameter were used as head rope and foot rope. HDPE twines with 0.5 - 2.5 mm diameter were used for fabrication of the trawl. Mesh size of the shrimp trawl at the wing end varied from 40 - 300 mm and 18 - 25 mm for codend and HDPE twines with 0.5 – 2.5 mm diameter were extensively used. Typical shrimp trawl designs in Kerala are given in Fig. 8 to Fig. 11. *Metapenaeus dobsoni* and *Parapenaeopsis stylifera* are the major shrimp catch from Kerala coast.

The use of squid and cuttlefish trawls is seasonal and was recorded from all the fishing harbours of the State. The head rope length of these trawls ranged from 54.0-57.6m and are fabricated with HDPE webbing of diameter between 1.25-2.5 mm. The mesh size of 1000-1200 mm in the wing region scales down to 18-20 mm in the codend. PP rope of diameter between 12-14 mm were used for the head and foot ropes. Typical designs of cephalopod trawls operated along Kerala coast are given in Fig. 12 and 13 respectively. *Loligo duvauceli*, *Sepiella inermis* and *S. pharaonis* are the major cephalopod species targeted by these trawls.

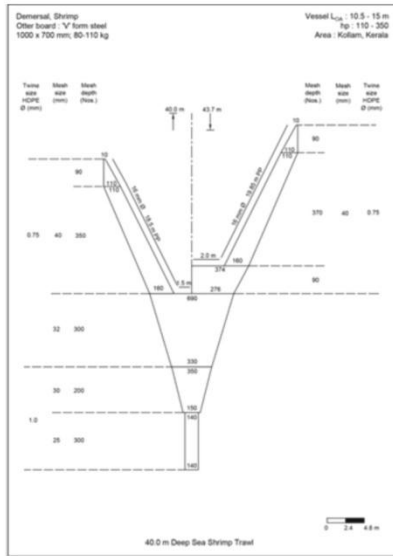

Fig. 8. 40.0 m shrimp trawl

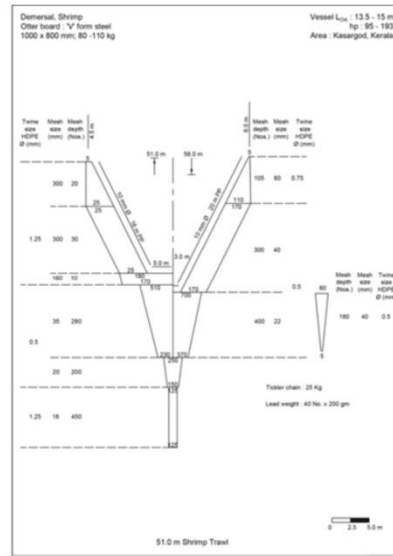

Fig. 10. 51.0 m shrimp trawl

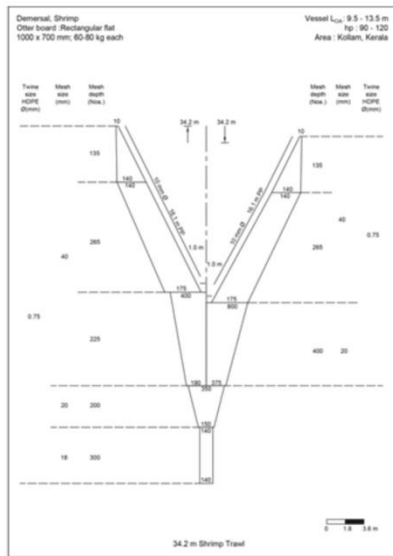

Fig. 9. 34.2 m shrimp trawl

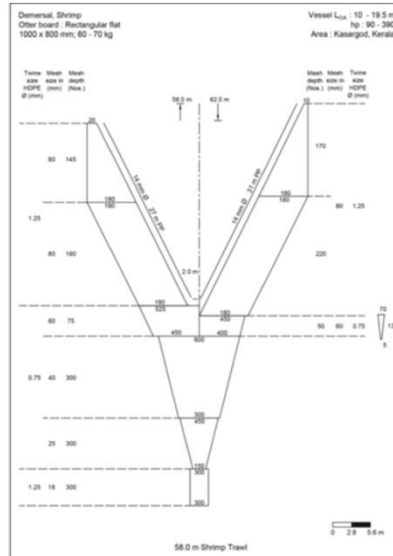

Fig. 11. 58.0 m shrimp trawl

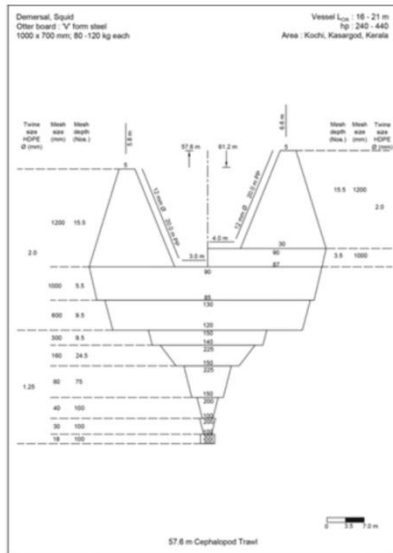

Fig. 12. 57.6 m Cephalopod trawl

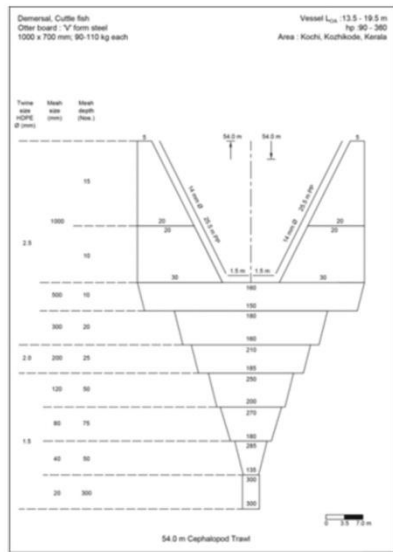

Fig. 13. 54.0 m Cephalopod trawl

Design and operational details of Gastropod trawls are almost similar to shrimp trawls. These trawls are operated along Kollam coast only. The wing end mesh size ranged from 40-80 mm and the codend mesh size was 20 mm. The targeted species are *Babylonia zeylanica* and *B. spirata*. The typical design of gastropod trawl being operated off Kollam coast is given in Fig. 14.

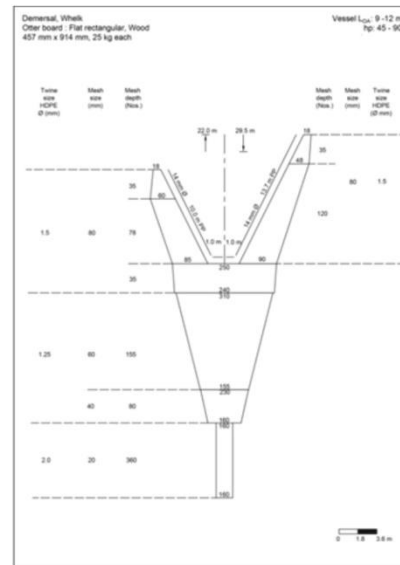

Fig. 14. 22.0 m Gastropod trawl

HDPE or Acrylonitrile Butadiene Styrene (ABS) floats are commonly used with one master float with diameter of 200-350 mm used at the centre and 10-17 floats with diameter of 75-100 mm used on either sides of the master float. Recently only 3-4 large floats of 800 mm diameter are attached to the head rope with a small rope. Along Kerala coast for a trawl net having 11.0 m head rope length used seven plastic floats of 100 mm diameter (Boopendranath & Hameed, 2013). According to Rajeswari et al., 2012, in Andhra coast fish trawls used 15-305 mm Ø spherical plastic floats of which the number varied from five to seventeen.

Lead or iron chain used as sinkers are spherical or spindle shaped with weight ranging from 100-250 g

Table 1. Specifications of trawl nets from Kerala

Item and Specification	Fish trawl	Shrimp trawl	Cephalopod trawl	Gastropod trawl
Head rope length (m)	39.6.0 – 81.0	34.0 – 58.0	50-65	22
Webbing material	High Density Polyethylene (HDPE)			
Twine size (mm)	0.5 – 3.0	0.5 – 2.5	1.5 – 2.5	1.25 – 2
Wing end mesh size (mm)	40 – 5000	40 – 300	1000 – 1200	80
Codend mesh size (mm)	16 – 25	18 – 25	18 – 20	20
Rope material	Poly Propylene (PP)			
Rope diameter (mm)		12 – 16		14

each. A total of 30-80 kg of sinkers are used, depending on the size of the gear. According to Boopendranath & Hameed (2013), seven kg of iron link chain was used as sinker for 11.0 m trawl. Two polypropylene ropes of 20 - 40 m length and 18 - 22 mm diameter were used as bridles. According to Mohan et al. (1990), 30 m bridle for 25 m high opening trawl and 20 m bridle for 32 m large mesh trawl was found to be effective based on comparative catch rates obtained.

V- form steel otterboards were the most common, but smaller trawlers continue to use wooden flat rectangular boards. According to Gibinkumar et al. (2005) 'V' form steel otter boards of 50 - 85 kg each were used in 80% of the trawlers in Kerala. Large trawlers use steel otterboards each weighing 80 -150 kg and the weight of wooden boards ranged from 25 kg to 40 kg each.

Irrespective of the designs of trawls operated, bycatch was identified as the most important problem. Pramod (2010) estimated the bycatch and discards from Indian EEZ as 1.2 million t. The bycatch from Kerala coast comprised of juveniles of commercially important species, stomatopods, crabs, echinoderms and jellyfishes (Kurup et al., 2003). According to Gibinkumar et al. (2005) juveniles of more than 200 species of commercially important finfish and shellfish are landed as bycatch along south-west coast of India. None of the trawl designs studied adopted the Kerala Marine Fisheries Regulation Act stipulated codend mesh size of 35 mm. A five time increase in wing end mesh size and three times increase in head rope length was observed in the trawl designs when compared to the study by Sabu et al. (2005). Adoption of responsible fishing systems like

semi-pelagic trawl system (CIFT, 2011) for selective harvesting of fish needs to be popularized for minimizing the impacts of trawling on ecosystem and the resources.

The findings of the study will help as a benchmark for determining the changes in the fishing power and also to introduce gear based technical measures for conservation of trawl resources.

Acknowledgements

The authors gratefully acknowledge the support from the National Agricultural Science Fund (NASF) for funding this study. They also thank, Director, CIFT for the facilities provided and for his kind encouragement and support during the course of the study.

Reference

- Boopendranath, M. R. and Shahul Hameed, M. (2013) Energy Analysis of Mini-trawl Operations, off Cochin, Kerala, India, Fish. Technol. 50(4) 289-293 CIFT 2007. Responsible Fishing - Contributions of CIFT. CIFT Golden Jubilee Series. Central Institute of Fisheries Technology, Cochin, 46 p
- CIFT (2011) Central Institute of Fisheries Technology Semi-Pelagic Trawl System: An Ecofriendly Alternative to Bottom Trawling for Smallscale Mechanised Sector (Boopendranath, M.R., Remesan, M.P., Pravin, M.P. and Madhu, V.R., Eds). CIFT Technology Advisory Series. Central Institute of Fisheries Technology, Cochin, 16 p
- CMFRI (2012) Marine Fisheries Census 2010: Kerala. Part II: 6. Department of Animal Husbandry, Dairying and Fisheries, New Delhi; Central Marine Fisheries Research Institute, Kochi: 199p
- CMFRI (2015) Annual Report 2014-15. Central Marine Fisheries Research Institute, Cochin, 353 p

- Edwin, L., Thomas, S. N., Pravin, P., Remesan, M. P., Madhu, V. R., Thomas, S. N., Baiju, M.V., Sreejith, P. T., Ravi, R., Das, D.P.H. (2014) CIFT Fishing Systems: Kerala, Central Institute of Fisheries Technology, Kochi: 113 p
- FAO (1975) FAO Catalogue of small-scale fishing gear. Fishing News Books Ltd., Farnham
- FAO (1978) FAO Catalogue of fishing gear designs. Fishing News Books Ltd., Farnham
- Gibinkumar, T.R., Sabu, S., Pravin, P., Boopendranath, M. R. (2005) Trawling systems operated off Quilon, Kerala, India. In: International symposium on Improved sustainability of fish production systems and appropriate technologies for utilization (Kurup, B.M. and Ravindran, K. Eds), 16-18 March, 2005, Cochin, India. pp 462-481
- Kurup, B. M., Premlal, P., Thomas, J. V. and Vijay Anand (2003) Bottom trawl discards along Kerala coast: A case study. J. Mar. Biol. Assoc. India, 45, 99-107
- Mohan Rajan, K. V., Boopendranath, M. R., George Mathai P. and Subramonia Pillai, N. (1990) Studies on optimisation of bridle lengths for demersal trawls. Fish. Technol. 27: 87-91
- Mukundan, M. and Hameed, M.S. (1993) Present status of trawl designs in Cochin area. J. Mar. Biol. Assoc. India. 35 (1 & 2) 109-113
- Neethiselvan, N. and Brucelee, G. (2003) Analysis of design features of fish trawls and shrimp trawls of Thoothukkudi Coast. Fish. Technol. 40(1): 18-23
- Pramod, G. (2010) Illegal, Unreported and Unregulated Marine Fish Catches in the Indian Exclusive Economic Zone, Field Report (Pitcher, T.J., Ed), 29 p, Policy and Ecosystem Restoration in Fisheries, Fisheries Centre, University of British Columbia, BC, Vancouver, Canada
- Pravin, P., Madhu, V. R., Remesan, M. P., Baiju, M. V. and Boopendranath, M. R. (2012) Large mesh demersal trawls in India: An update. Fishing Chimes 32(5): 43-45p
- Rajeswari, G., Raghu Prakash, R. and Sreedhar, U. (2012) Trawl Designs Used in Small-scale Mechanised Fisheries Sector of Andhra Pradesh, India, Fishery Technology, vol. 49(1) 18-27
- Sabu, S., Gibinkumar, T.R., Pravin, P., Boopendranath, M.R. (2005) Trawl for whelk (*Babylonia spirata*) off Quilon, Kerala, India. In: International Symposium on Improved Sustainability of Fish Production Systems and Appropriate Technologies for Utilization (Kurup, B.M. and Ravindran, K., Eds), 16-18 March, 2005, Cochin, India. pp 496-501
- Thankappan, T. (2000) Ban on trawling: An accepted practice for marine fisheries management in Kerala, Kerala Calling, Department of Public Relations, Government of Kerala. 20(12) 11-14



Research Note

Drift Gillnets made of Sapphire® and Polyamide in Gujarat, India

P. S. Muhammed Sherief* P. T. Sreejith, K. A. Sayana, P. H. Dhiju Das, Saly N. Thomas, M. P. Remesan and Leela Edwin

Central Institute of Fisheries Technology, P. O. Matsyapuri, Cochin - 682 029, India

Drift gillnets are used mainly in high seas to catch large pelagic species like seerfish, tuna, sailfish, swordfish and shark and fleet length of up to 10 000 m are reported (Thomas, 2010). In drift gillnetting, the net is freely allowed to drift in water along with the vessel. A total of 20 257 mechanized gillnetters are operated in the Indian waters (CMFRI, 2012).

Large mesh gillnets were successfully introduced along the east coast of India as part of Bay of Bengal Programme (Pajot, 1993). Chaidee et al. (2007) effectively used drift gillnets for marine resource surveys in Bay of Bengal. Large mesh drift gillnetting was introduced in Lakshadweep water by Pravin et al. (2009). Large mesh gillnets are widely operated in Gujarat (Pravin et al., 1998; Thomas et al., 2005). Conventionally, Polyamide (PA) multifilament was used for fabrication of large mesh gillnets in India which was gradually replaced by high density polyethylene (HDPE) in few states like Andhra Pradesh, Tamil Nadu and Gujarat (Pillai, 1989; Pravin et al., 1998; Rao et al., 2002; Thomas & Hridayanathan, 2002). Pillai (1989) and Pravin et al. (1998) reported that, HDPE was widely used as gillnet material in Gujarat. Material substitution of large mesh nylon gillnets by HDPE gillnets in Kerala has been attempted by Thomas & Hridayanathan (2002). Sapphire®, a modified form of HDPE was reported to be used for fabrication of trawl nets (Councilman et al., 2011; Edwin et al., 2014). Recently the material was found to be used for large mesh gillnets in India.

Received 26 April 2014; Revised 12 November 2014; Accepted 14 November 2014

* E-mail: sheriefmuhammed@gmail.com

© 2015 Society of Fisheries Technologists (India)

There are 28 400 fishing crafts in Gujarat state, of which 2 964 are mechanized gillnetters (CMFRI, 2012). These vessels operate gillnets made of PA and HDPE. In some areas of Gujarat like Mangrol, gillnets made of Sapphire® netting (Garware-Wall Ropes Ltd., Pune, India) have been introduced recently. There are no reports from India, regarding the use of Sapphire® for fabrication of gillnets. The aim of the study was to document the design and structural details of large mesh drift gillnets made of Sapphire® and compare it with the conventional polyamide multifilament gillnets used in the state.

Data was collected during January - February 2013 from the Mangrol fishing harbour using structured questionnaire covering details of fishing vessel and fishing gear. The details were recorded as per Sreekrishna & Shenoy (2001) and Thomas & Hridayanathan (2002). Design details were depicted as per Nedelec (1975).

Detailed specification of large mesh drift gillnets made of Sapphire® and PA are given in Table 1 and their designs are given in Fig. 1 and 2 respectively. Both Sapphire® and PA gillnets were made of 170 mm mesh size webbing. However, Sapphire® gillnet webbing was of thicker twine (1.7 mm Ø, 380x10x3) than PA webbing (1.25 mm Ø, 210x6x3). The lower breaking strength of netting is compensated by the use of thicker twines (Beverton et al., 1993). A major difference between the two nets was that Sapphire® gillnets were rigged with foot rope and sinkers while PA gillnet did not have foot rope and sinkers. This is to adjust the lower specific gravity of Sapphire® material (Councilman et al., 2011). Pajot (1980), used disc shaped concrete sinkers, of approximately 250 g in large mesh drift gillnet made of PE multifilament. According to Chaidee et al.

(2007) sinkers in large mesh drift gillnets help the net expand fully while in operation.

PA gillnets generally are rigged without foot rope for better entangling when targeting fast swimming large pelagics (Thomas & Hridayanathan, 2006). In Sapphire® nets lower hanging coefficient is used for rigging to have better entangling effect, (Table 1).

Both types of nets are operated from mechanized wooden gillnetters of 12-18 m L_{OA} fitted with 120 hp engine. Earlier, the depth of operations of large mesh gillnets were limited to 100 m in India (Thomas, 2001) but at present it ranges from 100-1500 m. Similar observation was reported by Akhlesh et al. (2012). Gillnetters are equipped with electronic instruments like GPS, Echosounder and VHF transceivers. The main fishing season is from September to March and peak catch was observed during January. One end of the net was tied to the vessel and the net was freely allowed to drift along with the boat for 4-6 h during night. Indicator lights are attached to the two ends of the net during night operation. Duration of fishing voyage which was about two weeks in late 1990s, now extends up to 20-30 days (Edwin et al., 2014).

The targeted species of large mesh gillnets are tunas (*Thunnus albacares*, *Katsuwonus pelamis*, *Auxis thazard*, *Thunnus tonggol*), seerfish (*Scomberomorus commersonii*), cobia (*Rachycentron canadum*), sharks (*Carcharinus* spp., *Rhizoprionodon* spp., *Alopias* spp. and *Scoliodon* spp.) and bill fishes (*Istiopax indica* and *Istiophorous platypeterus*). Studies with the large mesh gillnets showed that, it is an effective fishing method for exploiting large pelagic fish species found in the high seas (Pravin et al., 2009).

Use of Sapphire® as gillnet material gives advantages like better abrasion and knot stability than other gear materials (Councilman et al., 2011). Fishermen opined that, Sapphire® was more durable than PA and HDPE and that being lighter than PA, Sapphire® net can be operated very easily. (Nielson et al., 1983) reported that braided twines of sapphire® netting gave better durability and abrasion resistance than twisted twine of nylon in trawl nets.

Though many advantages were cited by the fishers for the Sapphire® netting, data on comparative fishing performance with net made of other materials are lacking. In this context, the information provided on design, structural parameters and operation of large mesh pelagic drift gillnets made

Table 1. Details of Sapphire®/ Polyamide drift gillnets operated in Mangrol, Gujarat

Main webbing	Sapphire®	Polyamide (PA)
Mesh size (mm)	170	170
Twine type	Twisted monofilament	Multifilament twine
Twine specification/Diameter (mm)	1.7 (380Dx10x3)	1.25 (210Dx6x3)
Colour of webbing	Dark blue with yellow	White
Hanging coefficient (E)	0.42-0.55	0.50-0.60
No of meshes in length/unit	840-1000	352-730
No. of meshes in depth	100-120	85-100
Head rope material	Polypropylene	Polypropylene
Head rope size (mm)	8	6
Foot rope size (mm)	8	Nil
Float material	Thermocol piece	PVC
Float size (mm)	285x220 (LxB)	100x50
Sinker material/ weight (g)	Cement disc-250g	Nil
Sinker size (mm)	100x25	Nil
Total fleet length (m)	6000-8000	3000-5000

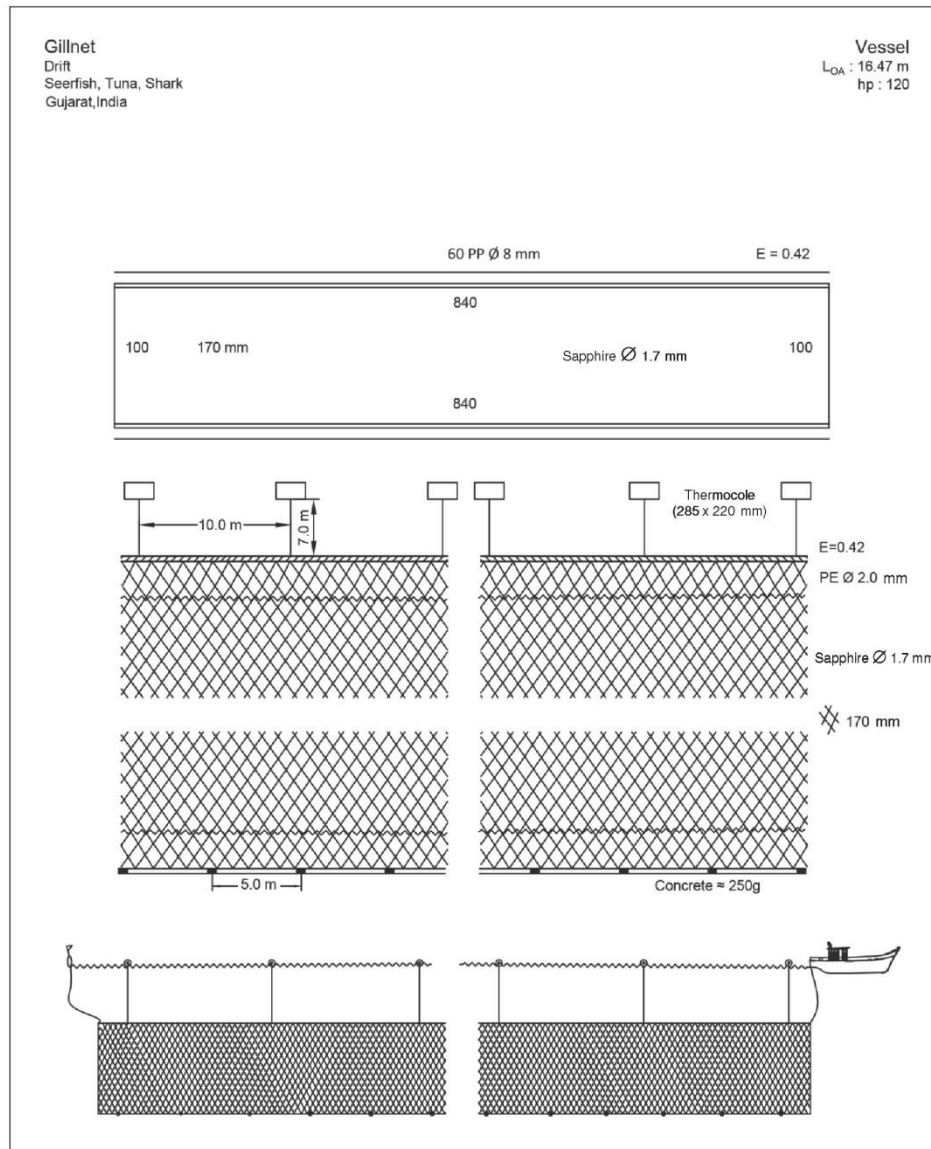

Fig. 1. Design of a typical Sapphire® drift gillnet

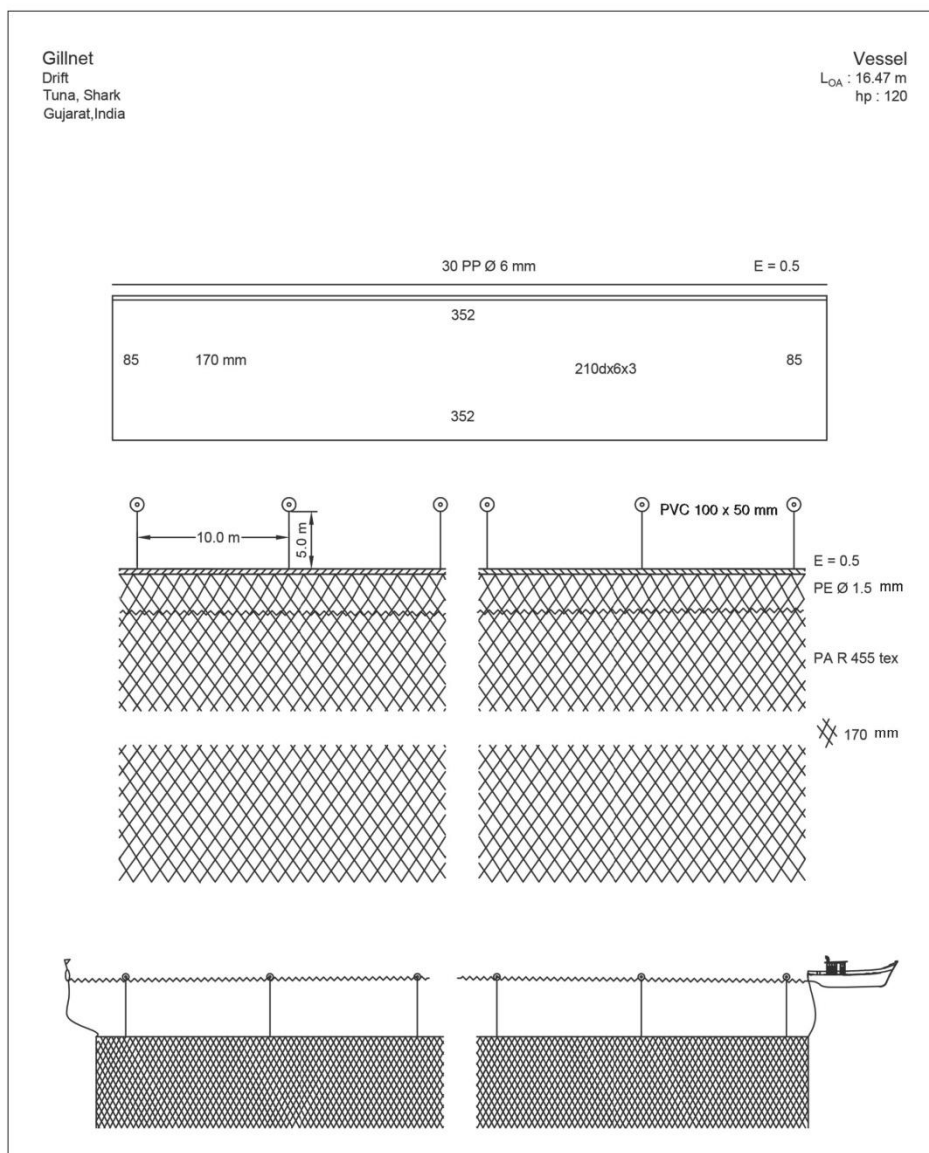

Fig. 2. Design of a typical Polyamide drift gillnet

of Sapphire® netting would serve as baseline data for future studies. Performance evaluation in relation to other materials as well as cost effectiveness and durability need to be worked out for recommending sapphire as a suitable material for large mesh drift gillnets.

Acknowledgment

The authors gratefully acknowledge the support from the National Fund for Basic, Strategic and Frontier Application Research in Agriculture (NFBSFARA), for funding this study. They also thank, Director, CIFT for the facilities provided and for his kind encouragement and guidance during the course of the study. Help and technical assistance from Shri. H. V Pungera, Senior Technical Assistant, Veraval Research Center of CIFT is greatly acknowledged.

References

- Akhilesh, K. V., Ganga, U., Pillai, N. G. K., Vivekanandan, E., Bineesh, K. K., Rajool Shanis, C. P. and Manjebayakath, H. (2011) Deep sea fishing for Chondrichthian resources and sustainability concerns-a case study from Southwest coast of India. *Indian J. Geo-Mar. Sci.* 40(3) pp 347-355
- Beverton, Raymond J. H., Holt, Sidney J. (1993) On the Dynamics of Exploited fish populations. *Fish. Fish.* Vol. 11. 538 p
- Chaidee, P., Darumas, N., Chamasont, O., Sada, M. N., Jayasinghe, R. P. K., Chinthaka, K. S. D., Sein, A. W., Nalla, J. and Thapanand-Chaidee, T. (2007) Marine Resource Surveys by Drift gillnet in the Bay of Bengal. pp 149-166
- CMFRI (2012) Marine Fisheries Census 2010 Part I India, Department of Animal Husbandry, Dairying and Fisheries and Central Marine Fisheries Research Institute, Cochin 98 p
- Councilman, C. J. Walstrum, Matt Rhodes and Jacobs. J. (2011) MDNR-NOAA Trawl Standardization Study. NOAA Technical Memorandum NOS NCCOS 126. NOAA National Centers for Coastal Ocean Science, Center for Coastal Environmental Health and Biomolecular Research, Cooperative Oxford Laboratory, Oxford, MD. 17 p
- Edwin L., Pravin, P., Madhu, V. R., Thomas, S. N., Ramesan, M. P., Baiju, M. V., Ravi, R., Das, D. P. H., Boopendranath M. R and Meenakumari. B (2014) Mechanised Marine Fishing Systems: India. 225 p, Central Institute of Fisheries Technology, Cochin
- Jayaprakash, A. A. and Pillai, N. G. K. and Elayathu, M. N. K. (2002) Drift gill net fishery for large pelagics at Cochin - A case study on by-catch of pelagic sharks. In: Management of Scombroid Fisheries (Pillai, N. G. K., Menon, N. G., Pillai, P. P. and Ganga, U., Eds), pp 155-164, Central Marine Fisheries Research Institute, Cochin
- Nedelec, C. (1975) FAO Catalogue of Small Scale Fishing Gear, Fishing News (Books) Ltd., Farnham, Surrey, England, 191 p
- Nielsen, L. and Johnson D. (1983) Fisheries Techniques, 468 p American Fisheries Society, Southern Printing Company, Blacksburg, Virginia
- Pajot, G. (1980) Improvement of large mesh drift net for small scale fisheries of Sri Lanka, BOBP News No.9p
- Pajot, G. (1993) Large pelagic fishing in India, BOBP News No. 51, pp 18-20
- Pillai, N. S., Boopendranath, M. R. and Kunjipalu, K. K. (1989) Studies on the suitability of HDPE material for Gillnets, *Fish. Technol.* 26: 1-3
- Pravin, P., Remesan, M. P. and George Mathai, P. (1998) Gillnet fishing in Gujarat. In: Advances and Priorities in Fisheries Technology, (Balachandran, K. K., Iyer, T. S. G., Madhavan, P., Joseph, J., Perigreen, P. A., Raghunath, M. R. and Varghese, M. D., Eds), pp 170-176, Society of Fisheries Technologists (India), Cochin
- Pravin, P., Saly N. Thomas, P. George Mathai, B. Meenakumari and M. P. Remesan (2009) Studies on Drift Gillnet Fishing at Agatti Island (Lakshadweep). *Fish. Technol.* 46: 7-14
- Rao, S. V. S. Rajeshwari, G. and Raghuprakash, R. (2002) Studies on the gillnets of Andhra Pradesh, *Fish. Technol.* 39: 15-19
- Sreekrishna, Y. and Shenoy, L. (2001) Fishing Gear and Craft Technology, 242 p, Directorate of Information and Publication of Agriculture. Indian Council of Agricultural Research, New Delhi
- Thomas, S. N. (2001) Gillnets of Kerala: A study on technologies and operational aspects, Ph.D Thesis, 333 p, Cochin University of Science and Technology, Cochin
- Thomas, S. N. and Hridayanathan, C. (2002) Substitution of polyamide multifilament by polyethylene twisted monofilament in large mesh gillnets. *Fish Technol.* 39: 100-106
- Thomas, S. N. and Hridayanathan, C. (2006) Design and general characteristics of marine gillnets of Kerala. *Fish. Technol.* 43: 17-36
- Thomas, S. N., Meenakumari, B., Pravin, P. and George Mathai, P. (2005) Gillnets in Marine Fisheries of India, 45 p, Monograph, ATIC, Central Institute of Fisheries Technology, Cochin
- Thomas S.N. (2010) Gillnet Fishing in India, in Coastal Fishery Resources of India In: Conservation and Sustainable Utilization (Meenakumari, B., Boopendranath, M.R., Edwin, L., Sankar, T.V., Gopal, N. and Ninan, G., Eds), pp 314-326, Society of Fisheries Technologists (India), Cochin

Fuel saving through material substitution in trawls

Remesan M.P., Madhu V.R., Sayana K.A., Prabeesh Kumar, M.V.,
Harikrishnan K.R. and Leela Edwin

ICAR-Central Institute of Fisheries Technology, Cochin

Fishing consumes 15 to 20 times more energy than it produces (Endal, 1980) and the average fuel consumption by the fishing industry is estimated at 15-21.5x10⁶ t (Thomson, 1988). Increased use of fuel intensifies the carbon foot print and green house gas effect which leads to global warming, climate change, etc. Fuel consumption assumes prime importance to fishermen due to hike in

operational costs apart from its environmental effects. According to Tyedemers *et al.* (2005), world fishery fuel consumption is 50 billion (5 x 10⁹) liters. There is an 8% increase in the contribution of fuel cost to the total operating expenses within a time of two years (Fødevareøkonomisk Institut, 2011). Annual fuel consumption of mechanized and motorized fishing

3 ■

FishTech Rep. 3 (1), January-June 2017

sector of India is estimated to be 1220 million liters (Boopendranath, 2000) and about 60-80% of the operational cost is contributed by the cost of fuel consumed.

Trawling is the most energy intensive fishing activity and trawlers are one among the most fuel consuming fishing systems. Compared to passive fishing methods like gillnetting and long lining, trawling consumes five times more fuel and it is 11 times more compared to purse seining. To catch one kilogram of fish, trawling requires 0.8 kg of fuel while for gillnetting 0.15 kg, for long lining 0.25 kg and for purse seining 0.07 kg are required (Gulbrandsen, 1986). The fuel consumption of trawlers which depends on installed engine horse power and duration of voyage constitute 45 to 75% of operational expenditure. The resistance offered by the gear has a large effect upon speed of vessel and fuel consumption.

Even though the fuel price is in an increasing trend, its usage is also increasing due to the increasing size and power of vessels. Fuel consumption is the factor which contributes more than 60% to the total economics of the trawler. Hence reducing the fuel consumption will optimize the economics and carbon footprint of the fishing industry and it is the reason for intensification of research on energy efficiency.

Under the National Agricultural Science Funded (NASF) project on Green Fishing Systems for Tropical Seas (GFSTS), ICAR-CIFT designed and fabricated low drag trawls for fish and shrimp with head rope length 24.47 m and 3.00 m, respectively. The drag reduction measures included in the design are increased mesh size and new material. The material used is ultra high molecular weight polyethylene (UHMWPE). As UHMWPE provides same strength at a lower diameter, the twine size was reduced which results in reduced twine area. For evaluation of new designs, trawl nets using conventional material, high density polyethylene (HDPE) is also fabricated and used as control. The experiments for evaluating the new design were conducted onboard *M.V. Matsyakumari II*. Data regarding drag and fuel consumption experienced for each operation were recorded using Warp tension meter and Fuel flow meter fitted to the



Warp tension meter in use



Operation of UHMWPE trawl nets onboard *M.V. Matsyakumari II*

fuel line of the vessel. The depth of operation ranged from 10 to 20 m, the fishing speed was 3 to 4 kn and the warp length varied from 40 to 100 m.

From the trials conducted, the average reduction in drag of new design is estimated to be 17%. The drag of control and experimental gears at different operational parameters was also analyzed and UHMWPE trawls showed lesser drag than HDPE trawls.

The average fuel consumption per hour of

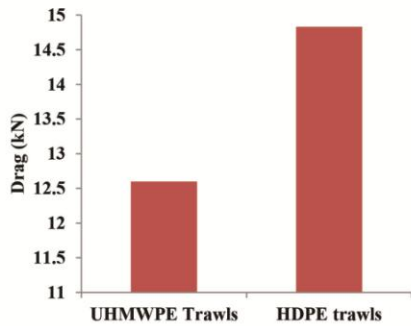

Average drag of HDPE and UHMWPE trawls during one hour of trawling

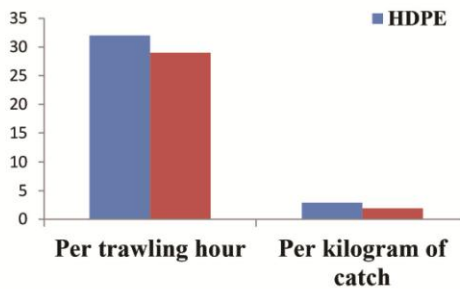

Comparison of fuel consumption of conventional and low drag trawls

trawling for HDPE trawls was estimated to be 30 L and for UHMWPE trawls 26 L. The average reduction in fuel consumption was found to be 10%. The fuel consumption per kg of fish captured

estimated was 2.9 L. for HDPE trawls and 1.9 L. for UHMWPE trawls and the average reduction was 35%.

The drag and the fuel consumption of low drag trawls are 17% and 10%, respectively lower when compared to conventional HDPE trawls. Hence it is evident from the study that, use of energy saving material like UHMWPE will reduce the drag and thereby fuel consumption of trawlers considerably.

References

Boopendranath, M.R. (2000) - Studies on energy requirement and conservation of selected fish harvesting systems. Ph.D. Thesis. Cochin University of Science and Technology, Cochin, India, 273 p.

Endal, A. (1980) - Fuel saving, *Fishing News Intl* **19(10)**: 16-17.

Fødevareøkonomisk Institut (2011): "Fiskeriets Økonomi 2011" Economic Situation of the Danish Fishery, København 2011.

Gulbrandsen, O. (1986) - Reducing Fuel Cost of Small Fishing Boats, BOBP/WP/27, Bay of Bengal Programme, Madras:15 p.

Thomson, D. (1988) - Conflict within the fishing industry, Naga, *ICLARM Quarterly*, July 1988: 3-4.

Tyedmers, P.H., Watson, R., and Pauly, D. (2005) - Fueling global fishing fleets, *Ambio* **34(8)**: 635-638.

CIFT Fishing Systems Catalogue 7

Mechanised Marine Fishing Systems: Karnataka and Goa

Pravin P., Leela Edwin, Remesan M. P., Madhu V. R., Baiju M. V.,
Saly N. Thomas, Aravind S. Kalangutkar, Sayana K. A.



ICAR-Central Institute of Fisheries Technology

CIFT Junction, P.O., Matsyapuri

Kochi – 682 029, India

2016



CIFT Fishing Systems Catalogue 7
Mechanised Marine Fishing Systems:
Karnataka and Goa

©2016 ICAR-Central Institute of Fisheries Technology, Kochi, India

All rights reserved. No part of this publication may be reproduced in any form or by any means, without the prior written permission of the publisher.

ICAR-Central Institute of Fisheries Technology
CIFT Junction, P.O. Matsyapuri, Cochin - 682 029, India
Phone : 91 (0)484-2412300 E-mail : cift@ciftmail.org
Fax : 91 (0)484-2668212 aris.cift@gmail.com

ISBN :

Published by : Dr. C.N. Ravishankar,
Director,
ICAR-Central Institute of Fisheries Technology, Cochin

Citation : Pravin P., Leela Edwin, Remesan M. P., Madhu V. R., Baiju M. V.,
Saly N. Thomas, Aravind S. Kalangutkar, Sayana K. A. (2016) Fishing Systems
catalogue 7 – Mechanised Marine Fishing System: Karnataka and Goa, ICAR-
Central Institute Of Fisheries Technology, Cochin:-P. 76

Printers : PrintExPress, Kaloor, Cochin - 682 018

Cover design : Pradip Kumar Mahato, ICAR-CIFT, Cochin

