STUDIES ON THE ROOT GRAPHS
OF
SOME GRAPH OPERATORS

Thesis submitted to the
Cochin University of Science and Technology
for the award of the degree of
DOCTOR OF PHILOSOPHY
under the Faculty of Science

By

Pravas K.



Department of Mathematics
Cochin University of Science and Technology
Cochin - 682 022

November 2016

TO

MY PARENTS and GRAND PARENTS

Certificate

This is to certify that the thesis entitled '**Studies on the root graphs of some graph operators**' submitted to the Cochin University of Science and Technology by Mr. Pravas K. for the award of the degree of Doctor of Philosophy under the Faculty of Science is a bonafide record of studies carried out by him under my supervision in the Department of Mathematics, Cochin University of Science and Technology. This report has not been submitted previously for considering the award of any degree, fellowship or similar titles elsewhere.

Dr. A. Vijayakumar (Supervisor)

Professor and Head

Department of Mathematics

Cochin University of Science and Technology

Cochin- 682022, Kerala.

Cochin-22

29/11/2016.

Certificate

Certified that all the relevant corrections and modifications suggested by the audience during the Pre-synopsis seminar and recommended by the doctoral committee of the candidate has been incorporated in the thesis entitled “**Studies on the root graphs of some graph operators**”.

Dr. A. Vijayakumar (Supervisor)

Professor and Head

Department of Mathematics

Cochin University of Science and Technology

Cochin- 682022, Kerala.

Cochin-22

29/11/2016.

Declaration

I, Pravas K., hereby declare that this thesis entitled '**Studies on the root graphs of some graph operators**' contains no material which had been accepted for any other Degree, Diploma or similar titles in any University or institution and that to the best of my knowledge and belief, it contains no material previously published by any person except where due references are made in the text of the thesis.

Pravas K.
Research Scholar (Reg. No.3126)
Department of Mathematics
Cochin University of Science and Technology
Cochin-682022, Kerala.

Cochin-22
29/11/2016.

Acknowledgement

I would like to convey my heartfelt gratitude and sincere appreciation to all people who have helped and inspired me during my doctoral study.

First and foremost I express my sincerest gratitude for the unceasing, inspiring and peerless guidance I have received from my supervisor, Prof. A. Vijayakumar, Department of Mathematics, Cochin University of Science and Technology. His perpetual energy and enthusiasm in research extremely motivated me in my studies. Without his valuable suggestions, constructive criticism, and incredible patience this dissertation would not have been possible.

I thank all the former Heads of the Department of Mathematics Prof. A. Krishnamoorthy, Prof. M. Jathavedan, Prof. R.S.Chakravarti and Prof. B. Lakshmy for their support during my research work. I am also grateful to Prof. M. K. Ganapathi, Prof. M. N. N. Namboodiri, Prof. P.G.Romeo, Dr. Ambily A. A. and Dr. Noufal Asharaf for their encouraging words. I also thank the office staff and librarian of the Department of Mathematics for their support and help of various kinds. My gratitude also goes to the authorities of Cochin University of Science and Technology for the facilities they provided. I also thank the University Grants Commission for providing a junior research fellowship for the first three years of my research work.

I also thank the Principal and Staff of Kodungallur Kunhikuttan Thampuram Memorial Govt. College, Pullut, for their support and good wishes. I thank my colleagues Ms. Sreelekha, Dr. Lakshmy, Dr. Resmi, Ms. Sabna, Ms. Sreeja, Ms. Megha, Ms. Ragi, Ms. Muneera and Dr. Merlymole Joseph for the support given to me. I am also thankful to all those who supported me in Sreekerala Varma College, Thrissur, Govt. Polytechnic College, Purappuzha and Govt. Polytechnic College, Koratty, especially Mr. Rajan, Mr. Soman, Mr. Rijoy, Mr. Taji Joseph, Ms. Manchusha, Mr. Anwar and Mr. Omal Babu.

I have always received continuous and generous support from all my fellow researchers. I thank all my Graph Theory friends Dr. B. Radhakr-

ishnan, Dr. Sunitha M.S., Dr. Parvathy K.S., Dr. Indulal G., Dr. Aparna Lakshmanan, Dr. Manju K. Menon, Dr. Seema Varghese, Dr. Chithra M.R., Mr. Shinoj, Ms. Savitha, Ms. Seethu, Ms. Anu and Mr. Tijo for their valuable advices and help. I remember all the fellow researchers Dr. Varghese Jacob, Dr. Sreenivasan C, Dr. Pramod P.K., Dr. Viji M., Dr. Manikandan, Dr. Pamy Sebastian, Dr. Kiran Ku mar, Dr. Dhanya Shajin, Dr. Jaya S., Dr. Lalitha, Dr. Pramod, Dr. Jayaprasad, Dr. Sathian, Mr. Tonny, Ms. Lexy, Ms. Treasa, Mr. A. Rof, Mr. Ajan, Ms. Binitha, Ms. Divya, Mr. Jaison, Mr. Prince, Ms. Savitha, Mr. Shajeeb, Ms. Smisha, Ms. Sreeja, Ms. Susan, Ms. Anusha, Ms. Reshma, Ms. Vinitha, Ms. Akhila, Ms. Smisha, Mr. Manjunath, Mr. Didimos, Mr. Satheesh Kumar and Mr. Yogesh for being always helpful, always jovial, and always patient with me.

My deep most gratitude goes to my parents Valsala Prabhakaran and Kalamandalam Prabhakaran for their unconditional love and blessings throughout my life. Whatever goodness you see in me is merely due to my parents and grand parents. I am thankful to my younger sister Praveena and brother in law Mr. Ratheesh for their care, love and prayers towards me. I am always thankful for all the respect, love and support I have received from my elder brother Praveen and sister in law Pooja Praveen. I wish to mention their daughter Pavithra, who will be happy to see her name when she starts reading.

My wife Divya is always with me, since we met, with continuous encouragement, inspiration, co-operation, suggestions and her patience during my course of study. I fail to find words to express my appreciation and love to her for being with me.

Pravas K.

**STUDIES ON THE ROOT GRAPHS OF
SOME GRAPH OPERATORS**

Contents

List of Figures	ix
List of Tables	xi
1 Introduction	1
1.1 Notations	4
1.2 Definitions	5
1.3 A survey of results and summary of the thesis	9
1.3.1 The median and anti-median operators	9
1.3.2 The line graph operator	13
1.3.3 The anti-Gallai operator	14
2 Median problem on bipartite graphs	17
2.1 Bipartite graphs with prescribed median and anti-median	18
2.2 k -partite graphs with prescribed median and anti-median	20
2.3 Embedding center with median constructions	25
2.4 Embedding center with anti-median constructions	33
2.5 Median problem on symmetric bipartite graphs	36
2.6 Bipartite graph of a graph	41
2.7 The median problem on square of bipartite graphs	45

3	Convex Median and Anti-Median at Prescribed Distance	49
3.1	An upper bound to maximum status difference in a graph	50
3.2	Embedding convex subgraphs at prescribed distance	52
3.3	Construction of the graph H_N	55
3.4	Convex subgraphs with equal status	58
3.5	The value of N	62
4	Root line graphs of some graph classes	71
4.1	Adjacency properties of edges of $L(G)$	72
4.2	Anti-Gallai triangles in $L(G)$	76
4.3	Partitioning the edges of a line graph	83
4.4	An algorithm to find the root graph of a line graph	85
4.5	Root graphs of diameter-maximal line graphs	89
4.6	Root graphs of DHL graphs	91
5	Root graphs of anti-Gallai graphs	99
5.1	Basic definitions	99
5.2	Anti-Gallai triangles in an anti-Gallai graph	100
5.3	Relations between triangles	103
5.4	Identifying the types of triangles in H	119
5.5	Root graphs of anti-Gallai graphs	123
	Concluding Remarks	127
	Bibliography	129
	Index	137
	List of Publications	139

List of Figures

1.1	The status of the vertices in a graph G . Here the vertices u and v induce $M(G)$ and the vertices x, y and z induce $AM(G)$.	6
1.2	An L_5 and a symmetric bi-partite representation of L_5 .	7
1.3	A graph G and $L(G)$.	8
1.4	The $Gal(G)$ and $antiGal(G)$ for the graph G in Figure 1.3.	9
2.1	A graph G with P_4 as the median.	20
2.2	A graph H with P_4 as the anti-median.	21
2.3	Construction in Theorem 2.2.1.	22
2.4	On left: a 3-partite graph G on 5 vertices. On right: a 3-partite graph H with $M(H) \cong G$.	23
2.5	Construction in Theorem 2.2.2. Here the shaded graph in the background is the graph in Figure 2.3.	24
2.6	Construction in Theorem 2.3.1. Here the white-black coloring illustrates the bipartition of the graph. The dotted circles represent a set of vertices and a line between them represent all possible edges between its two ends.	26
2.7	The graphs G and J of Example 2.3.3	28

2.8	The graph H , constructed from G by Theorem 2.2.1, and J' , the k -partite gadget graph of J , of Example 2.3.3	28
2.9	The subgraph labels and vertex labels in the graph W , Example 2.3.3	29
2.10	An outline of construction in Theorem 2.4.1	34
2.11	Distances from a vertex in P , based on Figure 2.10	35
2.12	A construction as in Theorem 2.5.2	39
2.13	A construction as in Theorem 2.5.4	41
2.14	Illustration of Theorem 2.6.6	44
2.15	Illustration of Definition 2.7.4	46
2.16	The graph of G^2 of G in Figure 2.1. We have $M(G^2) \cong (M(G))^2 \cong K_4 - e$	48
3.1	The graph H_0 . Here the solid lines are of length $2D$ and dashed lines are of length D . The solid line paths and the paths of length $r + 1$ induce the subgraph denoted by \boxtimes , given in Step 1(b). Here the numbers $p - 1$ and q are chosen as per Step (3-a) of the construction.	54
3.2	The subgraph \boxtimes , given by step 1(b), and the edges from a_i^* as per step 4 of the construction.	56
3.3	A graph H_N in the construction of $(P_3, P_3, 1)$, in which $ V(H_0) = 100$. Here the black vertices represent complete graphs of size N and solid edges denote all possible edges between the nodes.	59
3.4	The \boxtimes graph for Example 3.5.2. Here the vertex labels are assigned as per the graph H_2 given in Figure 3.5	64
3.5	The vertex labels of graph H_2 of Example 3.5.2	66
3.6	The graph J_5 of Example 3.5.2	68

4.1	Forbidden Subgraphs of line graph.	73
4.2	Two possible labellings of $K_4 - e$ and its line graph $C_4 \vee K_1$	76
4.3	A graph and the hanging of its line graph by vertex f . The dotted lines show an $L\Delta fgh, R\Delta hij$ and an $M\Delta abc$	80
4.4	The graphs for Theorem 4.6.1: house, domino and gem graphs.	92
4.5	A graph $G \in \mathcal{T}_\Delta$	95
4.6	A $\{C_4, K_4, K_4 - e\}$ -free graph G . Clearly $G \in \mathcal{T}_\Delta^c$	98
5.1	A triangle reducible graph G and a triangle irreducible graph H	100
5.2	Graphs $K_4, \text{antigal}(K_4)$ and $\text{antigal}^2(K_4)$	102
5.3	Illustration of Theorem 5.3.5. Here $H \cong \text{antigal}(G)$, $\Delta t = t_1 t_2 t_3$ and $\Delta s = s_a s_b s_c$ are type II and $\Delta t \mathcal{R} \Delta s$	105
5.4	A graph G , $H \cong \text{antiGal}(G)$ and B_H	106
5.5	When an edge y_k coincide with an edge z_j	110
5.6	Proof of Theorem 5.3.8. Case 1 and 2.	111
5.7	A relabelling obtained by interchanging the labels of the thick and dotted edges give the same C_6^* in B_H	113
5.8	On top: a graph $H_{11}^{P^*}$ with one copy of P_{11} is labelled. On bottom: a graph $H_8^{C^*}$. In this the right most C_6^* , with dotted lines, coincide with left most C_6^* , thus making a cycle of C_6^* 's.	115
5.9	A graph G and $H \cong \text{antiGal}(G)$. Here B_H is a graph with 96 vertices containg 16 components of C_6^* 's.	116
5.10	Illustration of Case $B - (II)(1)$ in Theorem 5.3.13.	119

List of Tables

2.1	The labels and status of the vertices of the graph W , Example 2.3.3	30
2.2	The labels and eccentricities of the vertices of the graph W , Example 2.3.3	32
3.1	The difference in the status of the vertices in $V(H_1)$ in the graphs H_1 and H_2	67
3.2	The status of the vertices in J_5	69
4.1	Graph G , for Corollary 4.5.4	91

Chapter 1

Introduction

The mathematical structures known as graphs are used to model pair-wise relations between objects from a certain collection. The study of graphs-Graph Theory-is the branch of mathematics originated in 18th century. Leonhard Paul Euler (1707- 1783)- was the pioneering Swiss mathematician who led the foundation of very vast and important field of graph theory- created the first graph and hence solved the first problem using graph theory-The Königsberg bridge problem- which was considered to be one of the toughest problems during that time.

The study of games and recreational mathematics have always motivated the development of graph theory and by the end of 19-th century, a great deal of progress in this mathematical discipline has made graph theory to be a branch of mathematics

which have applications in many areas-anthropology, architecture, biology, chemistry, computer science, economics, physics, psychology, sociology and telecommunications- to name a few.

Also, graph theory is considered to be the branch of mathematics which is ideally suited for the rigorous analysis of the very large scale interconnection(VLSI) networks[56]. Applications of graphs in this information age also include the study of real world networks such as WWW, social networks etc[7, 13].

The study on ‘Graph operators’ has been of interest, since the pioneering work by O. Ore[36] in his book- The Theory of Graphs- on the well known graph operator, the line graph of a graph. The monograph entitled ‘Graph dynamics’ by E. Prisner[43] and the survey paper[50] by J. L. Szwarcfiter contain most of the progress made by the community working in this area.

The study on Graph operators, operators defined on families of graphs, deals with the notions such as convergence, divergence, fixednes etc. A variety of graph classes can be obtained by choosing suitable graph operators. The line graphs, the Gal-lai graphs, the cycle graphs are some of the examples. On the other hand, the images of the graphs in a graph class under an

operator is also considered as another graph class. The squares of trees, the line graphs of bipartite graphs are some examples in this context. Under such a scenario, the following question is being investigated: Given a graph operator T and a graph G , can the graph G be an image of another graph? We raise more related questions, but, after the following definition.

A graph H is a **root graph** of a graph G under an operator T , if $T(H) \cong G$. Thus the above question can be restated as;
 (1) Does there exist a root graph of the given graph G under an operator T ? Now, in a generalised manner, the following questions are also sensible.

2. Given a family of graphs \mathcal{G} , find the family of all graphs \mathcal{H} such that for each $H \in \mathcal{H}$, $T(H) \in \mathcal{G}$.
3. If the graph G has a property \mathcal{P} , find a root graph of G that has also property \mathcal{P} .
4. Let $\{G_i\}_{i \in I}$ be a collection of graphs and $\{T_i\}_{i \in I}$ be operators, then find a (common) root graph H such that $T_i(H) \cong G_i, \forall i \in I$.
5. Find a subclass \mathbb{G} of a graph class \mathcal{G} such that the root graphs of \mathbb{G} can be found in polynomial time.

This thesis entitled ‘**Studies on the root graphs of some**

graph operators' is a humble effort to answer some of these problems raised in the literature on some graph operators.

We shall now consider some basic notions, useful in the thesis, mainly from [6, 11, 12].

1.1 Notations

When $G = (V, E)$ is a graph,

$V(G)$:	vertex set of G
$E(G)$:	edge set of G
$ V $:	order of G
$ E $:	size of G
$\deg(v)$:	degree of v
$\Delta(G)$:	maximum degree in G
$\delta(G)$:	minimum degree in G
$G \cong H$:	G is isomorphic to H
P_n	:	path of length n
C_n	:	cycle of length n
K_n	:	complete graph on n vertices
$K_n - e$:	an edge removed from K_n
$d_G(u, v)$:	distance between u and v in G
$e(v)$:	eccentricity of v
$r(G) = \min_{v \in G} e(v)$:	radius of G
$d(G) = \max_{v \in G} e(v)$:	diameter of G

1.2 Definitions

Definition 1.2.1. A graph H is called an **induced subgraph** of G if E' is the collection of all edges in G which has both its end vertices in V' . The induced subgraph with vertex set V' is denoted by $\langle V' \rangle$. A maximal complete subgraph is called a **clique**.

Definition 1.2.2. A graph G is **H -free** if it does not contain H as an induced subgraph. Given a nonempty class \mathcal{C} of graphs, a graph G is said to be **\mathcal{C} -free**, if none of the induced subgraphs of G belongs to \mathcal{C} .

Definition 1.2.3. The **join** of two graphs G and H , denoted by $G \vee H$, is the graph obtained from the disjoint union of G and H by adding the edges $\{uv : u \in V(G), v \in V(H)\}$.

Definition 1.2.4. A **BFS tree** from a root vertex of a graph G is a spanning tree of G in which every path from a vertex to the root vertex is a shortest path in G .

Definition 1.2.5. The **center** $C(G)$ of a graph G is the subgraph induced by those vertices of G having minimum eccentricity and the **periphery** $P(G)$ is the subgraph induced by those vertices of G having maximum eccentricity.

Definition 1.2.6. The **status** of a vertex $S(u) = \sum_{v \in V(G)} d_G(u, v)$.

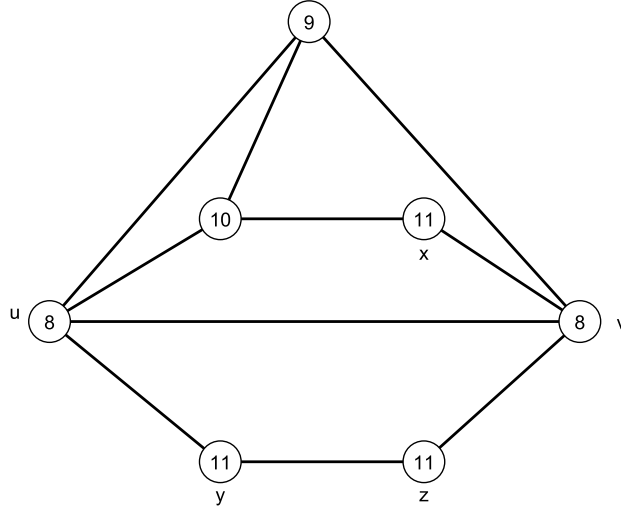

Figure 1.1: The status of the vertices in a graph G . Here the vertices u and v induce $M(G)$ and the vertices x, y and z induce $AM(G)$.

When H is a subgraph of G , $S_G(u, H) = \sum_{v \in V(H)} d_G(u, v)$. The **maximum status difference** in a graph G is $SD(G) = \max_{u, v \in V(G)} |S_G(u) - S_G(v)|$. The subgraph induced by the vertices of minimum (maximum) status in G is known as the **median (anti-median)** of G , denoted by $M(G)$ ($AM(G)$).

Definition 1.2.7. A graph G is **k -partite** if the vertex set can be partitioned into k - non-empty sets X_1, \dots, X_k such that no two vertices in X_i are adjacent for $1 \leq i \leq k$. A k -partite graph in which each vertex in X_i is adjacent to every vertex in X_j , $j \neq i$, is called a **complete k -partite graph**. If $|X_i| = n_i$, then the complete k -partite graph is denoted by K_{n_1, \dots, n_k} . A

2-partite graph is called a **bipartite graph** and its bipartition is denoted by (X_1, X_2) . A complete 2-partite graph is called a complete bipartite graph. The complete bipartite graph $K_{1,n}$ is called a **n -star**. The graph $K_{1,3}$ is called a **claw**.

Definition 1.2.8. A bipartite graph G is a **symmetric bipartite graph** if for a bi-partition (X, Y) of G , there is a map f from X onto Y such that for every edge $(u, f(v))$ in G , there is an edge $(v, f(u))$ in G , where $u, v \in X$. Such a partition is called a **symmetric bipartition** of G denoted by $(X, Y)_f$. The **ladder graph** $L_n = \{x_i, y_i\}_{i=1}^n$ is obtained from two paths x_1, \dots, x_n and y_1, \dots, y_n on n vertices and making x_i and y_i adjacent for each i . It has a bipartition (X_L, Y_L) , where $X_L = \{x_i : i \text{ is odd}\} \cup \{y_i : i \text{ is even}\}$ and $Y_L = V(L_n) \setminus X_L$.

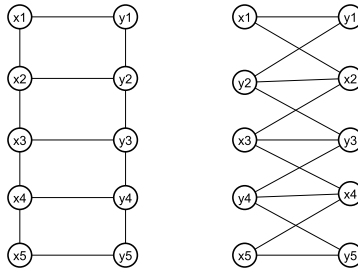

Figure 1.2: An L_5 and a symmetric bi-partite representation of L_5 .

Definition 1.2.9. A graph G is **chordal** if each cycle of length at least four in G has an edge between two non-consecutive vertices in the cycle.

Definition 1.2.10. Let \mathcal{G} be a set of graphs. A **graph operator** T maps a graph in \mathcal{G} to another. The family of graphs $G \in \mathcal{G}$ such that $T(G) = H$ are called the **root graphs** of H under T .

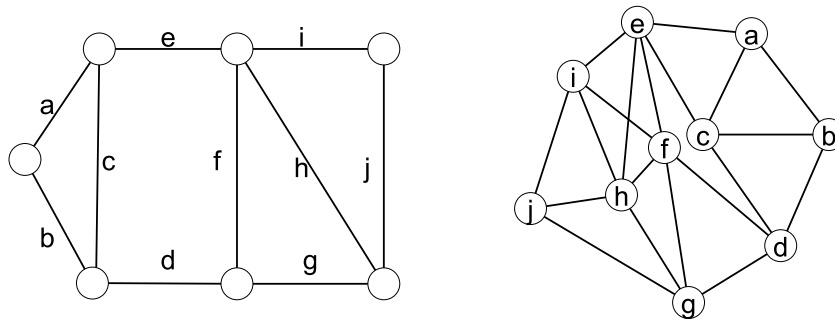

Figure 1.3: A graph G and $L(G)$.

Definition 1.2.11. The **line graph** $L(G)$ of a graph G has as its vertices, the edges of G , and any two vertices are adjacent in $L(G)$ if the corresponding edges are incident in G . A graph G such that $L(G) \cong H$ is called a **root line graph** of H .

Definition 1.2.12. The **Gallai graph** $Gal(G)$ of a graph G has as its vertices, the edges of G , and any two vertices are adjacent in $Gal(G)$ if the corresponding edges are incident in G , but do not span a triangle in G . The **anti-Gallai graph** $antiGal(G)$ of a graph G has as its vertices, the edges of G , and any two vertices of G are adjacent in $antiGal(G)$ if the corresponding edges are incident in G and lie in a triangle in G .

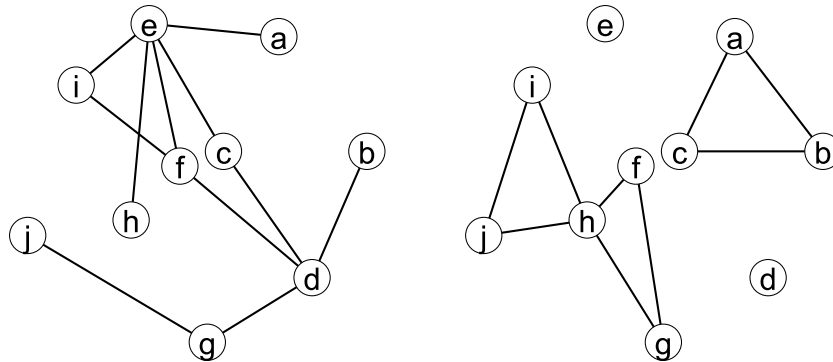

Figure 1.4: The $Gal(G)$ and $antiGal(G)$ for the graph G in Figure 1.3.

1.3 A survey of results and summary of the thesis

In this section we will provide a survey of results on the three operators we studied in this thesis and provide a chapter-wise summary of the thesis. Unless otherwise specified, all graphs are connected and all subgraphs mentioned in this thesis are induced subgraphs.

1.3.1 The median and anti-median operators

The median of a graph is one of the centrality concepts, together with the notions such as center and centroid, is defined using distance, which is one of the widely used concepts in graph

theory[12]. In network theory these concepts are known as ‘facility locations’. The problems of finding facility locations naturally arise in situations like placing post offices, warehouses or emergency services such as hospitals or fire stations. For instance, the median of a graph is a node in a graph or network which minimizes the sum of the distances to other nodes in that graph. In network theory, the problem of finding the median is significant as it is related to the optimization problems involving the placement of network servers, the core of the entire networks, especially in very large interconnection networks.

The studies on the structure of facility locations started with [25], where it is shown that the center and the centroid of a tree consists of one vertex or two adjacent vertices. Study on the centers of different classes of graphs can be seen in [44, 45, 33, 29, 58]. As described in [27, 12] Hedetniemi proved that any graph G is isomorphic to the center of some graph H of diameter 4 and radius 2.

‘Can any graph G be the median of another graph?’ is also a natural problem raised in this context and it was solved by Slater [48]. In [32], the number of vertices used for such a construction was shown to be $\leq 2|V(G)|$, and it was improved to $2|V(G)| - \delta(G) + 1$ in [21]. Followed by Hakimi[20] in 1964, in

which the median location is shown to be the optimum location for minimizing the transportation costs to a facility and center to be the optimum location for an emergency response facility, studies and surveys on locations in graphs are presented in [18, 19, 52]. The book by Buckley and Harary [12] had brought together most of such results in the literature of that time.

When the graph operators under consideration maps a graph into its subgraphs, the problem of finding a common root graph is also referred to as a simultaneous embedding problem. For instance, in [21] it is shown that given two graphs G_1 and G_2 , there exists a graph H with G_1 as the median and G_2 as the center and still be disjoint. In another words, there is a common root graph H such that $M(H) \cong G_1$ and $C(H) \cong G_2$. Later, Hobart [22] extended this result by showing that $d_H(G_1, G_2)$ can be any integer n in such a construction. The problems of finding common roots for different operators such as center, periphery, median, anti-median, centroid, etc., can be seen in [5, 10, 49, 55].

However, the median constructions for general graphs cannot be directly applied to many networks as their underlying graph belong to different classes of graphs. Hence, the study of the median operator for different classes of graphs [46, 57] is also significant. We note that the underlying graphs of many networks

are bipartite. For example, most of the analysis in network communities are done using preference networks [26] and they are modeled using bipartite graphs. In **Chapter 2**, we present a study on the root graphs of k -partite graphs and some related sub-classes under median and anti-median operators. We also provide some general solutions using the techniques developed in this Chapter.

Security has become one of the most important area of concern in networks, which deals with the sharing and transaction of different forms of data. A convex structure in a subnetwork allows a safe data transaction through the shortest paths available between any two nodes in it. Thus the term ‘convexity’ in graphs can equally be used in place of the word ‘security’ in data transactions in networks. Consider the problem of simultaneous embedding of two graphs G_1 and G_2 in graph H such that $M(H) \cong G_1$ and $AM(H) \cong G_2$. Also, consider an additional requirement that any shortest path between the vertices of G_1 (and G_2) is within these facility locations. This will give these locations an advantage of transporting the materials without affecting the outside regions. This requirement can be made by keeping both G_1 and G_2 convex subgraphs of H . A construction with $M(H) = G$ and G is convex in H is in [15]. For a positive integer r , let $H = (G_1, G_2, r)$ denote a graph with

$d_H(G_1, G_2) = r$, $M(H) \cong G_1$, $AM(H) \cong G_2$ and both G_1 and G_2 are convex subgraphs of H . Such a construction is in [5] for graphs which satisfy $r \geq \lfloor d(G_1)/2 \rfloor + \lfloor d(G_2)/2 \rfloor + 2$.

In **Chapter 3**, the problems of embedding median and anti-median subgraphs is explained and we have provided an optimal solution to it by showing that (G_1, G_2, r) exists for every G_1, G_2 and $r \geq 1$.

1.3.2 The line graph operator

The family of **line graphs** $L(G)$ [28] is a class of graphs defined by the operator Line graph of a graph. It is well known that not every graph is a line graph. For, the line graphs admit a forbidden subgraph characterization[9]. The existence of real world networks modeled by line graphs can be seen in [34, 35]. The only root line graphs with isomorphic line graphs are K_3 and $K_{1,3}$ [54]. The algorithms presented in[31, 47] show that the construction of root line graph from a line graph can be done in polynomial time.

In **Chapter 4**, we present an algorithm to partition the edge set of a line graph $L(G)$ to the edge sets of the Gallai and anti-Gallai graphs of G . The properties of the edges in a hanging of a line graph is used to present an optimal algorithm for deter-

mining the root line graph of a given line graph. We also present it as a recognizing algorithm for a given line graph. Finally, the root line graphs of the graph classes such as diameter-maximal, distance-hereditary, Ptolemaic and chordal graphs are also obtained.

1.3.3 The anti-Gallai operator

The class of Gallai graphs and anti-Gallai graphs also defined based on the operators Gallai and anti-Gallai respectively. We justify the importance of the study on this operator simply using [30], in which it is shown that the four color theorem can be equivalently stated in terms of anti-Gallai graphs. In addition, the problems of determining the clique number and the chromatic number of $Gal(G)$ are NP-Complete[30].

We see, from the definitions, that the Gallai and the anti-Gallai graphs are spanning subgraphs of a line graph. In fact, they are complement to each other. However, we can see that there are lots of results on this graph class, that are different from the class of line graphs. As an example, both the Gallai graphs and the anti-Gallai graphs cannot be characterized using forbidden subgraphs. In [3] it is shown that there are infinitely many pairs of non-isomorphic graphs of the same order having isomorphic Gallai graphs and anti-Gallai graphs. In [2] it is

shown that the complexity of recognizing anti-Gallai graphs is NP-complete.

In **Chapter 5**, the root graphs of anti-Gallai graphs are investigated. We find a structural relation between the triangles in an anti-Gallai graph and present an algorithm to find a root graph of anti-Gallai graphs that are triangle irreducible.

In a Gallai graph, a triangle corresponds to a unique $K_{1,3}$ in its root graph and any edge correspond to a unique $K_{1,2}$. Hence finding one root graph of a Gallai graph is not challenging, however, we have kept the problem of finding all root graphs of a given Gallai graph as a further study and therefore not included in this thesis.

Chapter 2

Median problem on bipartite graphs

This chapter deals with the median problem on k -partite graphs and some of its sub classes¹. We prove the existence of k - partite graphs as the root graphs of k -partite graphs, for some k , under the median and anti-median operators. Similar results for some subclasses of k -partite graphs are also presented in this chapter. The commutative properties of the median and anti-median operators with two graph operators, the bipartite graph of a graph and the square of a graph, are also discussed.

¹Some results in this chapter are in the following publications

1. K. Pravas, A. Vijayakumar, The median problem on k -partite graphs, *Discuss. Math. Graph Theory*, 35 (2015), 439-446.
- 2 K. Pravas, A. Vijayakumar, On median problem on symmetric bipartite graphs, *Lecture Notes in Comput. Sci.*(Proceedings of the International Conference on Theoretical Computer Science and Discrete Mathematics, Kalasalingam University, Krishnankoil, 2016). (to appear).

When presenting the results for k -partite graphs, we use different methods for the cases when $k = 2$ and $k \geq 3$.

2.1 Bipartite graphs with prescribed median and anti-median

Lemma 2.1.1. *Given a bipartite graph G of n vertices, there exists a connected bipartite graph H' such that G is an induced subgraph of H' and all the vertices of G in H' have equal status in H' .*

Proof. Let X, Y be a bipartition of $V(G)$ and X', Y' be the copy of X, Y such that v' denote the copy of a vertex $v \in V(G)$. Consider two new vertices v_x and v_y . Make v_y adjacent to all vertices of $X \cup X'$ and v_x adjacent to all vertices of $Y \cup Y'$. Also, for each $v \in X$ (Y) make v' adjacent to $Y \setminus N(v)$ ($X \setminus N(v)$). Now, when $v \in X$, $S_{H'}(v) = 1 \cdot |N(v) \cup Y \setminus N(v) \cup \{v_y\}| + 2 \cdot |X \setminus \{v\} \cup X' \cup \{v_x\}| + 3 \cdot |N(v) \cup Y \setminus N(v)| = 4n + 1$. A similar calculation when $v \in Y$ gives $S_{H'}(v) = 4n + 1$, for all $v \in V(G)$. Also, it follows from the construction that H' is bipartite. \square

Note 2.1.2. The graph H' is called the **bipartite gadget graph** of G . Let $|X| = n_1$ and $|Y| = n_2$. Then we have, in H' , $S(v_x) = 4n + 1 - (2n_1 - 2)$, $S(v_y) = 4n + 1 - (2n_2 - 2)$ and $4n + 1 \leq S(v') \leq 4n + 1 + 2\Delta(G) + 2 + 2\max(n_1, n_2)$, for each

$v \in V(G)$.

Theorem 2.1.3. *Given a bipartite graph G there exists a bipartite graph H such that $M(H) \cong G$.*

Proof. The proof is by construction. Let H' be the bipartite gadget graph of the graph G . Choose a positive integer $s > \max(n_1, n_2) - 1$. Introduce s copies of K_2 and make one end of each K_2 adjacent to all the vertices of X and the other end to all the vertices of Y . Denote this graph by H . Then for each vertex $v \in V(G)$, $S_H(v) = S_{H'}(v) + s + 2s = 4n + 1 + 3s$. Also, for each $v \in V(H' \setminus G)$ the status is increased by $5s$. Let x be an arbitrary vertex from the newly added s copies of K_2 . It is easy to verify that $S_H(x) \geq 4n + 1 + 5s$. Hence $S_H(v) < S_H(u)$, for all $v \in V(G)$, for all $u \in V(H \setminus G)$, hence $M(H) \cong G$. \square

Theorem 2.1.4. *Given a bipartite graph G there exists a bipartite graph H such that $AM(H) \cong G$.*

Proof. The proof is by construction. Let H' be the bipartite gadget graph of the graph G . Consider the complete bipartite graph $K_{s,s}$, where $s > \max(n_1, n_2) + \Delta(G) + 1$. Make the s vertices in one partition of $K_{s,s}$ adjacent to $v_y \cup Y'$ and the other s vertices to $v_x \cup X'$. Denote this graph by H . Then $S_H(v) = 4n + 1 + 5s$ for all the vertices in the subgraph G of H and for each other vertex in the subgraph H' of H , the status is increased by $3s$. Let x be a vertex in $K_{s,s}$ that is in the same

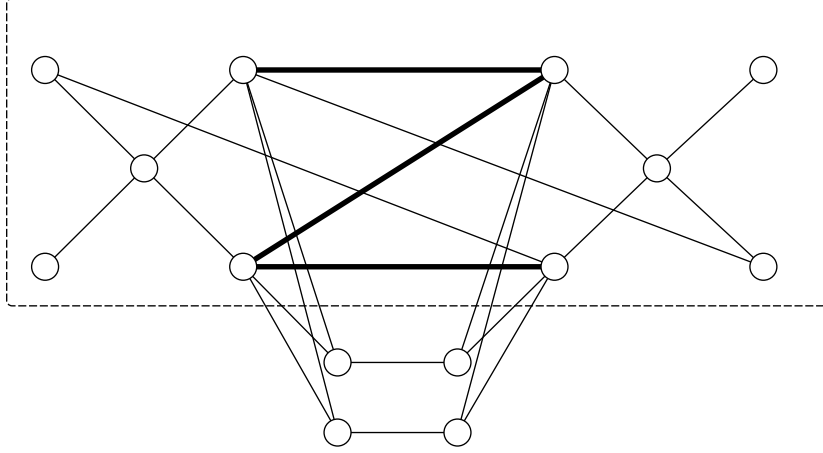

Figure 2.1: A graph G with P_4 as the median. Here, the subgraph in the dotted box is the bipartite gadget graph of P_4 .

partition of X . Then, $S_H(x) = 1 \cdot (|X' \cup \{v_x\}| + s) + 2 \cdot (|Y \cup Y' \cup \{v_y\}| + s - 1) + 3 \cdot |X| = 4n + 1 + 3s$. Similar arguments show that $S_H(x) = 4n + 3s + 1$ for all x in $K_{s,s}$. Hence $S_H(v) > S_H(u)$, for all $v \in V(G)$, for all $u \in V(H \setminus G)$, and $\text{AM}(H) \cong G$. \square

Remark 2.1.5. The number of vertices used in both constructions in Theorems 2.1.3 and 2.1.4 is $2(n + s + 1)$, where the value of s depends on the corresponding construction rules.

2.2 k -partite graphs with prescribed median and anti-median

In the following section we assume that $k \geq 3$.

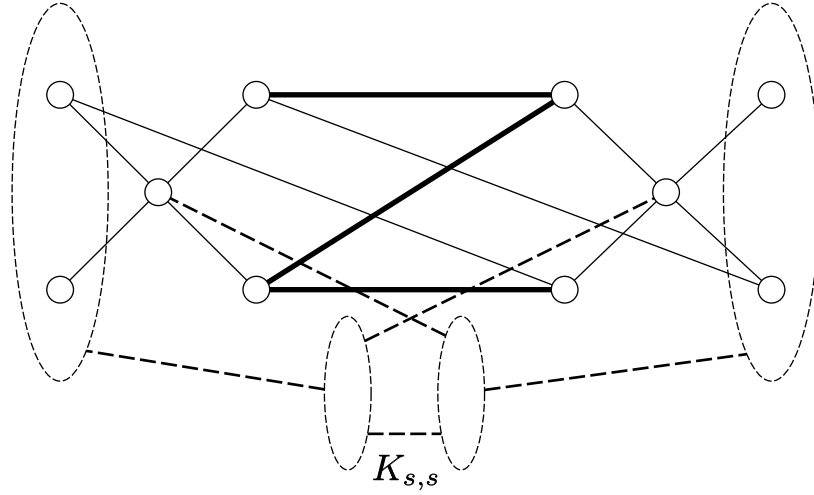

Figure 2.2: A graph H with P_4 as the anti-median. Here the dotted circles represent a set of vertices and the dotted lines represent all possible edges between its two ends.

Theorem 2.2.1. *Given a k -partite graph G there exists a k -partite graph H such that $M(H) \cong G$.*

Proof. The proof is by construction. Consider two functions f and g defined on an index set $I = \{1, 2, \dots, k\}$ as

$$f(i) = \begin{cases} 1, & \text{if } i = k \\ i + 1, & \text{if } i \neq k \end{cases} \quad \text{and} \quad g(i) = \begin{cases} k, & \text{if } i = 1 \\ i - 1, & \text{if } i \neq 1. \end{cases}$$

Let $\{X_i\}_{i \in I}$ be a partition of $V(G)$ with $|X_i| = n_i$. For each vertex $v \in X_i$, introduce three vertices $v_1 \in X_{g(i)}$, $v_2 \in X_{f(i)}$ and $v_3 \in X_i$ such that v_1 and v_2 are adjacent to both v and v_3 . We refer v_1 and v_2 as the ortho vertices of v , and v_3 as the para

vertex of v . Denote this graph as the k -partite gadget graph of G .

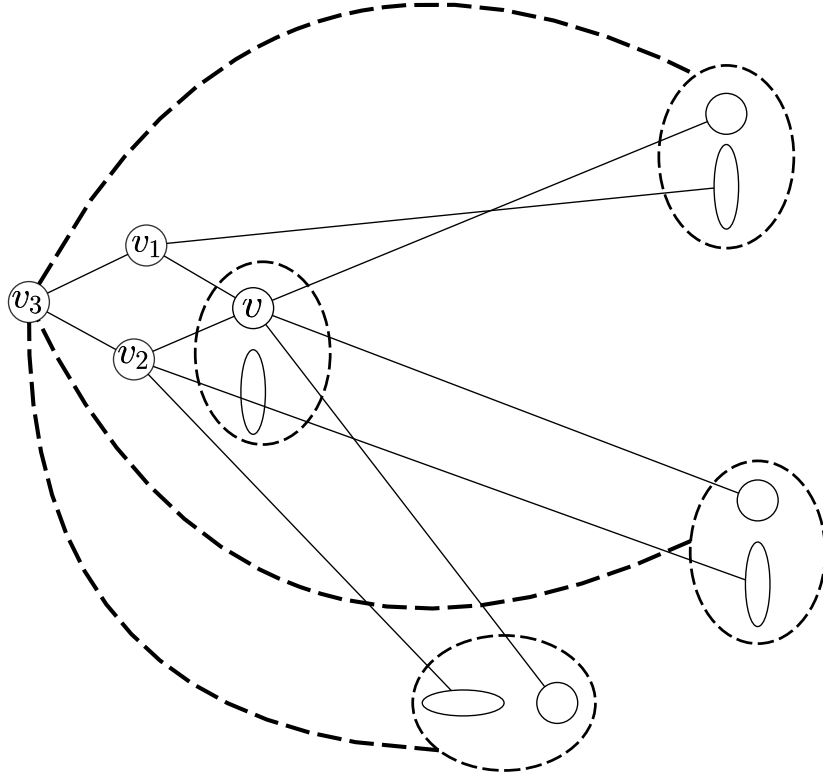

Figure 2.3: Construction in Theorem 2.2.1. Here the dotted circles represent a set of vertices and the dotted lines represent all possible edges between its two ends.

Make v_1 adjacent to $X_i \cup X_{f(i)} \setminus N_{X_{f(i)}}(v)$, v_2 adjacent to $X_i \cup \bigcup_{j=f(i)+1}^{g(i)} X_j \setminus N_{X_j}(v)$ and v_3 adjacent to $\bigcup_{j \neq i} X_j$. Denote this graph by H (See Figure 2.3).

Consider a vertex v in X_1 . Then, $S(v) = 6 \sum_{i=2}^k n_i + 4n_1 + 2(n_1 - 1) = 6n - 2$. Hence $S(v) = 6n - 2$, for all $v \in V(G)$.

For each vertex $v \in V(G)$ we get $7n + d_{X_2}(v) + 2 \sum_3^k n_i \leq S(v_1) \leq 7n + 3d_{X_2}(v) + 3 \sum_3^k n_i$, $7n - 3 + n_2 + d(v) - d_{X_2}(v) \leq S(v_2) \leq 7n - 3 + 3n_2 + 3d(v) - 3d_{X_2}(v)$ and $7n - 2 - \max_i(n_i) \leq S(v_3) \leq 8n - 4 + \min_i(n_i)$. Hence $M(H) \cong G$. \square

The graph H so constructed has $4n$ vertices. An example is given in Figure 2.4.

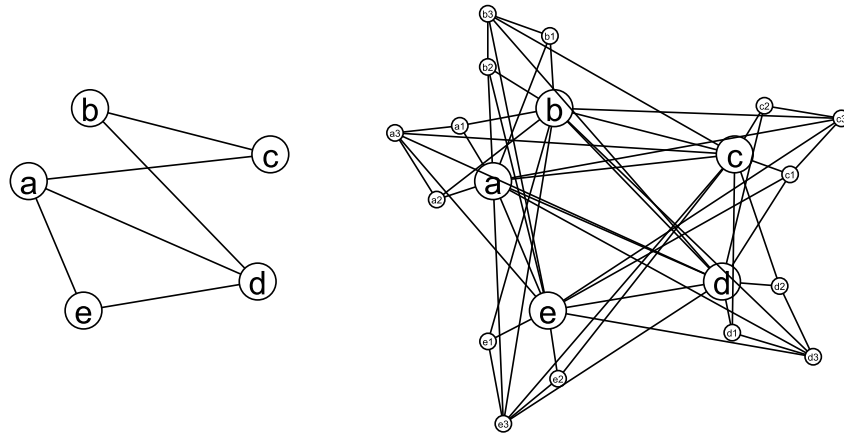

Figure 2.4: On left: a 3-partite graph G on 5 vertices. On right: a 3-partite graph H with $M(H) \cong G$.

Theorem 2.2.2. *Given a k -partite graph G there exists a k -partite graph H' such that $AM(H') \cong G$.*

Proof. The proof is by construction. Let H be the graph obtained using the construction in Theorem 2.2.1. Consider a com-

plete k -partite graph $K_{r,r,\dots,r}$, where $r > \frac{2n+1}{k}$ and let $\{Y_i\}_{i \in I}$ be its k -partition. For each vertex $v \in X_i$ make v_3 adjacent to $\bigcup_{j \neq i} Y_j$, v_1 adjacent to $\bigcup_{j \neq f(i)} Y_j$ and v_2 adjacent to $\bigcup_{j \neq g(i)} Y_j$. In the new graph H' , $S_{H'}(v) = S_H(v) + 2kr$, for all $v \in V(G)$ and $S_{H'}(v_s) = S_H(v_s) + (k+1)r$, for $s = 1, 2, 3$ and hence $\text{AM}(H') \cong G$. \square

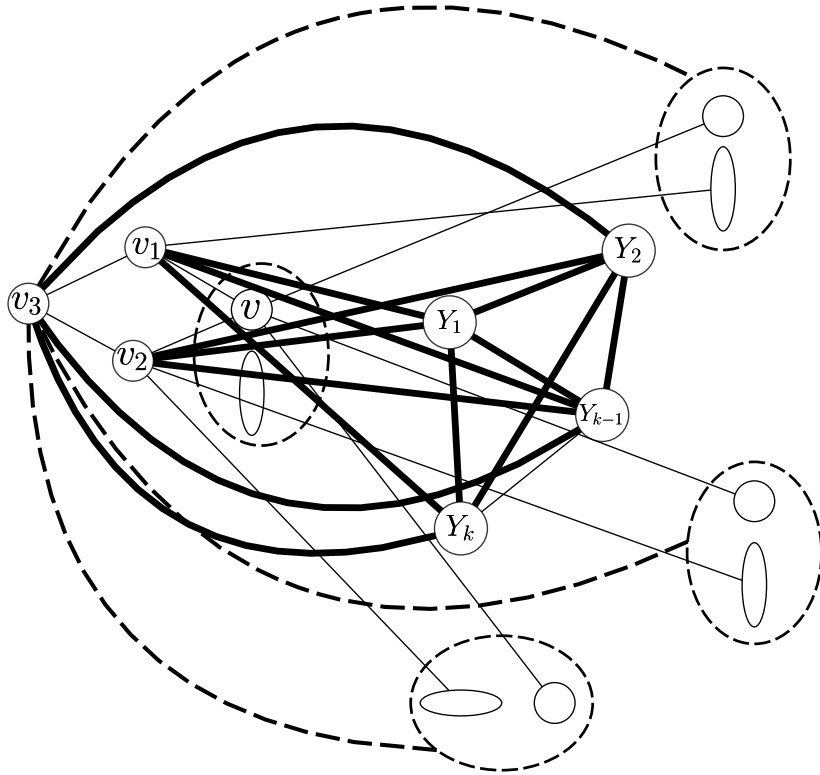

Figure 2.5: Construction in Theorem 2.2.2. Here the shaded graph in the background is the graph in Figure 2.3.

2.3 Embedding center with median constructions

The constructions of a graph with prescribed median naturally faces the following problem. The addition of a vertex in any part of the graph changes the status of each vertex in that graph, thus changing the median preferences in that graph. In this section we embed another k -partite graph as the center of the newly constructed graph keeping the median same in the graphs, which are obtained using previous theorems.

Theorem 2.3.1. *Given two bipartite graphs G and J there exists a bipartite graph H with $M(H) \cong G$ and $C(H) \cong J$.*

Proof. The proof is by construction. Let H' be the bipartite gadget graph of G . For $k \geq 3$ introduce two paths x_1, x_2, \dots, x_{k-1} and y_1, y_2, \dots, y_{k-1} of length $k - 2$. Also, let u_1, u_2, \dots, u_{k+1} and v_1, v_2, \dots, v_{k+1} be two paths of length k . Let R and S be the bi-partition of J such that $|R| \leq |S|$. Make x_1 adjacent to $X \cup \{v_x, y_1\}$, y_1 to $Y \cup \{v_y\}$, x_{k-1} to $R \cup \{y_{k-1}\}$, y_{k-1} to S , u_1 to $R \cup \{v_1\}$, v_1 to S and u_{k+1} to v_{k+1} . Attach $|S| - |R| + 1$ vertices to x_1 and a vertex w to y_1 . Denote this graph by H_0 . Introduce s copies of K_2 , where $s > \text{SD}(H_0)/2$, and make them adjacent to X and Y of G , as in Theorem 2.1.3. Denote this new graph by H . Clearly $C(H) \cong J$ with $e(v) = k + 2$, for all $v \in V(J)$.

$S(x) = S(y) = 4(n+k^2) + k(|R| + |S| + 6) + 3|S| - 2|R| + 3s + 8$,
 for all $x \in X, y \in Y$. For a vertex $v \in V(H)$, let $S^*(u) = d(u, v') + d(u, v'')$, where v' and v'' are the end vertices of a K_2 among the s copies of K_2 in H . $S^*(u) = 3$, when $u \in V(G)$ and $S^*(u) \geq 5$, when $u \in V(H \setminus G) \setminus \{v', v''\}$. Hence $M(H) = G$, when $s > SD(H_0)/2$. \square

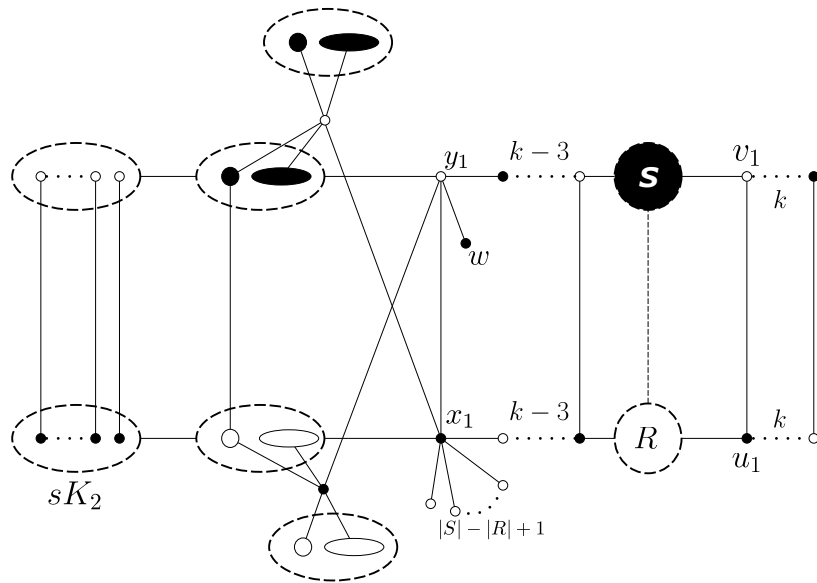

Figure 2.6: Construction in Theorem 2.3.1. Here the white-black coloring illustrates the bipartition of the graph. The dotted circles represent a set of vertices and a line between them represent all possible edges between its two ends.

Theorem 2.3.2. For $k \geq 3$, given two k -partite graphs G and J there exists a k -partite graph W such that $M(W) \cong G$ and $C(W) \cong J$.

Proof. The proof is by construction. Let H be the graph obtained from graph G as in Theorem 2.2.1. Introduce k paths P_{x_i, y_i} of length $r - 2$ with end vertices x_i and y_i , where $i \in I$. A vertex in P_{x_i, y_i} , at a distance t from x_i is denoted by $P_{x_i, y_i}[t]$. For each $t = 0, \dots, r - 3$, make the vertices $P_{x_i, y_i}[t]$, for all i , adjacent so that they induce a complete graph. Similarly introduce k paths $R_{x'_i, y'_i}$ of length r with end vertices x'_i and y'_i and make adjacencies $R_{x'_i, y'_i}[t]$ for each t and every i .

Let $\{Y_i\}_{i \in I}$ be the k -partition of the graph J and let J' be the k -partite gadget graph of J . Let $P(Y_i)$ and $O(Y_i)$ be respectively the sets of para vertices and ortho vertices of Y_i . For each $i, j \in I$ make x_i adjacent to X_i , y_i adjacent to $O(Y_i) \cup_{j \neq i} Y_j \cup_{j \neq i} P(Y_j)$ and x'_i adjacent to Y_i . Denote this graph by W_0 . Introduce s copies of K_k , where $s > \text{SD}(W_0)/2$, and let $\{Y'_i\}_{i \in I}$ denote their k -partition. For each $i \in I$, make all the vertices of Y'_i adjacent to X_i . Denote this graph by W . It can be verified that $C(W) \cong J$, with $e(v) = r + 1$, for all $v \in V(J)$. Also, for all $v \in V(G)$,

$$S_W(v) = 6n + |J|(4r - 2) + k(2r^2 - r - 1) + s(2k - 1). \quad (2.3.2.1)$$

Let $S^*(u) = \sum_{v \in K} d(u, v)$, where K is one of the s copies of K_k . We can see that $S^*(u) = 2k - 1$ when $u \in V(G)$ and $S^*(u) \geq 2k + 1$ when $u \in V(W \setminus G \setminus K)$. Hence $M(W) \cong G$. \square

Example 2.3.3. An Illustration to Theorem 2.3.2

Let G and J be two 4-partite graphs as given in Figure 2.7.

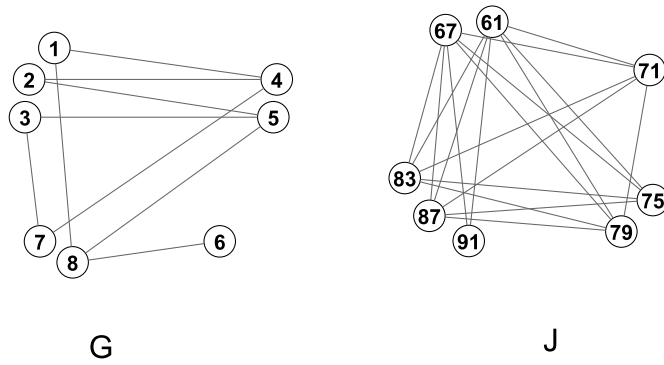

Figure 2.7: The graphs G and J of Example 2.3.3

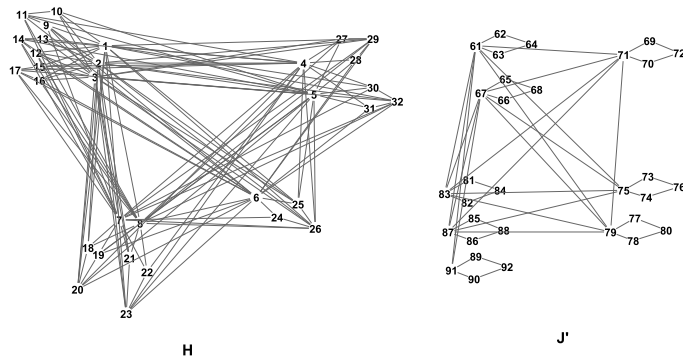

Figure 2.8: The graph H , constructed from G by Theorem 2.2.1, and J' , the k -partite gadget graph of J , of Example 2.3.3

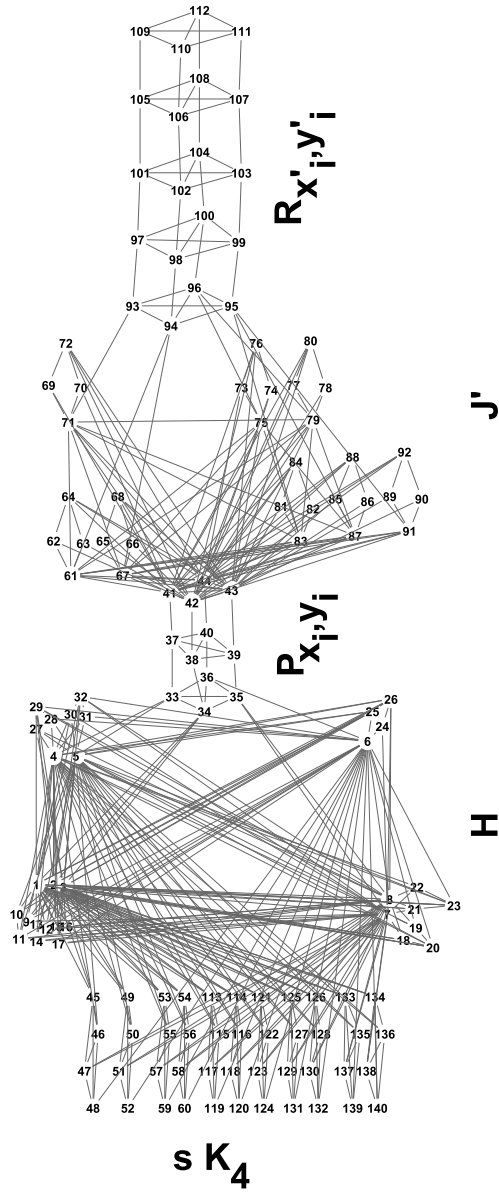

Figure 2.9: The subgraph labels and vertex labels in the graph W , Example 2.3.3

1	2	3	4	5	6	7	8	9	10
445	445	445	445	445	445	445	445	516	541
11	12	13	14	15	16	17	18	19	20
518	515	572	517	541	516	518	537	521	518
21	22	23	24	25	26	27	28	29	30
537	540	518	541	519	515	520	543	514	519
31	32	33	34	35	36	37	38	39	40
543	514	450	448	449	451	470	468	469	471
41	42	43	44	45	46	47	48	49	50
498	496	497	499	568	570	569	571	568	570
51	52	53	54	55	56	57	58	59	60
569	571	568	568	570	570	569	569	571	571
61	62	63	64	65	66	67	68	69	70
545	620	620	576	620	620	545	576	622	622
71	72	73	74	75	76	77	78	79	80
542	572	623	623	544	573	623	623	543	573
81	82	83	84	85	86	87	88	89	90
621	621	546	576	621	621	546	576	621	621
91	92	93	94	95	96	97	98	99	100
549	576	640	639	634	636	748	747	742	744
101	102	103	104	105	106	107	108	109	110
864	863	858	860	988	987	982	984	1120	1119
111	112	113	114	115	116	117	118	119	120
1114	1116	568	568	570	570	569	569	571	571
121	122	123	124	125	126	127	128	129	130
568	570	569	571	568	568	570	570	569	569
131	132	133	134	135	136	137	138	139	140
571	571	568	568	570	570	569	569	571	571

Table 2.1: The labels and status of the vertices of the graph W , Example 2.3.3

Figure 2.9 gives the graph W so constructed. Here we have chosen $k = 4, n = 8, |J| = 4, s = 11$ and $r = 5$. From Figure 2.9, $V(G) = \{1, 2, 3, 4, 5, 6\}$, $V(J) = \{61, 67, 71, 75, 79, 83, 87, 91\}$ and the other vertex labels of the graph W can be identified.

The status of the vertices are given in the Table 2.1, which shows that $M(W) = G$ (see Equation 2.3.2.1), with $S(v) = 445 < S(u), \forall v \in V(G), u \in V(W \setminus G)$.

The eccentricities of the vertices of W is given in Table 2.2, which shows that $C(W) = J$, with $e(v) = 6, v \in V(J)$.

1	2	3	4	5	6	7	8	9	10
10	10	10	10	10	10	10	10	10	10
11	12	13	14	15	16	17	18	19	20
10	10	11	10	10	10	10	10	10	10
21	22	23	24	25	26	27	28	29	30
10	10	10	10	10	10	10	10	10	10
31	32	33	34	35	36	37	38	39	40
10	10	9	9	9	9	8	8	8	8
41	42	43	44	45	46	47	48	49	50
7	7	7	7	11	11	11	11	11	11
51	52	53	54	55	56	57	58	59	60
11	11	11	11	11	11	11	11	11	11
61	62	63	64	65	66	67	68	69	70
6	7	7	7	7	7	6	7	7	7
71	72	73	74	75	76	77	78	79	80
6	7	7	7	6	7	7	7	6	7
81	82	83	84	85	86	87	88	89	90
7	7	6	7	7	7	6	7	7	7
91	92	93	94	95	96	97	98	99	100
6	7	7	7	7	7	8	8	8	8
101	102	103	104	105	106	107	108	109	110
9	9	9	9	10	10	10	10	11	11
111	112	113	114	115	116	117	118	119	120
11	11	11	11	11	11	11	11	11	11
121	122	123	124	125	126	127	128	129	130
11	11	11	11	11	11	11	11	11	11
131	132	133	134	135	136	137	138	139	140
11	11	11	11	11	11	11	11	11	11

Table 2.2: The labels and eccentricities of the vertices of the graph W , Example 2.3.3

2.4 Embedding center with anti-median constructions

In this section we show how to embed a new graph as the center in the anti-median constructions of k -partite graphs. We provide separate constructions for $k = 2$ and $k \geq 3$ cases.

Theorem 2.4.1. *Given two bipartite graphs G and J there exists a bipartite graph W with $AM(W) \cong G$ and $C(W) \cong J$.*

Proof. Let H be the graph constructed in Theorem 2.1.4 with a bi-partition (P, Q) . Let (C, D) be the bi-partition of $K_{s,s}$ in H , where $C \subset P$ and $D \subset Q$. Let (R, S) be the bi-partition of J with $|R| \leq |S|$.

For an integer $k \geq 3$, introduce two ladder graphs $\{x_i, y_i\}_{i=1}^k$ and $\{u_i, v_i\}_{i=1}^{k+1}$. Make x_1 adjacent to P , y_1 to Q , x_2 to D and y_2 to C , x_k to R , y_k to S , u_1 to R , v_1 to S . Attach $|S| - |R| + 1$ vertices to x_2 and a vertex w to y_2 . Denote this graph by H_0 .

Introduce a complete bipartite graph $K_{t,t}$ with a bi-partition (E, F) . Make each vertex in E adjacent to $R \cup \{u_2\}$ and each vertex in F adjacent to $S \cup \{v_2\}$. Call this graph W . See Figure 2.10 for an outline of the construction. Clearly $C(W) \cong J$ with $e(v) = k + 2$, for all $v \in V(J)$ and $S(x) = 4n + 5s + (k + 1)(4k + R + S + 6) + t(2k + 5) + 4S - 3R + 7$, $\forall x \in V(G)$. Calculations can be easily verified from Figure 2.11, which provide the distances of a vertex in P to all other vertices

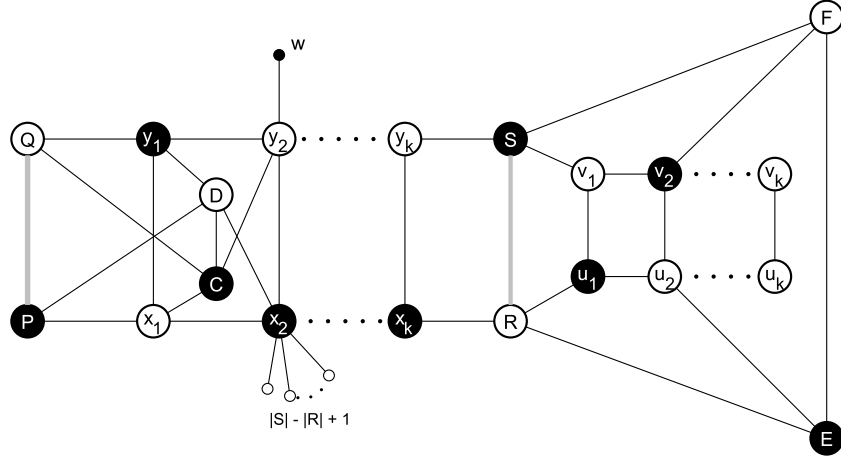

Figure 2.10: An outline of construction in Theorem 2.4.1

in H .

For a vertex $u \in V(W)$, let $S^*(u) = d(u, e) + d(u, f)$, where ef is an edge in $K_{t,t}$. Then, $S^*(u) = 2k + 5$, $u \in V(H)$ and $S^*(u) \leq 2k + 5$, $u \in V(W \setminus H) \setminus \{e, f\}$. Since ef is an arbitrary edge in $K_{s,s}$ and by Lemma 2.1.4, $S_W(x) < S_W(y)$, for every $x \in V(G), y \in V(W \setminus G)$, for $r > SD(H_0)/2$, it follows that $AM(W) = G$. \square

Theorem 2.4.2. For $k \geq 3$, given two k -partite graphs G and J there exists a k -partite graph W such that $AM(W) \cong G$ and $C(W) \cong J$.

Proof. We start the proof with the graph H' in Theorem 2.2.2. Note that $\{Y_i\}_{i \in I}$ is used to denote the partition of the complete

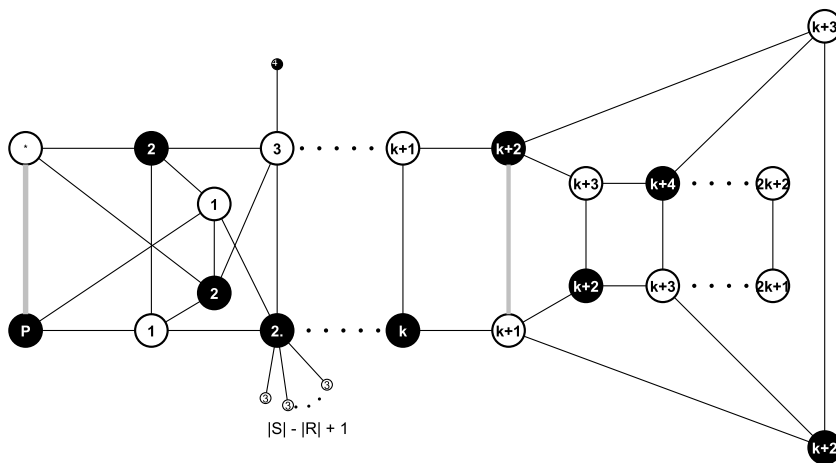

Figure 2.11: Distances from a vertex in P , based on Figure 2.10

k -partite graph $K_{r,r,\dots,r}$ in H' .

Introduce k paths P_{x_i,y_i} of length $d - 3$ with end vertices x_i and y_i , where $i \in I$. A vertex in P_{x_i,y_i} , at a distance t from x_i is denoted by $P_{x_i,y_i}[t]$. For each $t = 0, \dots, d - 3$, make the vertices $P_{x_i,y_i}[t]$, for all i , adjacent so that they induce a complete graph. Similarly introduce k paths $R_{x'_i,y'_i}$ of length $d - 1$ with end vertices x'_i and y'_i and make adjacencies $R_{x'_i,y'_i}[t]$ for each t and every i .

Let $\{Z_i\}_{i \in I}$ be the k -partition of the graph J and let J' be the k -partite gadget graph of J . Let $P(Z_i)$ and $O(Z_i)$ be respectively the sets of para vertices and ortho vertices of Z_i . For each $i, j \in I$ make x_i adjacent to Y_i , y_i adjacent to $O(Z_i) \cup_{j \neq i} Z_j \cup_{j \neq i} P(Z_j)$

and x'_i adjacent to Z_i . Denote this graph by W_0 .

Introduce s copies of K_k , where $s > \text{SD}(W_0)/2$, and let $\{Y'_i\}_{i \in I}$ denote their k -partition. For each $i \in I$, make all the vertices of Y'_i adjacent to $O(Z_i) \cup_{j \neq i} Z_j \cup_{j \neq i} P(Z_j)$. Denote this graph by W . It can be verified that $C(W) \cong J$, with $e(v) = r + 1$, for all $v \in V(J)$ and $S_H(v) = 6n - 2 + 2kr + k|J|(d + 1) + k(2d^2 + 2d - 3) + sk(d + 2)$, for all $v \in V(G)$.

Let $S^*(u) = \sum_{v \in K} d(u, v)$, where K is one of the s copies of K_k . We can see that $S^*(u) = k(d + 2)$ when $u \in V(G)$ and $S^*(u) < k(d + 2)$ when $u \in V(W \setminus G \setminus K)$. Hence $\text{AM}(W) \cong G$.

□

2.5 Median problem on symmetric bipartite graphs

Lemma 2.5.1. *Given a symmetric bipartite graph G , there exists a connected symmetric bipartite graph G' such that G is an induced subgraph of G' and all the vertices of G in G' have equal status in G' .*

Proof. Let $(X, Y)_f$ be a symmetric bi-partition of G . Let X', Y' be the copy of X, Y such that v' denote the copy of a vertex $v \in V(G)$. Consider two new vertices v_x and v_y . Let $A =$

$X \cup X' \cup \{v_x\}$ and $B = Y \cup Y' \cup \{v_y\}$. Define a map g from A to B such that $g(v) = f(v)$, $g(v') = f(v')$, $\forall v \in X$ and $g(v_x) = v_y$.

Then, make v_y adjacent to all the vertices in A and v_x adjacent to all vertices of B . Also, for each $v \in X$ (Y) make v' adjacent to $Y \setminus N(v) \cup \{g(v)\}$ ($X \setminus N(v) \cup \{g^{-1}(v)\}$). Call this graph G' . It now follows that $(A, B)_g$ is a symmetric bi-partition of G' and $S_{G'}(v) = 4n + 1$, for all $v \in V(G)$. \square

The graph G' is called the **symmetric bipartite gadget graph** of G .

Theorem 2.5.2. *Given two symmetric bipartite graphs G and J there exists a symmetric bipartite graph H with $M(H) \cong G$ and $C(H) \cong J$.*

Proof. The proof is by construction. Let G' be the symmetric bipartite gadget graph of G with symmetric bi-partition $(A, B)_f$ and $(R, S)_g$ be a symmetric bi-partition of J . For $k \geq 3$, introduce two ladder graphs $\{x_i, y_i\}_{i=1}^{k-1}$ and $\{u_i, v_i\}_{i=1}^{k+1}$ with symmetric bi-partitions $(X_1, Y_1)_{f_1}$ and $(X_2, Y_2)_{f_2}$ respectively.

Make x_1 adjacent to $X \cup \{v_x\}$, y_1 to $Y \cup \{v_y\}$, x_{k-1} to R , y_{k-1} to S , u_1 to R and v_1 to S . Denote this graph by H_0 . Introduce s copies of K_2 and let $a_i b_i$, $i = 1, \dots, s$ be the edges in sK_2 . Make $\{a_i\}_{i=1}^s$ adjacent to all the vertices in X and $\{b_i\}_1^s$ adjacent to to all the vertices in Y . Denote this new graph by

H . Clearly $C(H) \cong J$ with $e(v) = k + 2$, for all $v \in V(J)$ and $S(x) = S(y) = 4n + 1 + (2k + 1)(2k + 2 + |R|) + 3s$, for all $x \in X$, $y \in Y$.

For a vertex $u \in V(H)$, let $S^*(u) = d(u, a_m) + d(u, b_m)$, where $a_m b_m$ be an edge in the s copies of K_2 in H . Then, $S^*(u) = 3$, $u \in V(G)$ and $S^*(u) \geq 5$, $u \in V(H \setminus G) \setminus \{a_m, b_m\}$. Hence $M(H) = G$, when $s > \text{SD}(H_0)/2$.

When k is even, let $A' = A \cup X_1 \cup X_2 \cup R \cup \{b_i\}$ and $B' = H \setminus A'$. Let h be the function defined on A' by $h(x) = f(x)$, when $x \in A$, $h(x) = g(x)$, when $x \in R$, $h(x) = f_i(x)$, when $x \in X_i$, $i = 1, 2$, and $h(b_i) = a_i$, $1 \leq i \leq s$. It is clear that $(A', B')_h$ is a symmetric bi-partition of H . When k is odd, the elements in R and S are interchanged in the bi-partition (A', B') . Redefining $h(x) = g^{-1}(x)$, for the vertices $x \in S$, $(A', B')_h$ becomes a symmetric bi-partition of H . \square

Lemma 2.5.3. *Given a symmetric bi-partite graph G , there exists a symmetric bipartite graph H such that $AM(H) = G$.*

Proof. Let G' be the symmetric bipartite gadget graph of G and let $(A, B)_f$ be a symmetric bi-partition of G' . Introduce a complete bipartite graph $K_{r,r}$ with symmetric bi-partition $(C, D)_g$. Make each vertex in C adjacent to $Y' \cup \{v_y\}$ and each vertex in

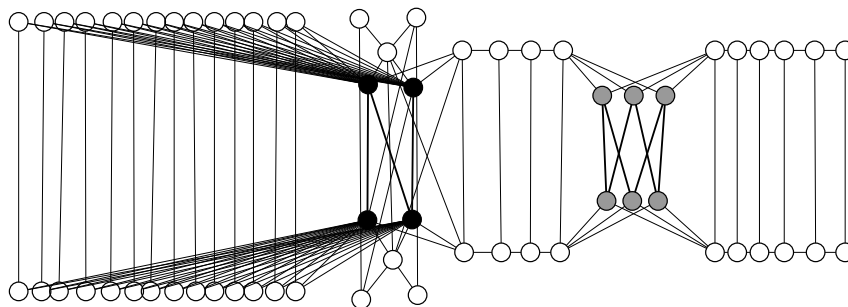

Figure 2.12: A construction as in Theorem 2.5.2

D adjacent to $X' \cup \{v_x\}$. Call this graph H . We can see that $S_H(u) = S_{G'}(u) + 5r$, when $u \in V(G)$ and $S_H(u) = S_{G'}(u) + 3r$, when $u \in V(H \setminus G)$. Choosing $r > SD(G')/2$, we get $AM(H) = G$.

Let $P = A \cup C$ and $Q = H \setminus P$. Define h on P by $h(x) = g(x)$, when $x \in A$, and $h(x) = g(x)$, when $x \in C$. Then, $(P, Q)_h$ is a symmetric bi-partition of H . \square

Theorem 2.5.4. *Given two symmetric bipartite graphs G and J there exists a symmetric bipartite graph H with $AM(H) \cong G$ and $C(H) \cong J$.*

Proof. The proof is by construction. Let H be the graph constructed in Lemma 2.5.3 with symmetric bi-partition $(P, Q)_h$ and let $(R, S)_g$ be a symmetric bi-partition of J . For $k \geq 3$, introduce two ladder graphs $\{x_i, y_i\}_{i=1}^{k-1}$ and $\{u_i, v_i\}_{i=1}^{k+1}$ with symmetric bi-partitions $(X_1, Y_1)_{f_1}$ and $(X_2, Y_2)_{f_2}$ respectively.

Make x_1 adjacent to P , y_1 to Q , x_2 to D and y_2 to C , x_{k-1} to R , y_{k-1} to S , u_1 to R , v_1 to S . Denote this graph by H_0 .

Introduce a complete bipartite graph $K_{s,s}$ with symmetric bipartition $(E, F)_f$. Make each vertex in E adjacent to $R \cup \{u_2\}$ and each vertex in F adjacent to $S \cup \{v_2\}$. Call this graph H . Clearly $C(H) \cong J$ with $e(v) = k + 2$, for all $v \in V(J)$ and $S(x) = S(y) = 4n + 5r + (2k + 1)(2k + R + s) + 2s$.

For a vertex $u \in V(H)$, let $S^*(u) = d(u, e) + d(u, f)$, where ef is an edge in $K_{s,s}$. Then, $S^*(u) = 13$, $u \in V(G')$ and $S^*(u) \leq 11$, $u \in V(H \setminus G') \setminus \{e, f\}$. Since ef is an arbitrary edge in $K_{s,s}$ and by Lemma 2.5.3, $S_{G'}(x) < S_{G'}(y)$, for every $x \in V(G)$, $y \in V(G' \setminus G)$, for $r > SD(H_0)/2$, it follows that $AM(H) = G$.

When k is even, let $A' = P \cup X_1 \cup X_2 \cup R \cup E$ and $B' = H \setminus A'$. Let t be the function defined on A' by $t(x) = h(x)$, when $x \in P$, $t(x) = g(x)$, when $x \in R$, $t(x) = f_i(x)$, when $x \in X_i$, $i = 1, 2$, and $t(x) = f(x)$, when $x \in E$. It is clear that $(A', B')_h$ is a symmetric bi-partition of H . When k is odd, the elements in R and S are interchanged in the bi-partition (A', B') . Redefining $h(x) = g^{-1}(x)$, for the vertices $x \in S$, $(A', B')_h$ becomes a symmetric bi-partition of H . \square

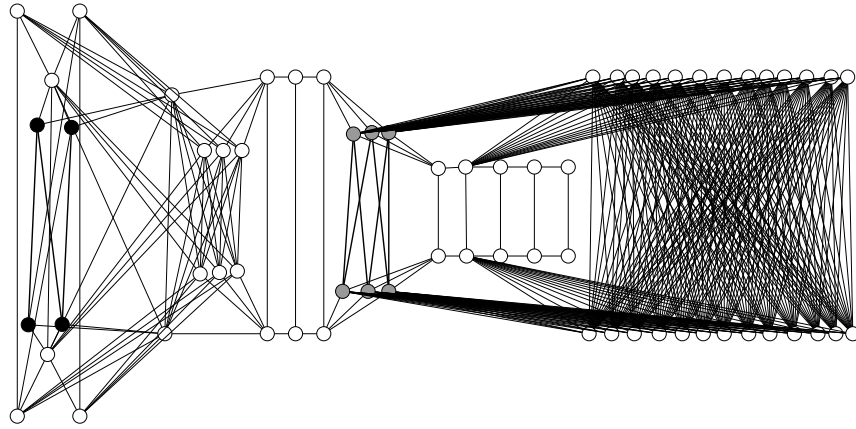

Figure 2.13: A construction as in Theorem 2.5.4

2.6 Bipartite graph of a graph

The bipartite graph $B(G)$ of a graph G can be constructed as follows[6]. For each vertex $v \in V$, form $v' \in X$ and $v'' \in Y$ and let $N(v') = \{u'' \in Y : u \in N[v]\}$ and $N(v'') = \{u' \in X : u \in N[v]\}$. Clearly $B(G)$ is a symmetric bipartite graph. It is not difficult to find a sufficient condition. Hence we state it as a lemma without a proof.

Lemma 2.6.1. *Let G be a connected symmetric bipartite graph. Then $G \cong B(H)$ for some graph H if and only if there is a symmetric bi-partition $(X, Y)_f$ of G such that $uf(u)$ is an edge for all $u \in X$.*

Remark 2.6.2. Consider the graphs G and $B(G)$. Let $u, v \in V(G)$. If $d(u, v)$ is odd, then $d(u', v'') = d(u'', v') = d(u, v)$ and

$d(u', v') = d(u'', v'') = d(u, v) + 1$. Also, if $d(u, v)$ is even, then $d(u', v'') = d(u'', v') = d(u, v) + 1$ and $d(u', v') = d(u'', v'') = d(u, v)$.

In the following theorem, we prove that, for a connected graph, the operator $B(\cdot)$ commute with both $M(\cdot)$ and $AM(\cdot)$.

Theorem 2.6.3. *For any connected graph G , $B(\cdot)$ commute with both $M(\cdot)$ and $AM(\cdot)$. That is, $B(M(G)) \cong M(B(G))$ and $B(AM(G)) \cong AM(B(G))$.*

Proof. Let $H = B(G)$. For a vertex $v \in V(G)$, let O_v and E_v be the set of vertices respectively at odd distance and even distance from v . Then, by Remark 2.6.2,

$$\begin{aligned} \sum_{u \in O_v} d_H(v', u'') &= \sum_{u \in O_v} d_G(v, u) \\ \sum_{u \in O_v} d_H(v', u') &= \sum_{u \in O_v} d_G(v, u) + |O_v| \\ \sum_{u \in E_v} d_H(v', u') &= \sum_{u \in E_v} d_G(v, u) \\ \sum_{u \in E_v} d_H(v', u'') &= \sum_{u \in E_v} d_G(v, u) + |E_v|. \end{aligned}$$

Thus $S_H(v') = 2S_G(v) + n$ and, similarly, $S_H(v'') = 2S_G(v) + n$.

Now, for each vertex v of a graph G , the status of the vertices v' and v'' in $B(G)$ depends only on $S_G(v)$ so that the analogous median properties are preserved. Hence $M(B(G)) \cong B(M(G))$

and $AM(B(G)) \cong B(AM(G))$. \square

Corollary 2.6.4. *For any connected graph G , $B(\cdot)$ commute with $C(\cdot)$.*

Proof. Since $e(u) = \max_v d(u, v)$, the result follows from the definition of the center of a graph. \square

Corollary 2.6.5. *Let $G' \cong B(G)$ and $J' \cong B(J)$ be two connected graphs. Then the following results hold.*

1. *There exist graphs H_1 and H'_1 such that $M(H'_1) = G'$ and $C(H'_1) = J'$ and $H'_1 \cong B(H_1)$.*
2. *There exist graphs H_2 and H'_2 such that $AM(H'_2) = G'$ and $C(H'_2) = J'$ and $H'_2 \cong B(H_2)$.*

Proof. From Theorems 2.5.2 and 2.5.4, we can see that all the symmetric bipartite graphs introduced in these constructions satisfy the conditions of Lemma 2.6.1. Hence, starting with symmetric bipartite graphs G' and J' which are also bipartite graphs of some graphs, we obtain H'_1 and H'_2 satisfying the required conditions in the assertion. \square

We now show that a general solution of median and anti-median problems can be obtained from the results on symmetric bi-partite graphs.

Theorem 2.6.6. *Let G and J be two connected graphs. Then,*

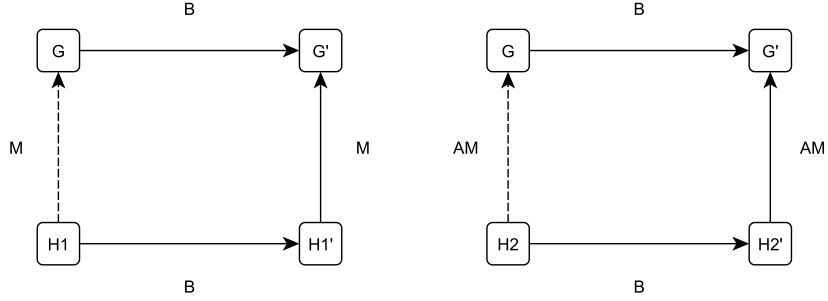

Figure 2.14: Illustration of Theorem 2.6.6

1. There exist a graph H_1 such that $M(H_1) \cong G$ and $C(H_1) \cong J$.
2. There exist a graph H_2 such that $AM(H_2) \cong G$ and $C(H_2) \cong J$.

Proof. 1. Let G' and J' are the graphs such that $B(G) = G'$ and $B(J) = J'$. From Corollary 2.6.5, we can see that there exists a graph H_1 such that $H_1' \cong B(H_1)$ with $M(H_1') = G'$ and $C(H_1') = J'$. Using Theorem 2.6.3, $M(H_1) = B^{-1}BM(H_1) = B^{-1}MB(H_1) = B^{-1}M(H_1') = B^{-1}(G') = G$. See Figure 2.14 for an illustration.

2. The proof can be obtained using the similar arguments as in (1).

□

2.7 The median problem on square of bipartite graphs

Definition 2.7.1. The **square** G^2 of a graph G has the same vertex set as G and two vertices $u, v \in V(G^2)$ are adjacent if $d_G(u, v) \leq 2$.

Lemma 2.7.2. For a vertex $u \in V(G)$, $S_{G^2}(u) = \frac{1}{2}(S_G(u) + |O_u|)$, where $|O_u|$ is the number of vertices at odd distance from u in G .

Proof. For a vertex $u \in V(G)$, let O_u be the set of all vertices at odd distance from u . Then,

$$\begin{aligned} S_{G^2}(u) &= \sum_{v \in O_u} d_{G^2}(u, v) + \sum_{v \notin O_u} d_{G^2}(u, v) \\ &= \sum_{v \in O_u} \frac{1}{2}d_G(u, v) + \sum_{v \notin O_u} \frac{1}{2}(d_G(u, v) + 1) \\ &= \frac{1}{2}(S_G(u) + |O_u|). \end{aligned}$$

□

Remark 2.7.3. If $|O_u|$ is a constant, for all the vertices in $V(G)$, then it is immediate that the median set of G and G^2 are the same.

Definition 2.7.4. A subgraph H of G is a **square-subgraph** of G if $H^2 \cong G^2[V(H)]$.

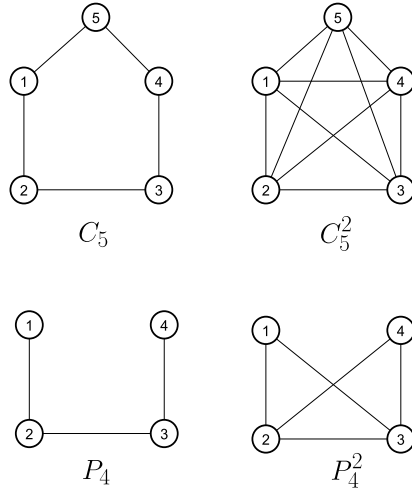

Figure 2.15: Illustration of Definition 2.7.4

Not all subgraphs of a graph are square-subgraphs. For, P_4 is not a square-subgraph of C_5 since $P_4^2 \cong K_4 - e$ is not induced in $C_5^2 \cong K_5$. The following result characterises square-subgraphs of graphs.

Lemma 2.7.5. *H is square-subgraph of G if and only if for every non-adjacent vertices $u, v \in V(H)$ with $d_G(u, v) = 2$, $N_H^*(u, v) \neq \emptyset$.*

Proof. Let H be a subgraph of G . Then, it is clear that $E(H^2) \subseteq E(G^2[V(H)])$. Let u, v be two non-adjacent vertices of H such that $d_G(u, v) = 2$. That is, $uv \in E(G^2[V(H)])$. Then H is square-subgraph of G if and only if uv is an edge in H^2 if and only if $d_H(u, v) = 2$ if and only if $N_H^*(u, v) \neq \emptyset$. \square

The following result is about the commutation of the operator $(\cdot)^2$ with $M(\cdot)$ and $AM(\cdot)$.

Theorem 2.7.6. *Let G be a graph such that $|O_u|$ is a constant for all $u \in V(G)$. If $M(G)$ and $AM(G)$ are square-subgraphs of G , then $M(G^2) = (M(G))^2$ and $AM(G^2) = (AM(G))^2$.*

Proof. Since $M(G)$ is a square-subgraph of G , $M(G)^2$ is induced in G^2 . By Remark 2.7.3, the median sets of G and G^2 are the same. \square

Remark 2.7.7. We can see that the earlier constructions on symmetric bi-partite graphs are also valid for bipartite graphs with bi-partition (X, Y) and $|X| = |Y|$. Hence the following results hold.

Corollary 2.7.8. *Let G be a bipartite graph with bi-partition (X, Y) and $|X| = |Y|$, then there are bipartite graphs H_1 and H_2 such that Median set of H_1^2 is G^2 and Anti-median set of H_2^2 is G^2 .*

Proof. The proof is by construction. By Remark 2.7.7, we apply the construction in Theorem 2.5.2 for symmetric bipartite graphs to obtain a graph H_1 such that $M(H_1) = G$. It is clear by the construction that H_1 is bi-partite with bi-partition (X', Y') and $|X'| = |Y'|$. Now by Remark 2.7.3, Median set of H_1^2 is G^2 . Similarly using the construction in Theorem 2.5.4, the second part of the assertion also follows. \square

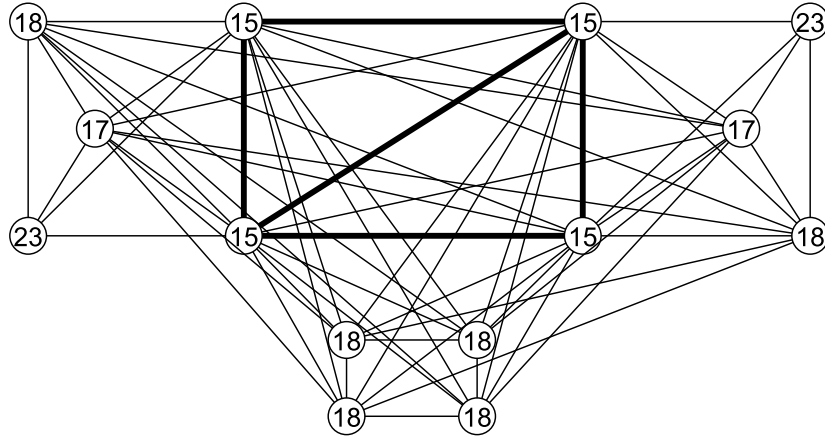

Figure 2.16: The graph of G^2 of G in Figure 2.1. We have $M(G^2) \cong (M(G))^2 \cong K_4 - e$.

Example 2.7.9. Illustration for Corollary 2.7.8

Consider $P_4^2 \cong K_4 - e$. Since P_4 has a bi-partition (X, Y) with $|X| = |Y|$, by Corollary 2.7.8, there exist a graph G such that $M(G^2) \cong P_4^2$. Consider the graph G with $M(G) \cong P_4$ in Figure 2.1. The construction of the graph G satisfies the construction rules for symmetric bipartite graphs. Now, Figure 2.16 shows the graph of G^2 and the status of the vertices in it. It is not difficult to see that $M(G^2) \cong P_4^2$.

Chapter 3

Convex Median and Anti-Median at Prescribed Distance

In this chapter, we provide an upper bound to the maximum status difference in a graph. An optimal solution to the problem of simultaneous embedding of two graphs as the median and anti-median subgraphs of a graph is also given¹.

¹Some results in this chapter are in the publication 'K. Pravas, A. Vijayakumar, Convex median and anti-median at prescribed distance, J. Comb. Optim.(2016), 1-9.'

3.1 An upper bound to maximum status difference in a graph

For any vertex v in a graph G on n vertices, $n - 1 \leq S_G(v) \leq n(n - 1)/2$. Hence, an obvious upper bound for $SD(G)$ is $\frac{(n-1)(n-2)}{2}$. However, this upper bound is sharp only when the graph is P_n , $n \leq 3$, where P_n is the path on n vertices. We obtain a sharp upper bound for $SD(G)$ through the following results.

Remark 3.1.1. Let u and v be two vertices in a tree T on n vertices and T_{n_1} be the component containing u in $T \setminus v$. Then $S_T(u, T \setminus T_{n_1}) - S_T(v, T \setminus T_{n_1}) = d(u, v)|V(T \setminus T_{n_1})|$. This is because, for any vertex x not in T_{n_1} , $d(u, x) = d(u, v) + d(v, x)$.

Theorem 3.1.2. For a graph on n vertices, $SD(G) \leq \frac{n^2 - 2n + 1}{4}$, when n is odd and $SD(G) \leq \frac{n^2 - 2n}{4}$ when n is even.

Proof. We first note that for any connected graph G , a BFS tree T from a median vertex of G has $SD(T) \geq SD(G)$. Thus the problem of finding the maximum of $SD(G)$ has been reduced to the corresponding problem on trees.

Let T be a tree on n vertices which has the maximum status difference over all trees on n vertices. Let u be an anti-median vertex and v be a median vertex in T . Let P be the path connecting u and v in T . First, we show that the shortest path from u to any vertex in $T \setminus P$ must pass through v . For, otherwise, we can find a vertex w of degree one such that the shortest path from u to w is not through v . Let t be the vertex in P such that it is in both the shortest paths from u to w and v to w . Also, $d(v, t) \geq 1$. Consider a tree T' , formed from T by deleting w and attaching a pendant vertex w' to v . Then $SD(T') = SD(T) + d(u, v) - d(u, t) + d(v, t)$. Since $d(u, t) < d(u, v)$, $SD(T') > SD(T)$ is a contradiction. Since u is an anti-median vertex, it is a peripheral vertex in T [10].

Now form a tree T'' by deleting all the vertices of T in $T \setminus P$ and attaching a path of length $n - |V(T \setminus P)|$ to v . Clearly $T'' \cong P_n$ and u is again an anti-median vertex. By Remark 3.1.1, $S_T(u) - S_T(v) = S_{T''}(u) - S_{T''}(v)$. If v is not a median vertex in T'' , then for some median vertex v_m of T'' , $SD(T) = S_{T''}(u) - S_{T''}(v) < S_{T''}(u) - S_{T''}(v_m) = SD(T'')$, which contradicts the choice of T . Hence $SD(T) = SD(T'') = SD(P_n)$. Now, the assertion follows. \square

3.2 Embedding convex subgraphs at prescribed distance

Let G_1 and G_2 be any two connected graphs and $r \geq 1$. The following constructions will provide a graph H_0 with the property that both G_1 and G_2 are convex subgraphs of H_0 and $d_{H_0}(G_1, G_2) = r$.

Observation 3.2.1. *Let f be an isomorphism between two graphs C_1 and C_2 , of order k , with $f(x_i) = y_i$, $x_i \in V(C_1)$, $y_i \in V(C_2)$, $i = 1, \dots, k$. Let H be a graph obtained by joining C_1 and C_2 with k disjoint paths of length r , each with one end at x_i and other end at y_i . Then C_1 and C_2 are convex subgraphs of H and $d_H(C_1, C_2) = r$.*

Let $D > \max\{r, d(G_1)/2, d(G_2)/2\}$ and $D \in \mathbb{Z}^+$. Now, introduce four vertices a_i , for $i = 1, 2, 3$ and 4 , and make the connections as follows.

Step 1:

- (1-a) For each vertex x in G_1 , introduce disjoint paths P_{xa_i} with one end at x and the other end at a_i , for each i , of length D . Also, for each vertex y in G_2 , introduce paths P_{ya_1} and P_{ya_2} of length $D + 1$.

- (1-b) Introduce paths $P_{a_1a_2}, P_{a_1a_4}, P_{a_2a_3}$ and $P_{a_3a_4}$ of length $2D$; $P_{a_1a_3}$ and $P_{a_2a_4}$ of length $r + 1$. The subgraph induced by the vertices in these six paths is denoted by \boxtimes . (See Figures 3.1 and 3.2).

In Step 1, we introduced $4n_1 + 2n_2 + 6$ vertex disjoint paths and in Step 2 we make some vertices in them adjacent. To identify the vertices in such paths, we use the following terminologies. Let P_{uv} be a path from u to v introduced in Step 1 of the construction of H_0 . Then the vertex, in P_{uv} , which is at a distance of i from u is denoted by $P_{uv}[i]$. Thus $P_{uv}[0]$ represents the vertex u itself and $P_{uv}[1]$ is the vertex, in P_{uv} , which is adjacent to u .

Step 2: For each $y \in V(G_2)$, construct the edges $\{P_{ya_1}[1], P_{ya_2}[1]\}$, $\{P_{ya_1}[D], P_{a_3a_1}[r - 1]\}$ and $\{P_{ya_2}[D], P_{a_4a_2}[r - 1]\}$.

Step 3:

- (3-a) Choose two non-negative integers p and q such that $p = q = r/2$ when r is even and $p = q + 1 = (r + 1)/2$ when r is odd. In both the cases $p - q \leq 1$ and $p + q = r$.
- (3-b) Let C_1 and C_2 be two isomorphic convex subgraphs of k vertices, of G_1 and G_2 respectively. Such subgraphs always

exist as K_1 is always a convex subgraph of a graph. Let f be an isomorphism from C_1 to C_2 , defined by $f(x_i) = y_i$, where $x_i \in V(C_1)$ and $y_i \in V(C_2)$ for $i = 1, 2, \dots, k$. Now for each x_i , $i = 1, 2, \dots, k$, construct the edges $\{P_{x_i a_1}[p-1], P_{y_i a_1}[q]\}$.

Call the graph as H_0 (Fig. 3.1). Now, we have the following remark.

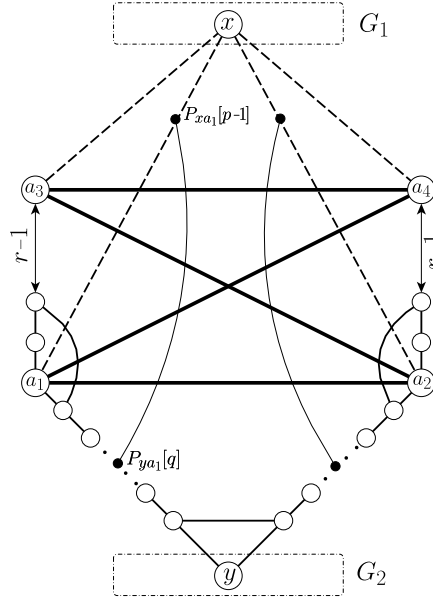

Figure 3.1: The graph H_0 . Here the solid lines are of length $2D$ and dashed lines are of length D . The solid line paths and the paths of length $r+1$ induce the subgraph denoted by \boxtimes , given in Step 1(b). Here the numbers $p-1$ and q are chosen as per Step (3-a) of the construction.

Remark 3.2.2. In the graph H_0 , for each vertex $x \in V(G_1)$, $y \in V(G_2)$ and a_i , for $i = 1, 2, 3$ and 4 ,

1. $d(x, a_i) = D$.
2. $d(y, a_1) = d(y, a_2) = D + 1$ and $d(y, a_3) = d(y, a_4) = D + r$.
3. $d(G_1, G_2) = r$.

Theorem 3.2.3. *The graphs G_1 and G_2 are convex subgraphs of H_0 .*

Proof. Assume that G_1 is not a convex subgraph of H_0 . Then there exists a shortest path P between two vertices x_1 and x_2 of G_1 such that P contains a vertex not in G_1 . If P includes any of the vertices a_i , which are at a distance D from G_1 , then $d(x_1, x_2) \geq 2D > d(G_1)$, is a contradiction. So, let P does not include any of the a_i 's. Then P must include edges of the form $\{P_{x_k a_i}[q], P_{y_k a_i}[p - 1]\}$, where $x_k \in V(C_1)$, $f(x_k) = y_k \in V(C_2)$, $i = 1, 2, 3$ or 4 . But in this case P includes two vertices x' and $x'' \in V(C_1)$, and such edges, which are not in C_1 , are included in the shortest path between x' and x'' . This contradicts the convexity of C_1 . Hence such a path P does not exist and the proof follows.

Similar arguments prove that G_2 is also a convex subgraph of H_0 . □

3.3 Construction of the graph H_N

Step 4: Introduce the vertices a_i^* , for $i = 1, 2, 3$ and 4 , in H_0 , and construct the edges $\{a_i^*, a_i\}$, for all i , and $\{a_1^*, P_{a_1 a_4}[1]\}$,

$\{a_2^*, P_{a_2a_1}[1]\}$, $\{a_3^*, P_{a_3a_2}[1]\}$ and $\{a_4^*, P_{a_4a_3}[1]\}$ (Fig. 3.2). The graph so constructed is denoted by H_1 .

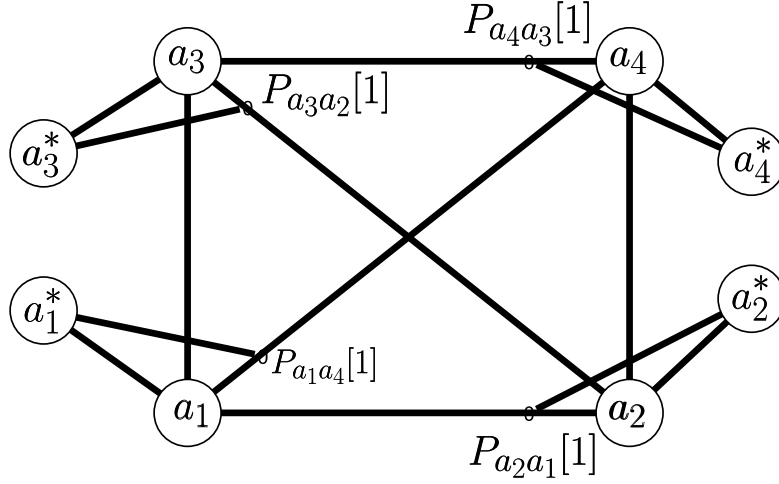

Figure 3.2: The subgraph \boxtimes , given by step 1(b), and the edges from a_i^* as per step 4 of the construction.

Lemma 3.3.1. *In the graph H_1 , the sum of the distances to the vertices a_i^* is the minimum for all the vertices in G_1 and is maximum for all the vertices in G_2 .*

Proof. For a vertex u in H_1 , consider $S_{H_1}(u, A)$, where $A = \{a_1^*, a_2^*, a_3^*, a_4^*\}$. Now, we have the following cases.

Case 1 $x \in V(G_1)$. By Lemma 3.2.2, $S_{H_1}(x, A) = 4D + 4$.

Case 2 $y \in V(G_2)$. Again by Lemma 3.2.2, $S_{H_1}(y, A) = 4D + 2r + 6$.

Case 3 $u \in V(P_{xa_1})$. Let $d(a_1, u) = k$, where $0 < k < D$. Now, there are two sub cases.

Case 3.1 When $k \leq D - (\frac{r+1}{2})$, we have $d(u, a_1) = k$, $d(u, a_2) = 2D - k$, $d(u, a_3) = k + r + 1$, $d(u, a_4) = 2D - k$ and hence $S_{H_1}(u, A) = 4D + r + 5$.

Case 3.2 When $k > D - (\frac{r+1}{2})$, $d(u, a_1) = k$ and $d(u, a_i) = 2D - k$ for $i = 2, 3, 4$. So that $S_{H_1}(u, A) = 6D - 2k + 4$.

The cases when $u \in V(P_{xa_i})$ for $i = 2, 3$ and 4 are similar as above.

Case 4 $u \in V(P_{a_1a_3})$.

Let $d(a_1, u) = k$, where $0 < k < 2D$. If $k < \frac{r}{2}$ then $d(u, a_1) = k$, $d(u, a_2) = k + 2D$, $d(u, a_3) = r - k + 1$ and $d(u, a_4) = k + 2D$ so that $S_{H_1}(u, A) = 4D + r + k + 4$. When $k \geq \frac{r}{2}$, all the measures are as above except with $d(u, a_4) = r - k + 2D$ and hence $S_{H_1}(u, A) = 4D + 2r + 3$.

The case when $u \in V(P_{a_2a_4})$ is similar as above.

Case 5 $u \in V(P_{a_1a_2})$.

Let $d(a_1, u) = k$, where $0 < k < 2D$. Then $d(u, a_1) = k$, $d(u, a_2) = 2D - k$, $d(u, a_3) = k + r + 1$ (or $4D - k$ when $k > 2D - \frac{r+1}{2}$) and $d(u, a_4) = 2D - k + r + 1$ (or $k + 2D$ when $k < \frac{r+1}{2}$).

The case when $u \in V(P_{a_3a_4})$ is similar as above.

Case 6 When u is a_i or a_i^* , for $i = 1, 2, 3$ and 4 , it can be verified that $S_{H_1}(u, A) = 4D + r + 4$.

Thus $S_{H_1}(x, A) < S_{H_1}(u, A) < S_{H_1}(y, A)$ for any vertex $u \notin V(G_1) \cup V(G_2)$, where $x \in V(G_1)$ and $y \in V(G_2)$. \square

Step 5: For a positive integer N , the graph H_N is obtained from H_1 as follows.

(5-a) Replace the vertex a_i^* with a complete graph K_N . Let A_i^* denote the set of vertices in K_N .

(5-b) Each vertex in A_i^* is made adjacent to the neighbors of a_i^* , in H_1 .

See Fig.3.3 for an example.

Remark 3.3.2. Since any vertex in A_i^* , for all i , is a simplicial vertex in H_N , no shortest path between the vertices in H_{N-1} include a vertex in $H_N \setminus H_{N-1}$. In effect, $d_{H_k}(x, y) = d_{H_N}(x, y)$, $\forall x, y \in V(H_k)$, $0 \leq k \leq N$.

Then, $S_{H_N}(x) = \begin{cases} S_{H_0}(x) + NS_{H_1}(x, A) & \text{when } x \in V(H_0) \\ S_{H_1}(a_i^*, H_0) + NS_{H_1}(a_i^*, A) & \text{when } x \in A_i^*, \forall i \end{cases}$

and, for $k \geq 0$,

$$S_{H_{N+k}}(x) - S_{H_N}(x) = \begin{cases} kS_{H_1}(x, A) & \text{when } x \in V(H_0) \\ kS_{H_1}(a_1, A) & \text{when } x \in V(H_{N+k} \setminus H_0) \end{cases}.$$

3.4 Convex subgraphs with equal status

Let x_m be a vertex in $V(G_1)$ such that $S_{H_N}(x_m) = \min_{x_i \in V(G_1)} S_{H_N}(x_i)$.

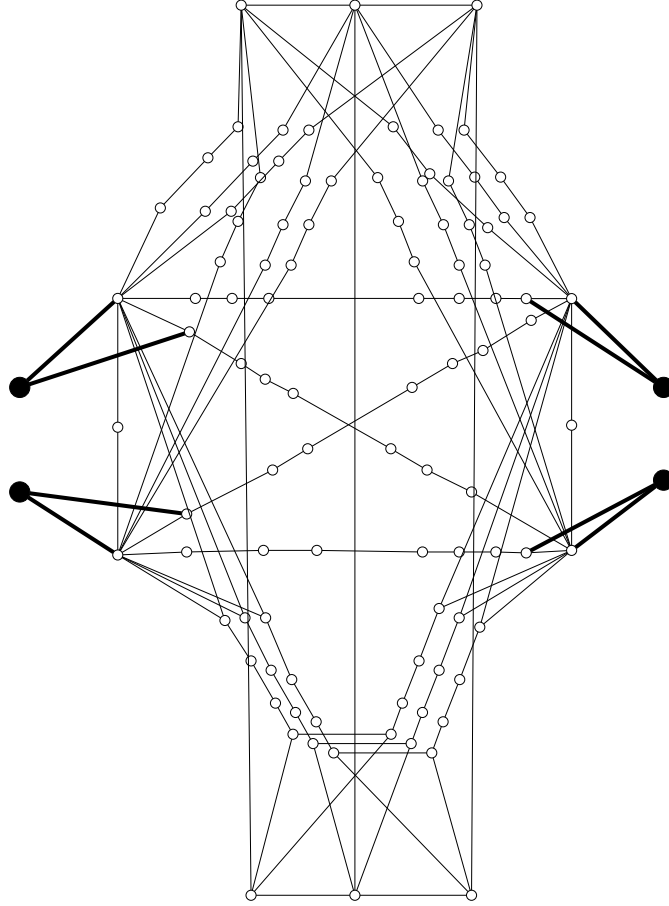

Figure 3.3: A graph H_N in the construction of $(P_3, P_3, 1)$, in which $|V(H_0)| = 100$. Here the black vertices represent complete graphs of size N and solid edges denote all possible edges between the nodes.

Step 6:

(6-a) For each vertex $x_i \in V(G_1)$, choose integers c_{i1}, c_{i2}, c_{i3} and

$$c_{i4} \text{ such that } \sum_{j=1}^4 c_{ij} = S_{H_N}(x_i) - S_{H_N}(x_m) \text{ and } |c_{ij} - c_{ik}| \leq$$

1, where $j, k \in \{1, 2, 3, 4\}$.

(6-b) For each $x_i \in V(G_1)$ and $j, j = 1, 2, 3, 4$, join $P_{a_j, x_i}[1]$ to c_{ij} vertices of A_j^* . The newly obtained graph from H_N is referred to as J_N .

Remark 3.4.1. As per step 6, for each $x_i \in V(G_1)$ and $j, j = 1, 2, 3, 4$, $P_{a_j, x_i}[1]$ is joined to c_{ij} vertices of A_j^* . Thus the size of A_j^* should be at least $\max c_{ij}$. Since the size of A_j^* is N in H_N , and step 7 also has a similar requirement, we assume that N is large enough to apply the requirements in step 6 and 7.

Theorem 3.4.2. *In J_N , all the vertices of $V(G_1)$ have equal status.*

Proof. Let x_i be a vertex in G_1 . If we join the vertex $P_{a_1, x_i}[1]$ to one of the vertices in A_1^* , in H_N , then in the new graph the sum of the distances from x_i to A_1^* becomes one less than that in H_N . Therefore joining $P_{a_1, x_i}[1]$ to c_{i1} vertices of A_1^* decreases the status of x_i by c_{i1} . Hence, for each vertex $x_i \in V(G_1)$,

$$\begin{aligned} S_{J_N}(x_i) &= S_{H_N}(x_i) - \sum_{j=1}^4 c_{ij} \\ &= S_{H_N}(x_i) - (S_{H_N}(x_i) - S_{H_N}(x_m)) \\ &= S_{H_N}(x_m). \end{aligned}$$

□

Remark 3.4.3. Since $d(f(x_i), x_i) = r$, for each x_i in C_1 , the status of the corresponding vertices $f(x_i)$ also get reduced by $\sum_{j=1}^4 c_{ij}$.

Let y_m be a vertex in $V(G_2)$ such that $S_{J_N}(y_m) = \min_{y_i \in V(G_2)} S_{J_N}(y_i)$.

Step 7:

- (7-a) For each vertex $y_i \in V(G_2)$, choose integers c_{i5} and c_{i6} such that $c_{i5} + c_{i6} = S_{J_N}(y_i) - S_{J_N}(y_m)$ and $|c_{i5} - c_{i6}| \leq 1$.
- (7-b) For each $y_i \in V(G_2)$ join $P_{a_1, y_i}[1]$ to c_{i5} vertices of A_1^* and $P_{a_2, y_i}[1]$ to c_{i6} vertices of A_2^* . Call this modified graph as J'_N .

Theorem 3.4.4. *In J'_N , all the vertices of $V(G_2)$ have equal status.*

Proof. The proof is similar to that of Theorem 3.4.2. \square

Lemma 3.4.5. *When $N \geq |V(H_0)|^4/4$, $M(J'_N) \cong G_1$, $AM(J'_N) \cong G_2$ and $d(G_1, G_2) = r$.*

Proof. The steps 6 and 7 in the construction of J'_N from H_N also ensure that Lemma 3.3.1 is valid in J'_N . For $k \geq 0$, a similar calculation as in Remark 3.3.2 leads to

$$S_{J'_{N+k}}(x) - S_{J'_N}(x) = \begin{cases} kS_{H_1}(x, A) & \text{when } x \in V(H_0) \\ kS_{H_1}(a_1, A) & \text{when } x \in V(J'_{N+k} \setminus H_0) \end{cases}.$$

Now, for large N (the value of N is discussed in the next section), the assertion follows. \square

3.5 The value of N

In this section we discuss the value of N so that J'_N is a (G_1, G_2, r) graph. Let n_1 and n_2 be the sizes of G_1 and G_2 respectively. Then,

$$\begin{aligned} |V(H_0)| &= n_1 + n_2 + 4 + 4n_1(D-1) + 2n_2D + 2r + 4(2D-1) \\ &= n_1(4D-3) + n_2(2D+1) + 8D + 2r. \end{aligned} \quad (3.5.0.1)$$

By Theorem 3.1.2 and Remark 3.3.2, $SD_{H_N}(G_i) = SD_{H_0}(G_i) \leq |V(H_0)|^2/4$, for $i = 1, 2$. Thus in the construction of J_N , N is at most $|V(H_0)|^2/4$. By Remark 3.4.3, $SD_{J_N}(G_2) \leq SD_{H_N}(G_2) + SD_{H_N}(G_1)$ and hence, for J'_N , N is at most $|V(H_0)|^2/2$.

Let N_1 be the minimum value such that the vertices in G_1 have the minimum status and the vertices in G_2 have the maximum status in J'_{N_1} . Since $|V(J'_N)| \leq |V(H_0)|^2/2$, we have $SD(J'_N) \leq |V(H_0)|^4/4$. By Lemma 3.3.1, we need $N_1 \geq |V(H_0)|^4/4$.

Remark 3.5.1. The number of vertices used in the construction can be reduced using a suitable choice of convex isomorphic subgraphs in G_1 and G_2 . The larger the convex graphs, the smaller the value of $SD(J'_N)$, as there will be more paths of

length r between G_1 and G_2 . Also, when the diameters of the graphs are too large, more than one convex isomorphic graphs may be selected from each of G_1 and G_2 .

For instance, when G_1 or G_2 is disconnected, choose isomorphic convex subgraphs from each component of G_1 and G_2 in the construction of H_0 . Let f_{ij} be the isomorphism between the convex subgraphs C_i in G_1 and C_j in G_2 . Modify step 3 of the construction of H_0 for each isomorphism f_{ij} and thus making more paths of length r between G_1 and G_2 .

Thus our construction works even when G_1 and G_2 are disconnected. Also, with this modification, $G_1 \cup G_2$ is convex in $(G_1, G_2, 1)$.

Example 3.5.2. An illustration to the construction of $(P_3, P_3, 1)$ is given below.

Let $G_1 \cong G_2 \cong P_3$ with $V(G_1) = \{1, 2, 3\}$ and $V(G_2) = \{4, 5, 6\}$. Choose $r = 1, D = 4$. By, Equation 3.5.0.1, $|H_0| = 100$. The constructed \boxtimes graph is given in Figure 3.4. The labels of the a_i vertices are $a_1 = 97, a_2 = 98, a_3 = 99$ and $a_4 = 100$.

Now, the graph H_1 contains 104 vertices with vertex labels for a_i^* from 101 to 104, for $i=1$ to 4, respectively. In the construction of H_2 , the sets A_i^* are appended with the vertices 105 to 108, for $i=1$ to 4, respectively.

The graph H_2 so constructed is given in Figure 3.5. For each

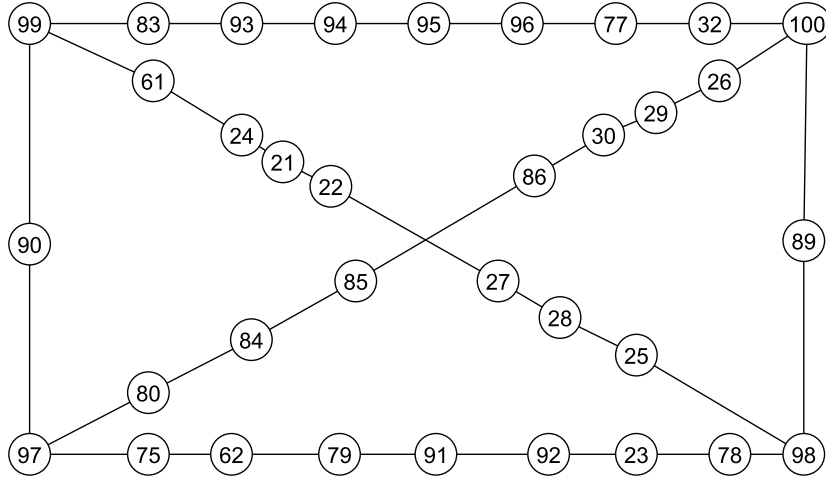

Figure 3.4: The \boxtimes graph for Example 3.5.2. Here the vertex labels are assigned as per the graph H_2 given in Figure 3.5

vertex $v \in V(H_1)$, the status values $S_{H_1}(v)$ and $S_{H_2}(v)$ and their difference $d = S_{H_2}(v) - S_{H_1}(v)$ are given in Table 3.1. It shows that the increase in the status is the minimum for the vertices in G_1 and is maximum for the vertices in G_2 . However, the status values of each of the vertices in $V(G_1)$ and $V(G_2)$ are different.

We now apply Step (6) of the construction. $S_{H_N}(2) \leq S_{H_N}(v)$ for all $v \in V(G_1)$ and $S_{H_N}(i) - S_{H_N}(2) = 20$, for $i = 1$ and 3 , implies that $c_{ij} = 5$ for each $j = 1$ to 4 . That is N should be at least 5 to apply Step 6 – b . Now, the graph J_5 so constructed is given in Figure 3.6. On calculation, we can see that the status of all the vertices in $V(G_1)$ are equal. Similarly, using Step 7,

the graph J'_N can also be obtained.

We saw that, as N increases, the increase in the status is the minimum for the vertices in G_1 and is maximum for the vertices in G_2 . That is, G_1 and G_2 become the median and the anti-median when N is large.

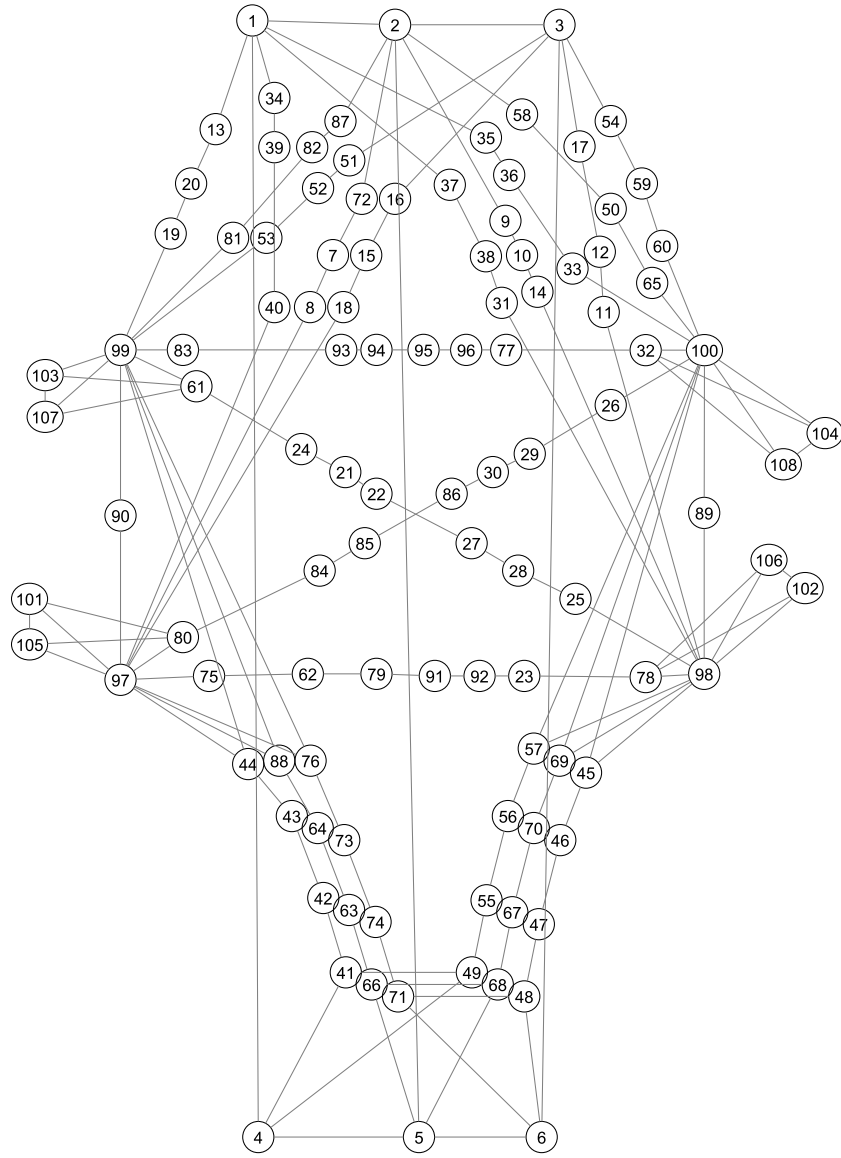
Figure 3.5: The vertex labels of graph H_2 of Example 3.5.2

v	1	2	3	4	5	6	7	8	9	10	11
$S_{H_1}(v)$	441	421	441	497	475	497	519	529	487	519	538
$S_{H_2}(v)$	461	441	461	521	499	521	541	551	509	541	560
d	20	20	20	24	24	24	22	22	22	22	22
12	13	14	15	16	17	18	19	20	21	22	23
534	505	529	534	505	505	538	538	534	665	682	626
556	527	551	556	527	527	560	560	556	688	705	649
22	22	22	22	22	22	22	22	22	23	23	23
24	25	26	27	28	29	30	31	32	33	34	35
626	565	565	665	626	626	665	538	564	538	505	505
649	588	588	688	649	649	688	560	586	560	527	527
23	23	23	23	23	23	23	22	22	22	22	22
36	37	38	39	40	41	42	43	44	45	46	47
534	505	534	534	538	518	545	550	517	517	550	545
556	527	556	556	560	540	567	572	539	539	572	567
22	22	22	22	22	22	22	22	22	22	22	22
48	49	50	51	52	53	54	55	56	57	58	59
518	518	519	505	534	538	505	545	550	517	487	534
540	540	541	527	556	560	527	567	572	539	509	556
22	22	22	22	22	22	22	22	22	22	22	22
60	61	62	63	64	65	66	67	68	69	70	71
538	564	626	532	540	529	502	532	502	516	540	518
560	586	649	554	562	551	524	554	524	538	562	540
22	22	23	22	22	22	22	22	22	22	22	22
72	73	74	75	76	77	78	79	80	81	82	83
487	550	545	565	517	626	564	665	564	529	519	565
509	572	567	588	539	649	586	688	586	551	541	588
22	22	22	23	22	23	22	23	22	22	22	23
84	85	86	87	88	89	90	91	92	93	94	95
626	665	682	487	516	537	537	682	665	626	665	682
649	688	705	509	538	559	559	705	688	649	688	705
23	23	23	22	22	22	22	23	23	23	23	23
96	97	98	99	100	101	102	103	104			
665	486	486	486	486	577	577	577	577			
688	507	507	507	507	600	600	600	600			
23	21	21	21	21	23	23	23	23			

Table 3.1: The difference in the status of the vertices in $V(H_1)$ in the graphs H_1 and H_2 .

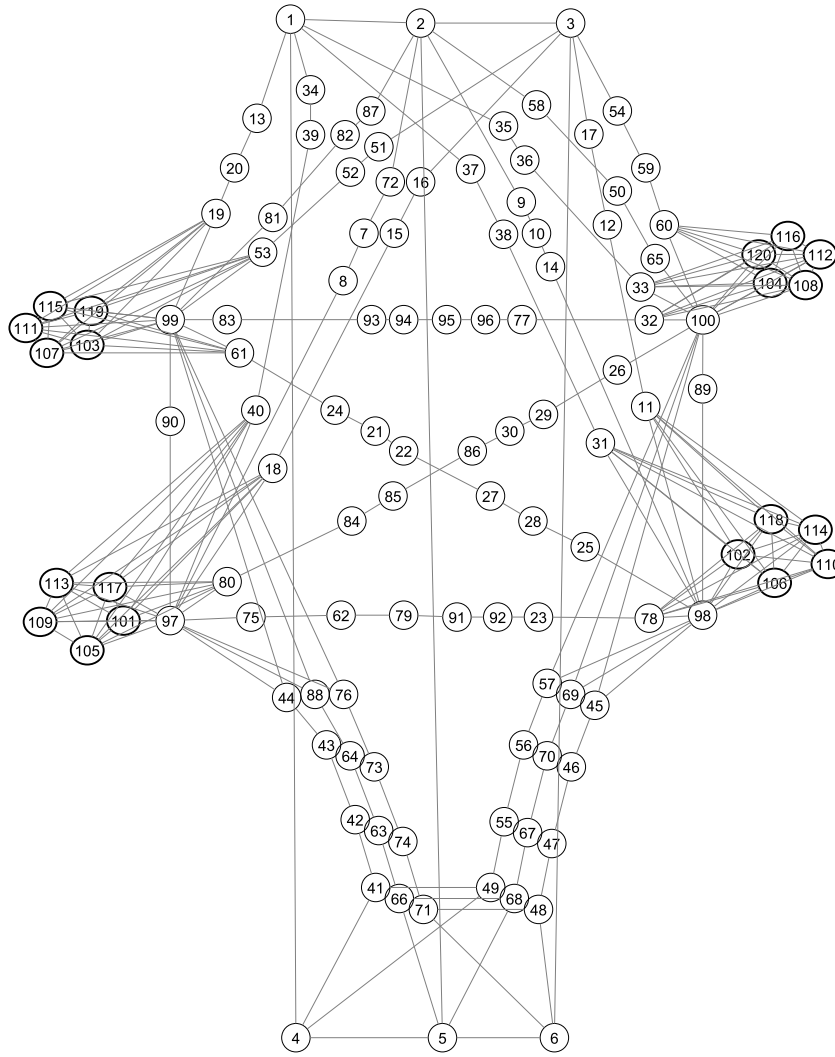
Figure 3.6: The graph J_5 of Example 3.5.2

1	2	3	4	5	6	7	8	9	10
501	501	501	573	571	573	607	617	575	607
11	12	13	14	15	16	17	18	19	20
611	607	573	617	607	573	573	611	611	607
21	22	23	24	25	26	27	28	29	30
757	774	718	718	652	652	757	718	718	757
31	32	33	34	35	36	37	38	39	40
611	652	611	573	573	607	573	607	607	611
41	42	43	44	45	46	47	48	49	50
606	633	638	605	605	638	633	606	606	607
51	52	53	54	55	56	57	58	59	60
573	607	611	573	633	638	605	575	607	611
61	62	63	64	65	66	67	68	69	70
652	718	620	628	617	590	620	590	604	628
71	72	73	74	75	76	77	78	79	80
606	575	638	633	652	605	718	652	757	652
81	82	83	84	85	86	87	88	89	90
617	607	652	718	757	774	575	604	625	625
91	92	93	94	95	96	97	98	99	100
774	757	718	757	774	757	565	565	565	565
101	102	103	104	105	106	107	108	109	110
633	633	633	633	633	633	633	633	633	633
111	112	113	114	115	116	117	118	119	120
633	633	633	633	633	633	633	633	633	633

Table 3.2: The status of the vertices in J_5 .

Chapter 4

Root line graphs of some graph classes

In this chapter, some properties of the edges in a hanging of a line graph is obtained, using which we present an algorithm to partition the edge set of a line graph $L(G)$ to the edge sets of the Gallai and anti-Gallai graphs of G . We then obtain an optimal algorithm for determining the root line graph of a given line graph. We also show that it is a recognizing algorithm for a given graph to be a line graph. Finally, the root line graphs of the graph classes such as diameter-maximal, distance-hereditary, Ptolemaic and chordal graphs are also obtained.

4.1 Adjacency properties of edges of $L(G)$

The **hanging**[14] of a graph $H = (V, E)$, with $|V| = n$ and $|E| = m$, by a vertex z is the function h_z that assigns to each vertex x of H the value $d(z, x)$. The i -th level of H in a hanging h_z is defined as $L_i = \{x \in H : h_z(x) = i\}$. A hanging can be obtained using a breadth first search(BFS) [1], which has a time complexity of $O(m + n)$.

For a vertex v in L_i , a **supporter** of v is a vertex in L_{i-1} , which is adjacent to v . A vertex in L_i is an ending vertex if it has no neighbors in L_{i+1} . An arbitrary supporter of v is denoted by $S(v)$. It is clear that any vertex v in the level L_i for $i \geq 1$ has at least one supporter.

We use the following, well known, forbidden subgraph characterization of a line graph.

Theorem 4.1.1. [9] *A graph H is a line graph if and only if the nine graphs in Fig 4.1 are forbidden subgraphs for H .*

Theorem 4.1.2. *Consider a hanging of a line graph H by an arbitrary vertex in H and let uv denote the edge joining u and v in the same level L_i . Then, the following statements hold*

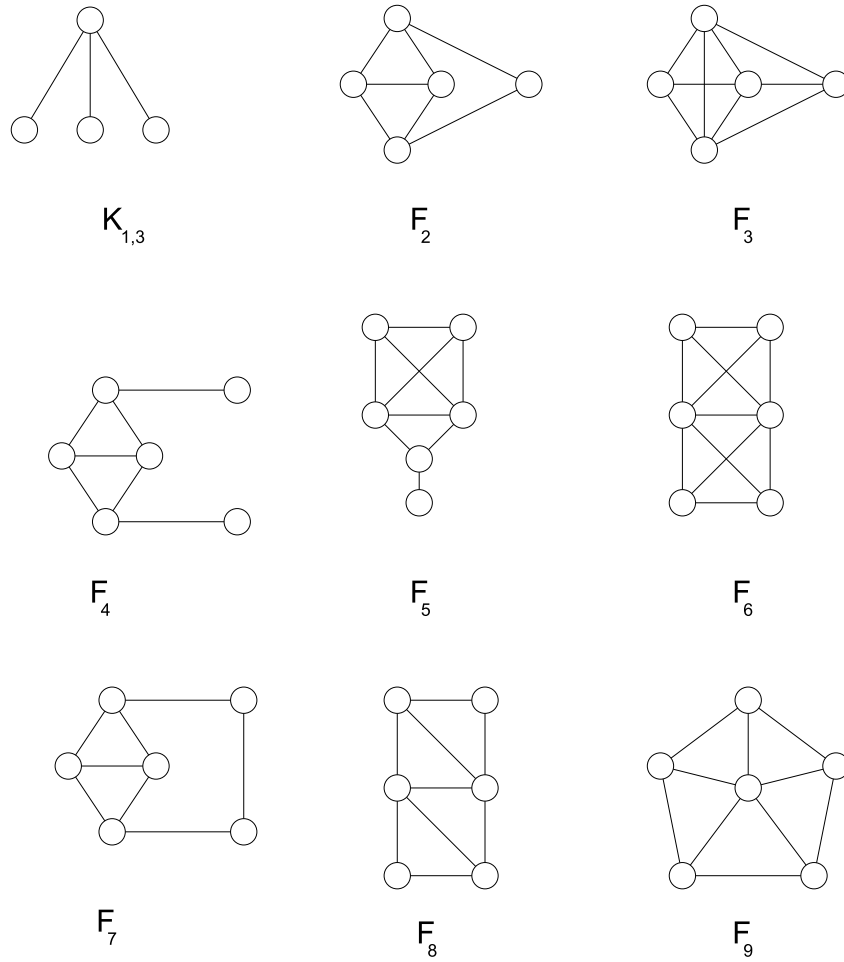

Figure 4.1: Forbidden Subgraphs of line graph.

1. All common neighbors of uv in L_{i-1} are adjacent to each other.
2. All common neighbors of uv in L_{i+1} are adjacent to each other.

3. If uv has no common neighbor in L_{i-1} , then all the common neighbors of uv in L_i which are adjacent to all other neighbors of uv are adjacent to each other.
4. There is at most one common neighbor of uv in L_i , which is adjacent to all the neighbors of uv but not adjacent to the common neighbors of uv in L_{i-1} and L_i .

Proof.

1. Let x and x' be two (distinct) common neighbors of an edge uv in L_{i-1} , then $i \geq 2$. Assume that x and x' are not adjacent. Now, if x and x' have a common neighbor w in L_{i-2} , then $\langle w, x, x', u, v \rangle \cong F_2$ in Fig 4.1 which contradicts the fact that H is a line graph. So, let w and w' be any two vertices in L_{i-2} adjacent to x and x' respectively. Then $\langle w, w', x, x', u, v \rangle \cong F_7$ or F_4 according as, w and w' are adjacent or not.
2. Let w and x be two common neighbors of an edge uv in L_{i+1} . Assume that x and w are not adjacent. Now, if z is a supporter of u in L_{i-1} , then $\langle z, u, w, x \rangle \cong K_{1,3}$, which is a contradiction.
3. Let uv has no common neighbor in the level L_{i-1} and hence $i \geq 2$. Let x and w be two common neighbors of uv in L_i

which are adjacent to all the neighbors of uv . Assume that x and w are not adjacent. Now u and v cannot have a common supporter. So let z_1 and z_2 be two supporters of u and v respectively. Since z_1 and z_2 are neighbors of uv , both x and w are adjacent to them. Now, the vertices z_1, x, w and $S(z_1)$ induce a $K_{1,3}$ which is a contradiction.

4. Assume that x and w are two nonadjacent common neighbors of uv in L_i which are not adjacent to the common neighbors of uv but adjacent to all the other neighbors of uv in L_{i-1} and L_i . So, it is clear that $i \geq 2$. Let z be a common neighbor of uv in L_{i-1} . Now u must have at least one neighbor in L_{i-1} other than the common neighbors of uv in L_{i-1} , for otherwise, the vertices u, x, w and z induce a $K_{1,3}$ which is a contradiction. Similar is the case for the vertex v . So let z_1 and z_2 be two neighbors (but not common neighbors) of u and v in L_{i-1} respectively. But, we have, $\langle S(z_1), z_1, x, w \rangle \cong K_{1,3}$, which is also a contradiction.

□

Remark 4.1.3. In fact the above theorem is applicable to a larger class of graphs than line graphs as only some of the forbidden sub graphs of line graphs are used in the proof.

4.2 Anti-Gallai triangles in $L(G)$

Let uvw be a triangle in $L(G)$ and let \bar{u}, \bar{v} and \bar{w} be the edges in G representing the vertices u, v and w respectively in $L(G)$. If the edges \bar{u}, \bar{v} and \bar{w} induce a triangle in G then the triangle uvw in $L(G)$ is referred to as an anti-Gallai triangle. All the triangles in $antiGal(G)$ need not be an anti-Gallai triangle and the number of anti-Gallai triangles in $L(G)$ is equal to the number of triangles in G . Since each edge of an anti-Gallai graph belongs to some anti-Gallai triangle, the set of all anti-Gallai triangles in $L(G)$ induces $antiGal(G)$.

We observe that it is possible to suitably re-label the edges in the root graph of $K_4 - e$ so that any triangle in $K_4 - e$ can be made an anti-Gallai triangle. It can be seen that $C_4 \vee 2K_1$ and $C_4 \vee K_1$, see Figure 4.2, also have this property. Later on we prove that these are the only graphs with these property. Hence, these graphs are not considered in the following discussions.

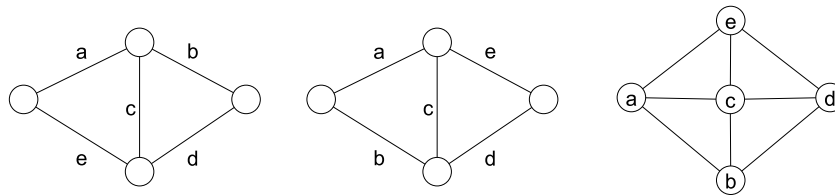

Figure 4.2: Two possible labellings of $K_4 - e$ and its line graph $C_4 \vee K_1$.

Remark 4.2.1. When a triangle uvw in $L(G)$ is not an anti-Gallai triangle, the edges \bar{u}, \bar{v} and \bar{w} in G have a vertex in common.

Lemma 4.2.2. *Consider a line graph $H \not\cong K_3$. If a triangle uvw in H is an anti-Gallai triangle, then $\langle u, v, w, x \rangle \cong K_4 - e$ or disconnected for all $x \in V(H) \setminus \{u, v, w\}$.*

Proof. Let G be the graph such that $L(G) \cong H$ and assume that the triangle uvw is an anti-Gallai triangle in H . Then the edges \bar{u}, \bar{v} and \bar{w} in G induce a triangle in G . Now corresponding to any vertex x in H , there is an edge \bar{x} in G . If \bar{x} is adjacent to the triangle $\bar{u}\bar{v}\bar{w}$, then \bar{x} is adjacent to exactly two of the edges of $\bar{u}\bar{v}\bar{w}$ and hence $\langle u, v, w, x \rangle \cong K_4 - e$ in H . If \bar{x} is not adjacent to the triangle $\bar{u}\bar{v}\bar{w}$, then $\langle u, v, w, x \rangle$ is disconnected. \square

Lemma 4.2.3. *If a triangle uvw is not an anti-Gallai triangle in a line graph $H \cong L(G)$, then there is at most one common neighbor z for an edge of uvw in H such that $\langle u, v, w, z \rangle \cong K_4 - e$.*

Proof. Let \bar{u}, \bar{v} and \bar{w} be the edges in G , representing the vertices u, v and w respectively in H . Let z be such that $\langle u, v, w, z \rangle \cong K_4 - e$ in $L(G)$ and let it be a common neighbor of uv . Then the edge \bar{z} in G is adjacent to both the edges \bar{u} and \bar{v} and not adjacent to \bar{w} . clearly \bar{u}, \bar{v} and \bar{z} induce a triangle in G and hence uvw is an anti-Gallai triangle in $L(G)$. Now assume that z' is a

vertex different from z such that it is a common neighbor of uv and $\langle u, v, w, z' \rangle \cong K_4 - e$. Then the vertices z and z' cannot be adjacent, otherwise $\langle u, v, z, z' \rangle \cong K_4$ and by Lemma 4.2.2 it will contradict the fact that u, v, z is an anti-Gallai triangle. But, we have, $\langle u, w, z, z' \rangle \cong K_{1,3}$ and hence H cannot be a line graph by Theorem 4.1.1. \square

Theorem 4.2.4. *Consider a line graph $H \not\cong K_3, K_4 - e, C_4 \vee K_1$ and $C_4 \vee 2K_1$. A triangle uvw in H is an anti-Gallai triangle if and only if $\langle u, v, w, x \rangle \cong K_4 - e$ or disconnected for all $x \in V(H) \setminus \{u, v, w\}$.*

Proof. Let G be the graph such that $L(G) \cong H$. The necessary part of the theorem follows from Lemma 4.2.2.

Conversely, assume that uvw is a triangle in H such that $\langle u, v, w, x \rangle \cong K_4 - e$ or disconnected for all $x \in V(H)$ and that uvw is not an anti-Gallai triangle. Then the edges \bar{u}, \bar{v} and \bar{w} induce a $K_{1,3}$ in G . Note that any vertex which induces a $K_4 - e$ with the triangle uvw is adjacent to exactly two vertices among u, v and w . Now, since H is connected and not a K_3 , there is a vertex x adjacent to the triangle uvw . Assume that x is adjacent to u and w . Then in G , \bar{u}, \bar{v} and \bar{x} induce a triangle so that uwx is an anti-Gallai triangle. Since $H \not\cong K_4 - e$ and also connected, there is a vertex y adjacent to at least one of the vertices u, v, w and x . If there is no vertex adjacent to the triangle uvw , then it must be adjacent to x alone, which is a contradiction to the fact

that uwx is anti-Gallai triangle. So let y be adjacent to uvw . By Lemma 4.2.3 y cannot be adjacent to u and w . So let y be adjacent to v and w . Now we have $vw y$ is also an anti-Gallai triangle. But, since $H \not\cong C_4 \vee K_1$ and connected, using the same arguments as before, we have a vertex z adjacent to the triangle uvw again. The only possibility then is that z is adjacent to the vertices u and v . Now we show that there are no more vertices possible in H . If not, let p be a vertex in H different from u, v, w, x, y and z . But, by Lemma 4.2.3, the vertex p cannot be adjacent to uvw . Now if p is adjacent to x , it must be adjacent to u or w as uwx is an anti-Gallai triangle, which again is not possible. Similarly, p cannot be adjacent to y and z . Hence no such vertex p can be adjacent to any of the vertices u, v, w, x, y and z . So such a vertex does not exist in H , as H is a connected graph. Now we have $H \cong \langle u, v, w, x, y, z \rangle \cong C_4 \vee 2K_1$, which is a contradiction. \square

Definition 4.2.5. A triangle in a hanging of a line graph is an $L\Delta$ ($M\Delta$, $R\Delta$) if it is an anti-Gallai triangle and it is induced by two vertices in one level and one vertex from the lower (same, higher) level of the ordering.

We can see that any anti-Gallai triangle is either an $L\Delta$, $M\Delta$ or $R\Delta$ in a hanging of $L(G)$.

Theorem 4.2.6. *Let uv be an edge in any level of a hanging of*

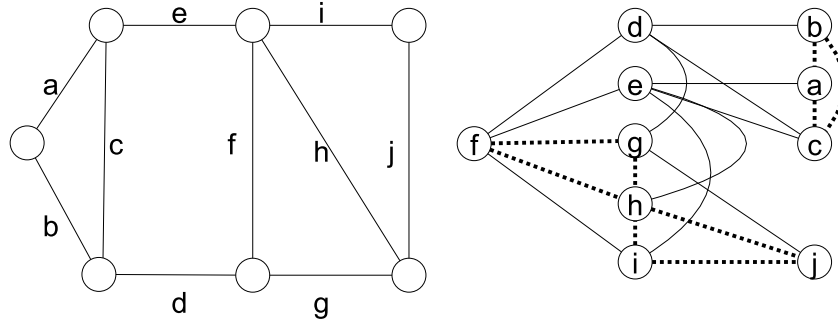

Figure 4.3: A graph and the hanging of its line graph by vertex f . The dotted lines show an $L\Delta fgh$, $R\Delta hij$ and an $M\Delta abc$.

$H \cong L(G)$ by an arbitrary vertex in H , then

1. uv cannot be an edge of an $L\Delta$ in any level L_i for $i > 1$.
2. uv cannot be an edge of an $M\Delta$ in L_1 .
3. If uv is an edge in an $M\Delta$ then uv cannot be an edge of an $L\Delta$.
4. If uv is an edge in an $M\Delta$ then uv cannot be an edge of an $R\Delta$.
5. If uv is an edge in an $L\Delta$ then uv cannot be an edge of an $R\Delta$.
6. uv can be an edge of at most one $L\Delta$ or $R\Delta$ or $M\Delta$.

Proof.

1. Let uv be an edge in an L_i for $i > 1$ and let it belong to an $L\Delta uvx$, where $x \in L_{i-1}$. Let w be the vertex in

L_{i-2} which is adjacent to x . Then $\langle w, x, u, v \rangle$ induces a subgraph which is neither a $K_4 - e$ nor disconnected, which is a contradiction.

2. Let uvx be an $M\Delta$ in L_1 and z be the vertex, from where the hanging of H being considered. Then $d(z) \geq 3$ and $\langle z, x, u, v \rangle$ induce a K_4 and hence uvx cannot be an anti-Gallai triangle, which is a contradiction.
3. Let uv be an edge in $L\Delta$ then uv is in L_1 by (1) and hence uv cannot be an edge of an $M\Delta$ by (2).

From (3) and Theorem 4.2.4, it follows that anti-Gallai triangles of a graph cannot share an edge in a line graph. Hence the proof of (4) to (6) follows.

□

Now, Lemma 4.2.7 follows.

Lemma 4.2.7. *Exactly one triangle of a $K_4 - e$ in a line graph is an anti-Gallai triangle.*

From Theorems 4.1.2 and 4.2.4, we have the following propositions.

Proposition 4.2.8. *The edge uv is in an $L\Delta$, with both its ends in the same level of a hanging of a line graph if and only if it satisfies the following conditions.*

1. Each vertex in L_1 is either adjacent to u or v but not to both.
2. Each neighbor of uv in L_2 is a common neighbor of uv .

Proposition 4.2.9. *The edge uv is in an $M\Delta$ in a hanging of a line graph if and only if it satisfies the following conditions.*

1. The edge uv has a common neighbor x in L_i which is not adjacent to the other common neighbors of uv in L_{i-1} and L_i .
2. Either u or v is adjacent to each neighbor of x .
3. Each non neighbor of x is either a common neighbor of uv or not a neighbor of uv .

Proposition 4.2.10. *The edge uv is in an $R\Delta$ with both its ends in the i^{th} level of a hanging of a line graph if and only if it satisfies the following conditions.*

1. The edge uv has exactly one common neighbor x in L_{i+1} .
2. The vertex x is an ending vertex.
3. Either u or v is adjacent to each neighbor of x .
4. Each non neighbor of x in $L_{i-1} \cup L_i$ is either a common neighbor of uv or not a neighbor of uv .

4.3 Partitioning the edges of a line graph

We now provide an algorithm to partition the edge set of a line graph into edge sets of its Gallai and anti-Gallai graphs. The three tests for an edge $uv \in L_i$ are described as follows.

Algorithm 4.3.1. $L\Delta$ test.

1. If $i \neq 1$ go to step 7.
2. Find $N(u)$ and $N(v)$.
3. If $N_{L_i}(u) \cup N_{L_i}(v) \neq L_i$ then go to step 7.
4. If $N_{L_i}(u) \cap N_{L_i}(v) \neq \emptyset$ then go to step 7.
5. If $N_{L_{i+1}}(u) \neq N_{L_{i+1}}(v)$ then go to step 7.
6. Triangle uvz is an $L\Delta$.
7. The edge uv is not in $L\Delta$.

Algorithm 4.3.2. $M\Delta$ test.

1. If $i = 1$ go to step 9.
2. Find the set C of common neighbors w_j of uv in L_i . If $C = \emptyset$, go to step 9.
3. Find the set B of common neighbors x_j of uv in L_{i-1} and L_{i+1} .

4. For each $x_j \in B$, delete the members of the set $N_C(x_j)$ from C . If $C = \emptyset$ go to step 9.
5. For each w_j , if $|N_C[w_j]| > 1$, delete the members of the set $N_C[w_j]$. If $|C| \neq 1$ go to step 9.
6. Find the set $N(uv)$ in H .
7. If $|N_C(y_j)| = 1$, for each $y_j \in N(uv) \setminus (B \cup C)$, go to step 8. Else go to step 9.
8. Triangle uvx is an $M\Delta$.
9. The edge uv is not in $M\Delta$.

Algorithm 4.3.3. $R\Delta$ test.

1. Find the set C_R of common neighbors of uv in L_{i+1} .
2. If $|C_R| \neq 1$ go to step 7. Else choose the common neighbor of uv in L_{i+1} as x .
3. If the vertex x is not an ending vertex, go to step 7.
4. Either u or v is adjacent to each neighbor of x . Else go to step 7.
5. Each non neighbor of x is either a common neighbor of uv or not a neighbor of uv . Else go to step 7.
6. Triangle uvx is an $R\Delta$.
7. The edge uv is not in $R\Delta$.

Given a line graph $H \cong L(G)$, obtain a hanging h_z by an arbitrary vertex z . Consider all the edges starting from a vertex u in L_1 . For each edge of the form uv for some $v \in L_1$, apply tests 4.3.1, 4.3.2 and 4.3.3 one by one. Choose another edge whenever an anti-Gallai triangle is found or when all the tests fail. When all the edges in a level are considered, go to the next level and repeat the procedure. This algorithm ends when all the edges in the last level of the hanging are considered and uses a time complexity of $O(m)$.

We now observe that in a line graph $L(G)$, any edge that is in the edge set of $antiGal(G)$ belongs to some anti-Gallai triangle. Hence the set of all the edges of the anti-Gallai triangles gives the edge set of $antiGal(G)$ and the remaining edges of the $L(G)$ corresponds to the edge set of $Gal(G)$.

4.4 An algorithm to find the root graph of a line graph

An optimal algorithm to recognize a line graph and output its root graph can be seen in [31], the time complexity of which is $O(n) + m$. Using the above edge partition, an algorithm, which uses a time complexity of $O(m) + O(n)$, is provided to find the

root graph of a line graph H . The same algorithm can be used as a recognition algorithm for line graphs. For this, applying the above tests for an arbitrary graph, we call a triangle type A if it belongs to the category of anti-Gallai triangles, in the above algorithm, and type B otherwise.

Algorithm 4.4.1. Root graph of a line graph

Consider the graph $H = (V, E)$ with $|V| = n$, $|E| = m$ and its hanging h_z , by an arbitrary vertex z .

Let $M = \{z, u\}$, where u is a neighbor of z . Let G be a path on three vertices with $V(G) = \{\{z\}, \{z, u\}, \{u\}\}$ and $E(G) = \{(\{z\}, \{z, u\}), (\{z, u\}, \{u\})\}$. Here the labels of vertices of G are represented as sets which can be re-labeled, in the steps of the following algorithm, using set operations.

1. Choose a vertex v from $V(H) \setminus M$ with $N_M(v) \neq \emptyset$.
2. If v induces a clique in $N_M(v)$ and does not induce a type A triangle, go to step 3. Else go to step 4.
3. Make $V(G) = V(G) \cup \{v\}$, and join $\{v\}$ with a vertex $C \in V(G)$, where $C = N_M(v)$, and make $M = M \cup \{v\}$ and $C = C \cup \{v\}$. If no such vertex C exists, go to step 4.
4. Find two vertices A and B in $V(G)$ such that $A \cup B = N_M(v)$ and make $M = M \cup \{v\}$, $A = A \cup \{v\}$ and $B = B \cup \{v\}$. Go to step 1.

The algorithm ends whenever $M = V(H)$ or there does not exist C or A and B as required. Here the graph G represents the root graph of the line graph H and in the latter case it can be concluded that the graph H is not a line graph of any graph.

The correctness of the algorithm can be verified with the help of the following theorem due to Krausz [28].

Theorem 4.4.2. *A graph H is a line graph if and only if it has an edge clique cover \mathcal{E} such that both the following conditions hold:*

1. *Every vertex of H is in exactly two members of \mathcal{E} .*
2. *Every edge of H is in exactly one member of \mathcal{E} .*

Since the vertex labels of G are represented as sets, a vertex in $\langle M \rangle$ is an element of some vertex label(set), of G . Here the elements of each vertex label in $V(G)$ induce a clique in $\langle M \rangle$ of H , since x, y are in a vertex label of G if and only if x and y are adjacent in $\langle M \rangle$ of H . Now from the construction of G , each vertex of $\langle M \rangle$ is an element of exactly two vertex labels of G and also any adjacent vertices in $\langle M \rangle$ belong to a vertex label of G . Now $V(G)$ gives an edge clique cover of $\langle M \rangle$ which satisfies the two conditions given in Krausz's theorem. Hence the algorithm obtains a graph G with $L(G) \cong H$ if and only if $M = V(H)$.

We now provide the difference between our algorithm and the algorithm in [31].

Given a graph H , the algorithm in [31] assumes that H is a line graph and defines a graph G such that H is necessarily the line graph of G . A comparison of $L(G)$ and H is then made to check whether the given graph is actually a line graph. The algorithm starts with two adjacent basic nodes, labeled 1-2 and 2-3, and labels the vertices in H , on the go, depending on their adjacency. The algorithm proceeds to determine all connections in G corresponding to a clique, containing the basic nodes in H , simultaneously finding an anti-Gallai triangle $\{1-2, 2-3, 1-3\}$, if it exists. In each step, the cliques sharing the vertices, which are already worked out, are considered and the algorithm finally outputs a labeled graph G .

In our algorithm, the types of triangles are found using the first three algorithms, the time complexity of which is calculated as follows. We can see that a hanging of the graph H can be obtained in $O(m + n)$ steps. In each of the algorithms 1, 2 and 3 only a subset of $E(H)$ are considered (as edges between the levels are not included) and the algorithm 4, which assumes that algorithms 1, 2 and 3 are already done, finishes in $O(n)$ steps.

Hence using these algorithms the root graph of a line graph can be obtained in $O(m) + O(n)$ steps.

We can see that the edges of a line graph can be partitioned into the edge sets of Gallai and anti-Gallai graphs using the first three algorithms. That is, it can be done without knowing the root graph of the given line graph. It can also be noted, as a consequence of Theorem 4.2.4, that irrespective of the starting set M of nodes, any pre-labeled line graph H with more than four vertices gives a uniquely labeled root graph G .

4.5 Root graphs of diameter-maximal line graphs

A graph G is **diameter-maximal** [12], if for any edge $e \in E(\overline{G})$, $d(G + e) < d(G)$. An example of a diameter-maximal graph is $K_4 - e$. We can see that C_4 is not diameter maximal.

Theorem 4.5.1. [12] *A connected graph G is diameter-maximal if and only if*

1. G has a unique pair of vertices u and v such that $d(u, v) = d(G)$.
2. The set of nodes at distance k from u induce a complete sub graph.

3. Every node at distance k from u is adjacent to every node at distance $k + 1$ from u .

Let G be a diameter maximal line graph with diameter d . Consider the hanging of G with respect to u as in Theorem 4.5.1. Let $L^* = (|L_0|, |L_1|, \dots, |L_d|)$ be the sequence thus generated from the hanging h_u .

Lemma 4.5.2. *In L^* , $|L_i| \leq 2$ for $i = 0, 1, \dots, d$.*

Proof. Clearly $|L_0| = |L_d| = 1$ in L^* . If possible, let u, v and w be three vertices in L_i for some i for $0 < i < d$. By Theorem 4.5.1, $\langle u, v, w \rangle \cong K_3$ and there exist vertices x in L_{i-1} and y in L_{i+1} such that u, v and w are adjacent to both x and y . But, then, $\langle x, u, v, w, y \rangle \cong F_3$ which is a contradiction. \square

A sequence S is forbidden in L^* if the consecutive terms of S do not appear consecutively in L^* .

Theorem 4.5.3. *For every $d \geq 3$, there exists three diameter-maximal line graphs with diameter d .*

Proof. First, we show that the sequence $(a_1, a_2, 2, a_3, a_4)$, where $a_i \in \{1, 2\}$, is forbidden in L^* . For, assuming the contrary, let $|L_i| = 2$ for some i , $2 \leq i \leq d-2$, and $L_i = \{v_1, v_2\}$. Let v_3, v_4, v_5 and v_6 be arbitrary vertices in L_j , for $j = i-2, i-1, i+1$ and $i+2$ respectively. But $\langle v_1, \dots, v_6 \rangle \cong F_4$ which is a contradiction.

With similar arguments, we see that the sequences $(a_1, a_2, 2, 2)$, $(2, 2, a_1, a_2)$ and $(2, 2, 2)$ are also forbidden in L^* , so that the

integer two appears at most twice in L^* and hence either (i) $|L_1| = |L_{d-1}| = 2$, (ii) $|L_1| = 2$ or (iii) all the entries of L^* are 1. Note that the case when L^* has $|L_{d-1}| = 2$ is not considered, as it is similar to (ii). Hence there are only three possible sequences of L^* when $d \geq 3$. As the three sequences are different and the pair (u, v) in Theorem 4.5.1 is unique, there exist exactly three diameter-maximal line graphs. \square

Corollary 4.5.4. *The root graphs of diameter-maximal line graphs with diameter d are of the form G in Table 4.1.*

Diameter	$d < 3$	$d \geq 3$
G		

Table 4.1: Graph G , for Corollary 4.5.4

4.6 Root graphs of DHL graphs

A graph G is **distance-hereditary** if for any induced subgraph H , $d_H(u, v) = d_G(u, v)$, for any $u, v \in V(H)$. A detailed study can be seen in [8]. A graph G is **chordal** if every cycle of length at least four in G has an edge(chord) joining two non-adjacent vertices of the cycle [6]. A graph is **Ptolemaic** if it is both

distance-hereditary and chordal [23].

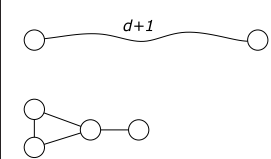
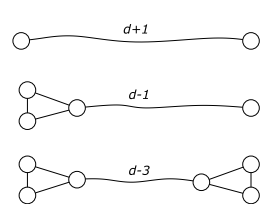
In this section, the family of root graphs of distance-hereditary line (DHL) graphs is obtained. The root graphs of chordal and Ptolemaic graphs are also discussed.

Theorem 4.6.1. [8] *Let G be a connected graph. Then G is distance-hereditary if and only if the graphs of Fig 4.4 and the cycles C_n with $n \geq 5$ are forbidden subgraphs of G .*

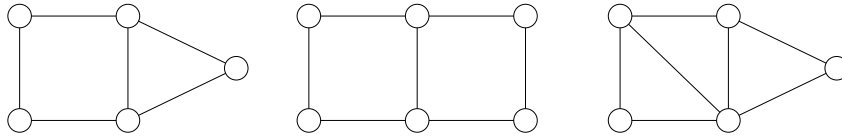

Figure 4.4: The graphs for Theorem 4.6.1: house, domino and gem graphs.

Theorem 4.6.2. [23] *Let G be a graph. The following conditions are equivalent*

1. G is Ptolemaic.
2. G is distance-hereditary and chordal.
3. G is chordal and does not contain an induced gem.

A vertex v is simplicial if $N(v)$ is a clique. The ordering $\{v_1, \dots, v_n\}$ of the vertices of H is a perfect elimination ordering if, for all $i \in \{1, \dots, n\}$, the vertex v_i is simplicial in $H_i = \langle v_i, \dots, v_n \rangle$.

Theorem 4.6.3. [16] *Let G be a graph. The following statements are equivalent:*

1. G is a chordal graph.
2. G has a perfect elimination ordering. Moreover, any simplicial vertex can start a perfect elimination ordering.

Theorem 4.6.4. *In a DHL graph if a vertex is adjacent to at least one vertex in a C_4 then it must be adjacent to all the vertices of that C_4 and to no other vertices in the graph.*

Proof. Let H be a DHL graph which contains a C_4 and let a vertex u be adjacent to at least one vertex of the C_4 . If u is adjacent to exactly one vertex of C_4 then a $K_{1,3}$ is formed in H , which is a contradiction. Let u be adjacent to exactly two vertices of C_4 . Then either a house, when u is adjacent to two adjacent vertices of C_4 , or a $K_{1,3}$, when u is adjacent to two non-adjacent vertices of C_4 is formed, which is also a contradiction. Since an F_2 is obtained when u is adjacent to three vertices of a C_4 , u must be adjacent to all the four vertices of the C_4 . \square

Next we show that two adjacent vertices can not be made adjacent to a C_4 in H . For, otherwise each of the two vertices must be adjacent to all the vertices of C_4 and hence induces $C_4 \vee K_2$. But a copy of F_3 is induced in $C_4 \vee K_2$, which is a contradiction. If only one vertex of two adjacent vertices is adjacent to C_4 , a $K_{1,3}$ is induced in H which is also a contradiction.

Corollary 4.6.5. *A DHL graph contains at most one C_4 .*

Corollary 4.6.6. *The root graphs of DHL graphs which contain a C_4 are K_4 , $K_4 - e$ and C_4 .*

Proof. The proof is complete as we see from Corollary 4.6.5 that the only DHL graphs which contain a C_4 are $C_4 \vee 2K_1$, $C_4 \vee K_1$ and itself. \square

As there are only three DHL graphs containing a C_4 , we restrict our discussion in the following sections to DHL graphs not containing C_4 's.

If H is a DHL graph containing no anti-Gallai triangle then its root graph contains no triangles. Also, a DHL graph is C_n -free, $n \geq 5$. Now, together with Corollary 4.6.6, we have the following result.

Theorem 4.6.7. *Let $H \not\cong C_4$ be a DHL graph not containing an anti-Gallai triangle, then H is a line graph of a tree.*

Lemma 4.6.8. *An anti-Gallai triangle in a DHL graph has a vertex of degree two.*

Proof. Let uvx be an anti-Gallai triangle in a DHL graph $H \not\cong K_3$. Then uvx is in some $K_4 - e$ in H . Let uvy be a triangle such that $u, x, y, w \cong K_4 - e$. We now show that degree of the vertex x is two. Consider h_x , we just need to show that L_1 contains no vertices other than u and v . For, let w be a vertex in L_1 . Then

wx is an edge and, by Theorem 4.2.4, either u or v is adjacent to w . Then y cannot be adjacent to w as $N(w) \cap \{u, v, x, y\}$ together with w induce $C_4 \vee K_1$. But, $\langle u, v, w, x, y \rangle$ is a gem, a contradiction. \square

By Lemma 4.6.8, it now follows that each triangle in the root graph of a DHL graph is attached to the graph by sharing at the most one vertex. Let \mathcal{T} be the family of trees. Let \mathcal{T}_Δ be the family of graphs obtained by attaching some triangles to some vertices in a tree T , for each $T \in \mathcal{T}$.

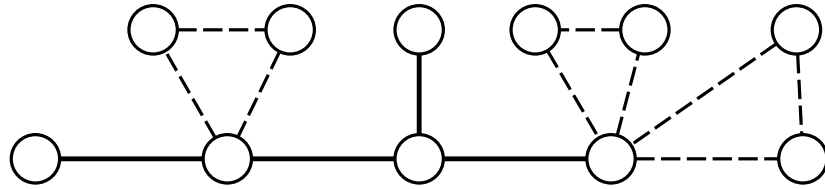

Figure 4.5: A graph $G \in \mathcal{T}_\Delta$.

Theorem 4.6.9. *A graph G is a root graph of a C_4 -free DHL graph if and only if $G \in \mathcal{T}_\Delta$.*

Proof. The proof is by induction on the number of edges in a $T \in \mathcal{T}_\Delta$. It can be verified that the root graphs of distance-hereditary graphs of size ≤ 3 are in \mathcal{T}_Δ and hence the theorem is true for all $m \leq 3$.

Let $T \in \mathcal{T}_\Delta$ has m edges and T is a root graph of a DHL

graph. Let T' be a graph in \mathcal{T}_Δ with $E(T') = E(T) \cup \{e\}$. Since T' must be connected, there can be two cases: either (i) the edge e is added as a pendent edge to T or (ii) the edge e is formed by joining two vertices in T .

Let l_e be the vertex in $L(T')$ corresponding to the edge e in T' . In case(i), since e is a pendant edge in T' , l_e is simplicial in $L(T')$. We can now show that $L(T')$ is gem-free. If possible let a gem is there in $L(T')$. Since $L(T)$ is distance-hereditary and C_4 -free, it is chordal. By Theorem 4.6.2 $L(T)$ is gem-free, l_e must be a vertex in the induced gem. But, $N(l_e)$ is complete so that l_e is one of the degree two vertices in the gem. Now l_e is in a $K_4 - e$. By Lemma 4.6.8, one of the two triangles in the $K_4 - e$ must be an anti-Gallai triangle. But the triangle containing l_e cannot be so, as e is a pendant edge in T' . But the other triangle has no vertex of degree 2 in the induced gem. This is a contradiction, by Lemma 4.6.8, to the assumption that $L(T')$ contains a gem.

In case(ii), as T is connected, adding an edge e joining two vertices of T makes a cycle in T' . But $T \in \mathcal{T}_\Delta$ is C_n -free, $n \geq 4$, and contains no $K_4 - e$. Hence e joins two pendant vertices of T , forming a triangle and has end vertices of degree two. Therefore in $L(T')$, the corresponding vertex l_e is in an anti-Gallai triangle

and has degree two. It now follows that l_e is simplicial. If $L(T')$ contains a gem, l_e must be one of the degree two vertices in the induced gem. But in this case the anti-Gallai triangle containing l_e does not satisfy Theorem 4.2.4 with the other vertex of degree two in the induced gem, which is again a contradiction.

In both the cases we have now a one-vertex extension $L(T')$ of a gem-free chordal graph $L(T)$ and hence $L(T')$ is a DHL graph.

Conversely, let $L(G) \cong H$ be a C_4 -free DHL graph. We need to prove that $G \in \mathcal{T}_\Delta$. It is clear that G is $\{K_4, K_4 - e, C_4\}$ -free, otherwise H would contain a C_4 . Since H is C_n -free, for $n \geq 4$, it follows that G is $\{K_4 - e, K_n, C_n\}$ -free, for $n \geq 4$. Now, triangles are the only possible cycles in H and G . Thus, if H does not contain an anti-Gallai triangle, then G is a tree. If H contains an anti-Gallai triangle, then by Lemma 4.6.8, the corresponding triangle in G must have at least two vertices of degree 2. Hence the proof. \square

Corollary 4.6.10. *A graph $L(G)$ is Ptolemaic if and only if $G \in \mathcal{T}_\Delta$.*

Corollary 4.6.11. *Let \mathcal{T}_Δ^c be the family of graphs obtained by attaching some triangles to some vertices in a tree T and identifying each edge of T by an edge of at most one triangle, for each $T \in \mathcal{T}$. Then $L(G)$ is a chordal graph if and only if $G \in \mathcal{T}_\Delta^c$.*

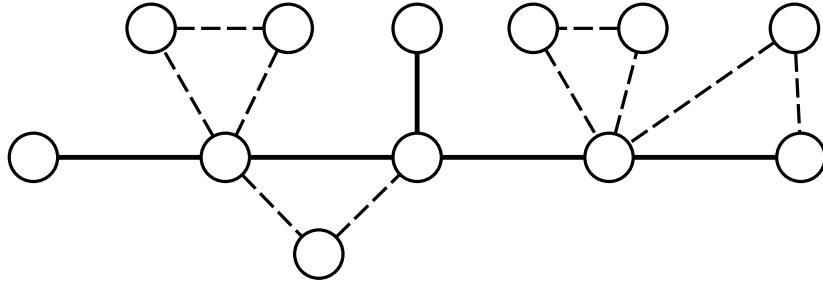

Figure 4.6: A $\{C_4, K_4, K_4 - e\}$ -free graph G . Clearly $G \in \mathcal{T}_\Delta^c$.

Chapter 5

Root graphs of anti-Gallai graphs

In this chapter we find a structural relation among the triangles of an anti-Gallai graph. Using this, we find the root graphs of anti-Gallai graphs, which are triangle-irreducible.

5.1 Basic definitions

The following definitions are exclusively for this chapter.

Definition 5.1.1. Let $G = (V, E)$ be a graph. For a vertex $u \in V$, $N(u)$ denotes the set of all neighbors of u and $N_M(u) = N(u) \cap M$, where $M \subseteq V$. Define $N(u_1 u_2 \dots u_k) = \cup_{i=1}^k N(u_i)$, $N^*(u_1 u_2 \dots u_k) = \cap_{i=1}^k N(u_i)$ and $N'(uvw) = N^*(uv) \cup N^*(vw) \cup N^*(uw) \setminus N^*(uvw) \setminus \{u, v, w\}$.

Definition 5.1.2. The **corona** $G_1 \odot G_2$ of graphs G_1 and G_2 is the graph obtained by taking one copy of G_1 , which has n_1 vertices, and n_1 copies of G_2 , and then joining the i th vertex of G_1 by an edge to every vertex in the i th copy of G_2 .

Definition 5.1.3. A graph G is **triangle-reducible** if there is a partition $E(G) = \cup_i E_i$ such that for any triangle uvw in G , the edges $uv, uw, vw \in E_i$, for some i . G is **triangle-irreducible** if G is not triangle-reducible. A subgraph J is maximal triangle-irreducible (MTI) if there are no triangle-irreducible graphs containing J as a proper subgraph.

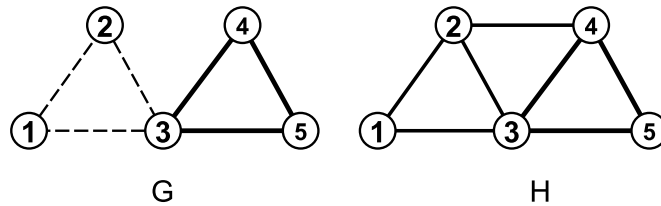

Figure 5.1: A triangle reducible graph G and a triangle irreducible graph H .

5.2 Anti-Gallai triangles in an anti-Gallai graph

From this section we consider the graph H as the anti-Gallai graph of a graph G . Let uvw be a triangle in H and \bar{u}, \bar{v} and \bar{w} be the edges in G representing the vertices u, v and w respectively in H . If the edges \bar{u}, \bar{v} and \bar{w} induces a triangle in G then the triangle uvw in H is referred to as an anti-Gallai triangle or

a type I triangle. A triangle in H which is not of type I is type II.

Remark 5.2.1. Any edge of a type II triangle belongs to some type I triangle. Since any two edges of a triangle uniquely determines the third edge, any edge uv in a triangle of H has exactly one vertex w such that uvw is a type I triangle. Also, $N^*(uvw) = \emptyset$ for any type I triangle in H .

Remark 5.2.2. When uvw is a type II triangle in H , the edges \bar{u}, \bar{v} and \bar{w} cannot induce a triangle in G . But any pair of these edges must belong to a triangle, hence the edges \bar{u}, \bar{v} and \bar{w} have a common end point. Choosing \bar{x}, \bar{y} and \bar{z} as the edges uniquely determined by these pairs, we get $\langle \bar{x}\bar{y}\bar{z}\bar{u}\bar{v}\bar{w} \rangle \cong K_4$.

Lemma 5.2.3. *If uvw is a type II triangle then there exist a unique type I triangle which is induced in $\langle N'(uvw) \rangle$.*

Proof. From remark 5.2.2, the edges \bar{u}, \bar{v} and \bar{w} in G uniquely determine the edges \bar{x}, \bar{y} and \bar{z} and hence x, y and $z \in N'(uvw)$. Also, since \bar{x}, \bar{y} and \bar{z} induces a triangle, xyz is a type I triangle induced in $\langle N'(uvw) \rangle$.

In order to complete the proof we need to show that any induced triangle in $\langle N'(uvw) \rangle$ is type II. Let pqr be a triangle induced in $\langle N'(uvw) \rangle$. By the uniqueness of \bar{x}, \bar{y} and \bar{z} , the edges \bar{p}, \bar{q} and \bar{r} have a common end point same as that of \bar{u}, \bar{v} and \bar{w} . So $\langle \bar{p}\bar{q}\bar{r} \rangle$ cannot induce a triangle in G and Hence

pqr is a type II triangle in H . □

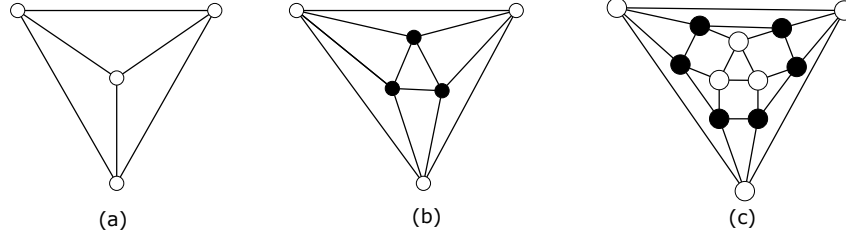

Figure 5.2: Graphs K_4 , $\text{antigal}(K_4)$ and $\text{antigal}^2(K_4)$.

Lemma 5.2.4. *If uvw is a type I triangle in H then $\langle N'(uvw) \rangle$ is a disjoint union of type II triangles of H .*

Proof. Assume that there is a vertex x in $N'(uvw)$ adjacent to u and v . Since $x \neq w$, there are two triangles $\bar{x}\bar{u}\bar{y}$ and $\bar{x}\bar{v}\bar{z}$, uniquely determined, with $\bar{y} \neq \bar{z}$.

Here $\langle \bar{u}, \bar{v}, \bar{w}, \bar{x}, \bar{y}, \bar{z} \rangle \cong K_4$ and also $y \in N^*(uw)$ and $z \in N^*(vw)$, both nonadjacent to v and u respectively. Hence y and z are in $N'(uvw)$ and the triangle xyz is a type II triangle in H .

Let x_1, x_2, \dots, x_k be the vertices in $N'(uvw)$ which are not adjacent to w in H . For each x_i there exist unique vertices $y_i \in N^*(uw)$ and $z_i \in N^*(vw)$ such that $\langle x_i, y_i, z_i \rangle$ is a type II triangle. In order to complete the proof, we now need to show that $y_i \neq z_j$, whenever $i \neq j$. Assuming the contrary, let $y_i = z_j = p$

for some $i \neq j$. Then $p \in N^*(uw) \cap N^*(vw) \cap N^*(uw)$, or $p \in N^*(uvw)$. But, $N^*(uvw) = \emptyset$ for a type I triangle, this is a contradiction. \square

From the previous lemma the number of common neighbors of any edge in a type I triangle uvw is the same, and is equal to the number of type II triangles in $N'(uvw)$.

5.3 Relations between triangles

Definition 5.3.1. Two triangles $\Delta t_1 = uvw$ and $\Delta t_2 = xyz$ in H are in relation \mathcal{R} , denoted by $\Delta t_1 \mathcal{R} \Delta t_2$, if $\Delta t_1 \in N'(\Delta t_2)$ and vice versa.

Notation: We write $uvw \mathcal{R} xyz$ if $z \in N^*(uw)$, $y \in N^*(uw)$ and $x \in N^*(vw)$.

Remark 5.3.2. It can be seen from Figure 5.2(b) that the triangle with black colored vertices and the triangle with white colored vertices are in relation \mathcal{R} , precisely which we mean by the Definition 5.3.1 of \mathcal{R} . Thus $antigal^2(K_4)$, in Figure 5.2(c), can also be viewed as the anti-Gallai graph of two triangles in relation \mathcal{R} .

Lemma 5.3.3. *If $uvw \mathcal{R} xyz$ then $uyz \mathcal{R} xvw$, $vxz \mathcal{R} yuw$ and $wyx \mathcal{R} zvu$. Moreover if uvw is a type I triangle then the first one in each pair is type I triangle and the other is type II.*

Lemma 5.3.4. *If two type II triangles $uvw \mathcal{R} xyz$ in H then the edges in G corresponding to these vertices have a vertex in common.*

Proof. In G , let v_1 be the vertex in common for the edges \bar{u}, \bar{v} and \bar{w} and let v_2 be that for the edges \bar{x}, \bar{y} and \bar{z} . If v_1 and v_2 are different, then at least one of the edges of \bar{u}, \bar{v} and \bar{w} can be made non-adjacent with at least two edges of \bar{x}, \bar{y} and \bar{z} . Without lose of generality let \bar{u} be such an edge. That is \bar{u} is adjacent to at most one of the edges in \bar{x}, \bar{y} and \bar{z} . Then in H , $u \notin N'(x, y, z)$, which is a contradiction. \square

Theorem 5.3.5. *If Δt and Δs are two type II triangles in H and $\Delta t \mathcal{R} \Delta s$, then there exist type I triangles Δp and Δq and a C_6 in H such that $\Delta t \mathcal{R} \Delta p$, $\Delta s \mathcal{R} \Delta q$ and $\langle \Delta p, \Delta q, C_6 \rangle_H \cong \text{antiGal}^2(K_4)$.*

Proof. Let $\Delta t = t_1 t_2 t_3$ and $\Delta s = s_a s_b s_c$ be two type II triangles such that $t_1 t_2 t_3 \mathcal{R} s_a s_b s_c$. By Lemma 5.2.3, there are type I triangles $\Delta p = p_1 p_2 p_3$ and $\Delta q = q_a q_b q_c$ such that $\Delta t \mathcal{R} \Delta p$ and $\Delta s \mathcal{R} \Delta q$.

In H , $t_1 \in N^*(s_b s_c)$. Then, in G , there are edges \bar{u}_{1b} and \bar{u}_{1c} such that $\langle \bar{t}_1 \bar{u}_{1b} \bar{s}_b \rangle$ and $\langle \bar{t}_1 \bar{u}_{1c} \bar{s}_c \rangle$ are triangles. Now, using a set of similar arguments, there are vertices $u_{1b}, u_{1c}, u_{2a}, u_{2c}, u_{3a}$ and u_{3b} in H . We can see that u_{ij} and u_{kl} are adjacent if and

only if either $i = k$ or $j = l$. Hence these six vertices induce a C_6 in H . Also, $\bar{\Delta}p\mathcal{R}\bar{\Delta}q$ in G . Then by Remark 5.3.2, we have $\langle \Delta p, \Delta q, C_6 \rangle \cong \text{antigal}^2(K_4)$. \square

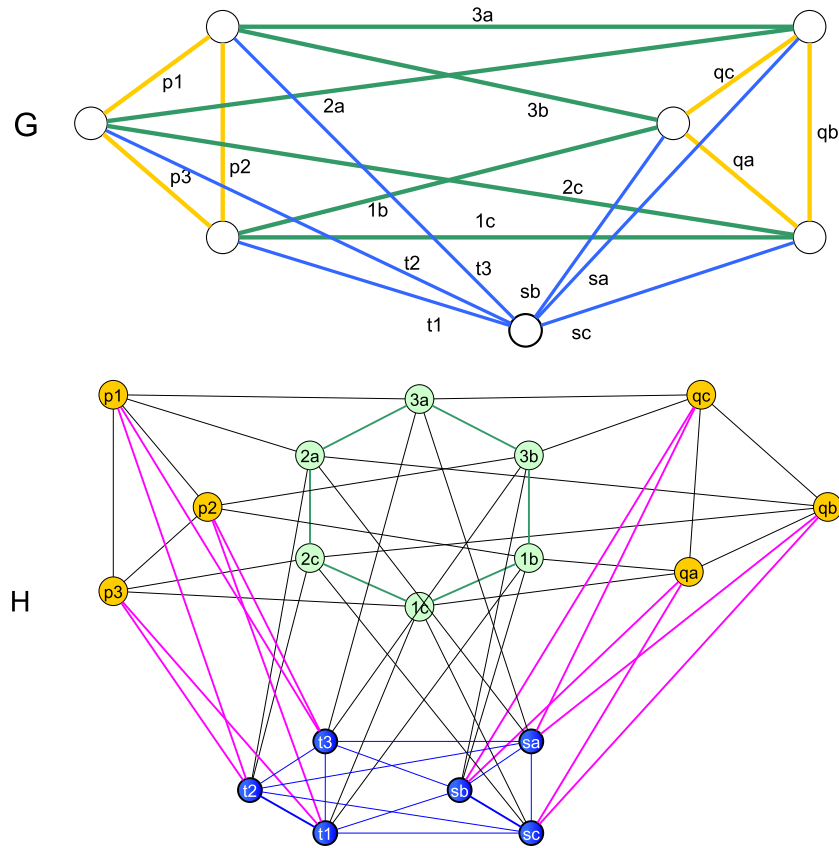

Figure 5.3: Illustration of Theorem 5.3.5. Here $H \cong \text{antigal}(G)$, $\Delta t = t_1 t_2 t_3$ and $\Delta s = s_a s_b s_c$ are type II and $\Delta t \mathcal{R} \Delta s$.

The **base graph** B_H of anti-Gallai graph H is a graph with vertex set as the set of triangles in H . Two vertices t and s in

B_H are adjacent if $\Delta t \mathcal{R} \Delta s$ in H . A vertex t in B_H is type I, if Δt is a type I triangle in H and t is type II otherwise. A cycle C_6 in B_H is denoted by C_6^* if it contains at least one type I vertex.

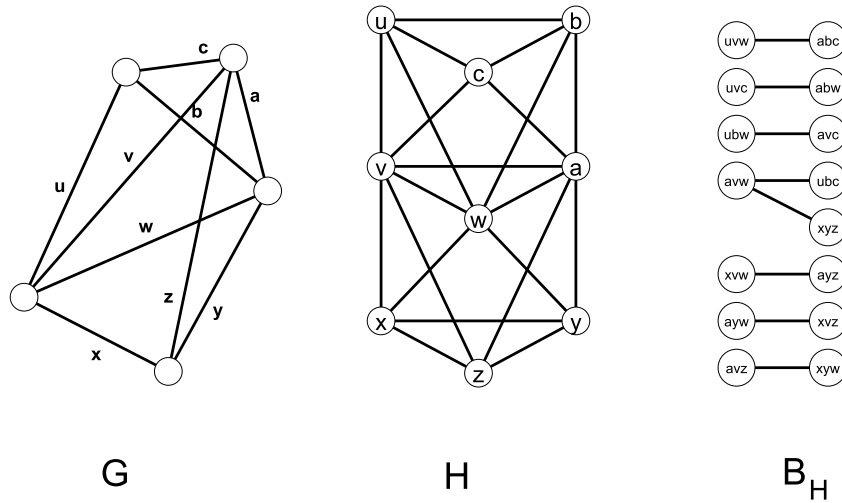

Figure 5.4: A graph G , $H \cong antiGal(G)$ and B_H .

Lemma 5.3.6. *In B_H , we have*

1. *If a C_n contains a type I vertex, then there are at least two type I vertices and $n \geq 6$.*
2. *All the vertices in a cycle C_n of length $n < 6$ are type II.*
3. *In a C_6^* , exactly two vertices are type I.*
4. *Any vertex adjacent to C_6^* is type II.*

5. In a component $K_{1,n}$, $n > 1$, all the pendant vertices are type II and the central vertex is type I.
6. Any subgraph B_1 of B_H , with $V(B_1)$ are all type II, is an induced subgraph of $B_1 \odot K_1$.

Proof. (1) Let $C = t_1, t_2, \dots, t_n$ be a cycle of length n . Assume that t_1 is a type I vertex. If all the vertices t_i , $1 < i \leq n$ are type II, by Lemma 5.3.4, they should share a common vertex. Since $t_2, t_n \in N(t_1)$, by Lemma 5.2.4, t_2 and t_n are type II triangles and they do not share a common vertex in H , which is a contradiction. Hence there are at least two type I vertices in C . Let t_j , $j \neq 1$ be another type I vertex in C . By Lemma 5.2.3, t_j is neither adjacent with t_2 nor with t_n and hence $n \geq 6$. The proof of (2) and (3) follows from (1).

(4) Let t be a vertex adjacent a vertex s in C_6^* . If s is type I, then by lemma 5.2.4 t is type II. If s is type II, then the unique type I vertex adjacent to s is also in C_6^* , hence t is type II again.

(5) The proof follows from Lemma 5.2.4.

(6) Since any vertex of B_1 corresponds to a type II triangle in H , for each $t_i \in V(B_1)$, $i \in I$, by Lemma 5.2.3, there are unique type I triangles Δs_i , such that $\Delta t_i \mathcal{R} \Delta s_i, \forall i$. It is then clear that the resulting induced graph in B_H is $B_1 \odot K_1$.

□

Thus it follows that identifying a type I vertex, in a C_6^* , im-

plies that the types of all the vertices in that C_6^* can be identified. Also, if a cycle is a C_6^* then $\langle t_i, t_j, C \rangle_H \cong \text{antiGal}^2(K_4)$, where $t_i, t_j \in V(C_6)$ with $d_{C_6}(t_i, t_j) = 3$ and C is a cycle of length six in H .

Observation 5.3.7. *If $u, v \in V(H)$ are such that \bar{u} and \bar{v} are independent in G , then corresponding to any vertex $w \in N^*(u, v)$, the edge \bar{w} in G is adjacent to both \bar{u} and \bar{v} and hence $|N^*(u, v)| \leq 4$.*

We now discuss a part of the converse of Theorem 5.3.5.

Theorem 5.3.8. *If $t_1 t_2 t_3 t_4$ is a path in B_H , neither induced in a C_6^* nor in a $P_4 \odot K_1$, with $\langle \Delta t_1, \Delta t_4, C_6 \rangle_H \cong \text{antiGal}^2(K_4)$, for some C_6 in H , then Δt_2 and Δt_3 are type II triangles in H and $\Delta t_1, \Delta t_4$ are the unique type I triangles of $\Delta t_2, \Delta t_3$, respectively.*

Proof. Assume the conditions in the assertion. If Δt_2 and Δt_3 are not type II triangles, they must be triangles of different types. Assume without loss of generality that Δt_2 is type I and Δt_3 is type II. Then Δt_1 and Δt_4 are type II triangles. Let u_1 be a vertex common to the edges in $\bar{\Delta t}_1$ in G . Also, by Lemma 5.3.4, there is a vertex u_2 in G common to the edges in $\bar{\Delta t}_3$ and $\bar{\Delta t}_4$. By Theorem 5.3.5, there is a type I triangle Δt_5 with $\Delta t_4 \mathcal{R} \Delta t_5$ in H and $\bar{\Delta t}_2 \mathcal{R} \bar{\Delta t}_5$ in G .

Now consider the vertices c_i in C_6 , where $\langle \Delta t_1, \Delta t_4, C_6 \rangle_H \cong \text{antiGal}^2(K_4)$. We have the edges in $\bar{\Delta}t_1$ and $\bar{\Delta}t_2$ are independent and hence \bar{c}_i must be the edges adjacent to both $\bar{\Delta}t_1$ and $\bar{\Delta}t_2$. Now, the only edges possible, denoted by \bar{w}_i , which are adjacent to both $\bar{\Delta}t_1$ and $\bar{\Delta}t_2$ are from u_1 to both the ends of the edges in $\bar{\Delta}t_4$. It can be seen that $\{\bar{w}_i\}_i \setminus \{u_1 u_2\}$ forms the edges of a type II triangle Δt_6 in H such that $\Delta t_6 \mathcal{R} \Delta t_1$ and $\Delta t_6 \mathcal{R} \Delta t_5$. But it then turns out that $\langle t_1, \dots, t_6 \rangle_{B_H} \cong C_6^*$, which is a contradiction. Hence Δt_2 and Δt_3 are of type II.

We now show that Δt_1 and Δt_4 are the unique type I triangles of Δt_2 and Δt_3 respectively. If all the vertices in the path $t_1 t_2 t_3 t_4$ are type II, then, by (6) of Lemma 5.3.6, $t_1 t_2 t_3 t_4$ is induced in an $P_4 \odot K_1$, which is a contradiction and hence at least one of the triangles Δt_1 and Δt_4 is type I. If they are of different types, then assume without loss of generality that Δt_1 is type I and Δt_4 is type II. Now $\Delta t_1 \mathcal{R} \Delta t_2$ and Lemma 5.2.3 imply that Δt_1 is the unique type I triangle of Δt_2 .

Let $\Delta t_1 = x_1 x_2 x_3$, $\Delta t_2 = y_4 y_5 y_6$ and $\Delta t_4 = z_7 z_8 z_9$. Since Δt_2 is type II, there is a vertex u common to the edges \bar{y}_4, \bar{y}_5 and \bar{y}_6 in G . Since $\Delta t_2 \mathcal{R} \Delta t_3 \mathcal{R} \Delta t_4$, by Lemma 5.3.4, u is also common to the edges \bar{z}_7, \bar{z}_8 and \bar{z}_9 .

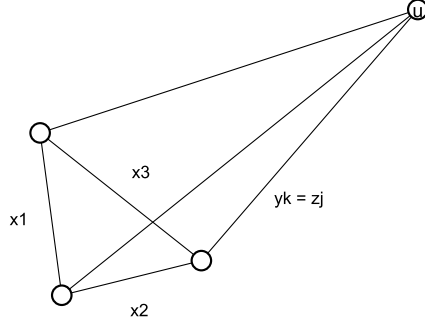

Figure 5.5: When an edge y_k coincide with an edge z_j .

We claim that the vertices in Δt_1 and Δt_4 are different. For otherwise, assume that some vertices of these triangles coincide. But, in G , this would imply that u is an end vertex of \bar{x}_i , for some i , which is a contradiction to the definition of u . Also, the edges $\{\bar{x}_i\}_i, \forall i$ and the edges $\{z_j\}_j, \forall j$ are independent. For other wise, assume that, an edge \bar{x}_i is adjacent to an edge \bar{z}_j for some i and j . It then becomes that the edge \bar{z}_j should coincide with an edge y_k for some k . But if $\bar{z}_j, \forall j$ and $\bar{y}_k, \forall k$ are coincided, then Δt_2 and Δt_4 are the same in H , which contradicts $t_1 t_2 t_3 t_4$ to be a path. Thus there is at least one non-adjacent pair (\bar{z}_j, \bar{y}_k) , for some i and k , (see Figure 5.5). In this case we can see that $\langle x_1, x_2, x_3, z_j \rangle_H \cong K_4 - e$. But this is a contradiction to $\langle \Delta t_1, \Delta t_4, C_6 \rangle_H \cong antiGal^2(K_4)$, as $K_4 - e$ is not an induced subgraph of $antiGal^2(K_4)$. Thus \bar{x}_i is non-adjacent to $\bar{z}_j, \forall i, j$.

Consider the C_6 in H such that $\langle \Delta t_1, \Delta t_4, C_6 \rangle_H \cong \text{antiGal}^2(K_4)$. Since the edges corresponding Δt_1 and Δt_4 are independent in G , each edge \bar{v} corresponding to a vertex in C_6 must be adjacent to an edge in each of the sets $\{\bar{x}_i\}_i$ and $\{\bar{y}_j\}_j$. Let $ab \in E(C_6)$ in H . Then there is a triangle $\langle \bar{a}\bar{b}\bar{x} \rangle$ in G , for some $x \in V(H)$. Let w be a vertex common to the edges \bar{a} and \bar{b} in G . Then, we have the following cases(See Figure 5.6).

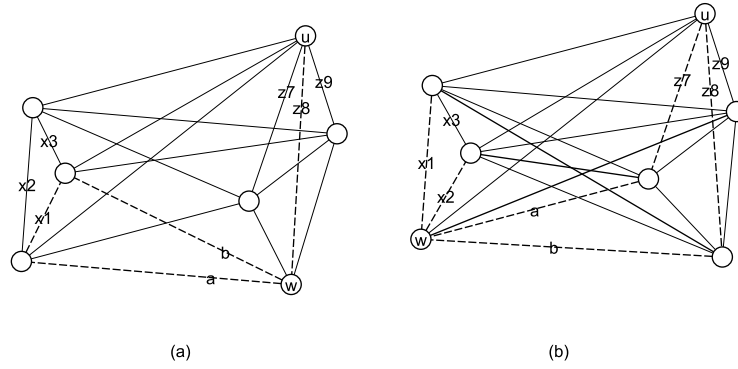

Figure 5.6: Proof of Theorem 5.3.8. Case 1 and 2.

Case 1. w is a common vertex to \bar{a}, \bar{b} and \bar{z}_j . Then, there is at most one edge \bar{z}_j that has w as the end vertex. Without loss of generality, let $j = 8$. But, then $\langle x_1, a, b, z_8 \rangle \cong K_4 - e$, which is a contradiction.

Case 2. w is a common vertex to \bar{a}, \bar{b} and \bar{x}_i . Then, there is exactly two edges in $\{\bar{x}_i\}_i$ has w as the end vertex. Without loss

of generality assume the adjacency to be as in the Figure 5.6(b). Here when all the dotted lines are absent, $\langle x_1, x_2, a, b, z_7, z_8 \rangle$ is isomorphic to a domino, which is a contradiction. When some or all the dotted edges are present, $\langle a, b, x_1, x_2 \rangle$ would be a $K_4 - e$ or K_4 respectively, each of which is a contradiction as all such graphs are forbidden in an $antiGal^2(K_4)$. Thus all the possible cases when Δt_4 to be type II is contradicted. Hence Δt_4 is type I, and it is unique as per Lemma 5.2.3.

□

We now combine Theorem 5.3.5 and Theorem 5.3.8.

Theorem 5.3.9. *If $t_1 t_2 t_3 t_4$ is a path in B_H , neither induced in a C_6^* nor in a $P_4 \odot K_1$, then t_1, t_4 are type I and t_2, t_3 are type II if and only if there is a C_6 in H such that $\langle \Delta t_1, \Delta t_4, C_6 \rangle_H \cong antiGal^2(K_4)$.*

We see that, in the above theorem, when $\langle t_1, \dots, t_6 \rangle_{B_H} \cong C_6^*$, the subgraph $\langle \bar{t}_1, \dots, \bar{t}_6 \rangle_G \cong antiGal(K_4) \vee 2K_1$. When $B_H \cong K_2$, its end vertices can be type I or type II. Also, it is possible to relabel the edges of $antiGal(K_4) \vee 2K_1$ such that the types of vertices in a C_6^* are different in B_H , as given in Figure 5.7.

Lemma 5.3.10. *If an edge, which is not in a C_6^* , is adjacent to a C_6^* , then all the vertices in that C_6^* can be identified.*

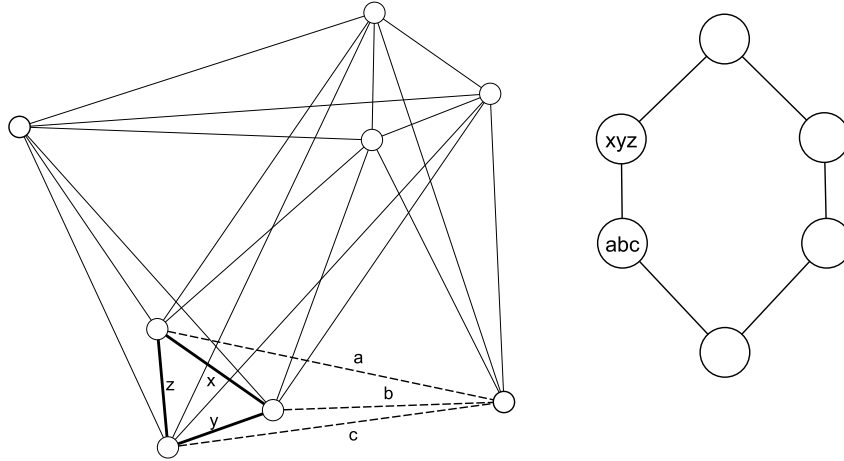

Figure 5.7: A relabelling obtained by interchanging the labels of the thick and dotted edges give the same C_6^* in B_H .

Proof. Let t be a vertex in a C_6^* and ts be an edge not in any C_6^* . Now, by Lemma 5.3.6, s is type II. Since s has exactly one type I vertex as neighbor, if $\deg(s) = 1$ then t is type I and we are done. So let $\deg(s) > 1$. Also, let t_1 and t_2 are the vertices adjacent to t in the same C_6^* . Now, there are two cases as follows.

When t is type II, either t_1 or t_2 is type I. Since s is also type II, there must be a type I neighbor r of s such that $t_i t s r$ is a sequence of $I - II - II - I$ for $i = 1$ or 2 and hence satisfying $\langle t_i, r \rangle \cong \text{antigal}^2(K_4)$.

When t is type I, both t_1 and t_2 are type II and any vertex r in $N(s) - \{t\}$ is also type II. Hence $t_i t s r$ is a sequence $II - I - II - II$

and do not satisfy $\langle t_i, r \rangle \cong \text{antigal}^2(K4)$, for any i , since ts is not an edge in any C_6^* . Thus the case of t being type I can be distinguished and hence the proof. \square

Let \mathcal{F} be the family of graphs with each edge is in some C_6^* . For $n \geq 1$, let H_{4n+4}^C be a graph defined by taking two copies of C_{4n+4} , that is, $x_1 \dots x_{4n+4}$ and $y_1 \dots y_{4n+4}$ and making the adjacencies $\{x_i y_i / i \equiv 1 \pmod{2}\}$. Also, define H_{2n+1}^P by taking two copies of P_{2n+1} , that is, $x_1 \dots x_{2n+1}$ and $y_1 \dots y_{2n+1}$ and making the adjacencies $\{x_i y_i / i \equiv 1 \pmod{2}\}$. If each C_6 in these graphs are a C_6^* , the graphs are denoted by $H_{4n+4}^{C^*}$ and $H_{2n+1}^{P^*}$. It can be seen that $H_3^{P^*} \cong C_6^*$.

It is not difficult to see that \mathcal{F} can be obtained by including all $H_{4n+4}^{C^*}$, $H_{2n+1}^{P^*}$ and the graphs obtained by identifying any two edges of the form $x_i y_i$, when i is odd.

Theorem 5.3.11. *When a component of B_H is $H_{4n+4}^{C^*}$, there are exactly two labelling for the edges in G corresponding to $H_{4n+4}^{C^*}$ in B_H .*

Proof. Let G be a graph such that a connected component of B_H be $H_{4n+4}^{C^*}$, for some n . From Lemma 5.3.6, it follows that x_i, y_i , for $i \equiv 0 \pmod{4}$ are type II. If x_i is type I (type II) for some i , then the only remaining type I (type II) triangles are x_p , $p \equiv i \pmod{4}$ and y_q , $q \equiv i + 1 \pmod{4}$ and all the remaining triangles are type II (type I). Since x_i is type I or type II in a

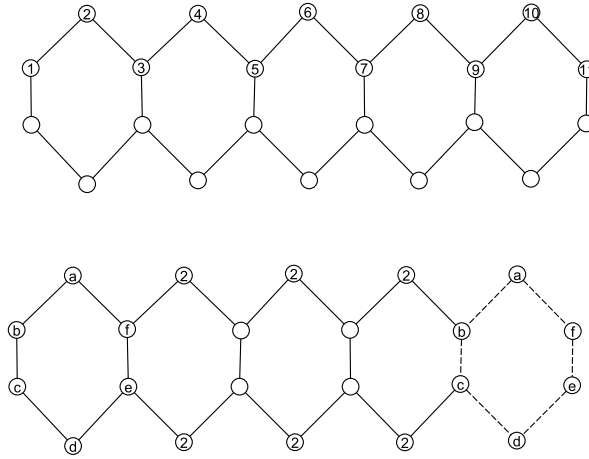

Figure 5.8: On top: a graph H_{11}^{P*} with one copy of P_{11} is labelled. On bottom: a graph H_8^{C*} . In this the right most C_6^* , with dotted lines, coincide with left most C_6^* , thus making a cycle of C_6^* 's.

labelling, there are exactly two possible labelling in G . □

Corollary 5.3.12. *For any graph in \mathcal{F} , there are at least two labellings possible in its corresponding graph G .*

Theorem 5.3.13. *If $F \not\cong K_2$ and $F \notin \mathcal{F}$, then all the vertices in any component F in B_H can be identified as type I or type II.*

Proof. Consider $F \not\cong K_2$ and $F \notin \mathcal{F}$. If F does not contain a C_6^* then it can be identified by Theorem 5.3.8. So let P be a C_6^* in F . If an edge adjacent to P is not in a C_6^* , it can be identified by Lemma 5.3.10. So let all the edges adjacent to P is in some C_6 . Let F' be a maximal graph containing P which is in \mathcal{F} .

Case A: P is the only C_6^* in F' .

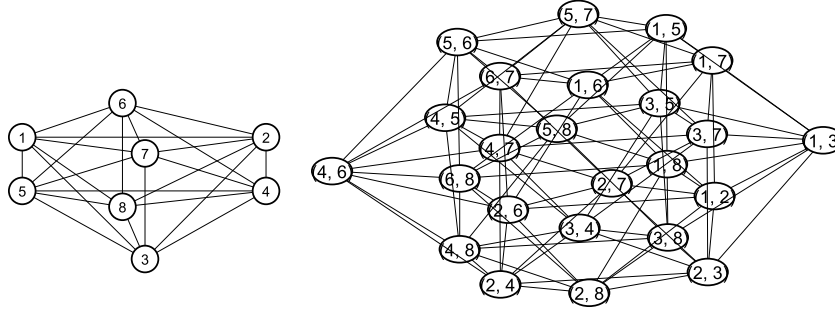

Figure 5.9: A graph G and $H \cong \text{antiGal}(G)$. Here B_H is a graph with 96 vertices containing 16 components of C_6^* 's.

If there are no C_6^* are adjacent to P then there is nothing to be proved. Let Q be another C_6^* adjacent to P .

Case A – I: P and Q share vertices but no edges.

Case A – I(1): P and Q share exactly one vertex.

Let u be the vertex in common to P and Q . By Lemma 5.3.6, $N(u)$ in P and Q are type II. Now, u is type I and hence all the vertices in P and Q are identified.

Case A – I(2): P and Q share more than one vertex.

Note that P and Q can not share two consecutive vertices of either as this would lead to the case of sharing an edge between these two. So, let non-consecutive vertices of Q be shared with P . But it can be seen that each vertex of Q is in some cycle of length less than 6. Now by Lemma 5.3.6, all the

vertices are type II. But this contradicts Q being a C_6^* . Hence no such component is possible in B_H .

Case A – II: P and Q share edges.

Case A – II(1): P and Q share exactly one edge.

Since $F' \cong C_6^*$, F' together with Q is again a graph in \mathcal{F} , which contradicts the maximality of F' and thus this case is not possible.

Case A – II(2): P and Q share more than one edge.

It can be seen that when P and Q share non-consecutive edges, any vertex in P or Q is in some cycle of length less than 6, which is a contradiction as in Case I(2). When P and Q share consecutive 4 or 5 edges, such graphs do not exist as, with Lemma 5.3.6, it will contradict P or Q being a C_6^* . Now, when 2 or 3 consecutive edges are shared, the vertices of P and Q can be uniquely labelled using Lemma 5.3.6.

Case B: F' contain more than one C_6^* .

Again let P be a C_6^* in F' and Q be another C_6^* , which is not in F' , adjacent to P .

Case B – (I): F' and Q share vertices but no edges.

If Q share exactly one vertex with F' , that is with any of the C_6^* in F' , then the vertices can be identified as in Case AI(1). Similarly the case of sharing of more than

one non-consecutive vertices is same as Case $A-(I)(2)$.

Case $B-(II)$: F' and Q share edges.

Case $B-(II)(1)$: F' and Q share exactly one edge.

Let R be a C_6^* adjacent to P in F' and Q share an edge with P . The only two possibilities, keeping the maximality of F' , are as in Figure 5.10. Now, all the type II vertices of P can be identified using Lemma 5.3.6 and hence all the vertices in F' .

Case $B-(II)(2)$: F' and Q share more than one edge.

Let Q share its edges to more than one C_6^* in F' , otherwise it can be treated as in Case $A-II(1)$.

Let Q share its edges to P and R . Since x_i, y_i , for $i \equiv 0 \pmod{4}$ are type II in F' , and Q share consecutive edges of it, two vertices at distance 2 can be identified to be type II and hence the vertex in common to these vertices is type I and thus all the other vertices in P, Q and F' are identified. Since P is an arbitrary C_6^* in F , all the vertices in F can be identified.

□

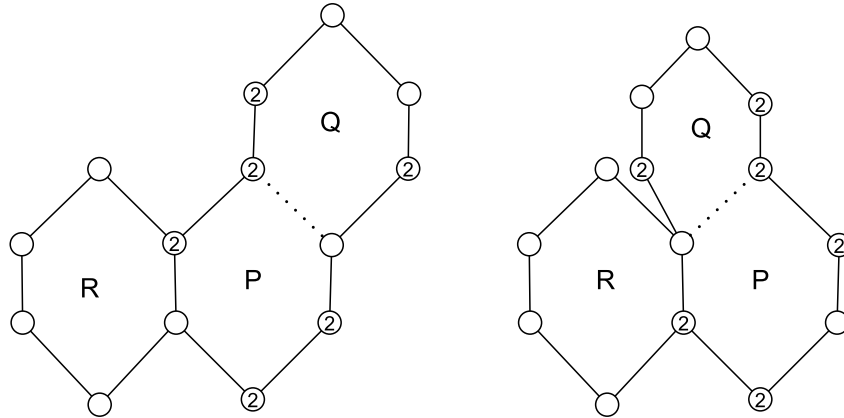

Figure 5.10: Illustration of Case $B - (II)(1)$ in Theorem 5.3.13.

5.4 Identifying the types of triangles in H

Two triangles uvw and xyz in H are in relation \mathcal{N} , denoted by $uvw\mathcal{N}xyz$, if they share an edge, that is if $|\{u, v, w\} \cap \{x, y, z\}| = 2$. Two triangles uvw and pqr in H are in relation θ , denoted by $uvw\theta pqr$, if there is a triangle xyz in H such that $uvw\mathcal{N}xyz$ and $xyz\mathcal{R}pqr$, provided both xyz and pqr are not type II. Thus when uvw is type I, xyz is type II and pqr is type I. Also, uvw and pqr can be identified as the disjoint triangles induced in a subgraph $2K_1 \vee C_4$ of H .

Lemma 5.4.1. *Let uvw be a type I triangle in H and let $H \cong \text{antiGal}(K_4)$. Then, the triangle uvw is in relation θ with all the type I triangles in H .*

Proof. Let \bar{x}, \bar{y} and \bar{z} be the edges other than \bar{u}, \bar{v} and \bar{w} in $G \cong$

K_4 and $\bar{x}\bar{y}\bar{u}$ be a triangle in G . Without loss of generality let \bar{x} adjacent to \bar{u} and \bar{v} . Then $uvw\mathcal{N}uvz$ and $uvz\mathcal{R}xyu$ implies $uvw\theta xyu$. Now, a similar set of arguments prove the assertion. \square

Lemma 5.4.2. *If $uvw\theta pqr$, then $pqr\theta uvw$.*

Proof. Let xyz be the triangle such that $uvw\mathcal{N}xyz$ and $xyz\mathcal{R}pqr$. Assume without loss of generality that $u = y, v = z$ and $x \neq w$. Then we have $uvx\mathcal{R}pqr$. Also, assuming $p \in N^*(uv)$, p cannot be adjacent to x and hence $p = w$. Here uvw, xyz and pqr are triangles and $u = y, v = z$ and $p = w$, hence $q \in N^*(uw), r \in N^*(vw)$ together with $x \in N^*(uv)$ and $|\{u, v, w, x, q, r\}| = 6$ implies that $xqr \in N'(xqr)$ or $xqr\mathcal{R}uvw$. since $x \neq w$, we have $pqr\mathcal{N}xqr$ and $xqr\mathcal{R}uvw$ and hence $pqr\theta uvw$. \square

Two triangles t and s in H are in relation θ^* , denoted by $t\theta^*s$, if there is a sequence of triangles t_1, t_2, \dots, t_k such that $t\theta t_1\theta t_2\theta \dots \theta t_k\theta s$. In this case we say that s is θ -reachable from t . It follows from Lemma 5.4.2 that the relation θ^* is also symmetric in the set of type I triangles in H .

We now label the vertices in B_H in the following way. Consider each MTI subgraph S in H . Note that when $|V(S)| = 6$, all the components of B_S are K_2 and the vertices of which can be labelled by giving a label type I to a vertex and then applying

θ .

(1) Give an initial labelling to the vertices using Lemma 5.3.6 and Theorem 5.3.13 and relation \mathcal{N} . Now, consider the non-labelled vertices in B_S .

(2) Then each of the remaining vertices are either in a K_2 or a graph in \mathcal{F} . In this case at least one end vertex of any K_2 is in relation \mathcal{N} with a vertex in a component, which is in \mathcal{F} .

(3) Consider a component which is in \mathcal{F} . Give a labelling to the vertices in that component as in Theorem 5.3.11. Now using \mathcal{N} , type II vertices in one end of each K_2 are identified and hence the other end.

We can see that the statement (2) holds if there are non-labelled vertices remaining in B_S . Hence it is possible to repeat (3) until all the vertices in B_S , and hence in B_H , are labelled.

Theorem 5.4.3. *Let uvw be a type I triangle in a MTI subgraph S of an anti-Gallai graph H . Then the set of all type I triangles in S are θ -reachable from uvw .*

Proof. The result is true when $|S| \leq 6$, by Lemma 5.4.1. Let $|S| > 6$ and K be the set of all vertices of the θ -reachable triangles from uvw . It suffices to show that any type I triangle in $\langle K \rangle$ is θ -reachable from the triangle uvw and K induces the MTI subgraph containing uvw .

To prove the first part, let xyz be a triangle in $\langle K \rangle$ which

is θ reachable from uvw . Now x is vertex in some θ -reachable triangle from uvw . Let xpq be the triangle such that $uvw\theta^*xpq$. Since p is a neighbor of xyz , a type I triangle, it must be a common neighbor of an edge of xyz . Let p be adjacent to x and y and hence xpy is a triangle. Since no two type I triangles share an edge, xpy is a type II triangle.

With similar arguments we can show that xqz is also a type II triangle. Since z and q are adjacent, we have \bar{z} and \bar{q} uniquely determine a triangle $\bar{z}\bar{q}\bar{r}$ in G . Now we have p is a neighbor of q but not to z , adjacent to r , since xqr is a type I triangle. With the same argument since xyz is a type I triangle, r must be adjacent to x or y . If r is adjacent to x , then $r \in N^*(xpq)$ is a contradiction to the assumption that xpq is a type I triangle. So r is adjacent to y .

Now we have $zqr \in N'(pxy)$ and is unique. Since pxy is in relation \mathcal{N} with both xyz and xpq , we have $xyz\theta zqr$ and $xpq\theta zqr$. Since $uvw\theta^*xpq$ and θ is symmetric, $uvw\theta^*xyz$.

$\langle K \rangle$ is triangle-irreducible from the definition of K . We just need to show that $\langle K \rangle$ is maximal. For, let $\langle K' \rangle$ be a triangle-irreducible subgraph, where K' contains K as a proper subset. Let t be a vertex in $K' \setminus K$ such that t is adjacent to a vertex in K . Since any vertex in K is in some type I triangle,

we have t is adjacent to a triangle, xyz in K . But t must be a common neighbor of an edge of xyz . Let t be a common neighbor of the edge xz . Now as in Lemma 5.2.4, there exist vertices t' and t'' uniquely determined by t such that $tt't''$ is a type II triangle. Without loss of generality assume that t' is adjacent to z . So $xyz\mathcal{N}yzt'$ and $yzt'\mathcal{R}xtt''$ and that $xyz\theta xtt''$. By the transitivity of θ^* , $uvw\theta^*xtt''$, which is a contradiction to the assumption that $t \notin K$. Hence we have $\langle K \rangle$ is MTI.

□

Corollary 5.4.4. *Let uvw be a type I triangle in H . A triangle in the same MTI subgraph containing uvw is a type I triangle if and only if it is θ -reachable from uvw .*

5.5 Root graphs of anti-Gallai graphs

In this section we discuss the root graphs of anti-Gallai graphs which are triangle-irreducible. Recall from Section 4.4 that, a triangle uvw in $L(G)$ is type A if its corresponding edges \bar{u} , \bar{v} and \bar{w} induce a triangle in G and uvw is type B otherwise. Thus all type I triangles in $antiGal(G)$ is type A in $L(G)$ and vice versa.

Given a graph H , give a type I or type II label to the triangles in H . The following algorithm checks the necessary conditions, given in Theorem 4.2.4, for a triangle to be type A and thus

provide adjacencies for a type I triangle in H to be a type A triangle in $L(G)$.

Let $M = \{z, u\}$, where zu is an edge in H . Let J be a graph with $V(J) = V(H)$ and G be a path on three vertices with $V(G) = \{\{z\}, \{z, u\}, \{u\}\}$ and $E(G) = \{(\{z\}, \{z, u\}), (\{z, u\}, \{u\})\}$. Here the vertices of G are represented as sets which changes under set operations.

1. Choose a vertex v from $V(H) \setminus M$ with $N_M(v) \neq \emptyset$.
2. If v induces a clique in $N_M(v)$ and do not induce a type I triangle, then find a vertex $C \in V(G)$ with $N_M(v) \subseteq C$. Choose one at random if more than one such vertex is available.
 - (a) In G , join $\{v\}$ with C and make $V(G) = V(G) \cup \{v\}$, $M = M \cup \{v\}$ and $C = C \cup \{v\}$.
 - (b) In J , make the vertex v adjacent to the set of all vertices in $C \setminus N_M(v)$.
3. Else find two vertices A and B in $V(G)$ such that $N_M(v) \subseteq A \cup B$. Choose one pair of A and B if more than one such pair are available.
 - (a) In G , make $M = M \cup \{v\}$, $A = A \cup \{v\}$ and $B = B \cup \{v\}$.

- (b) In J , make the vertex v adjacent to the set of all vertices in $(A \cup B) \setminus N_M(v)$.
4. If $M = V(H)$, then stop. Else, go to step 1.

The algorithm ends whenever $M = V(H)$ or there does not exist C or A and B as required. In the former case, the graph G obtained at the end of the algorithm is such that $\text{antiGal}(G) \cong H$. Also, if we start with $J \cong H$ then we obtain $J \cong L(G)$ at the end of the algorithm. In the latter case it can be concluded that the graph H is not an anti-Gallai graph of any graph. Thus the above algorithm can also be used as a recognition algorithm for triangle irreducible anti-Gallai graphs.

Concluding Remarks

In this thesis the root graphs of some graph operators are studied. We have shown the existence of root graphs of different graph classes and provided solutions to some of the existing problems in graph theory. The solutions to the problems of finding common root graphs of median, anti-median, center operators are also given. An algorithm to find the root line graph based on a partition on the edge set of a line graph is provided. This algorithm is extended to find the root graphs of a triangle irreducible anti-Gallai graph, the triangles of which have a partition to two types depending on its structure.

We list below some problems which we found are interesting, but could not be attempted for various reasons.

1. Given three k -partite graphs G_1, G_2 and G_3 , find a k -partite graph H such that $M(H) \cong G_1$, $AM(H) \cong G_2$ and $C(H) \cong G_3$.

2. Check the existence of the graph of the form (G_1, G_2, r) with a prescribed center, for $r \geq 1$.
3. Find the relation between $M(G^k)$ and $M(G)^k$. Similarly for AM operator.
4. Find upper bounds of $SD(G)$ in different graph classes.
5. Find root line graphs of some more graph classes.

Bibliography

- [1] A. V. Aho, J. E. Hopcroft and J. D. Ullman, The design and analysis of computer algorithms, *Addison Wesley*, (1976).
- [2] P. Anand, H. Escudro, R. Gera, S. G. Hartke and D. Stolee, On the hardness of recognizing triangular line graphs, *Discrete Math.*, 312(2012), 2627-2638.
- [3] L. S. Aparna , S. B. Rao and A. Vijayakumar, Gallai and anti-Gallai graphs of a graph, *Math. Bohem.*, 132(1) (2007), 43 - 54.
- [4] L. S. Aparna, B. Csilla and Z. Tuza, Generalized line graphs: Cartesian products and complexity of recognition, *Electron. J. Combin.*, Volume 22, Issue 3 (2015), paper # P3.33.
- [5] K. Balakrishnan, B. Brešar, M. Changat, S. Klavžar, M. Kovše and A. R. Subhamathi, Simultaneous embeddings of graphs as median and antimedian subgraphs, *Networks* 56(2010), 90-94.

-
- [6] R. Balakrishnan and K. Ranganathan, *A Textbook of Graph Theory*, Second edition, Heidelberg: Springer (2012).
- [7] P. Baldi, P. Frascioni and P. Smyth, *Modeling the Internet and the Web*, John Wiley (2003).
- [8] H. J. Bandelt and H. M. Mulder, Distance-hereditary graphs, *J. Combin. Theory Ser., B* 41(1986), 182-208.
- [9] L. W. Beineke, On derived graphs and digraphs, *Beitrage zur Graphentheorie*, Leipzig, (1968), 17 - 23.
- [10] H. Bielak and M. M. Syslo, Peripheral vertices in graphs, *Studia Sci. Math. Hungar.* 18(1983), 269-275.
- [11] A. Brandstdt, V. B. Le and J. P. Spinrad, *Graph Classes a Survey*, SIAM Monographs in Discrete Mathematics and Applications, SIAM, Philadelphia (1999).
- [12] F. Buckley and F. Harary, *Distance in Graphs*, Addison-Wesley, Redwood City, CA(1990).
- [13] F. Chung, Graph theory in the information age, *Notices Amer. Math. Soc.*, 57, no. 6(2010), 726-732.
- [14] A. D'Atri and M. Moscarini, Distance hereditary graphs, Steiner trees, and connected domination, *SIAM J. Comput.*, 17 (1988), 521 - 538.

-
- [15] P. Dankelmann and G. Sabidussi, Embedding graphs as isometric medians. *Discrete Appl. Math.* 156(2008), 2420-2422.
- [16] D. R. Fulkerson and O. A. Gross, Incidence matrices and interval graphs, *Pacific J. Math.*, 15(1965), 835-855.
- [17] T. Gallai, Transitiv Orientierbare Graphen, *Acta Math. Hungar.* 18 (1967), 25-66.
- [18] A. J. Goldman, Optimal center location in simple networks, *Trans. Sci.* 5 (1971), 212-221.
- [19] A. J. Goldman, Minimax location of a facility in a network, *Trans. Sci.* 6 (1972), 407-418.
- [20] S. L. Hakimi, Optimum location of switching centers and the absolute centers and medians of a graph, *Oper. Res.* 12 (1964), 450-459.
- [21] G. R. T. Hendry, On graphs with prescribed median I, *J. Graph Theory*, 9(1965), 477-481.
- [22] K. S. Holbert, A note on graphs with distant center and median, *Recent Studies in Graph Theory* (1989), 155-158.
- [23] E. Howorka, A characterization of distance-hereditary graphs, *Q. J. Math. Oxford. Ser.*, 28(1977), 417-420.
- [24] L. H. Hsu and C. K. Lin, *Graph Theory and Interconnection Networks*, CRC Press, (2009).

-
- [25] C. Jordan, Sur les assemblages de lignes, *J. Reine Angew. Math*, 70(1869), 185-190.
- [26] H. Kautz, B. Selman and M. Shah, Referral Web: Combining social networks and collaborative filtering, *Communications of the ACM* 40(3)(1997), 63-65.
- [27] M. Knor, L. Niepel and L. Soltes, Centers in line graphs, *Math. Slovaca* 43 (1993), 11-20.
- [28] J. Krausz, Démonstration nouvelle d'une théorème de Whitney sur les réseaux, *Mat. Fiz. Lapok* 50(1943), 75 - 85.
- [29] R. Laskar and D. Shier, On powers and centers of chordal graphs, *Discrete Appl. Math.* 6 (1983), 139-147.
- [30] V. B. Le, Gallai graphs and anti-Gallai graphs, *Discrete Math.*, 159 (1996), 179 - 189.
- [31] P. G. H. Lehot, An optimal algorithm to detect a line graph and output its root graph, *J. ACM*, 21(1974), 569-575.
- [32] Z. Miller, Medians and distance sequences in graphs, *Ars Combin.*, 15(1983), 169-177.
- [33] S. M. Hedetniemi, S. T. Hedetniemi and P. J. Slater, Centers and medians of $C(n)$ -trees, *Util. Math.* 21 (1982), 225-234.

-
- [34] J. C. Nacher, U. Ueda, T. Yamada, M. Kanehisa and T. Akutsu, Line graphs as social networks, *BMC Bioinformatics* 24(207)(2004), 2611-2618.
- [35] J. C. Nacher, T. Yamada, S. Goto, M. Kanehisa and T. Akutsu, Two complementary representations of a scale-free network. *Physica A: Statistical Mechanics and its applications* (2005), 349-363.
- [36] O. Ore, *Theory of Graphs*, Amer.Math.Soc.Coll.Publ.38, Providence(R.I.)(1962).
- [37] I. M. Pelayo, *Geodesic Convexity in Graphs*, Springer New York(2013).
- [38] K. Pravas and A. Vijayakumar, The median problem on k -partite graphs, *Discuss. Math. Graph Theory*, 35 (2015), 439-446.
- [39] K. Pravas and A. Vijayakumar, Convex median and anti-median at prescribed distance, *J. Comb. Optim.*(2016), 1-9. (doi:10.1007/s10878-016-0022-z)
- [40] K. Pravas and A. Vijayakumar, On an edge partition and root graphs of some classes of line graphs(Communicated).
- [41] K. Pravas and A. Vijayakumar, On median problem on symmetric bipartite graphs, *Lecture Notes in Comput. Sci.*(Proceedings of the International Conference on

- Theoretical Computer Science and Discrete Mathematics, Kalasalingam University, Krishnankoil, 2016). (to appear).
- [42] K. Pravas and A. Vijayakumar, On the root graphs of triangle-irreducible anti-Gallai graphs(Communicated).
- [43] E. Prisner, Graph dynamics, Longman (1995).
- [44] A. Proskurowski, Centers of maximal outerplanar graphs, J. Graph Theory 4 (1980), 75-79.
- [45] A. Proskurowski, Centers of k -trees, Univ. Oregon Technical Report CS-TR-79-9(1979).
- [46] S. B. Rao and A. Vijayakumar, On the median and the anti-median of a cograph, Int. J. Pure Appl. Math. 46(5)(2008), 703-710.
- [47] N. D. Roussopoulos, A $\max\{m, n\}$ algorithm for detecting the graph h from its line graph G , Inform. Process. Lett. 2, (1973)108-112.
- [48] P. J. Slater, Medians of arbitrary graphs, J. Graph Theory 4 (1980), 389-392.
- [49] C. Smart and P. J. Slater, Center, median and centroid subgraphs, Networks, 34, 4 (1999), 303-311.
- [50] J. L. Szwarcfiter, A survey on clique graphs, Recent advances in Algorithms and Combinatorics (2003), 109-136.

-
- [51] L. Sun, Two classes of perfect graphs, *J. Combin. Theory Ser. B* 53(1991), 273 - 292.
- [52] B. C. Tansel, R. L. Francis and T. J. Lowe, Locations on networks: A survey, parts I and II, *Mgmt Sci* 29 (1983), 482-497, 498-511.
- [53] M. Truszczyński, Centers and centroids of unicyclic graphs, *Math. Slovaca*, 35 (1985), 223-228.
- [54] H. Whitney, Congruent graphs and the connectivity of graphs, *Amer. J. Math.* 54(1932), 150 -168.
- [55] S. J. Winters, Connected graphs with prescribed median and periphery, *Discrete Math.*, 159(1996), 223-236.
- [56] J. Xu, *Topological structure and analysis of interconnection networks*, Kluwer Academic Publishers(2001).
- [57] H. G. Yeh and G. J. Chang, Centers and medians of distance-hereditary graphs, *Discrete Math.* 265(2003), 297-310.
- [58] B. Zelinka, Medians and peripherians of trees, *Arch. Math (Brno)* (1968), 87-95.

Index

- anti-Gallai, 8
 - base graph, 105
- anti-median, 6
- base graph, 105
- BFS tree, 5, 50
- bipartite gadget graph, 18
- bipartite graph of G , 41
- center, 5
- chordal, 7
- claw, 7
- clique, 5
- corona, 100
- Gallai, 8
- graph
 - k -partite, 6
 - chordal, 91
 - bipartite, 7
 - \mathcal{C} -free, 5
 - chordal, 7
 - complete k -partite, 6
 - diameter-maximal, 89
 - distance-hereditary, 91
 - H -free, 5
 - ladder, 7
 - Ptolemaic, 91
 - symmetric bipartite, 7
- graph operator, 8
 - $AM(G)$, 6
 - $antiGal(G)$, 8
 - $B(G)$, 41
 - B_H , 105
 - $C(G)$, 5
 - $Gal(G)$, 8
 - $L(G)$, 8
 - $M(G)$, 6
 - $P(G)$, 5
 - G^2 , 45

- hanging, 72
 - supporter, 72
- join, 5
- line graph, 8
- maximum status difference, 6
- median, 6
 - anti-median, 6
- MTI, 100
- perfect elimination ordering, 92
- periphery, 5
- root graph, 3, 8
 - root line graph, 8
- root line graph, 8, 71
 - chordal, 97
 - diameter maximal, 90
 - distance-hereditary, 92
 - Ptolemaic, 97
- simplicial, 92
- square of a graph, 45
- square-subgraph, 45
- star, 7
- status, 5
- subgraph
 - induced, 5
- symmetric bipartite gadget graph, 37
- triangle
 - type A, 86
 - type B, 86
 - type I, 100
 - type II, 101
- triangle-irreducible, 100
 - maximal, 100
- triangle-reducible, 100

List of Publications

Papers Presented

1. The Median(Antimedial) problem for bipartite graphs, National Seminar on Discrete Mathematics and Applications, St. Paul's College, Kalamasseri, 7-9, Aug. 2008.
2. On an edge partition of line graph, The Platinum jubilee 75th Annual Conference of the Indian Mathematical Society(IMS), Kalasalingam University, Krishnankoil, 27-30, Dec.2009.
3. Root graphs of anti-Gallai graphs, The International Congress of Mathematicians (ICM-2010), University of Hyderabad, 19-27, Aug.2010.
4. Convex Median and Anti-Median at Prescribed distance, the Indo-Slovenia Conference on Graph Theory and Applications (Indo-Slov-2013), Department of Futures Studies, Kerala University, Trivandrum, 22-24, Feb.2013.
5. The median problem on k-partite graphs, the international Conference on Algebra and Discrete Mathematics (ICADM-2014), Department of Mathematics, Government College, Kattappana, 4-6, March 2014.

6. The Median problem on symmetric bipartite graphs (accepted for presentation in the International Conference on Theoretical Computer Science and Discrete Mathematics, Kalasalingam University, Krishnankoil, 19-21, Dec.2016.)

Papers published / communicated

1. K. Pravas, A. Vijayakumar, The median problem on k-partite graphs, *Discuss. Math. Graph Theory*, 35 (2015), 439-446.
2. K. Pravas, A. Vijayakumar, Convex median and anti-median at prescribed distance, *Journal of Combinatorial optimization*(2016), 1-9. (doi:10.1007/s10878-016-0022-z)
3. K. Pravas, A. Vijayakumar, On an edge partition and root graphs of some classes of line graphs(Communicated).
4. K. Pravas, A. Vijayakumar, On median problem on symmetric bipartite graphs, *Lecture Notes in Computer Science* (Proceedings of the International Conference on Theoretical Computer Science and Discrete Mathematics, Kalasalingam University, Krishnankoil, 2016). (to appear).
5. K. Pravas, A. Vijayakumar, On the root graphs of triangle-irreducible anti-Gallai graphs(Communicated).

CURRICULUM VITAE

Name : Pravas K.

Present Address : Department of Mathematics
CUSAT
Cochin, Kerala, India-682 022.

Official Address : Assistant Professor
Department of Mathematics
K.K.T.M. Govt. College
Pullut, Kerala, India-680 663.

Permanent Address : Sougandhikam
Sree Narayana Road
Elamakkara
Kochi, Kerala, India-682 026.

Email : pravask@gmail.com

Qualifications : **B.Sc.** (Mathematics), 2003,
M.G. University, Kottayam, India.

M.Sc. (Mathematics), 2005,
CUSAT, Cochin, India.

NET & Junior Research Fellowship, 2005
University Grants Commission, India.

Research Interest : Graph Theory.