

G78228



**GILL NETS OF KERALA:**  
**A STUDY ON TECHNOLOGICAL AND OPERATIONAL ASPECTS**

*Thesis submitted to the*  
**COCHIN UNIVERSITY OF SCIENCE AND TECHNOLOGY**

*in partial fulfilment of the requirements for  
the Degree of*

**DOCTOR OF PHILOSOPHY**

*by*

**SALY N. THOMAS**

**School of Industrial Fisheries  
Cochin University of Science and Technology  
Cochin - 682 016**

**2001**

*Dedicated to  
My Parents*

## DECLARATION

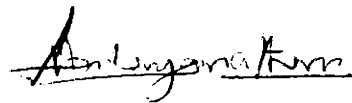
I, Saly N. Thomas, do hereby declare that the thesis entitled “**Gill Nets of Kerala: A Study on Technological and Operational Aspects**” is an authentic record of research work carried out by me under the supervision and guidance of **Prof. (Dr.) C. Hridayanathan**, Director, School of Industrial Fisheries, Cochin University of Science and Technology, in partial fulfilment of the requirements for the Ph.D degree in the Faculty of Marine Science and that no part of it has previously formed the basis of the award of any degree, diploma, associateship, fellowship or any other similar title of any University or Institution.

Cochin-682 016,  
May 2001.

  
**Saly N. Thomas**

## CERTIFICATE

This is to certify that the thesis entitled “**Gill Nets of Kerala: A Study on Technological and Operational Aspects**” is an authentic record of the research work carried out by **Smt. Saly N. Thomas** under my supervision and guidance at the School of Industrial Fisheries, Cochin University of Science and Technology, in partial fulfilment of the requirements for the degree of **Doctor of Philosophy** of the Cochin University of Science and Technology, and that no part thereof has been submitted for any other degree.



**Dr. C. Hridayanathan**  
Director,  
School of Industrial Fisheries,  
Cochin University of  
Science and Technology,  
Cochin – 682 016.

Cochin-682 016,  
May 2001.



## ACKNOWLEDGEMENT

I express my sincere gratitude to Prof. Dr.C.Hridyanathan, Director, School of Industrial Fisheries for his guidance and encouragement as my research supervisor and for providing necessary facilities.

My sincere thanks are also due to Prof. Dr. M.Shahul Hameed former Director, School of Industrial Fisheries for his help and valuable suggestions. Dr. K. Ravindran, former Director, Central Institute of Fisheries Technology (CIFT), has kindly granted me the sabbatical. I remember with thanks the help and support rendered to me by Dr. K. Devadas, Director, CIFT and Dr. B. Meenakumari, Head, Fishing Technology Division of CIFT.

Shri. H. Krishna Iyer, Principal Scientist (Retd.), and Shri. V. Annamalai, Sr.Scientist, CIFT, rendered substantial help in data analysis. Thanks are also due to Drs. M.D.Varghese, V.C.George, Leela Edwin, and to Shri. Shankar T.V.and Muhamad Ashraf, P. scientists of CIFT for their help and encouragement. A special word of thanks to Shri. P. Pravin, my colleague at CIFT, who laboured on the computer and helped me in the preparation of this thesis. The help extended by J. Shyma, Ranjit K. and other fellow research scholars of the School of Industrial Fisheries deserve special mention.

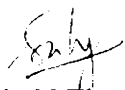
I cannot but remember with thanks the kind help rendered by Shri. Ramesh, (Manager, Garware Wall Ropes, Cochin), Smt.Geetha (Project Officer, Matsyafed, Nattika), Shri, Xavierkutty (Secretary, Fishermen Welfare Society, Omanapuzha) and Smt. Omana, B. (Secretary, Fishermen Welfare Society, Chellanam).

The fishermen of Kerala coast: had they not opened their mind, this study would not have taken place.

I also remember my husband Joy and my children Kannan and Appu for the many sacrifices they had to make during the period of my study.

To all of them and to others I may have inadvertently failed to mention, I am most thankful.

Cochin - 682 016  
May 2001

  
Saly N.Thomas

# CONTENTS

## CHAPTER I

1.	INTRODUCTION	1
1.1.	Small - scale fisheries	2
1.2.	Selective and low energy fishing	4
1.3.	Gill nets	5
1.4.	The Indian context	7
1.5.	Review of literature	9
1.6.	Background of the study	15
1.7.	Scope and objectives	18

## CHAPTER II

2.	MATERIALS AND METHODS	20
2.1.	Data base	20
2.2.	Base line survey	21
2.3.	Research sites	22
2.4.	Sampling	24
2.5.	Data collection and analysis	25
2.5.1.	Experimental aspects	25
2.5.1.1.	Photodegradation of gill net materials	25
2.5.1.2.	Materials substitution in seer gill nets	26
2.5.1.3.	Selectivity	27
2.5.2.	Technical Specification of nets	28
2.5.2.1.	Design and technical details	28
2.5.2.2.	Presentation of design drawings	29
2.5.3.	Techno- economic aspects	30

## CHAPTER III

### 3. DESIGN AND TECHNICAL CHARACTERISTICS 32

#### *SECTION 1*

3.1.	Classification and description of nets	32
3.1.1.	Introduction	32
3.1.2.	Materials and methods	35
3.1.3.	Results and discussions	36
3.1.3.1.	Classification of gill nets	36
3.1.3.2.	Design and technical specifications	37
3.1.3.3.	Operational aspects	58
3.1.3.3.1.	Fishing operations	58
3.1.3.3.2.	Craft	59
3.1.3.3.3.	Manpower	61
3.1.3.3.4.	Trip duration	61

#### *SECTION 2*

3.2.	Evaluation of design aspects	63
3.2.1.	Introduction	63
3.2.2.	Materials and methods	66
3.2.3.	Results and discussion	69
3.2.3.1.	Twine size and mesh size relationship	69
3.2.3.2.	Mode of capture of fishes	71
3.2.3.3.	Buoyancy weight relationship	71
3.2.3.4.	Distribution of floats	75

## CHAPTER IV

4.	PHOTODEGRADATION IN GILL NET MATERIALS	76
4.1.	Introduction	76
4.2.	Materials and methods	79
4.3.	Results and discussion	81
4.3.1.	Assessment of mechanical strength properties	81
4.3.1.1.	Loss in mechanical strength properties	81

4.3.1.2.	Effect of thickness of material on degradation	86
4.3.2.	Assessment of degradation by IR spectroscopy	90
4.3.2.1.	Characteristics absorbance of polyethylene	90
4.3.2.2.	Characteristics absorbance of polyamide	93

## CHAPTER V

5.	MATERIAL SUBSTITUTION IN GILL NETS FOR SEER AND TUNA	97
5.1.	Introduction	97
5.2.	Materials and methods	100
5.3.	Results and discussion	103
5.3.1.	Over view of catch	103
5.3.2.	Size distribution	105
5.3.3.	Assessment of comparative durability of the nets	106
5.3.4.	Cost effectiveness of the new net	107
5.3.5.	Estimate of manpower requirements	108

## CHAPTER VI

6.	SELECTIVITY	109
----	-------------	-----

### SECTION 1

6.1.	Selectivity estimates for <i>Sardinella longiceps</i> , <i>Otolithes argenteus</i> and <i>Penaeus indicus</i>	109
6.1.1.	Introduction	109
6.1.2.	Materials and methods	113
6.1.3.	Results and discussion	116
6.1.3.1.	<i>Sardinella longiceps</i>	116
6.1.3.2.	<i>Otolithes argenteus</i>	120
6.1.3.3.	<i>Penaeus indicus</i>	123

### SECTION 2

6.2.	Catch analysis in small mesh gill nets	127
6.2.1.	Introduction	127
6.2.2.	Materials and methods	128

6.2.3.	Results and discussion	129
6.2.3.1.	Seasonal variation in use of mesh sizes	129
6.2.3.2.	Catch characteristics	130
6.2.3.3.	Proportion of juveniles	131
<b>CHAPTER VII</b>		
7.	<b>TECHNO-ECONOMIC ANALYSIS</b>	137
7.1.	Introduction	137
7.2.	Materials and methods	140
7.2.1.	Selection of technologies	140
7.2.2.	Selection of centres and sample units	142
7.2.3.	Fishing practices	142
7.2.4.	Data collection and analysis	144
7.3.	Results and discussion	145
7.3.1.	Technical efficiency	145
7.3.1.1.	Effort	145
7.3.1.2.	Productivity	150
7.3.2.	Economic efficiency	153
7.3.2.1.	Investment profile	153
7.3.2.2.	Cost of production	156
7.3.2.3.	Economic performance	161
<b>CHAPTER VIII</b>		
8.	<b>SUMMARY AND RECOMMENDATIONS</b>	173
8.1.	Summary	173
8.2.	Recommendations	177
	<b>REFERENCES</b>	181

## **Chapter 1**

### **Introduction**

## Chapter 1

### INTRODUCTION

The fishing industry the world over is passing through a critical situation. World's marine fish catch has increased more than four times from 18.5 million tonnes in 1950 to 86.1 million tonnes by 1997. However, in 1998 there was a drastic decline of 7.82 % from 1997 catch (FAO, 2000). In 1989 itself production had reached this level and 1989 to 1997 showed a highly fluctuating situation. The landings of marine fishes seemed to have reached saturation in major fishing areas of the world.

New technologies, declaration of Exclusive Economic Zone (EEZ) and the 1982 UN Convention of the Law of the Sea (UNCLOS) have brought about drastic changes in the management of fisheries which resulted in enhanced access and significant expansion of effort and production (Ahmed, 1999). Today, the industry is twice as large as it is necessary. It could go back to the conditions of 1970 and still produced the same yield. The unrestrained development resulted in overexploitation, and the consequent depletion of certain species. It also caused disturbances in the natural ecosystem and even threatened the

biodiversity. Weber, (1994) identified overfishing, destructive fishing practices, pollution and coastal development as the major causes for these. Concurrent with this, the ever-increasing price of oil grabbed the fishermen off their profit. Recognizing that fisheries should be conducted in a responsible manner, the Food and Agriculture Organization (FAO) of the United Nations has developed an *International Code of Conduct for Responsible Fishing*, in consultation with member countries (FAO, 1995). While considering the guidelines of the 'Code' the need for concentrating more, on those artisanal and small-scale fishing methods, which use selective and energy efficient fishing gears is becoming more urgent and essential.

### **1.1. Small-scale Fisheries**

The definition of small fishing craft differs from country to country depending on the technological level of its fishery (Ben Yami, 1989). As a general rule fisheries employing fishing gear and techniques used by small scale and artisanal fishermen either from shore or from onboard small fishing craft come under small-scale fisheries. There are around 0.25 million large-scale fishermen and 14-20 million small-scale fishermen in the world (Weber, 1994). The small-scale fishermen for the same amount of fish landed, use more



indigenous techniques, and provide more employment and better social benefits, which are more equitably distributed than the large-scale fishermen. They are less likely to overfish and require less expenditure on capital investment, energy, equipment, infrastructure and foreign currency (Ben-Yami and Anderson, 1985). The advantages of small-scale fisheries and its socioeconomic aspects have been widely discussed (Thomson, 1980; Yater 1982; Panayotou *et al.*, 1985; Tokrishna *et al.*, 1985; Fredericks and Nair 1985; Ben Yami, 1989; Weber, 1994 and Jayantha and Amarasinghe, 1998).

However, the concept on small-scale fisheries' as an energy efficient sector using selective fishing methods is fast changing. The marine capture fishery the world over is becoming more and more industrialised even in the small-scale sector. Presently adoption of smaller versions of trawls and seines used by the large scale sector and use of very small mesh sizes for various gear are common in small-scale sector. To overcome the present crisis in the fishing industry throughout the world, selective fishing methods, which utilize less energy, are needed.

## **1.2. Selective and Low energy fishing**

Selectivity is the ability to target and capture fish by species, size, or a combination of these during harvesting operations allowing release of all incidental bycatch which may include undersized and non-target fish species, birds, mammals and other organisms encountered during fishing operations (Anon, 1995). Fishing gears such as gill nets, lines and traps are basically more selective than others such as trawls and seines.

Low energy fishing is technically a relative concept and it should always be related to well-defined situations or systems (BenYami, 1993). In certain cases low energy fishing is used as a synonym for non-industrial, small scale or artisanal fishing. Low energy fishing such as gill netting, lining and trap fishing neither expend fuel for towing heavy nets nor damage fishing ground. The fishes captured by these are of large average size and of better quality since they are handled individually (Johnstone and Mackie, 1986). Relatively large vessels are now increasingly using such techniques as gill netting previously used mainly in small-scale operations (Ben Yami, 1988). In the present context of rapid industrial fishery developments more efficient engines are developed, but savings can only be achieved by more fuel-

efficient fishing techniques (Brandt, 1984). International bodies especially FAO has always been conscious of how the cost and availability of energy affects food production (Fitzpatrick, 1989). Trawling, a highly energy intensive fishing consumed 0.8 kg of fuel while longlining and gill netting consumed between 0.15 and 0.25 kg of fuel and purse seining required 0.07 kg of fuel for 1 kg of fish caught (Gulbrandsen, 1986).

Gill netting is the most important selective and low energy fishing technique practiced by artisanal fishermen. In world fisheries, gill nets – bottom set and drifting – rank next to trawls and purse seines in terms of total catch.

### **1.3. Gill Nets**

Worldwide, 20 % of the fish catching methods are gill netting. Eventhough the origin of gill net fishing cannot be traced with certainty, gill nets of one form or other, have been in continuous use around the world. The earliest evidence came from herring driftnets of North Sea by the 11<sup>th</sup> and 12<sup>th</sup> centuries (Northridge, 1991). Gill nets are among the simplest and oldest methods of fishing. The nets are operated by gilling or entangling fish in the meshes of a sheet of netting. The net is left to fish passively as fishes are being caught

when they swim into it and the mesh of the net becomes caught behind its gills, hence the name 'gill nets'. The netting is held more or less vertically in the water column by means of a buoyant floatline at the top and weighted leadline at the bottom of the unit. The nets usually joined together serially as a fleet of nets are set to the bottom through anchors or sinkers or allowed to drift along with the boat to which one end of the net is tied. The net is positioned in the surface, column or bottom of the water depending on the swimming layer of the target species. Gill net is the only gear in which the 'mesh' of the gear itself serves the dual function of catching fish and selecting the fish to be caught (Anon, 1994).

The principles behind gill netting have not changed over the years but the equipment and materials have changed. It is widely recognized as an efficient and 'selective' type of gear (Bjoringsoy, 1996). It is relatively cheap and is very easy to operate, principally because, relatively low powered vessels can be used to deploy it which makes it fuel efficient. The introduction of trawls and purse seines gave a low profile to gill net fishing. However, it still remains as one of the most depended upon gear by maximum fishermen due to its lower capital investment, its simple design and construction procedure. It is one of those fishing methods with a low energy

consumption calculated on the relationship of fuel /fish both in kg (Brandt, 1984) The relationship is similar to that of long lining (Endal, 1979).

Gill netting being a low cost fishing method is of special interest for artisanal fisheries. It needs minimum investment on nets and can be operated even without a vessel or with a rowing boat or simple motor boats with a low power. Since only a small crew and a relatively small number of nets are required, this method is widely practised around the world. Gill net fishing is playing an important role in the promotion of coastal fisheries (Anon, 1979). Presently, Japanese coastal fishermen are enjoying a stable fishing life by mainly catching coastal demersal fishes and the like by using gill nets (Anon, 1984).

#### **1.4. The Indian context**

The gill net fisheries of India are described as one of the mainstays of the artisanal as well as small-mechanised sectors of the fishing Industry. In the commercial sense the gill net fishery of the country comprised of small scale localised operations as no modern techniques and large scale capital expenditure are applied to catch, store and process the fish on board the fishing boat or at the landing

centres (Nielsen and Lackey, 1980). Oceanic gill netting as a commercial enterprise is not in vogue in the Indian EEZ. In the small scale sector, a variety of large mesh drift gill nets are operated by mechanised and non-mechanised craft targeting at the large pelagics in the offshore waters upto 100 m depth. Nets are seldom over 1.5 km in length and are operated on both east and west coasts generally within the 50 km isobath with a variety of mesh sizes (IPTP, 1990). George (in press) reported that large mesh drift gill nets are becoming popular in the off shore area and small mesh nets specific to the resources are becoming common in the coastal and inshore area.

Gill nets are the dominant type of gear at the all India level. They formed around 25 % of the total in 1988 (Anon, 1988). A majority of the 1 50 000 artisanal vessels as well as possibly 6 000 to 8 000 small mechanised vessels employ drift gill nets. The gill nets landed 2.9 to 3.5 lakh tonnes of marine fish accounting for 15 % of the total marine fish landings of the country during 1985-92 (Luther *et al.*, 1997). The large mesh gill nets contributing to about 11 % of the total marine fish landings accounted for 71 % of the total gill net landings. The small mesh gill nets contributed 29 % of the total gill net landings. Kerala landed the bulk (21 %) of the large mesh gill net catch of the country followed by Tamil Nadu (17 %), Gujarat (16 %),

Maharashtra and West Bengal (13 % each), Andhra Pradesh (11 %) and the rest (9 %) contributed by Karnataka, Goa and Orissa. In the small mesh gill net sector, Tamil Nadu landed maximum (41 %), followed by Andhra Pradesh (27 %), Kerala (12 %) and 20 % contributed by Gujarat, Maharashtra, , Karnataka, Orissa and West Bengal.

Gill nets form 66 % of all fishing methods of Kerala as out of the 55 712 artisanal gears operated in Kerala, 36 552 units are gill nets (SIFFS, 1999). It contributed 9.2 % of the total marine fish catch of the state during 1993-96 (Yohannan *et al.*, 1999). Suseelan and Rajan (1993) reported that gill nets landed 37.6 % of the prawn catch of Kerala during 1985-89.

### **1.5 Review of Literature**

Many aspects of gill nets were studied in different parts of the world. Studies were related to classification, description of the fishing system, selection of material, selectivity aspects and catch efficiency.

Chernphol (1951), Davis (1958), Klust (1959), Satyanarayana and Sadanandan (1962), Andreev (1962), Sainsbury (1971, 1996), Brandt (1959, 1984), SIFFS (1991, 1999) and Luther *et al.*, (1997) classified gill nets into different groups.

Munasinghe (1985) described the drift net fishery of Sri Lanka. Karlsen and Bjarnasson (1987) discussed on the advantages and disadvantages of drift net fishing. Northridge (1991) gave a worldwide review of the drift net. Description of the gill net fishing of different maritime states of India were made by many (Muthiah, 1982; George, 1971, 1981; Pillai *et al.*, 1991; Narayanappa *et al.*, 1993; Kemparaju, 1994; Sivadas, 1994; Koya and Vivekanandan, 1992 and Pravin *et al.*, 1998).

Description on the gill nets of Kerala was made by a few. Hornell (1938) described two typical gill nets of Malabar coast used for mackerel and sardine. Anon (1951) and Nayar (1958) gave a description of gill nets and their mode of operation. A detailed account of the design and construction of gill nets for sardine and mackerel was given by Satyanarayana and Sadanandan (1962). Silas *et al.*, (1984) discussed on the mechanised drift gill net fishery off Cochin during 1981 and 1982. Yohannan and Balasubramanian (1989) studied drift gill net fishery of Calicut with special reference to scombroids. Jayaprakash (1989) studied the trends in drift gill net fishery of Cochin with special reference to effort, inputs and returns during 1986-87 and compared the same with that of 1981 and 1982.



Vijayan *et al.*, (1993) studied the coastal gill nets of Kerala with changes taken place in three decades from 1958 to 1990.

The most important aspects of gill net construction, which affect its ability to fish, are hanging coefficient and rigging. The effect of hanging coefficient of the net on the catch efficiency was studied by many (Baranov, 1948; Riedel, 1963; Miyazaki, 1964; Ishida, 1969; Panikkar *et al.*, 1978; George, 1991 and Samaranayake *et al.*, 1997). The rigging of net depends on the target fish and local conditions. The headline height in water depends on the ratio of buoyant force to ballast (Fridman, 1986; Sainsbury, 1996). The approximate formulae for the moving speed of the net and the shape of net was worked out by Matuda and Sannomiya (1977 a, b and 1978). The head rope height and drag of bottom set gill nets in a flume tank and set across a water flow was measured by Stewart and Ferro (1985) and Matuda (1988). The useful net area decreases due to the sag between the floats (Fridman, 1986). Anon (1997) reported the use of floatropes (floats concealed in ropes) for better positioning of gill nets in water.

The selection of the best available material for a specific gear is very important (Klust, 1982; Karlsen, 1989). Nomura (1959), Nomura (1961), Mugas (1959), Molin (1959), Amano (1959), Zaucha

(1964), Shimozaki (1964), Carter and West (1964), Sulochanan *et al.*, (1968) and Mathai and George (1972) discussed the superiority of synthetics over natural fibres. Firth (1950) and Meenakumari *et al.*, (1993) reported that the major commercial use of polyamide (PA) is in the fabrication of gill nets. Shimozaki (1964), Carrothers, (1957), Lzarkins (1963), Honda and Osada (1964), Klust (1964), Steinberg (1964), Khan *et al.*, (1975), Shon, (1978), Nayar *et al.*, (1985), Radhalakshmi & Nayar (1985) and Njoku (1991) studied the comparative catching efficiency of monofilament and multifilament. The popularity of polyamide (PA) monofilament in gill nets was reported by Anon (1961), Vijayan *et al.*, (1993), Rao *et al.*, (1994), Pravin and Ramesan (2000) and Thomas and Hridayanathan (in press). Suitability of polypropylene (PP) for gill nets was studied by Carter and West (1964), Radhalakshmi (1989), Mohan Rajan *et al.*, (1991) and Khan *et al.*, (1993). Polyethylene (PE) is the cheapest synthetic material suitable for different types of fishing gear. Reports are available, suggesting the use of PE in gill nets targeted for large pelagic species (Pajot, 1980 a; Pajot and Das, 1984; Radhalakshmi & Nayar, 1985; and Pillai, 1989). Radhalakshmi *et al.*, (1993) suggested that PE yarn can be considered as an alternative material for PA in fine gill nets. Weathering resistance of different materials was studied

by many to assess the material performance (Egerton and Shah, 1968; Little and Parsons, 1967; Singleton *et al.*, 1965; Meenakumari and Ravindran, 1985; Meenakumari *et al.*, 1985; Meenakumari *et al.*, 1995 and Alsayes *et al.*, 1996).

The success of fishing also depends on the visibility of the net, which in effect depends on thickness, and type of material. The ratio of twine diameter to mesh size is of decisive importance and this relationship for many fishes were worked out by several researchers (Baranov, 1948, 1976; Fridman, 1973; Sulochanan *et al.*, 1975 and Mathai *et al.*, 1993).

Eventhough the awareness of the basic property of gill nets viz. 'selectivity' existed as early as in 19<sup>th</sup> century (Collins, 1882), its scientific study started later (Baranov, 1914). Baranov (1948) proposed the basic mathematical models for selectivity curves. Mc Combie and Fry (1960) and Regier and Robson (1966) described the underlying mathematics and associated application. Holt (1963) proposed an algebraic method of estimating complete selectivity curves. Hamley (1975) reviewed the studies on selectivity of gill nets. Discussions on gill net selectivity can also be found in Gulland and Harding (1961), Mc Combie (1961), Ishida (1962, 1964), Strzyzewski (1964), Kitahara (1971), Hamley and Regier (1973), Jensen (1986),

Dayaratne (1988), Mathai *et al.*, (1990), George (1991) Yatsu and Watanabe (1987), Vendeville (1990), Karunasinghe and Wijayaratne (1991), Reis and Pawson (1992), Blady *et al.*, (1994), Mattson (1994), Pet *et al.*, (1995), Acosta and Appledorn (1995), Psuty (1996), Psuty and Borowski, (1997), Erzini and Castro (1998), and Madsen *et al.*, (1999). Optimum mesh sizes for important commercial species of India were worked out by many (Joseph and Sebastian, 1964; Sreekrishna *et al.*, 1972; Sulochanan *et al.*, 1975; Panikkar *et al.*, 1978; Khan *et al.*, 1989; Mathai *et al.*, 1990; Kartha and Rao, 1991; George, 1991; Mathai *et al.*, 1993; Luther *et al.*, 1994 and Neethiselvan *et al.*, 2000).

Yater (1982) and Librero *et al.*, (1985) compared catch, cost structure and profitability of mechanised and non-mechanised gill net fishing units. Panayotou *et al.*, (1985) studied the cost structure and profitability of various combinations of fishing techniques. The economics of operation of gill nets in India was studied by many (Noble and Narayanan kutty, 1978; Kurien and Willmann, 1982; Silas *et al.*, 1984; Sehera and Kharbari, 1989; Panikkar *et al.*, 1990, 1993; Anon, 1991; Dutta and Dan, 1992; Iyer, 1993; Luther *et al.*, 1997 and Shibu, 1999).

Many workers have evaluated the productivity of different fishing inputs in gill net fishing systems, by comparison of the technical efficiency among fishing gears and fishing grounds (and their combinations), and by assessment of the economic efficiency of input use. The difference in catch can arise from 'inputs' such as size and power of crafts, size of nets, fishing effort in terms of crew and time and management skills of fishermen (Jayantha and Amarasinghe, 1998). Tokrishna *et al.*, (1985), Yater (1982) and Shibu (1999) applied fishery - production function by type of fishing gear including drift gill nets. Fredericks and Nair (1985) found that fuel consumption was the most significant explanatory variable across gears and locations, suggesting fishing time, horsepower, or both, as limiting factors on catch. Khaled (1985) compared the productivity of drift nets and seine nets in the riverine fishery of Bangladesh. Balan *et al.*, (1989) assessed the impact of motorisation on production, productivity and earnings of fishermen in the motorised, non-motorised and mechanised gill net sectors of Kerala.

## **1.6. Background of the study**

Kerala with 10 % of India's coastline and 7 % of India's continental shelf, produced around 23 % of the total marine catch in 1998 and accounted for 23 % of the country's seafood exports

(Anon, 1999). The target for fish production during the 9<sup>th</sup> five year plan is 7.5 lakh tonnes which include 6 lakh tonnes under the marine sector and 1.5 lakh tonnes under the inland sector, while the production for 1998 was 5.48 lakh tonnes of marine fish and 0.66 lakh tonnes of inland fish (Anon, 1999). This point out that the marine sector has already reached saturation level.

The symptoms of excess fishing effort and its consequences were felt in the Kerala fishing sector (Achari, 1993). The number of boats increased to 10 times the number required for catching the available fishery resources. There are 4 040 mechanised craft, 27 094 motorised craft and 21 598 non-motorised craft operating in Kerala waters as per the figures for 1998-99 (Anon, 1999). This shows an increase from 34 007 in 1988-89 to 52 732 in 1998-99 viz., 55 % increase in 10-year period. Kurup and Devaraj (2000) estimated that the state is having 982 mechanised craft, 21 037 motorised craft and 16 801 non-mechanised craft in excess of its actual requirement. As per the 1980 estimate itself, for every 100 km of inshore waters 233 fishing craft were operated against 89 for the rest of the country. The increased fishing effort resulted in overfishing (George *et al.*, 1980; Rao *et al.*, 1980). Trawls dominate the marine fisheries in the mechanised sector and ring seines in the artisanal sector of Kerala.

The deleterious effects on the resources by ring seines are reported (Thomas and Hridayanathan, 1998; Yohannan et al., 1999 and Thomas, 2000). These gears sidelined other gears such as gill nets (Yohannan *et al.*, 1999). Contribution of gill nets to the total marine fish landings of the state decreased from 15.5 % in 1984 to 7.4 % in 1992 while the contribution from ring seines, introduced in 1986, increased from 5.8 % in 1986 to 35 % in 1992 (Alagaraja *et al.*, 1994).

Gill nets are the most commonly used gear in all the districts of the state depended upon by the maximum fishermen. Out of the 1.71 lakh sea going fishermen of the state (Anon, 1996), 78 222 operate gill nets. The fact that 45.74 % of the sea going fishermen depended on this gear is very significant. The studies concentrating on this selective fishing method depended upon by the maximum fishermen of the state, have become highly essential.

Eventhough isolated studies were carried out on the aspects like description of the gear, optimum mesh size for certain commercially important fishes and economics of operation of gill net units of Kerala, a comprehensive study addressing important technological and operational aspects with attempts to optimisation has not been taken up so far. Therefore the present study was taken

up which identifies the types of nets available, their technical characteristics, material aspects, selectivity and techno-economic efficiency of operation.

### 1.7. Scope and Objectives

The study would provide a picture on the present scenario of gill net fishing in Kerala. The selectivity aspects would help in fixing minimum mesh size for exploiting different species and examine the suitability of gill nets as a selective gear in exploiting a multispecies inshore fishery. The study would also help in identifying suitable material for replacing costly polyamide which help in reducing the cost of production. The outcome of the study would provide a comparison between the production and income levels of fishermen under different sectors and would throw light on whether motorisation benefited the fishery and the fishermen.

The study has the following main objectives

- 1) To classify, describe and scientifically document gill net types of Kerala considering their regional variation in the design.
- 2) To study the mesh selectivity for *Sardinella longiceps*, *Otolithes argenteus* and *Penaeus indicus*



- 3) To examine the role of small mesh gill nets in the exploitation and conservation of inshore fishery resources
- 4) To examine the scope of substituting polyamide multifilament with polyethylene twisted monofilament in seer gill nets
- 5) To compare the relative technical and economic efficiency of the non-motorised, motorised and mechanised gill net fishing sectors.

## **Chapter 2**

# **Materials and Methods**

## **Chapter 2.**

### **MATERIALS AND METHODS**

The present study on gill nets covers aspects such as technical specifications and selectivity of gear, properties of gear materials and techno- economic performance of the different gill net systems.

#### **2.1. Data Base**

The study required data of primary and secondary nature. While secondary data of a direct nature is scanty, there is need to depend extensively on primary data. The primary data mainly relate to two categories: (i) data on laboratory and field experiments; and (ii) data on techno-economic aspects (capital investment, effort and productivity).

There are several secondary data sources, which provide information related to the problem. Publications/data base of research organisations, administrative departments and non-governmental organisations constituted such sources. The Central Marine Fisheries Research Institute, The Central Institute of Fisheries Technology, Directorate of Fisheries (Kerala), South Indian Federation of Fishermen Societies (SIFFS), offices of the apex body of the Kerala

Fishermen's Co-operative Federation (Matsyafed) and Fishermen Welfare Cooperative Societies were the important agencies from where data were collected. The information gathered was used to work out a more detailed sampling procedure.

## **2.2. Base Line Survey**

The SIFFS (1991) has provided preliminary information into the distribution of gear and craft along the Kerala coast, which served as the preliminary material for the present study. Thus, based on the indication given by SIFFS and other related records (Anon, 1981; 1996) a base level survey was conducted. As this survey was intended to provide information on the net types available in the entire state, sixteen centres representing seven districts from the three regions of the state viz. south, central and north (Kurien and Willmann, 1982) were selected. The location map of the centres surveyed is given in Fig. 2.1. The technical specifications of craft, design details of the gear, ownership and investment, sharing pattern and mode of operation were recorded from randomly selected fishing units. This was carried out following Miyamoto (1962). Based on the information gathered from the survey, the gill net types of the state were classified based on mesh size. The level of technology with respect to craft was considered as the basis for the second stage

sampling while 'species targeted' formed the basis of the third stage of the sampling. Thus the gill nets of the state were classified primarily into 'small mesh' and 'large mesh' and further into three subsectors: 'non-motorised, motorised and mechanised'. Based on species targeted nets were classified into twelve groups.

### **2.3. Research Sites**

For the detailed study on technical and economic efficiency aspects, five landing centres representing each subsector were selected from three districts viz. Alappuzha, Ernakulam and Thrissur. These districts constituting the central part of Kerala as identified by Kurien and Willmann (1982) were selected as they had representation of all the three subsectors viz. non-motorised, motorised and mechanised gill nets.

**Alappuzha:** Motorised sector using large mesh nets is concentrated in centres like Chettikadu and Arthinkal in Alappuzha. Chettikadu with a concentration of 40.9 % of the district's large-mesh drift nets (SIFFS, 1991), was selected to study the motorised large-mesh gill net units targeted for seer and tuna.

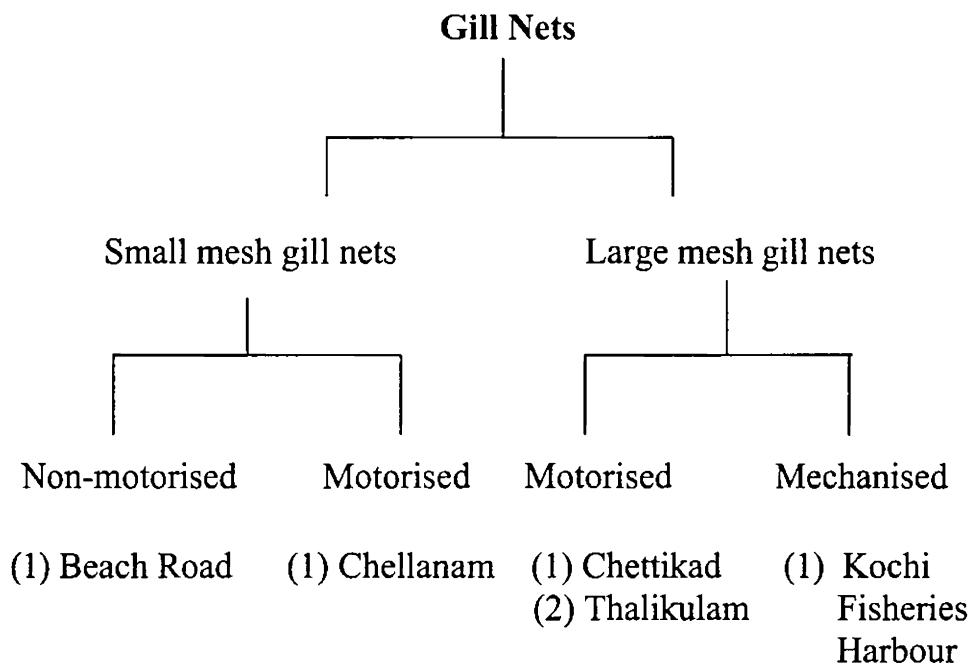
**Ernakulam:** The gill net sector of the district is represented by small non-motorised canoes, medium sized motorised canoes and

mechanised boats. Beach road landing centre at Kannamaly was selected for studying the non-motorised small mesh gill nets; as 13.8 % of the district's exclusively sea-going non-motorised gill net units operate from here. Motorised mackerel gill net units of Chellanam were selected as they represent 16.5 % of the districts motorised small mesh gill net sector (SIFFS, 1991).

Kochi fisheries harbour was selected to study the mechanised large mesh sector as this premier fish landing centre of Kerala, accommodates 82 % mechanised gill netters of the state.

**Thrissur:** Presently, the gill net sector of Thrissur is mainly characterized by the plywood boat sector operating large mesh gill nets concentrated mainly at Thalikulam and Blangad. Thalikulam, where 48.9 % of the units are concentrated (SIFFS, 1991), was selected as the second centre for studying the motorised large mesh gill nets.

The sample frame presented below represents the centres selected under each category.



## 2.4. Sampling

The basic sampling unit of the study was the fishing unit. The total number units to be selected was fixed as 45 considering the manageability to monitor the units individually throughout the study period. The sample units were selected by random sampling. However choice was governed also by such consideration as the reliability of the data to be collected during the course of the study. A detailed sample frame is depicted in Table 2.1.

## **2.5. Data Collection and Analysis**

### **2.5.1. Experimental Aspects**

The experimental aspects of this study relate to three aspects: (i) Photodegradation of gill net materials due to weathering; (ii) material substitution; and (iii) selectivity.

#### **2.5.1.1. Photodegradation of Gill Net Materials:**

The effect of sunlight on the mechanical strength properties of gill net materials viz., Polyamide (PA) monofilament, PA multifilament, and high density polyethylene (HDPE) twisted monofilament were assessed by exposing samples to sunlight for a period of 180 days and measuring the loss in mechanical strength as well as analysing the degradation of polymer structure by infrared (IR) spectroscopy.

**Loss in Mechanical Strength:** Representative sub-samples drawn from sunlight exposed samples at intervals of 6, 12, 24, 48, 90, 120, 150 and 180 days were tested for loss in breaking strength and extension against exposure time. Tests were carried out with a Universal Testing Machine of ZWICK model 1484, in accordance with IS: 5815 (Part IV): 1971. The loss in strength in terms of original was calculated, since the material loses its serviceability



when 50 % reduction occurs in its original strength (Brandt, 1959). Analysis of variance (ANOVA) technique as per Snedecor and Cochran (1956) was used in analysing the significance of observations.

**Assessment of Degradation by IR Spectroscopy:** The degradation of polymer structure by extensive service (exposure to weather) was assessed by infrared spectroscopy. The samples after outdoor exposure were analysed along with unexposed samples using Fourier Transform Infrared (FTIR) spectrometer of model Nicolet Avatar 360 ESP.

#### **2.5.1.2. Material Substitution in Seer Gill Nets**

The substitution of PA multifilament in seer gill nets by PE twisted monofilament was tried, by selecting PE of 1.25 mm dia (Rtex 620). Experimental net of PE of dimensions identical to the commercial standard gear of PA 210 x 6x3 (R455 tex) was designed, fabricated and operated from a motorised plywood canoe based at Chettikadu, Alappuzha, along with the commercial PA nets for comparison. Sixty-five operations were carried out during August 1999 and May 2000.

Catch from each net was sorted into species and the number of fishes in each net, length (total length) to the nearest cm and weight to the nearest 100 gram were recorded. Durability of each net and the manpower requirement for operating each net were assessed based on Zaucha (1964). The economic efficiency of the experimental net over the standard net was assessed by the index of economic efficiency (Fridman, 1986).

### **2.5.1.3. Selectivity**

#### **2.5.1.3.1. Selectivity estimates for *Sardinella longiceps*, *Otolithes argenteus* and *Penaeus indicus*.**

*S. longiceps*, *O. argenteus* and *P. indicus* caught in PA monofilament gill nets of mesh sizes 32, 34, 36, 38, 40 and 50 mm were sampled for a period of 12 months at the fish-landing centre at Beach road, Kannamaly. The 'total length' of individual fish was measured to the nearest mm (Sparre *et al.*, 1989). The selectivity was estimated by indirect method (Holt, 1963).

#### **2.5.1.3.2. Catch Analysis**

Catch analysis of small mesh gill nets with special reference to juveniles formed another aspect of the study. Species and size composition of the catch were assessed for the small mesh gill net

sector. The site of investigation was Beach road landing centre at Kannamaly. The field data collection covered once a week, for a period of two years, from March 1998 to February 2000. The mesh size of gear used on the particular day was measured. The data on species wise and total catch from fishing units were collected as per Alagaraja (1984). Identification of the species was made following Fischer and Bianchi (1984).

The data analyses included calculation of length frequency of major group of fishes and comparison of the length frequency against the size at first maturity available from published records. Specimens with total length below the size at first maturity were considered as juveniles.

## **2.5.2. Technical Specification of Nets**

### **2.5.2.1. Design and Technical Details**

The information on the design, and dimensions of the gear were recorded for all gill net types from each of the centre during the base line survey following Miyamoto (1962). The design of the gear was documented following (Nedelec, 1975). The physical dimensions of the craft, horsepower of the engine, sharing system, mode of operation and fishing season were also documented.

### 2.5.2.2. Presentation of Design Drawings

The design details of the nets are prepared and presented as per FAO Catalogue of Fishing Gear Designs (Nedelec, 1975). The design drawings of the nets are not to scale. The dimensions of the net (length and width) are denoted by the number of meshes along the edges of the straight line representing length and width of the net.

The international system of nomenclature for netting yarns is tex (1000 m of a single yarn weighing 1 g = 1 tex). The material is designated as tex in the design drawings and where the particular material is described for the first time in the text. Since denier (9000 m of a single yarn weighing 1g = 1 denier) and diameter are the common designations followed for multifilament and monofilament respectively, these are used frequently in the text and tables.

Metric system is followed, metre (m) and millimetre (mm) are used for length, width, thickness and diameter. For designating length of ropes and dimensions of net (length and depth) 'm' is used, but for stretched mesh size, diameter of ropes and dimensions of floats 'mm' is used. Weight is given in kilogram (kg) and gram (g).

The hanging coefficient (the ratio of the length of the rope to the stretched length of the netting) denoted as E or E1 is given as

decimal figure. The fishing height or hung depth is the theoretical depth.

The symbols used are explained below

~ = Approximately

Ø = diameter

◇ = Mesh

### **2.5.3. Techno-economic Aspects**

Two pre-tested interview schedules: schedule I and II were used for collecting the investment and operational details of the selected fishing units. Schedule I was used to gather information relating to the dimensions of the gear, capital investment and other fixed overheads of the unit. This information was collected only once at the initial stage of the study. Schedule II was used on a weekly basis to collect the operational cost and revenue from each of the unit for two successive years viz., from May 1998 to April 2000. Data were collected by direct observation and by interviewing the fishermen during weekly visits to the landing centres. Discussions also were made with the operators of the units and with commission agents/middlemen to verify and ascertain the validity of the data. The

technical efficiency of the different gill net sub-sectors were compared using standard indicators such as effort, productivity and energy efficiency. The economic performance of the systems was assessed using analytical techniques such as, return on investment (ROI), internal rate of return (IRR), sensitivity analysis, payback period and factor productivity.

Detailed methodology is given in the respective chapters.

**Table 2.1. Distribution of samples selected**

Centre	District	Gill net category			
		NM-SM	M-SM	M-LM	MC-LM
Beach road	Ernakulam	14 (35*)	-	-	-
Chellanam	Ernakulam		9 (26.4)	-	-
Chettikad	Alappuzha	-	-	7 (14)	-
Thalikulam	Thrissur	-	-	5 (21.7)	-
Kohi Fisheries Harbour	Ernakulam	-	-	-	10 (2.8)
	Total	14	9	12	10

NM-SM : non-motorised small mesh

M-SM: motorised small mesh

M-LM : motorised large mesh

MC-LM : mechanised large mesh

\*Figures in brackets refer to percentage selected to the total population

# KERALA

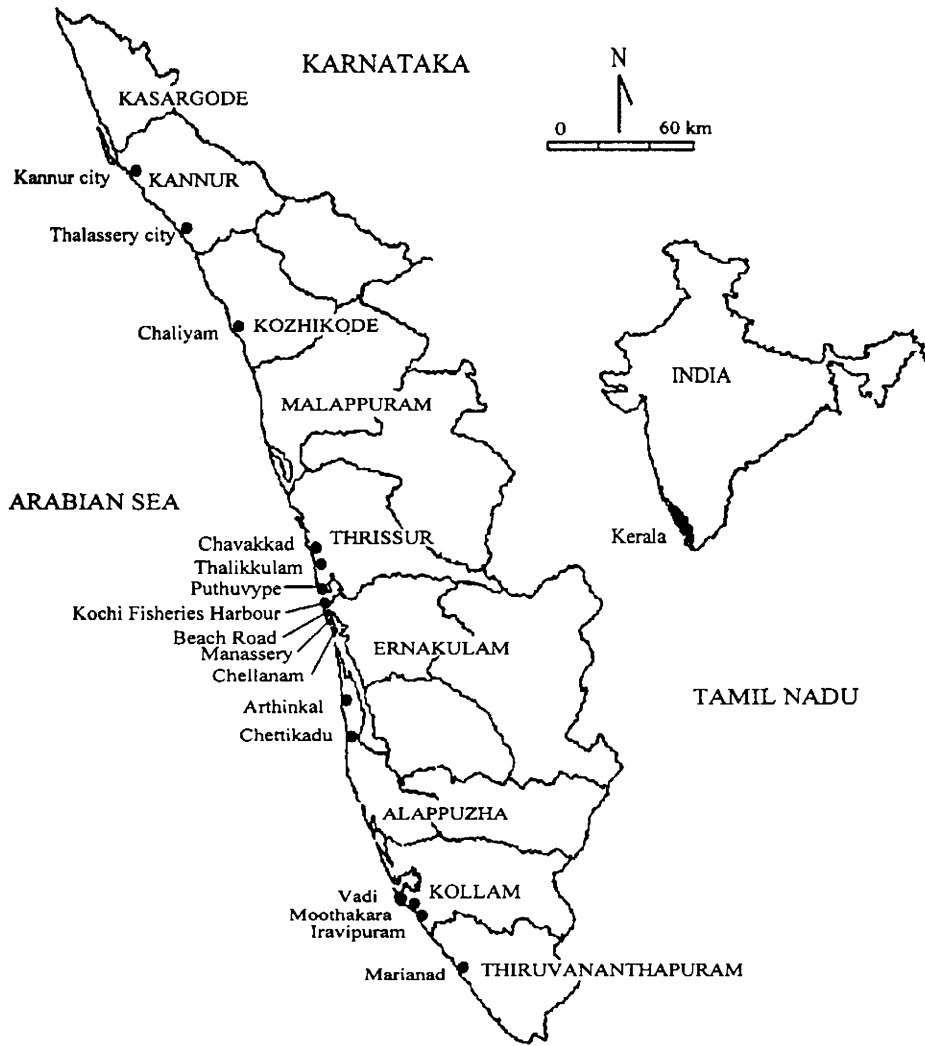


Fig. 2.1. Map of Kerala showing location of centres



## **Chapter 3**

# **Design and Technical Characteristics**

## Chapter 3

### DESIGN AND TECHNICAL CHARACTERISTICS

This chapter is divided into two sections. The first section describes the different gill nets of Kerala with reference to design and technical characteristics and their regional variations. The operational aspects also are covered in this section. In the second section, an examination of the design of the gill net types is carried out with specific focus on twine size-mesh size relationship, hanging coefficient, buoyancy-weight relationship and distribution of floats.

#### *SECTION 1*

##### 3.1. CLASSIFICATION AND DESCRIPTION OF NETS

###### 3.1.1. Introduction

Regional distribution of any fishing gear depends on topography and resource availability of the area. A thorough knowledge of the existing gear is highly essential for further improvement and possible development. Documentation of the changes that have taken place from time to time is important factor for evolving a new gear. Description of any gear needs to cover aspects such as material, design and operation. Classification of the

gear is a prelude to its description. Several workers attempted classification of fishing gear but most of them limited it to alphabetical listing of names or description of gear (Davis, 1927; Umali, 1957 and Burdon, 1952). Baranov (1933) was the first to provide a scientific classification of fishing gear. Brandt (1984) suggested that the basis for classification of fishing gear is the principle involved in fish capture. However, based on factors such as material, construction and method of operation also, classification of fishing gear can be made.

Chernphol (1951) and Davis (1958) classified gill nets into two: fixed instruments and movable instruments or drift nets. Miyamoto (1956) and Brandt (1984) broadly classified gillnets into gilling and entangling types. Klust (1959) based on the stress and strain developed on the gear while under fishing, grouped fine gill nets under 'low strain' and drift nets under 'medium strain' fishing gear. Sainsbury (1971) included gill nets under static gear.

Attempts were also made by some to classify the fishing gear of India. George (1971) classified the inland fishing gear into nine classes with gill nets as a single class. Luther *et al.*, (1997) grouped gill nets into different categories based on (i) mode of operation, and (ii) mesh size.

Though various types of indigenous fishing gear of Kerala were reported (Hornell, 1938; Bal and Banerji, 1951; Anon, 1951; Kurien and Sebastian, 1976 and Menon, 1980), classification and description of gill nets in particular were made by a few. Hornell (1938) in his account on the fishing methods of Malabar coast included the description of only two typical gill nets of the area, viz., for mackerel and sardine. Satyanarayana and Sadanandan (1962) suggested a classification of gill nets and gave detailed accounts of the design and construction of gill nets for sardine and mackerel. SIFFS (1991) classified gill nets as very small, small, medium and large, based on the weight of net carried onboard the vessel for operation.

In all these accounts the technical details on design are either lacking or are limited to a few types. No systematic attempt has been carried out so far to classify gill nets of Kerala and to discuss the design aspects. In view of this, an attempt was made with the following objectives.

- i) to classify the gill nets of Kerala
- ii) to document the design and technical specifications of gill net types;

- iii) to study the regional variations in the design; and
- iv) to study the changes that have occurred in the gear during the past four decades.

### **3.1.2. Materials and Methods**

A survey of the entire coast of Kerala was carried out with reference to gill nets in operation. The census carried out on the artisanal marine fishing craft and gear of Kerala by SIFFS (1991) provided information on centres where there is concentration of gears. Anon (1981) and Anon (1996) also were used for identification of centres.

Informal discussions were made with the fishermen to know the design characteristics of gear peculiar to each region as well as changes occurred from time to time in the past few decades. The base level informal survey was conducted at sixteen centres as detailed in Chapter 2 (Fig. 2.1). The gear survey was conducted following Miyamoto (1962). The technical specifications and design details of the gear and mode of operation were recorded. The design of the gear was documented following Nedelec (1975).

### **3.1.3. Results and Discussion**

Based on the information gathered during the survey, the gill net types of the state are classified and taking each resource specific gear, the technological details are described.

#### **3.1.3.1. Classification of Gill Nets**

Based on mesh size, the gill nets are broadly classified into two: small mesh and large mesh gill nets. Gill nets with stretched mesh size less than 70 mm are grouped under 'small mesh' and those with mesh size above 70 mm under 'large mesh'. Subsequent classification into drift and set nets is made based on the mode of operation. Further, the nets were classified based on the target fish. A schematic representation of the classification is given in Fig. 3.1. The figure showed that most of the gill nets are of the drifting type except lobster and shark nets, which are operated as set nets. Shark nets are operated both as drift and set in different centres. The encircling nets were completely absent probably due to introduction of efficient nets like ring seines for shoaling fishes. Luther *et al.*, (1997) grouped gill nets of India into small mesh and large mesh keeping 45 mm as the cut off mesh size. From the length frequency data collected during the present study it is observed that most of the

fishes caught in mesh size below 70 mm grew upto a maximum size of 30 cm only. Hence in the present study 70 mm was selected as the cut off mesh size considering the size of the target group.

The mode of operation of gill nets has changed from encircling to drifting type and the emphasis today is more on resource specific gear. Hence this classification is suggested based mainly on mesh size and target species.

### **3.1.3.2. Design and Technical Specifications**

#### **3.1.3.2.1. Mackerel gill nets**

Mackerel gill nets are operated as drifting gear in the bottom or column waters unlike in 1950s and 60s when encircling was the mode of operation. Mackerel fishery commenced with periodic large-scale movement of the mackerel shoals from the offshore to the inshore waters (Bal and Rao, 1984). The technical and design details of 'aila chalavala', the encircling gill net for mackerel was detailed by Satyanarayana and Sadanandan (1962). Hornell (1938) described chalavala of the Malabar coast used for mackerel. Vijayan *et al.*, (1993) reported various changes which have taken place from 1958 to 1991 in the craft, gear material, dimensions of the gear, and depth of operation.

The present study indicated that mackerel gill nets are widely used all along Kerala coast. In all the other centres surveyed, this net was in operation as drifting type either from motorised or non-motorised vessels. Design of a typical mackerel gill net operated in Chellanam area of Ernakulam coast is given in Fig. 3.2. Regional variations were found in certain aspects such as mesh size, dimension (length and depth) and depth of operation. (Table 3.1).

The 'echavala' prevalent at Kollam and Thiruvananthapuram coasts targeted for mackerel and small tuna had a slightly varying construction. The catching mechanism is more by entangling as the nets rigged more loosely were devoid of footrope and sinkers unlike mackerel gill nets of other centres.

**Material:** In all the centres surveyed except Kollam and Thiruvananthapuram coasts, the mackerel gill nets were exclusively of PA monofilament of dia 0.16 mm (Tex 23), 0.20 mm (Tex 44) and 0.23 mm (Tex 50). At Kollam and Thiruvananthapuram coasts, PA multifilament of 210dx1x2 (Rtex 51) and 210dx1x3 (Rtex 76) are used.

**Mesh size:** Mesh sizes ranged between 40 to 60 mm but 50 to 54 mm were common. The 40 mm was targeted for small sized mackerel in



the inshore waters and the 58 to 60 mm for small tuna also. Satyanarayana and Sadanandan (1962) reported almost uniform mesh size of 50.8 mm and Vijayan *et al.*, (1993) reported 50 mm in 1958 and 50 to 52 mm in 1991 for mackerel. Mathai *et al.*, (1993) conducted mesh selectivity studies in mackerel gill nets operated off Goa and found that a mesh size of 50 mm was optimum for the exploitation of mackerel of commercially accepted size having a total length of 190-200 mm.

**Hanging coefficient:** The hanging coefficient of the net ranged between 0.43 and 0.64. The 'echa vala' of Kollam and Thiruvananthapuram, meant for catching fish by entangling had hanging coefficient ranging between 0.43 to 0.44 but nets at other centres had hanging coefficient between 0.52 to 0.64.

**Hung depth:** The hung depth or fishing height of the net ranged between 4.0 to 12.8 m; those operated from non-motorised vessels had hung depth ranging between 4.0 to 5.5 m and those from motorised vessels from 4.1 to 12.8 m.

Mackerel gill nets of the late 1950s had a depth of 9 to 18.9 m for the encircling operation (Vijayan *et al.*, 1993). Mackerel fishing was generally carried out in neritic waters upto a depth of 25 m as the

major area of distribution was within 25 m of water depth with occasional catch by trawlers from much greater depths (Bal and Rao, 1984). Fishing height rather than the fleet length of drift nets was regarded as a factor of importance for efficient fishing. Bottom drift nets usually had less height compared to midwater and surface nets.

**Fleet length:** The fleet length varied in the different regions (Table 3.1). The length taken onboard non-motorised vessel was in the range of 320 to 510 m and on motorised vessel was 650 to 1040 m. The number and size of drift gill nets for small-scale fisheries were normally restricted by the financial condition of the operator and space on board the vessel.

**Depth of operation:** The depth of operation of mackerel gill nets ranged from 4.8 to 64 m. In the motorised sector this was from 16 to 64 m and in the non-motorised sector it was from 4.8 to 11.2 m. This is a clear indication that motorisation helped fishermen to exploit deep and distant waters. However, there was not much change in the depth of operation compared to early 1990s as Vijayan *et al.*, (1993) reported that non-motorised vessels operated at a depth of 4.7 to 6.7 m whereas motorised vessels at 15 to 100 m.

### 3.1.3.2.2. Sardine Gill Nets

Hornell (1938) described the general dimensions of the 'mathi chala vala' of Malabar coast for sardines. Joseph and Sebastian (1964) studied the effect of mesh size on the fishing efficiency of sardine gill nets. Satyanarayana and Sadanandan (1962) described sardine gill nets of Kerala coast with a detailed account of a net of mesh size 38.0 mm. Vijayan *et al.*, (1993) gave an account of the sardine gill nets of Kerala during 1991 in comparison to those of 1958.

The present investigation indicates that gill nets for sardine are distributed through out Kerala coast and are operated both from motorised and non-motorised vessels. Sardine gill nets of 1950s and 60s were of encircling type, but presently it is of the drifting type. Design details collected from the centres were analysed and the design of a typical net operated at Beach road, Ernakulam is given in Fig. 3.3. Regional variations observed are furnished in Table 3.2. The important aspects such as material, mesh size, fishing height and depth of operation in which regional variations were noticed are discussed below.

**Material:** In all the centres surveyed except Kollam coast, the sardine gill nets were exclusively of PA monofilament of dia 0.16 mm and 0.20 mm. At Kollam, PA multifilament of 210dx1x2 was prevalent. The rocky seabed and vast stretches of open beaches where there was no facility for protection of the net from direct heat of sun prevented the fishermen from using PA monofilament (personal communication).

**Mesh size:** Mesh size ranged between 30 and 40 mm but mostly between 36 and 40 mm. Joseph and Sebastian (1964) found mesh size of 33.4 mm as most suitable compared to 28.0, 38.6 and 41.8 mm for the exploitation of sardine of 120-200 mm total length. Vijayan *et al.*, (1993) reported 32 to 42 mm mesh sizes for sardine gill nets in different centres. Unlike earlier days occurrence of large shoals of sardines in the near shore waters is rare and often a multitude of species are caught in sardine gill nets. To facilitate the capture of different species in different size groups, fishermen often use mesh size of 34, 36, and 38 mm in a fleet.

**Hanging coefficient:** The hanging coefficient ranged between 0.53 to 0.70. In general, webbing was rigged in such a way that there was scope for gilling and entangling. Satyanarayana and Sadanandan (1962) reported hanging coefficient of 0.46 to 0.56 for sardine gill

nets of the encircling type of the 1960s. Thomas (1964) suggested a hanging ratio of 0.50 and above suitable for gilling and entangling of the varying size and type of the tropical fish.

**Hung Depth:** Hung depth varied between 3.25 and 7.89 m. (Table 3.2). The variations depend on the locality and also the area of operation. Non-motorised units used nets of depth 3.25 to 5.87 m only whereas in motorised units depth ranged from 3.91 to 7.89 m. In general, compared to mackerel gill nets, sardine gill nets had a less fishing height probably due to the nearness of the fishing ground and hence the area of operation of this net is restricted. Fishing height of encircling sardine gill nets of the 1930s, 50s and 60s were reported as 3.68 to 5.25 m, by Hornell (1938), 4.65 to 5.94 m by Vijayan *et al.*, (1993) and 6.0 to 10.6 m by Satyanarayana and Sadanandan (1962) respectively. Vijayan *et al.*, (1993) reported a fishing height of 3.4 to 9.5 m in 1991 for drifting type sardine gill nets.

**Fleet length:** The total fleet length of the net ranged between 380 m and 1000 m in different centres. The difference depended on the type of vessel and method of propulsion. Non-mototrised vessels carried nets of total length 380 to 800 m and motorised vessels 480 m to 1000 m length. In the case of sardine gill nets, often the carrying capacity of the vessel was not fully utilized as a reasonable quantity

of small size fishes, if not sardines, the target group, would be caught in any case and the removal of these small fishes take a longer time compared to the large sized fishes. Hence the fishermen did not prefer carrying sardine gill nets to the full capacity of the vessel.

The volume of net used when vegetable fibres were in use was in the range 76 to 280 m (Vijayan et al., 1993; Satyanarayana and Sadanandan, 1962). By 1990, the quantity operated by non-motorised sector was in the range 193 to 400 m, the material being PA multifilament. The present data showed that the quantity of net operated even by non-motorised sector was further increased upto 1000 m probably due to the switch over of the material to PA monofilament.

**Depth of operation:** Depth of operation of non-motorised vessels ranged between 3.2 and 32 m and that of motorised vessels ranged between 16 and 64 m. Unlike mackerel gill nets, the depth of operation of sardine gill nets was restricted to a maximum of 30 m in most cases except Kollam and Thiruvananthapuram coasts where the depth was upto 64 m.

G, 82 28

### 3.1.3.2.3. White Sardine Gill Nets (Chooda vala)

Gill nets for white sardine was not reported in the records prior to 1990s. Vijayan *et al.*, (1993), mentioned gill nets for white sardine (*Kovala coval*) in the northern parts of Kerala. The present study indicates that this gear is concentrated along the northern Kerala coast under the name 'chooda vala' and 'veloori vala' with a multitude of mesh sizes ranging from 16 to 26 mm. Design of a typical white sardine net in operation at Kannur city, Kannur district is depicted in figure 3.4. Variations noticed in other centres are detailed in Table. 3.3. Essential aspects are discussed below.

**Material:** The material used in all the centres is PA multifilament of 210dx1x2. Vijayan *et al.*, (1993) also mentioned 210dx1x2 as the gear material used for white sardine gill nets of Kasargode area in 1991.

**Mesh size:** Mesh sizes in use are 16, 18, 20, 22, 24 and 26 mm but mostly 24 and 26 mm. The mesh size reported in 1991 by Vijayan *et al.*, (1993) was 24 mm.

**Hanging coefficient:** Hanging coefficient of veloori gill nets of all the centres is between 0.58 and 0.63. As the species is caught mostly

gilled and wedged, the nets are rigged with a hanging coefficient of around 0.60 for a better mesh opening.

**Hung depth:** Hung depth of the gear operated from motorised vessels varied from 2.87 to 8.20 m. Vijayan *et al.*, (1993) reported a hung depth of only 2.0 m for the veloori nets operated by the non-motorised vessels in 1991.

**Fleet length:** Generally nets of 420 to 800 m length are taken for operation by the motorised units. Vijayan *et al.*, (1993) reported 350 m as the fleet length operated by the non-motorised vessels.

**Depth of operation:** Much variation was not observed with regard to the depth of operation of nets operated from non-motorised vessels in 1991 and from motorised vessels presently. The depth of operation of nets operated from non-motorised vessels ranged between 5 and 10 m whereas that from motorised vessels ranged between 6 to 10 m. This was due to the nearness of the fishing ground.

#### **3.1.3.2.4. Anchovy Gill Nets**

Popularly known as 'natholi vala', these nets were popular in Thiruvananthapuram coast since 1958. Except the change in material from cotton to PA and increase in depth of operation from 10-14 m to 20-25 m much changes did not occur by 1991 as reported by Vijayan



*et al.*, (1993). The present study also indicates that this gear is confined to Kollam and Thiruvananthapuram coasts only. The probable reason is the presence of ring seine for anchovies (known as chooda vala) in other areas of the state.

Design details of a typical net operated at Iravipuram, Kollam is depicted in Fig. 3.5. Essential technical specifications are detailed in Table 3.4. Net has a mesh size of 14 mm, hanging coefficient of 0.55 to 0.56 and fishing height ranging between 7.29 and 7.39 m. Not much variations were noticed between the nets of the two centres and hence regional variation is not discussed here. The important aspects in which major changes have taken place from those of 1950s are discussed below. The material has changed from cotton to PA multifilament 210dx1x2 and mesh size from 15 mm to 14 mm. Fishing height of the net is almost double the height of the nets used in 1958 (Vijayan *et al.*, 1993). Depth of operation ranged between 1.6 to 3.2 m. Fishing season coincided with the start of southwest monsoon in May and continued for five months.

#### **3.1.3.2.5. Mullet Gill Nets (Malan Vala)**

This gear popularly known as 'malan vala' is a recent addition to the gill net fishing. Vijayan *et al.*, (1993) mentioned that this was not in vogue in 1958 and was a later addition.

The design of a typical mullet net is depicted in Fig. 3. 6. As the net is confined to a limited area, regional variations are not discussed. Important technical details are given in Table.3.5. PA monofilament of 0.16 mm is the material used. The mesh size varies from 30 to 36 mm and the net is strictly operated as a surface drift net with the floatline always touching the surface. The fleet length increased from 64-300 m in 1991 to 320-800 m presently. This is operated from non-motorised vessels almost round the year except during monsoon. However, the target group of fishes is available mainly during August to October.

#### **3.1.3.2.6. Prawn Gill Nets (Chemmeen Vala)**

Prawn gill nets along the Kerala coast was reported as early as in 1970s by Kurien and Sebastian (1976) and George and Brandt (1975). The monsoon ban on trawling and the escalation of fuel prices made gill netting for prawns more attractive. Suseelan and Rajan (1993) reported that gill nets landed 37.6 % of the prawn catch of Kerala during 1985-89.

The present investigation indicated that gill nets were increasingly used in many centres especially in Ernakulam coast. The design of a typical net operated at Beach road, Kannamaly is depicted

in Fig. 3.7. The technical specifications are detailed in Table 3.6. The material is exclusively of PA monofilament of 0.16 and 0.20 mm dia. Mesh sizes currently used are 34, 36, 38, 50 and 52 mm. The hanging coefficient is 0.53. The depth of operation ranges between 3.2 and 11.2 m and fleet length varies from 480 to 640 m.

#### **3.1.3.2.7. Lactarius Gill Nets (Parava Vala)**

Popularly known as 'parava vala' and 'edakettu vala' this net operated along Kollam-Thiruvananthapuram coast is targeted at parava (*Lactarius lactarius*). This net has not been reported earlier. The design of a typical net is given in Fig. 3.8 and the essential technical details are given in Table 3.7. The mesh size varied between 33 and 35 mm. PA multifilament 210dx1x2 formed the material of the net. The nets were hung with hanging coefficient 0.71 providing more mesh opening. The operation was carried out from marine plywood boat. The net had a depth of 5.14 m and the fleet length upto 600 m.

#### **3.1.3.2.8. Polynemus Gill Nets (Vazhmeen vala)**

The fishermen along Ernakulam coast was extensively using gill nets of mesh size 65 mm for the capture of polynemids. Popularly known as 'vazhmeen vala' this net was operated by traditional

fishermen from non-motorised boats. Design of a typical net is given in Fig. 3.9. Technical specifications are detailed in table 3.8.

The net operated as column drift had a mesh size of 65 mm and the material used was PA monofilament of 0.20 mm diameter, rigged at a hanging coefficient of 0.54. It had a depth of 5.57 m and total fleet length of 480 m.

#### **3.1.3.2.9. Gill nets for Seer and Tuna**

Gill nets for seer and tuna operated as drifting gear at the surface or in the column waters are restricted to certain pockets of the state. Gill net generally is held vertically by a buoyant floatline at the top of the net and a leadline at the bottom. However, the drift gill nets for seer and tuna operated from the Kerala coast are devoid of sinker line or even footrope. These are operated in column or surface depending on the swimming layer of the fish during different seasons (as surface drift net during June to Sept and column drift during Oct to May). At times the floatline is rigged in such a way that it remains below the surface by adjusting the buoy lines which are attached to the float line at regular intervals. Drift nets are usually operated during nighttime.

Vijayan *et al.*, (1993) has made a comparison of the seer gill nets of Kerala during 1958 to 1991 and found that though the material and mesh sizes were changed the practice of operating this gear as drift net had not been changed.

The design of a typical net is given in figure 3.10. Regional variation in the technical specifications of the gear is given in Table 3.9.

**Material:** The type of material controls the visibility of the nets. PA multifilament twines were used throughout the coast for seer and tuna nets. These had the advantage of less rigidity than monofilament. To nullify the visibility underwater, multifilament yarns were coloured to camouflage with the environment. Brown, green and red are the colours commonly used. Earlier tannin of tamarind seed was used for dyeing the nets but nowadays-synthetic dyes are used. Throughout the centres 210dx6x3 (Rtex 455) was the most common material used. During December – January months when comparatively larger specimens of seer fishes occurred in the fishery PA 210dx9x3 (Rtex 683) and 210dx12x3 (Rtex 911) were used. The use of 210dx9x3 and 210dx12x3 was observed at Kollam, Alappuzha, and Thrissur area.

Vijayan *et al.*, (1993) also reported PA 210dx6x3 as the material commonly used for seer gill nets along Kerala coast during 1991 but hemp was in use in 1958. Sulochanan *et al.*, (1975) suggested 210dx12x3 as the optimum twine size for gill nets for *S. guttatus*. Gulbrandsen (1984) reported that large mesh nets of Kerala with twine size 210dx5x3 (Rtex 380), 210dx6x3 and 210dx7x3 (Rtex 531) were the optimum twine sizes and were well mounted. Over the years no change had occurred in the gill net material for seer and tuna unlike in other gill nets.

**Mesh size:** The mesh size ranged between 70 and 140 mm, however the most common are 90 and 100 mm (Table 3.9). Silas *et al.*, (1979) reported operation of drift gill nets of mesh size 100-150 mm for tunas off Cochin in 35 - 40 m depth zones. Yohannan and Balasubramanian (1989) and Sivadas (1994) mentioned the use of drift gill nets of mesh sizes 100 to 150 mm for scombroids at Calicut. Silas *et al.*, (1984) reported 70 to 130 mm as the mesh sizes used for drift gill nets for seer. This shows that the mesh size used presently is smaller for *S. commersoni* the most common species caught in this net.

Sreekrishna *et al.*, (1972) suggested 104 mm as the optimum mesh size for *S. guttatus* and Sulochanan *et al.*, (1975) suggested 152

mm mesh size as the optimum for the capture of *S.commersoni* of 850-950 mm size group.

**Hanging coefficient:** The hanging coefficient of the gear varied between 0.44 and 0.71 in the different regions (Table 3.9). Since the target species are strongly muscled and fast moving fishes, a hanging coefficient of 0.5 renders effective entangling of the fishes. The net is devoid of footrope or sinkers for effective entangling. In earlier reports on drift gill nets of Kerala, no mention was given on the hanging coefficient. Sreekrishna *et al.*, (1972) and Sulochanan *et al.*, (1975) experimented seer gill nets with a hanging coefficient of 0.5.

**Hung depth:** The hung depth of the nets ranged from 7.68 to 12.86 m. Regional variations were mostly felt in this aspect. Nets of maximum hung depth was used by fishermen based at Kochi fisheries harbour as the depth of operation was comparatively more (24 to more than 300 m) while fishing from mechanised crafts for oceanic species. In the motorised sector, the fishermen of the southern districts used comparatively deeper nets. This was due to the steep continental shelf of these coasts compared to the northern coasts.

The hung depth of seer gill nets ranged between 5 to 5.8 m in 1958 (Vijayan *et al.*, 1993). During late 1950s the operation was from

non-motorised crafts and the area of operation was limited and hence the lesser hung depth of the nets. Yohannan & Balasubramanian (1989) reported gear having hung depth of 10 m common in the drift net fishery for scombroids in Calicut.

**Fleet length:** The fleet length of net ranged between 255 and 2800 m. In 1958, the total length of net used for operation from a unit ranged between 157 and 450 m. The present length is almost six times of that used in 1958. This is mainly due to two reasons- mechanisation /motorisation of crafts and change in the gear material from vegetable origin to synthetic (cotton to PA). Nets of length 600 m were reported from Calicut in 1989 (Yohannan and Balasubramanian, 1989). Governments of many countries and some organisations have included under 'large scale drift net fisheries', only those nets of more than 2.5 km or only those operated outside EEZ (Northridge, 1991). Under this context it can be concluded that the drift gill net fisheries of Kerala come under the category of 'small scale drift net fisheries' except approximately 6 % of the units operated from mechanised craft based at Kochi fisheries harbour having length exceeding 2500 m. All others had a fleet length of less than 2500 m.

**Depth of operation:** Mechanised vessels operating from Kochi fisheries harbour base operate deeper than their motorised



counterparts. The depth of operation of motorised and mechanised crafts ranged between 16 and 90 m and 19 to more than 300 m respectively. The depth of operation of the non-motorised crafts during the 1950s ranged between 12 and 40 m (Vijayan *et al.*, 1993). In the mechanised sector, the area of operation was confined to 19 to 50 m depth zones during 1981-82 (Silas *et al.*, 1984). Bigger vessels, with high engine power and use of ice facilitated the fishermen to go for operations in distant and deeper waters.

#### **3.1.3.2.10. Pomfret Gill Nets**

Gill nets specifically targeted for pomfret were not recorded in Kerala before 1993. Vijayan *et al.*, (1993) reported that gill nets specifically targeted for pomfrets were becoming popular in north Kerala.

The present study revealed that pomfret gill nets are prevalent in many areas of Kerala especially from north of Alappuzha. Design of a typical pomfret gill net operated at Chavakkad, Thrissur is depicted in Fig. 3. 11. Regional variations were noticed in certain aspects such as dimensions of the net, mesh size, the details of which are given in table 3.10.

In all the centres, PA monofilament of 0.20 and 0.23 mm dia was exclusively used as the material for the net. The mesh size varied from 100 to 118 mm. The hanging coefficient ranged from 0.52 to 0.62 and the depth of operation varied between 6 and 24 m.

PA monofilament of 0.23 mm dia and mesh size of 100 to 120 mm was in use in 1991 (Vijayan *et al.*, 1993). Panikkar *et al.*, (1978) worked out 126.0 mm as the optimum mesh size for the capture of *Pampus argenteus*.

#### **3.1.3.2.11. Shark Gill Nets**

Specific shark gill netting was found in Chettikadu and Thalikulam only during the present investigation. The nets in Chettikad are of the drifting type similar to seer gill nets but of thicker PA twine (210dx12x3) and larger mesh size (130 to 140 mm). In Thalikulam few units of set gill nets of PA monofilament of 0.45 mm dia (Tex 185) with 145 mm mesh size are in operation for sharks. The design of a typical net is shown in Fig. 3.12 and the technical specifications are given in Table 3.11. The net having a total length of 320 m is positioned in water by, attaching a master float with a flag to the head rope and heavy stones to the foot rope on either ends. Every twenty-four hours the net is hauled and fish caught are removed. The net is operated at a depth of 2 to 3 m, very near to the shore usually

within a distance of 2 km from the shore. A single man operated the net. One disadvantage of this fishing method is that since the catch is removed every twenty four hours only, there is chance for deterioration of fishes caught earlier.

#### **3.1.3.2.12. Lobster Gill Nets**

Lobster gill net popularly known, as 'ral vala' is a set gill net and is found in Kollam only. Design of a typical gill net is given in Fig. 3.13 and the technical specifications are given in Table 3.12. The present study indicates that PA monofilament of 0.32 mm dia is used for lobster gill net. Fishermen are of the opinion that eventhough monofilament is more efficient than multifilament, since the grounds are rocky and the operation is bottom set, the chances of net getting damaged and lost are very high. The net is positioned by attaching a master float to the head rope and a master sinker to the footrope. Nets of around 360 m length having a mesh size of 90 mm are operated at a depth upto 64 m. Operation is carried out throughout the year.

The net was popular in Kollam and Thiruvananthapuram coast as early as in 1950s and it was reported by Vijayan *et al.*,(1993) that in 1991 PA multifilament 210dx6x3 replaced hemp used in 1950s.

### **3.1.3.3. Operational Aspects**

#### **3.1.3.3.1. Fishing Operations**

Gill net operation has been a relatively simple method compared to operation of other fishing gear. Nets were set across the current and in the path of fish migration.

In drift nets, nets are shot mostly from the side and sometimes from the stern of the vessel. The nets stored in the vessel with the floatline and floats, buoyline and buoys to one side and sinkerline and sinkers to the other side are thrown overboard manually to either side of the vessel to prevent tangling. Speed of the vessel is not a critical factor and as a general rule nets are not allowed to run out faster than the moving vessel, the speed of which during shooting could vary between 1 and 6 knots. One end of the net is tied to the vessel and the vessel drifted along with the nets. Nets operated during night have a kerosene lamp attached to a flagpole at the extreme end of the fleet to keep track of the net. The soaking time varied between half to one-hour in most cases except in seer gill nets in which the time varied between 4 and 5 hours. Hauling was generally done by the side of the vessel by pulling the floatline/headrope; the nets were cleared out and stored in the shooting position. In non-motorised and motorised

canoes, in extreme weather conditions the nets are hauled in bulk and the fish released afterwards.

In set nets, the nets provided with master buoys and flagpoles on the head rope and heavy sinkers on footrope on either ends of the fleet of nets are set overnight and hauled the following morning.

#### **3.1.3.3.2. Craft**

In gill net fishing vessels ranging from 10 ft (3.03 m) to 45 ft (13.63 m) LOA are used. These include kattamaram, dugout canoe, plank built canoe and marine plywood boats. Non-motorised, motorised and mechanised craft were engaged in gill net fishing. The craft did not have specialised equipments or arrangements as the operation was done manually. The only requirements are storage space for nets and the catch; and a smooth edged rail for the nets to slide over while shooting. Fishermen used only compass as a navigational aid. However recently vessels of above 40 ft (12.1 m) LOA which could cover distant waters engaged in long duration trips were using GPS (global positioning system). The details regarding the craft and other related parameters are given in Table 3.13.

In central Kerala, the plank-built and dug out canoes were almost completely replaced by marine plywood boats in the

motorised sector fitted with outboard motors of 9.9 to 15 hp (mostly of 9.9 hp). In Thiruvananthapuram, engines of 25-hp also were used. In northern Kerala from Kozhikode onwards, the use of two engines of 9.9 hp each was common for seer gill net operation. Unlike in trawling or seining, in gill netting the motor power was used for propulsion only and the entire fishing operation viz., setting and hauling was carried out manually. Therefore, the use of very high-powered motor was not very common. Earlier, when motorisation started, the out board motors (OBMs) used in gill net fishery were of 7 hp (Panikkar *et al.*, 1993). The enhancement in use of engine power was not substantial over the years compared to other fisheries. In ring seine sector, the enhancement in the power of OBMs was from 20-24 hp in 1986 (year of introduction) to a cumulative hp of 85-90 hp in 1996-97 (Edwin, 1997) and 130-145 hp in 1998 (SIFFS, 1999).

Craft in the mechanised sector comprise wooden plank -built boats of length ranging from 8.48 to 13.64 m with inboard diesel engines of 60 or 90 hp. Of late from mid 1999 onwards many boats of less than 10 m were rebuilt to bigger sizes of 12-14 m LOA. The mechanised drift gill net fishing operation in the inshore waters of Cochin in 1969 was with pablo type crafts of 7.9 to 9.1 m LOA. The enhancement of engine power was not substantial over the years in

the mechanised sector also, as in 1969 mechanised gill-netters used engines of 25-45 hp which is currently increased to 60-90 hp.

#### **3.1.3.3.3. Man Power**

The manpower engaged in each craft is shown in Table 3.13. The use of outboard engines reduced the manpower requirement in drift net fishing units. However, the crew attached to each unit depended on the fishermen population of the locality. In areas where the population is high, even though 3 to 4 persons were going onboard the vessel the total crew attached to the unit was as high as 10 to 12 and was engaged in turns. Typical cases were seen in Chettikad and Chellanam. The reduction of crew in the drift gill net fishery due to motorisation was reported by Yohannan and Balasubramanian (1989) and by Sivadas (1994).

#### **3.1.3.3.4. Trip Duration**

Non-motorised and motorised sector carried out only single day operations except in the seer gill net sector of the northern districts where the motorised plywood canoes carried out 2 day operation. In the mechanised sector, till 1995, only single day operations were carried out. From 1994-95 onwards, the use of insulated fish holds (in the form of ice boxes of 0.5 to 1 tonne

capacity fixed on the deck) and ice on board the vessel paved way to multiday operations. Vessels later built were provided with in built fish holds of 0.75 to 3 tonne capacity. Thus multiday operations, initially 2 day to 5 day duration and later by 1998-99, 6 day to 14 day were regular. Vessels in the size range of 14-15 m LOA fitted with 90 hp engines later added to the fishery by 1999 could stay upto two weeks in the sea. This has made distant and deeper areas accessible to the fishermen.



## ***SECTION 2.***

### **3.2. EVALUATION OF DESIGN ASPECTS**

#### **3.2.1. Introduction**

The design aspects of the gear are important as design falls in line with the target species, viz. its behaviour, habitat, and shape and has an influence on the catch composition. A properly designed gill net can be used as an effective tool for exploitation of the resource with minimum ill effects such as discards and bycatch, on the ecosystem.

In gill nets, the most important aspects, which have an influence on catching efficiency, are the mesh size, visibility, hanging coefficient and rigging viz. the application of optimum buoyancy and weight to keep the net in the desired position. The visibility of the nets, primarily depends on the material viz. its thickness, colour and type. The thickness of the material in relation to mesh size is important as catching efficiency and durability of the net depend on this. Baranov (1976) suggested that a normal ratio (twine size to mesh size) for gill nets is 0.01. At this ratio, the nets have sufficient fishing

efficiency and strength. Changes have taken place in the gill net sector primarily in the replacement of material. The material has been changed from cotton and hemp to PA multifilament and later to PA monofilament. In PA monofilament also, the tendency is to go for thinner and thinner material. PA monofilament, the most popular material at present, has very short service life due to breakage and tear and also due to the weathering effect. Hence an examination of the existing twine size-mesh size relationship was done to see whether the normal d/a ratio is maintained in nets currently used. Simultaneously an assessment of the weathering resistance of PA multifilament and monofilament yarn of comparable thickness was also taken up.

Typically for a gill net, the hanging ratio (ratio of the length of the net when rigged to the fully stretched length of the net) might be between 0.5 and 0.7. Hanging ratio lower than these results in distortion of meshes and the consequent entangling. In a tropical inshore fishery, the catch comprises of different size of fishes and also different varieties of fishes viz., smooth bodied and those having spines and other protruding appendages. In the present investigation hanging coefficient of 0.50 to 0.71 was encountered in different nets. Exceptions were seer gill nets and echa vala (nets operated for

mackerel and small tuna in Kollam -Thiruvananthapuram coasts) which are entangling nets . To find out how the hanging coefficient affects the catching mechanism in different fishes, analysis of the mode of capture of fishes in a gill net hung at 0.57 coefficient was carried out.

There are two forces at work on the netting when suspended in water, a floating force and a sinking force. In order to keep a net suspended in a given position, there must be a balance of the floating force (created by the floats) and a sinking force (created by the sinkers, weight of the webbing and ropes). Sainsbury (1996) reported a ratio of sinking force to buoyancy as 2:2.5. By altering the buoyancy of the net, the head rope height and the netting curve shape are altered and in effect the drag also is changed (Baranov, 1976). There is no standard ratio for providing buoyancy for gill nets since it mainly depends on fishing conditions. The amount of floats and sinkers is given arbitrarily based on the fisherman's experience and local conditions. No work has been done on the rational application of floats and sinkers except an attempt by Mukundan and Mathai (unpublished). Hence an attempt is made to evaluate whether the floatation in gill nets follow any definite pattern.

Fridman (1986) suggested that the distribution of floats in a gill net should not be more than 75 % of the depth of the net. Spacing more than this would result in undue sagging of the net resulting in loss of effective area of the net. The design and rigging of different nets were examined to find out the distribution of floats.

### **3.2.2. Materials and Methods**

#### **3.2.2.1. Twine Size - Mesh Size Relationship**

The twine size mesh size ratio was worked out as

$$\frac{d}{a} = \frac{\text{twine diameter}}{\text{stretched mesh size}} \quad (\text{same units of measurement})$$

The weathering resistance of PA monofilament of 0.32 mm dia (Tex 90) and PA multifilament of 0.37 mm dia (Rtex 51) were assessed by exposing samples to sunlight for 180 days and testing the loss in strength. The methodology is detailed in Chapter 4. (4.2.)

#### **3.2.2.2. Mode of Capture**

An examination of the mode of capture of sardines (oil sardine) and sciaenids was carried out at Beach road centre at Kannamaly, Ernakulam. The nets were of PA monofilament of 0.16 mm dia and mesh sizes of 32, 34, 36 and 38 mm hung at 0.57. The fishes selected were sardine which represent a smooth bodied fish and sciaenids

mostly of *Johnius Spp.* and *Otolithes Spp.* representing fishes having spines and protruding appendages. Mode of capture viz. number of fishes gilled, wedged or entangled was recorded for around 300 fishes in each category.

### 3.2.2.3. Buoyancy –Weight Relationship in Gill Nets

The buoyancy coefficient was worked out as below following Fridman (1986).

$$KQ = Q_f / Q_n$$

Where

$KQ$  = Buoyancy coefficient

$Q_f$  = Buoyancy required

$Q_n$  = Weight in water of mainline and netting

The weight of sinker was worked out as

$$Q_S = Q_n$$

Where  $Q_S$  = weight of sinkers in water

$Q_n$  = weight in water of mainline and netting

The extra buoyancy of floats and the weight in water of the net were worked out as below following (Prado, 1990).

$$\text{Weight (kg) in water } P = A \times (1 - DW/DM)$$

Where  $A$  = weight (kg) in air

$DW$  = density (g/cc) of water

$DM$  = density (g/cc) of material

$$\text{Extra buoyancy (gf)} = 0.67 \times L \text{ (cm)} \times \varnothing^2 \text{ (cm)}$$

Where L = length or height of the cylindrical float

$\varnothing$  = diameter

In the case of irregular shaped floats, JICA (1981) was followed.

$$F = V - W$$

Where F = extra buoyancy(g)

V = volume (cc)

W = weight in air (g)

Sinking force per unit of net was calculated as per JICA (1981).

$$W' = W (1 - 1/p)$$

Where, W' = Sinking force (g)

W = weight in air (g)

p = sp.gr. of the material

#### **3.2.2.4. Distribution of Floats**

The hung depth of the net was calculated as follows

$$D = N_2 L_m \sqrt{1 - E^2}$$

where D = theoretical height (m)

$N_2$  = No. of meshes in depth

$L_m$  = mesh size (mm)

E = hanging coefficient

The length of head rope /float line between adjacent floats was

measured for each net and the distance as percentage of hung depth

calculated.

### **3.2.3. Results and Discussion**

#### **3.2.3.1. Twine Size - Mesh Size Relationship**

Table 3.14 shows the twine size mesh size ratio worked out for different gill nets. In general the material used presently is much thinner than their earlier counterparts. The ratio for PA multifilament was worked out as 0.01 while for PA monofilament it ranged between 0.002 to 0.006. Except in seer and white sardine nets the ratio was much lower than the normal. Pomfret nets had the thinnest twine in relation to the mesh size followed by shark, lobster and polynemus nets. It indicated that twine used in relation to mesh size was very thin as the availability of thin material with high strength urged the fishermen to go for thinner and thinner material.

The ratio in 1958, 1991 and 1999 (present data) showed a gradual decrease in thickness in almost all nets. For example, the material used for prawn gill nets in 1970s was 210dx1x2 (Nedelec, 1975) and for sardine gill nets was cotton 20/4/1 in 1962 (Satyanarayana and Sadanandan, 1962) and PA 210x2x2 (Tex 101) in 1964 (Joseph and Sebastian, 1964). Taking breaking strength or diameter as the criteria, the replacement with PA monofilament should have been with PA monofilament of 0.24 or 0.25 mm dia

respectively in prawn gill net and 0.35 and 0.33 mm dia respectively in sardine gill nets. But the replacement for these two nets was with PA monofilament of 0.20 mm and at present even with PA monofilament of 0.16 mm dia. This clearly showed that fishermen are focussing mainly on catching efficiency. The main reason for this trend is the availability of monofilament, which possesses low visibility and high breaking strength at comparatively low thickness. Eventhough monofilament possessed lesser tenacity and wet knot strength; its transparent nature compensated for the greater breakage and tear.

The weather resistance of PA multifilament and monofilament after 180 days of exposure to sunlight showed that while PA multifilament of 0.37 mm dia retained only 25.31 % of the breaking strength, PA monofilament of 0.32 mm dia retained 70.43 % of the breaking strength (Fig. 3.14). This showed that monofilament was more resistant than multifilament. Therefore, the use of PA monofilament of very thin diameter than its multifilament counterpart accounted for its short life.



### **3.2.3.2. Mode of Capture of Fishes**

Fig. 3.15 depicts the mode of capture of sardines and sciaenids in the net. In the net with hanging coefficient 0.57, 60.2 % of the total sardines caught was by gilling while 53.4 % of the total sciaenids caught was by entangling. This indicated that a hanging coefficient of 0.50 and above was suitable for both gilling and entangling of different fishes. Nets meant for catching fish by gilling and wedging should be of hanging ratio higher than entangling nets and generally ranges from 0.5 to 0.8 (Karlsen and Bjarnason, 1987). Sainsbury (1996) suggested that for gilling fish, the hanging coefficient is usually between 0.5 to 0.66 with 0.6 being common.

### **3.2.3.3. Buoyancy-Weight Relationship**

The design and rigging of sardine gill nets, mackerel gill nets, and seer gill nets from different centres were analysed to study the distribution of buoyancy and sinking force.

#### **Buoyancy-Ballast Ratio**

The calculated buoyancy of floats on the head rope and the weight of sinkers on the foot rope per metre and per unit area of netting in sardine and mackerel nets are indicated in Table 3. 15 and

3.16 respectively. There was not much variation between the two nets in the buoyancy of floats and weight of sinkers in air per unit length of head rope and footrope. The ratio of buoyancy and weight was approximately 0.6 in both the nets in majority of the cases. The average of the ratio from all the centres was 0.65 for sardine nets and 0.62 for mackerel nets.

Satyanarayana and Sadanandan (1962) also reported a similar observation in sardine and mackerel gill nets. While the material has been changed from cotton to PA monofilament and the mode of operation from encircling to drifting, the same ratio is maintained in the present investigation. However, the buoyancy and weight in air per unit length on head rope and footrope has been reduced compared to the earlier values. In sardine gill net, the buoyancy was 146.2 g and weight of sinkers in air, 221.5 g per unit length in 1962 (Satyanarayana and Sadanandan, 1962). In the present investigation it is 24.16 and 43.45 g respectively. Like wise in mackerel gill net, the buoyancy was 149.7 g and weight of sinkers in air was 202.8 g per unit length in 1962 (Satyanarayana and Sadanandan, 1962). In the present investigation it is 30.50g and 49.73 g respectively. This reduction is due to the change of material from cotton to PA.

In seer gill nets, the average buoyancy per metre of headrope is 115.33 g (Table 3. 17). It ranged between 63.78 g and 195.39 g in different centres. It indicates that compared to sardine and mackerel nets, the floatation used in seer gill nets is high. This is because seer nets targeted for fast moving large fishes are operated in deeper waters where the current is strong. In calm waters and when fish sizes are relatively small, lower ranges of buoyancy and ballast are used to decrease the tension on netting and make it more pliable (Fridman, 1986 and Hameed and Boopendranath, 2000).

The ratio of sinking force to buoyancy (Table 3.18, 3.19) shows that it is 0.82 for sardine nets and 0.84 for mackerel nets. Sainsbury (1996) suggested 0.8 as the ratio of sinking force to buoyancy in gill nets.

### **Buoyancy Coefficient**

Fridman (1986) suggested that the buoyancy coefficients in gill nets should be between 3 and 6. He also suggested that nets operated for large fish, in strong currents and in snaggy bottom, values would be at the higher range, and for calm waters, small fish and smooth bottom, values would be at the lower part of the range.

In the present study, the buoyancy coefficients worked out for seer, sardine and mackerel gill nets (Table 3.17, 3.18 and 3.19) are 4.42, 3.49 and 2.15 respectively. The sardine nets which were operated in comparatively shallower water, has the lowest coefficient and the seer nets, which are operated in deeper water, has the highest values. Thus the results are in conformity with the observations of Fridman (1986).

### **Ballast Requirement**

In drift gill nets, the weight of sinkers in water is equal to the weight in water of webbing and main lines (Fridman, 1986). A comparison of these values for sardine and mackerel nets (Table 3.18 and 3.19) indicates that only in nets from a few centres this is followed. Since the depth of operation and the local conditions viz. ground topography and currents vary from centre to centre fishermen normally adjusted the position of nets in water by changing the weight of sinkers. This might be the reason for the non-compatibility between weight in water of sinkers and netting while the buoyancy coefficients generally showed an almost uniform pattern in different centres.

Seer gill nets, which do not possess foot rope or sinkers, the compatibility between weight of sinkers and netting in water was not examined. In these nets, the position of the nets to different depths is adjusted by the master floats or buoys viz. by adjusting their number as well as length of the buoy line.

From the overall results, a general trend could be arrived at for each type of net. But as (Baranov 1976) opined it is very difficult to give location specific recommendations for each type of net. Fishermen usually solve the problem purely empirically based on the local conditions and based on his experience.

#### **3.2.3.4. Distribution of Floats**

Table 3.20 shows that except in lobster gill nets, the floats are distributed within the limits recommended by Fridman (1986). In lobster nets, the floats are spaced at a distance of 81 % of the hung depth. In small mesh gill nets, the distance ranged between 22.75 to 46.59 % only. Except in lobster, pomfret and prawn gill nets, the distance is less than 50 % of the hung depth. The results show that the distribution of floats in gill nets of Kerala except in one or two cases is justifiable in order to have better effective area.

Table 3.1. Technical specifications of mackerel gill nets in different centres

Centre	Mariyand	Moothakara	Moothakara	Moothakara	Arthikallal	Chellanam	Manassery	Puthu Vype	Thalikulam	Chavakkad	Kozhikode	Talassery	Kannur city
Local name	echa vala	echa vala	noovala	aila vala	aila vala	aila vala	aila vala	aila vala	aila vala	aila vala	aila vala	pachu vala	pachu vala
Main webb. mesh size (mm)	56	60	55	50 (48-52)	50 (48-52)	52	40	50	50	50	54	54	54
Twine type	PA multi	PA multi	PA multi	PA mono	PA mono	PA mono	PA mono	PA mono	PA mono	PA mono	PA mono	PA mono	PA mono
Twine specification/ dia (mm)	210x1x3	210x1x3	210x1x2	0.20	0.20	0.20	0.20	0.20	0.23	0.20	0.23	0.23	0.23
Meshes in depth (no.)	250	300	150	100	100	200	100	150	150	150	150	150	150
Hang coefficient (E1)	0.44	0.43	0.55	0.57	0.57	0.62	0.54	0.57	0.59	0.62	0.53	0.64	0.52
Meshes (no./unit)	4870	12000	3600	5600	5600	5000	3010	5600	5400	2574	3612	918	5500
Hung length (m)	120.0	307.2	108.6	160.0	160.0	160.0	64.5	160.0	160.2	80.0	103.2	31.7	154.0
Hung depth (m)	12.46	16.28	6.84	4.10	4.10	8.21	3.36	6.15	6.15	5.85	6.8	6.15	6.88
Selvedge twine type	PA	PA	PA	PA	PA	PA	PA	PA	PA	PA	PA	PA	PA
Selv (twine specification)	210x3x3	210x3x3	210x3x3	210x3x3	210x3x3	210x2x3	210x2x3	210x3x3	210x2x3	210x1x2	210x2x3	210x2x3	210x2x3
Selvedge mesh size (mm)	60	60	85	60	60	60	80	60	100	50	56	60	54
Selvedge meshes in depth (no.)	2	2.5	3	2	2	3	4	2	3	2	2	2	5
Selv (upper&lower) hung depth (m)	0.10	0.13	0.43	0.20	0.20	0.28	0.54	0.20	0.49	0.16	0.19	0.18	0.46
Total hung depth (m)	12.56	16.33	7.27	4.30	4.30	8.49	3.9	6.35	6.64	6.01	6.99	6.33	7.34
Head rope- type	pe	pp	pp	pp	pp	pp	pp	pe	pp	pp	pp	pp	pp
Head rope-dia (mm)	5	5	4	3	3	4	4	4	4x2	3	4	4	4
Float type	PVC	PVC	PVC	PVC	PVC	PVC	PVC	PVC	PVC	PVC	PVC	PVC	PVC
Float dimensions (mm)	60x20	60x20	60x20	60x20	60x20	60x20	60x20	60x20	60x20	60x20	60x20	60x18	60x20
Floats/unit	50	120	60	100	100	100	43	100	90	46.8	86	18	110
Foot rope type	nil	nil	pp	pp	pp	pp	pp	PE	PP	PP	PP	PP	PP
Foot rope (dia)	nil	nil	4	3	3	4	4	4	4	2	4	3	4
Sinker type	Granite	Granite	Granite	Granite	Granite	concrete	lead	Granite	Granite	Granite	Granite	Granite	Granite
Sinker weight (g)	250	150	150	250	250	250	26.3	150	150	150	150	150	150
Sinkers/unit	5	30	30	33.33	33.33	50	21.5	50	45	23.4	43	9	55
Total flet length (m)	720	845	650	960	960	800-1040	320 - 510	880	800	800	640	720	800-960
Depth of operation (m)	16 - 40	40-64	32-40	24	24	32-40	4.8 - 11.2	20	27-29	27-29	15-28	16-48	32 - 48
Craft	Plywood canoe	Plywood canoe	Plywood canoe	Plank canoe	Plank canoe	Plank transom	Plank canoe	Dug out canoe	Plywood canoe	Plywood canoe	Plywood canoe	Plywood canoe	Plywood canoe
Craft-HP	25	9.9	8	9.9	9.9	9.9	nil	9.9	9.9	9.9	9.9	9.9	9.9

Centre	Mariand	Iravipuram	Moothakara	Artinkal	Manassery	Beach Road	Puthu Vype	Chavakkud	Kozhikode	Talassery	Kannur city
Local name	Edakettu vala	Edakettu vala	karichala vala	chala vala	chala vala	chala vala	chala vala	pattam vala	chala vala	chala vala	pachu vala
Main webb mesh size (mm)	40	40	30	32	36	36	38	30	38	38	30
Twine type	PA mono	PA multi	PA multi	PA mono	PA mono	PA mono	PA mono	PA mono	PA mono	PA mono	PA mono
Twine specification/dia (mm)	0.23	210x1x2	210x1x2	0.20	0.16	0.16	0.16	0.20	0.20	0.20	0.16
Meshes in depth (no.)	200	200	300	150	100	100	100	150	200	150	200
Hang coefficient (EI)	0.59	0.70	0.55	0.63	0.53	0.57	0.57	0.53	0.68	0.62	0.56
Meshes (no./unit)	6800	2280	9600	8000	3354	2601.6	7380	7500	780	1792	9240
Hang length (m)	160.0	64.0	157.6	160.0	63.9	53.3	159.9	120.0	20.3	42.2	154.0
Hang depth (m)	6.47	5.68	7.47	3.7	3.02	2.95	3.12	3.78	5.55	4.45	4.92
Selvedge twine type	PA	PA	PA	PA	PA	PA	PA	PA	PA	PA	PA
Selvy twine specification	210x2x3	210x2x3	210x3x3	210x3x3	210x2x3	210x2x3	210x2x3	210x1x2	210x2x3	210x2x3	210x2x3
Selvedge mesh size (mm)	80	65	50	50	70	60	60	40	60	40	50
Selvedge meshes in depth (no.)	2	2	5	4	2	2	2	2	4	2	4
Selvy (upper& lower) hang depth (m)	0.26	0.19	0.42	0.31	0.23	0.20	0.20	0.13	0.35	0.13	0.33
Total hang depth (m)	6.73	5.87	7.89	4.01	3.25	3.15	3.32	3.91	5.90	4.58	5.25
Head rope - type	PE	PP	PP	PP	PP	PP	PE	PP	PP	PP	PP
Head rope-dia (mm)	4	3	5	3	4	4	4	3	4	4	5
Float type	PVC	PVC	PVC	PVC	PVC	PVC	PVC	PVC	PVC	PVC	PVC
Float dimensions (mm)	60x20	60x20	60x20	50x20	50x20	50x20	50x20	50x20	55x18	50x20	50x20
Floats/unit	80	40	80	100	42.6	33	123	75	15	32	110
Foot rope type	PE	PP	PP	PP	PP	PP	PE	PP	PP	PP	PP
Foot rope (dia)	4	3	5	3	4	4	4	2	4	4	5
Sinker type	Cement block	Granite	Granite	Granite	Lead & granite	Lead	Granite	Granite	Clay	Clay	Granite
Sinker weight (g)	150	150	150	250	26.3 and 100	26.3	150	150	50	50	100
Sinkers/unit	40	20	40	25	10.7 and 10.6	33	50	37.5	15	32	55
Total fleet length (m)	1000	330	790	800	320 - 510	640	480	480	640	420	800
Depth of operation (m)	16 - 24	30-32	64	24	3.2 to 9.6	6.5	6 to 8	15-20	16 to 20	16-19	16 - 30
Craft	Plywood canoe	Kattamaram	Plywood canoe	plank canoe	plank canoe	plank canoe	Dug out canoe	Plywood canoe	Plywood canoe and dug out	Plywood canoe	Plywood canoe
Craft-HP	25	nil	9.9	9.9	nil	nil	nil	9.9	9.9	9.9	9.9

Table. 3.3. Technical specifications of white sardine gill nets in different centres

Centre	Kozhikode	Thalassery city	Kannur city
Local name	chooda vala	chooda vala	chooda vala
Main webb.mesh size (mm)	24 (16-26)	16 (16-26)	20 (16-26)
Twine type	PA multi	PA multi	PA multi
Twine specification/ dia (mm)	210x1x2	210x1x2	210x1x2
Meshes in depth (no.)	400	200	200
Hang.coefficient ( E1)	0.58	0.63	0.59
Meshes (no.)/unit	11424	5333	13440
Hung length (m)	159.6	53.3	159.6
Hung depth (m)	7.81	2.50	3.24
Selvedge twine type	PE	PE	PE
Selv.twine specification-dia (mm)	2	2	2
Selvedge mesh size (mm)	60	60	80
Selvedge meshes in depth (no.)	4	4	4
Selv (upper&lower) hung depth (m)	0.39	0.37	0.51
Total hung depth (m)	8.20	2.87	3.75
Head rope- type	PP	PP	PP
Head rope-dia (mm)	3	4	3
Float type	PVC	PVC	PVC
Float dimensions (mm)	42x16	55x18	40x16
Floats/unit	168	66.7	168
Foot rope type	pp	PP	PP
Foot rope (dia)	3	3	2
Sinker type	Clay	Clay	Clay
Sinker weight (g)	50	100	100
Sinkers/unit	168	8	33
Total fleet length (m)	420	420	800
Depth of operation (m)	8 to 10	6.4 to 8	8 to 10
Craft	Plywood canoe	Plywood canoe	Plywood canoe
Craft-HP	9.9	9.9	9.9



Table.3.4. Technical specifications of anchovy gill net in different centres

Centre	Marianad	Iravipuram
Local name	natholi vala	natholi vala
Main webb.mesh size (mm)	14	14
Twine type	PA multifilament	PA multifilament
Twine specification/ dia (mm)	210x1x2	210x1x2
Meshes in depth (no.)	600	600
Hang.coefficient ( E1)	0.56	0.55
Meshes (no.)/unit	11400	11154
Hung length (m)	90	85.8
Hung depth (m)	6.88	6.97
Selvedge twine type	PA	PA
Selv.twine specification-dia (mm)	210x3x3	210x3x3
Selvedge mesh size (mm)	50	50
Selvedge meshes in depth (no.)	5	5
Selv (upper&lower) hung depth (m)	0.41	0.42
Total hung depth (m)	7.29	7.39
Head rope- type	PE	PE
Head rope-dia (mm)	3	3
Float type	PVC	PVC
Float dimensions (mm)	40x20	40x20
Floats/unit	75	78
Foot rope type	PE	PE
Foot rope-dia (mm)	3	3
Sinker type	Granite	Granite
Sinker weight (g)	150	150
Sinkers/unit	37	39
Total fleet length (m)	360	158
Depth of operation (m)	4 to 8	4 to 8
Craft	Plywood canoe	Kattamaram
Craft-HP	9.9	nil

Table. 3.5. Technical specifications of mullet gill net

Centre	Manassery
Local name	Malan vala
Main webb.mesh size (mm)	30 (30-36)
Twine type	PA monofilament
Twine specification/ dia (mm)	0.16
Meshes in depth (no.)	100
Hang.coefficient ( E1)	0.56
Meshes (no.)/unit	3829
Hung length (m)	64.0
Hung depth (m)	2.49
Selvedge twine type	PA multifilament
Selv.twine specification-dia (mm)	210x2x3
Selvedge mesh size (mm)	60
Selvedge meshes in depth (no.)	2
Selv (upper&lower) hung depth (m)	0.20
Total hung depth (m)	2.69
Head rope- type	PP
Head rope-dia (mm)	4
Float type	PVC
Float dimensions (mm)	60x20
Floats/unit	55
Foot rope type	PP
Foot rope - dia (mm)	4
Sinker type	Lead
Sinker weight (g)	26.3
Sinkers/unit	27
Total fleet length (m)	320 - 800
Depth of operation (m)	10 to 16
Craft	Plank built canoe
Craft-HP	nil

Table 3.6. Technical specifications of prawn gill net

Centre	Beach road
Local name	Chemmeen vala
Main webb.mesh size (mm)	36 (34-52)
Twine type	PA monofilament
Twine specification/ dia (mm)	0.16
Meshes in depth (no.)	100
Hang.coefficient ( E1)	0.53
Meshes (no.)/unit	2897
Hung length (m)	55.3
Hung depth (m)	3.02
Selvedge twine type	PA multifilament
Selv.twine specification-dia (mm)	210x2x3
Selvedge mesh size (mm)	70
Selvedge meshes in depth (no.)	1.5
Selv (upper&lower) hung depth (m)	0.17
Total hung depth (m)	3.19
Head rope- type	PP
Head rope-dia (mm)	4
Float type	PVC
Float dimensions (mm)	60x20
Floats/unit	42.6
Foot rope type	PP
Foot rope-dia (mm)	3
Sinker type	Lead
Sinker weight (g)	26
Sinkers/unit	85.2
Total fleet length (m)	480-640
Depth of operation (m)	3.2-11.2
Craft	Plank built canoe
Craft-HP	nil

Table. 3.7. Technical specifications of lactarius gill net

Centre	Moothakara
Local name	Parava vala, Edakettu vala
Main webb.mesh size (mm)	35
Twine type	PA multifilament
Twine specification/ dia (mm)	210x1x2
Meshes in depth (no.)	200
Hang.coefficient ( E1)	0.71
Meshes (no.)/unit	4560
Hung length (m)	114
Hung depth (m)	4.90
Selvedge twine type	PA multifilament
Selv.twine specification-dia (mm)	210x3x3
Selvedge mesh size (mm)	57
Selvedge meshes in depth (no.)	3
Selv (upper&lower) hung depth (m)	0.24
Total hung depth (m)	5.14
Head rope- type	PP
Head rope-dia (mm)	4
Float type	PVC
Float dimensions (mm)	45x18
Floats/unit	60
Foot rope type	PP
Foot rope-dia (mm)	4
Sinker type	Granite
Sinker weight (g)	150
Sinkers/unit	30
Total fleet length (m)	600
Depth of operation (m)	64
Craft	Plywood canoe
Craft-HP	8

Table. 3.8. Technical specifications of polynemus gill net

Centre	Chellanam
Local name	Vazhmeen vala
Main webb.mesh size (mm)	65
Twine type	PA monofilament
Twine specification/ dia (mm)	0.20
Meshes in depth (no.)	100
Hang.coefficient ( E1)	0.54
Meshes (no.)/unit	1800
Hung length (m)	63.2
Hung depth (m)	5.46
Selvedge twine type	PA multifilament
Selv.twine specification-dia (mm)	210x2x3
Selvedge mesh size (mm)	65
Selvedge meshes in depth (no.)	1
Selv (upper&lower) hung depth (m)	0.11
Total hung depth (m)	5.57
Head rope- type	PP
Head rope-dia (mm)	3
Float type	PVC
Float dimensions (mm)	60x20
Floats/unit	40
Foot rope type	PP
Foot rope-dia (mm)	3
Sinker type	Granite
Sinker weight (g)	150
Sinkers/unit	20
Total fleet length (m)	480
Depth of operation (m)	6.4 - 16
Craft	Plank canoe
Craft-HP	nil

Table 3.9. Technical specifications of gill nets for seer and tuna in different centres

Centre	Marianad	Vadi	Chettikad	Kochi Fish Harbour	Thalikulam	Chavakkad	Kozhikode	Thalassery	Kannur city
Local name	kanatha vala	kanatha vala	ozhukku vala	ozhukku vala	ozhukkuvala	ozhukkuvala	ozhuku vala	odu vala	odu vala
Main webb mesh size (mm)	100	130 (130-140)	100	120 (90-120)	95	90	100	90 (70-140)	95 (95-140)
Twine type	PA multi	PA multi	PA multi	PA multi	PA multi	PA multi	PA multi	PA multi	PA multi
Twine specification/ dia (mm)	210x5x3	210x9x3 and 210x12x3	210x6x3	210x6x3	210x6x3	210x6x3	210x6x3	210x6x3	210x6x3
Meshes in depth (no.)	120	85	110	120	104	120	110	120	110
Hang coefficient (E1)	0.63	0.49	0.53	0.44	0.61	0.71	0.53	0.53	0.63
Meshes (no./unit)	1900	3948	1000	9090	2000	2100	1174	2184	6750
Hung length (m)	120	253.8	53	480	116.5	135	62.2	104	405
Hung depth (m)	9.24	9.61	9.24	12.81	7.80	7.56	9.24	9.07	8.04
Selvedge twine type	PE	PE	PE	PE	PE	PE	PE	PE	PE
Selvy twine specification-dia (mm)	2	2	2 mm	2	2	2 mm	2.5	2.5	2.5
Selvedge mesh size (mm)	100	150	100	120	95	90	100	100	100
Selvedge meshes in depth (no.)	0.5	1	1	0.5	0.5	2	0.5	0.5	0.5
Selvy (upper only) hung depth (m)	0.04	0.13	0.08	0.05	0.03	0.12	0.04	0.03	0.03
Total hung depth (m)	9.28	9.74	9.32	12.86	7.83	7.68	9.28	9.11	8.07
Head rope- type	PE	PP	PP	PP	PP	PP	PE	PP	PP
Head rope-dia (mm)	5	6	4	6x2	4x2	3 x2	6	6	5
Float type	PVC	PVC	PVC	PVC	PVC	PVC	PVC	PVC	PVC
Float dimensions (mm)	100x20	100x20	100x20	100x20	100x20	100x20	100x20	100x20	100x20
Floats/unit	50	94	22	150	50	60	26	26	150
Foot rope type	nil	nil	nil	nil	nil	nil	nil	nil	nil
Foot rope-dia (mm)	nil	nil	nil	nil	nil	nil	nil	nil	nil
Sinker type	nil	Granite	Granite	nil	Granite	nil	Granite	nil	nil
Sinker weight (g)	nil	50	750	nil	100	nil	100	nil	nil
Sinkers/unit	nil	94	2 / fleet	nil	8.33	nil	1	nil	nil
Total fleet length (m)	1800-2100	255-275	800-2400	1440 - 2800	580	1890	980	1040	900-1200
Depth of operation (m)	24 - 90	19	64	24 to > 300	29-35	18-35	16-52	56	56 - 64
Craft	Plywood canoe	Plywood canoe	Plywood canoe	mech wooden vessel	Plywood canoe	Plywood canoe	Plywood canoe	Plywood canoe	Plywood canoe
Craft-HP	9.9, 15, 25	9.9	9.9	60-90	9.9	9.9	9.9 (2nos)	9.9 (2 nos.)	9.9 (2 nos.)

Table 3.10. Technical specifications of pomfret gill net in different centers 75

Centre	Arthikhal	Puthu Vype	Thalikulam	Chavakkad	Thalassery city	Kannur city
Local name	Avoli vala	Avoli vala	Avoli vala	Avoli vala	Avoli vala	Avoli vala
Main webb mesh size (mm)	110	118	100 (100-110)	105	100	105
Twine type	PA mono	PA mono	PA mono	PA mono	PA mono	PA mono
Twine specification/ dia (mm)	0.20	0.20	0.20	0.20	0.20	0.23
Meshes in depth (no.)	100	65	60	60	100	65
Lang. coefficient ( EI)	0.62	0.45	0.59	0.56	0.53	0.58
Meshes (no./unit)	6533	3060	2550	1635	3000	2640
Hung length (m)	447.98	163.20	151.20	95.92	159.98	161.04
Hung depth (m)	8.58	6.82	4.83	5.16	8.46	5.52
Selvedge twine type	PA multi	PA multi	PA multi	PA multi	PA multi	PA multi
Selv. twine specification-dia (mm)	210x3x3	210x2x3	210x1x2	210x2x3	210x2x3	210x2x3
Selvedge mesh size (mm)	110	120	100	105	100	105
Selvedge meshes in depth (no.)	2	2	2	2	2	2
Selv (upper&lower) hung depth (m)	0.34	0.42	0.32	0.34	0.33	0.34
Total hung depth (m)	8.92	7.24	5.12	5.50	8.73	5.86
Head rope- type	PP	PE	PP	PP	PP	PP
Head rope-dia (mm)	4	4	4	3	4	4
Float type	PVC	PVC	PVC	PVC	PVC	PVC
Float dimensions (mm)	100x20	100x20	100x20	100x20	100x20	100x20
Floats/unit	93	34	60	55	33	66
Foot rope type	PP	PE	PP	PP	PP	PP
Foot rope-dia (mm)	3	4	3	2	3	4
Sinker type	Concrete	Granite	Concrete	Concrete	Concrete	Concrete
Sinker weight (g)	250	250	150	500	250	250
Sinkers/unit	93	34	15	14	33	25
Total fleet length (m)	960	880	560	480-960	640	640
Depth of operation (m)	24	6 to 8	10 to 16	10	8	8
Craft	Plankbuilt canoe	Dug out canoe	Plywood canoe	Plywood canoe	Plywood canoe	Plywood canoe
	nil	10	10	10	10	10

Table. 3.11. Technical specifications of shark gill nets in different centres

Centre	Chettikad	Thalikulam
Local name	Ozhukku vala, Sravu va	sraku vala
Main webb.mesh size (mm)	130	145
Twine type	PA multi	PA mono
Twine specification/ dia (mm)	210x12x3	0.45
Meshes in depth (no.)	85	50
Hang.coefficient ( E1)	0.49	0.50
Meshes (no.)/unit	3948	2200
Hung length (m)	253.80	159.28
Hung depth (m)	9.61	6.28
Selvedge twine type	PE	PA multi
Selv.twine specification-dia (mm)	2	210x3x3
Selvedge mesh size (mm)	150	150
Selvedge meshes in depth (no.)	1	2
Selv. hung depth (m)	0.13 (upper only)	0.52 (upper & lower)
Total hung depth (m)	9.74	6.80
Head rope- type	PP	PP
Head rope-dia (mm)	6	4
Float type	PVC	PVC
Float dimensions (mm)	100x20	100x20
Floats/unit	94	44
Foot rope type	nil	PP
Foot rope-dia (mm)	nil	3
Sinker type	Granite	Cement block
Sinker weight (g)	50	300
Sinkers/unit	94	88
Total fleet length (m)	800-1280	320
Depth of operation (m)	19-54	3.2 - 6.4
Craft	Plywood canoe	Dug out canoe
Craft-HP	9.9	nil



Table. 3.12. Technical specifications of lobster gill net

Centre	Iravipuram
Local name	Ral vala
Main webb.mesh size (mm)	90
Twine type	PA mono
Twine specification/ dia (mm)	0.32
Meshes in depth (no.)	70
Hang.coefficient ( E1)	0.63
Meshes (no.)/unit	2100
Hung length (m)	120
Hung depth (m)	4.87
Selvedge twine type	PA
Selv.twine specification-dia (mm)	210x2x3
Selvedge mesh size (mm)	100
Selvedge meshes in depth (no.)	3
Selv (upper&lower) hung depth (m)	0.46
Total hung depth (m)	5.33
Head rope- type	PP
Head rope-dia (mm)	4
Float type	PVC
Float dimensions (mm)	100x20
Floats/unit	15
Foot rope type	PP
Foot rope-dia (mm)	4
Sinker type	Granite
Sinker weight (g)	150
Sinkers/unit	218
Total fleet length (m)	360
Depth of operation (m)	40-64
Craft	Kattamaram
Craft-HP	nil

Table 3.13. Details of craft and manpower in gill net fishery

Sl. No.	Type	LOA (m)	Engine (hp)	Crew	Districts where used
1	Kattamaram (3 log)	3.03 - 7.57	Non-mot./ 2 hp	1-3	Kollam, Thiruvananthapuram
2	Kattamaram (4 log)	3.63 - 7.57	Non-mot./ 2 hp	1-3	-do-
3	Dug out canoe	4.54 - 5.45	Non-mot.	1-2	Ernakulam to Kasargode
4	-do-	5.45 - 7.57	Non-mot./ 2 hp	2-3	-do-
5	-do-	7.57 - 9.09	9.9 hp	4-5	Ernakulam to Kasargode
6	Plank transom	7.57 - 9.09	8, 9.9, some times 15 hp	4-5	Kollam to Thrissur
7	Plank canoe	4.54 - 7.57	Non-mot.	2	Kollam to Malappuram
8	-do-	7.57 - 12.12	9.9, 15 hp (mostly 9.9)	4-6	Alappuzha
9	Plywood boat	7.87 - 9.09	9.9, 15 and 25 (mostly 9.9)	4-6	Thiruvananthapuram to Kasargode except Ernakulam
10	Mechanised wooden boat	8.48 - 13.64	60-90 hp	6-10	Neendakara, Kochi, Thrissur, Kannur

**Table 3.14 Twine size-mesh size relationship in different gill nets**

Sl. No	Gill net type	Material	Twine diameter/mesh size (d/a)	
			Present data	Previous records
1	Sardine	PA monofilament	0.004	0.02 (1958)*
		PA multifilament	0.01	0.01 (1991)**
2	Mackerel	PA multifilament	0.007	0.02 (1958)
		PA monofilament	0.003 – 0.004	0.007 (1991)
3	White sardine	PA multifilament	0.01	0.01 (1991)
4	Anchovy	PA multifilament	0.02	0.04 (1958)
5	Prawn	PA monofilament	0.004	0.01(1975)***
6	Mullet	PA monofilament	0.005	-
7	Lactarius	PA multifilament	0.01	-
8	Polynemus	PA monofilament	0.003	-
9	Seer	PA multifilament	0.008 – 0.01	0.01(1958)
10	Pomfret	PA monofilament	0.002	0.002 (1991)
11	Shark	PA multifilament	0.01	0.01 (1958)
		PA monofilament	0.003	
12	Lobster	PA multifilament	-	0.01 (1958)
		PA monofilament	0.003	-

\* and \*\*(Vijayan et al. 1993)

\*\*\* (Nedelec,1975)

**Table 3.15. Buoyancy distribution in sardine gill nets 75**

Centre	Length (m)	Depth (m)	Floats		Sinkers		Buoyancy in 'g'		Weight in 'g'		Ratio of buoyancy to weight
			No./unit	Buoyancy y (g)	No./unit	Weight (g)	Per metre	Per Sq.m	Per metre	Per Sq.m	
Kannur city	154.00	5.25	110	3685.0	55	5500	23.93	4.56	35.71	6.80	0.67
Thalassery	42.24	4.58	32	1072.0	32	3200	25.38	5.54	75.76	16.54	0.34
Kozhikode	20.25	5.90	15	547.2	15	1500	27.02	4.58	74.07	12.55	0.36
Chavakad	120.00	3.91	75	2512.5	37.5	5625	20.94	5.35	46.88	11.99	0.45
Puthuvype	159.9	3.32	123	4120.5	50	7500	25.77	7.76	46.90	14.13	0.55
Beach Road	53.30	3.15	33	1105.5	33	867.9	20.74	6.58	16.28	5.17	1.27
Manassery	64.50	3.90	43	1440.5	21.3	1341.4	22.33	5.73	20.80	5.33	1.07
Arthinkal	160	4.01	100	3350	25	6250	20.94	5.22	39.06	9.74	0.54
Moothakara	157.6	7.89	80	3859.2	40	6000	24.49	3.10	38.07	4.83	0.64
Iravipuram	64	5.87	40	1929.6	20	3000	30.15	5.14	46.88	7.99	0.64
Marianad	160	6.73	80	3859.2	40	6000	24.12	3.58	37.50	5.57	0.64

**Table 3.16. Buoyancy distribution in mackerel gill nets 75 o**

Centre	Length (m)	Depth (m)	Floats		Sinkers		Buoyancy in 'g'		Weight in 'g' of sinkers		Ratio of buoyancy to weight
			No./unit	Extra buoyancy	No./unit	total weight	Per metre	Per sq.m	Per metre	Per sq.m	
Kannur city	154.0	6.88	110	5306.40	55	8250	34.46	4.69	53.57	7.30	0.64
Thalassery	31.68	6.15	18	781.488	9	1350	27.39	3.90	42.61	6.73	0.64
Kozhikode	103.2	6.80	86	4148.64	43	6450	40.20	5.75	62.50	8.94	0.64
Chavakkad	80.03	5.85	46.8	2257.63	23.4	3510	28.21	4.69	43.86	7.30	0.64
Thalikulam	160.2	6.15	90	4341.60	45	6750	27.10	4.08	42.13	6.35	0.64
Puthuvype	160.0	6.15	100	4824.00	50	7500	30.15	4.75	46.88	7.38	0.64
Chellanam	160.0	8.21	100	4824.00	50	10000	30.15	3.55	62.50	7.36	0.48
Arthinkal	160.0	4.10	100	4824.00	33.33	8332.5	30.15	7.01	52.08	12.11	0.58
Moothakara	108.6	6.84	60	2894.40	30	4500	26.65	3.67	41.44	5.70	0.64

**Table 3.17. Buoyancy distribution in seer gill nets 75 p**

Centre	Length per unit (m)	Floats		Master floats		Total Extra buoyancy (g)	Buoyancy per m HR (g)	Buoyancy coefficient (KQ)
		No. per unit	Extra buoyancy (g)	No. per unit	Extra buoyancy (g)			
Kannur city	405	150	20100	10	18520	38620	95.35	4.39
Thalassery	104	26	3484	1.7	3148	6632	63.77	2.09
Kozhikode	62.2	26	3484	1	1852	5336	85.78	3.27
Chavakad	135	60	8040	5	9260	17300	128.14	5.10
Thalikulam	116.5	50	6700	8.3	15427	22127	189.93	8.68
Kochi Fish. Harbour	480	150	20100	10	18520	38620	80.45	2.97
Chettikad	53	22	2948	4	7408	10356	195.39	3.62
Vadi	253.8	94	12596	5.8	10742	23338	91.95	2.34
Marianad	120	50	6700	3.33	6167	12867	107.22	7.29

**Table 3.18. Buoyancy weight relationship in sardine gill nets from different centers 75 a**

Centre	Buoyancy/ unit length (g/m)	Sinking force/ unit length (g/m)	Ratio of Sinking force to buoyancy	Buoyancy coefficient (KQ)	Weight in air (webbing and accessories) (g)	Weight of main line and netting in sea water (g)	Weight of sinkers in sea water (g)
Kannur city	23.928	35.714	0.91	-7.51	21.449	1716	3245
Thalassery city	25.403	37.915	0.61	2.81	8.393	712	848
Kozhikode	24.754	36.946	0.61	1.73	4.558	397	398
Puthuvype	25.769	46.904	1.12	3.92	26.264	1947	4425
Arthinkal	20.938	39.062	0.64	1.56	32.068	2600	3687
Iravipuram	30.15	46.875	0.96	1.70	16.155	1316	1770
Marianad	24.12	37.500	1.03	1.18	44.966	3782	2580

**Table 3.19 Buoyancy weight relationship in mackerel gill nets from different centers** 75 2

Centre	Extra Buoyancy/unit length (g/m)	Sinking force/unit length (g/m)	Buoyancy coefficient (KQ)	Ratio of Sinking force to buoyancy	Weight in air of a unit of net (webbing and accessories) (g)	Weight of main line and netting in sea water (g)	Weight of sinkers in sea water (g)
Kannur city	34.457	53.571	3.21	0.96	35.8	2858	4868
Thalassery city	27.391	42.61	3.45	0.96	8.4	501	797
Kozhikode	40.2	62.5	3.86	0.96	24.7	1885	3806
Chavakkad	28.220	43.87	3.16	0.96	12.9	938	2071
Thalikulam	27.106	42.134	3.50	0.96	35.9	3123	3983
Puthuvype	30.168	46.875	3.13	0.96	29.3	2052	4425
Manassery	32.16	8.766	-35.76	0.24	4.6	448	515
Chellanam	30.15	62.5	2.82	0.92	35.4	2604	4300
Arthinkal	30.15	52.078	4.96	1.06	22.8	1421	4916
Moothakara	26.652	41.436	3.33	0.96	20.9	1722	2655
Marianad	20.1	10.41	0.88	0.32	32.509	3054	738



**Table 3.20. Distribution of floats in gill nets** 755

Sl.No.	Gill net type	Average distance between floats as % of hung depth of net
1	Sardine	36.70 (24.33 - 55.42)*
2	Mackerel	27.53 (13.01 - 44.41)
3	White sardine	24.19 (12.17 - 32.03)
4	Anchovy	22.75 (17.39 - 28.11)
5	Prawn	58.1
6	Mullet	46.59
7	Lactarius	38.78
8	Polynemus	28.18
9	Seer	35.19 (25.80 - 50.88)
10	Pomfret	51.93 (33.68 - 56.74)
11	Shark	58.1
12	Lobster	81.63

\* Figures in brackets denote range

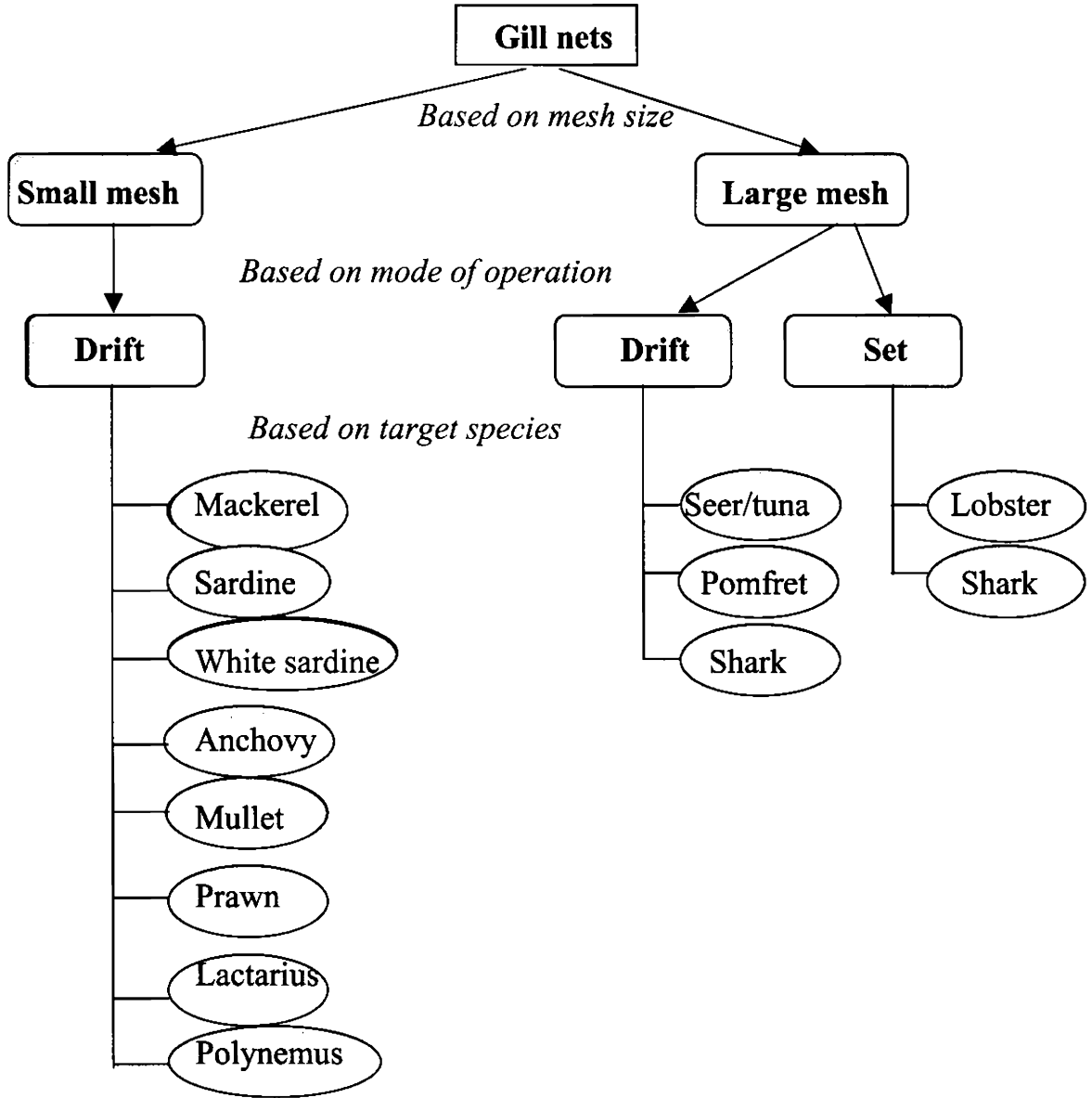


Fig. 3.1. Classification of gill nets of Kerala

GILL NET  
MACKEREL  
(CHELLANAM, ERNAKULAM)

75 u

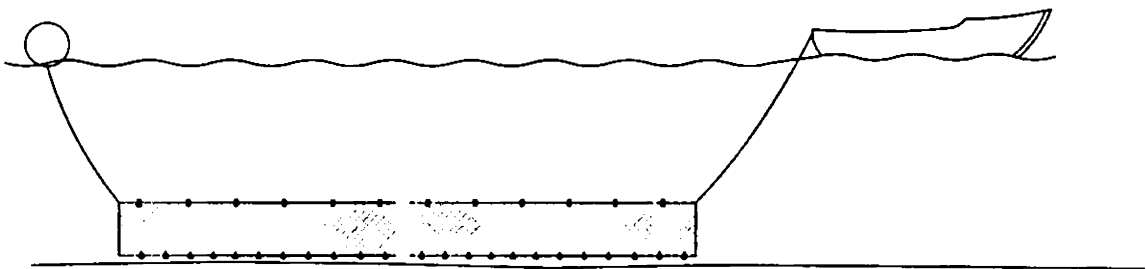
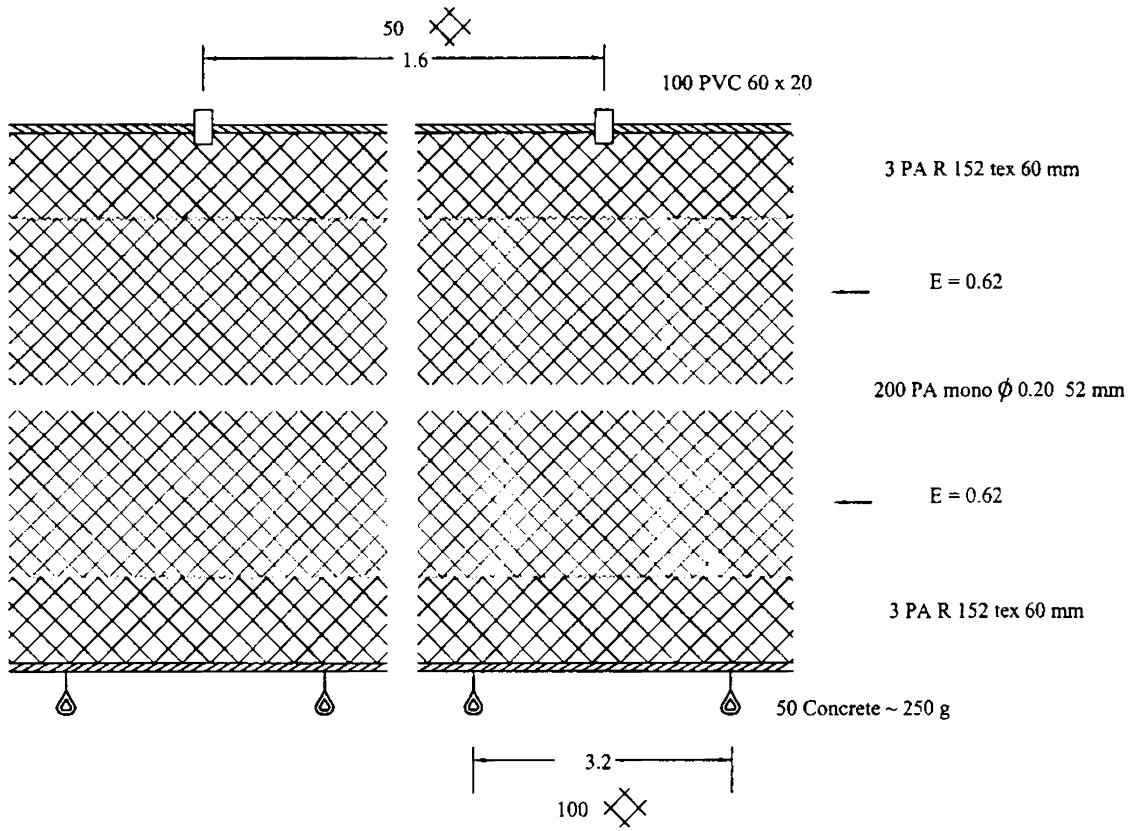
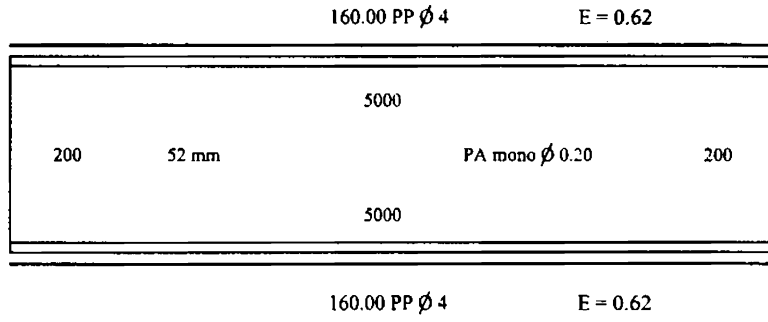


Fig 3.2. Design of gill net - Mackerel

GILL NET  
SARDINE  
BEACH ROAD (ERNAKULAM)

75 v

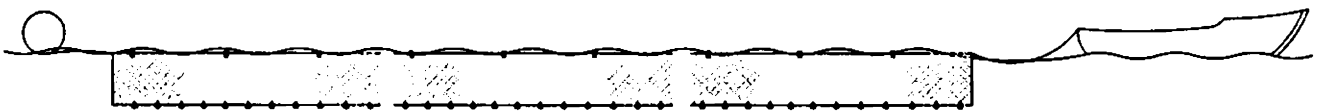
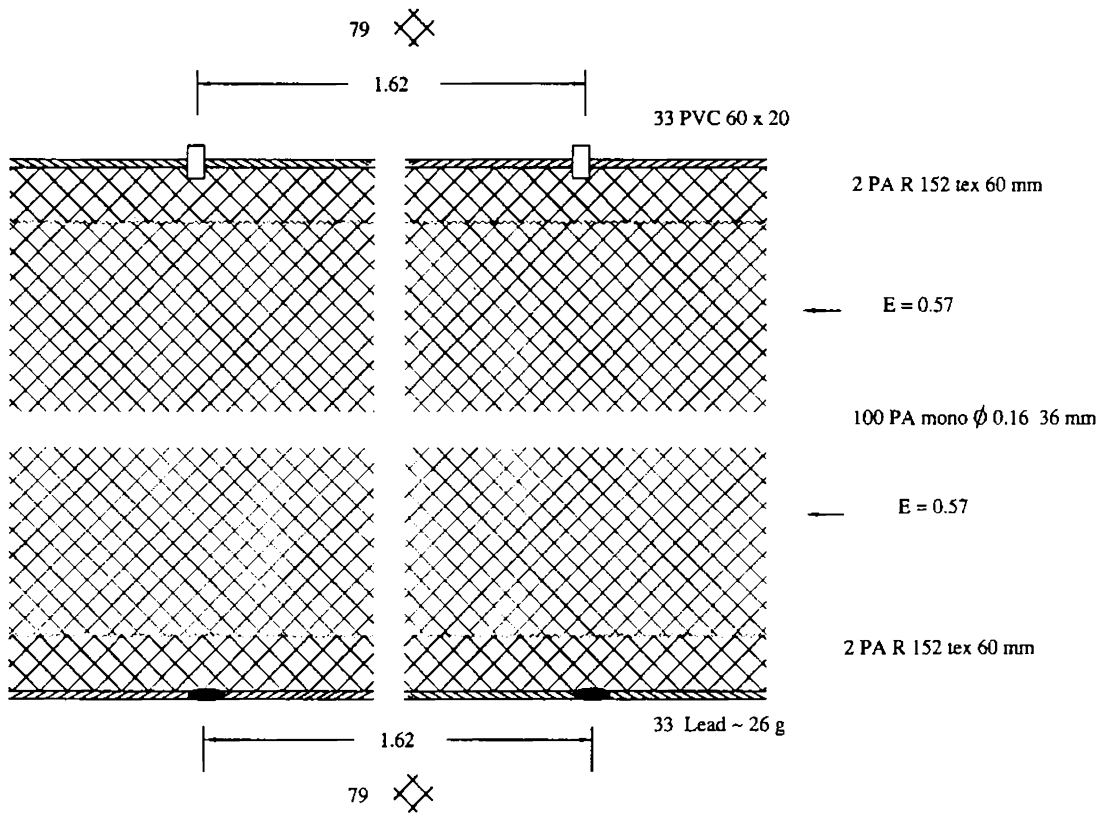
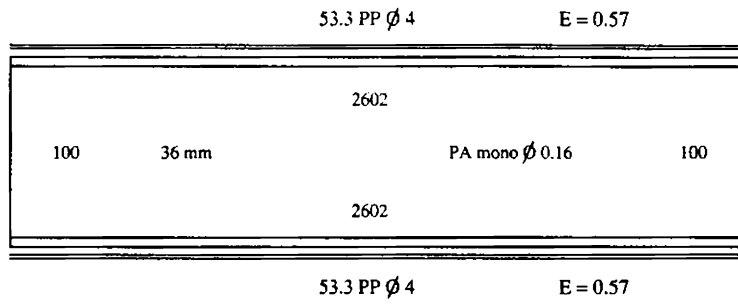


Fig 3.3. Design of gill net - Sardine

GILL NET  
 WHITE SARDINE (Veloori)  
 KANNUR CITY

75 w

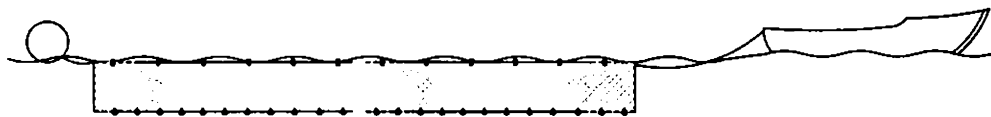
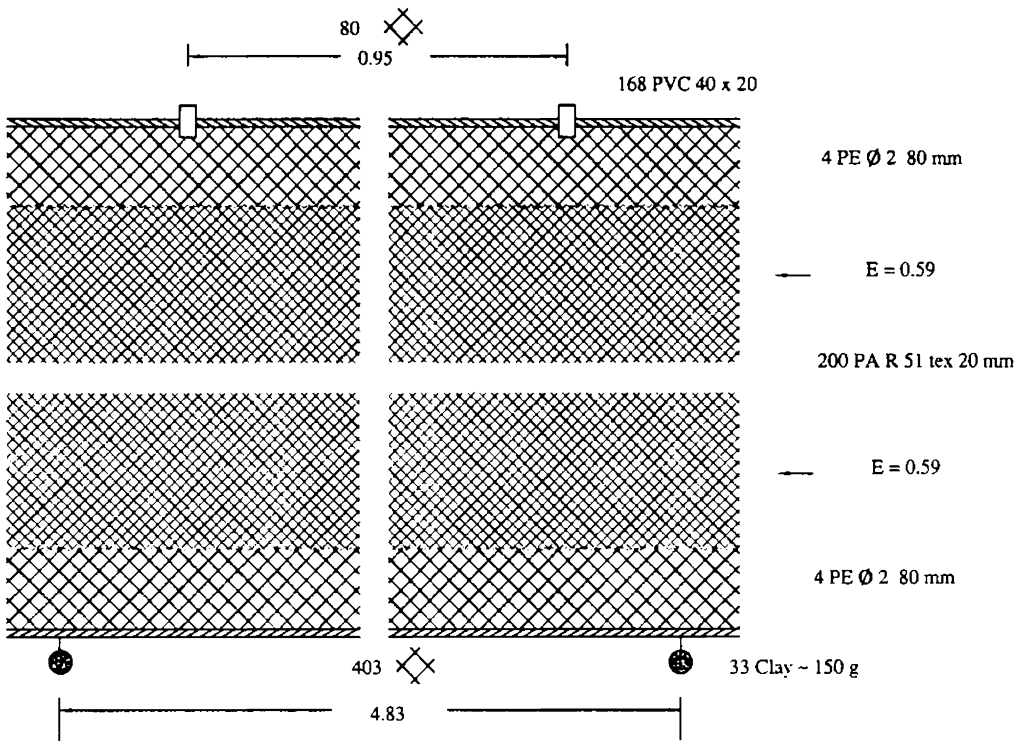
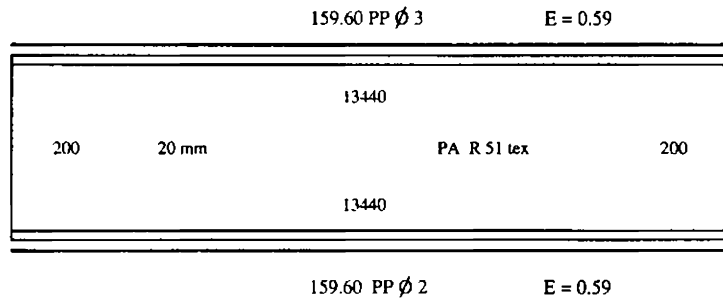


Fig 3.4. Design of gill net - White sardine

GILL NET  
 ANCHOVY  
 MARIAND (THIRUVANANTHAPURAM)

75 x

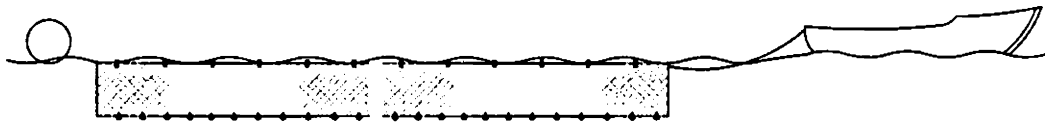
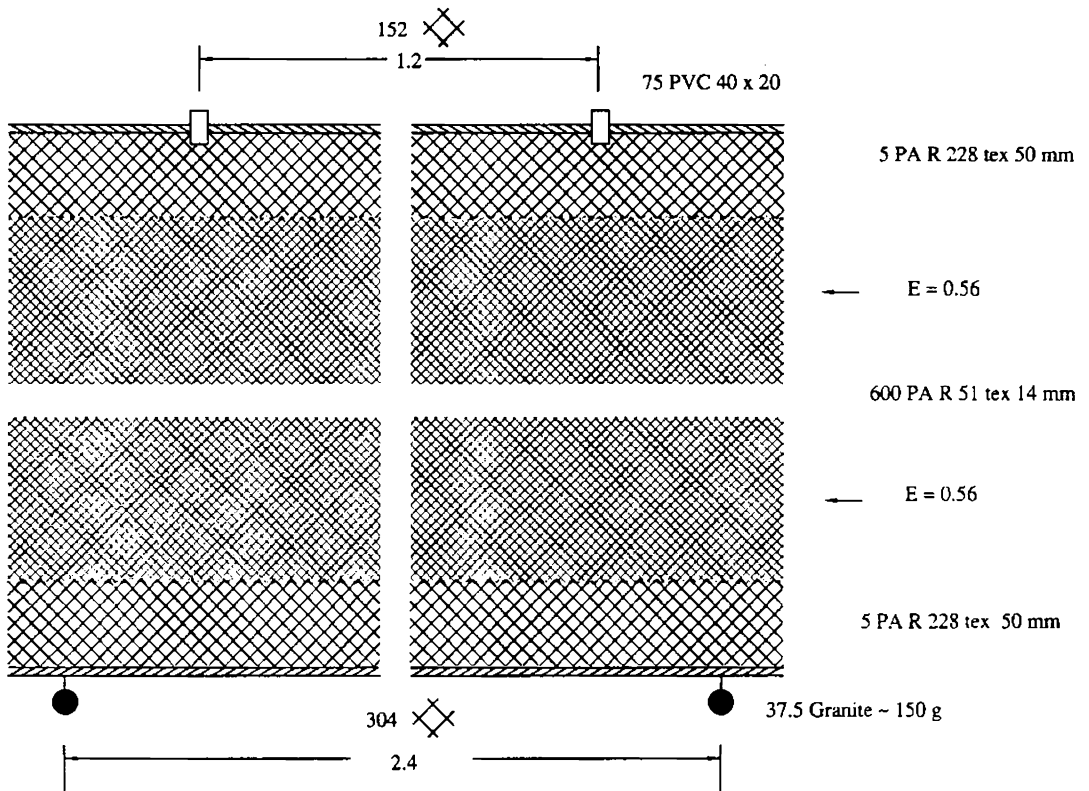
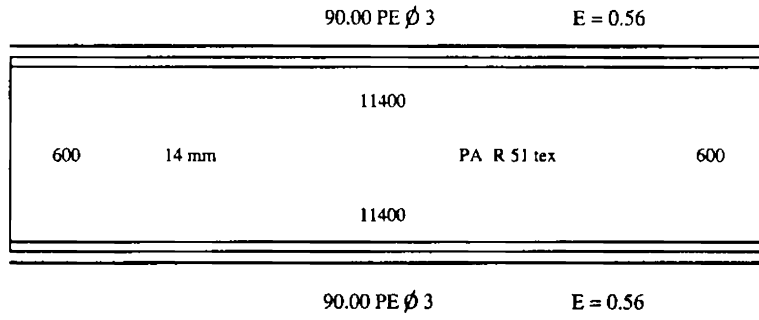


Fig 3.5. Design of gill net - Anchovy

75 y

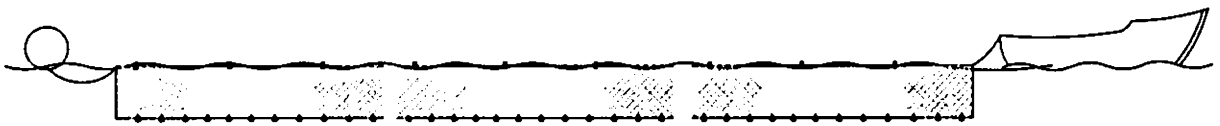
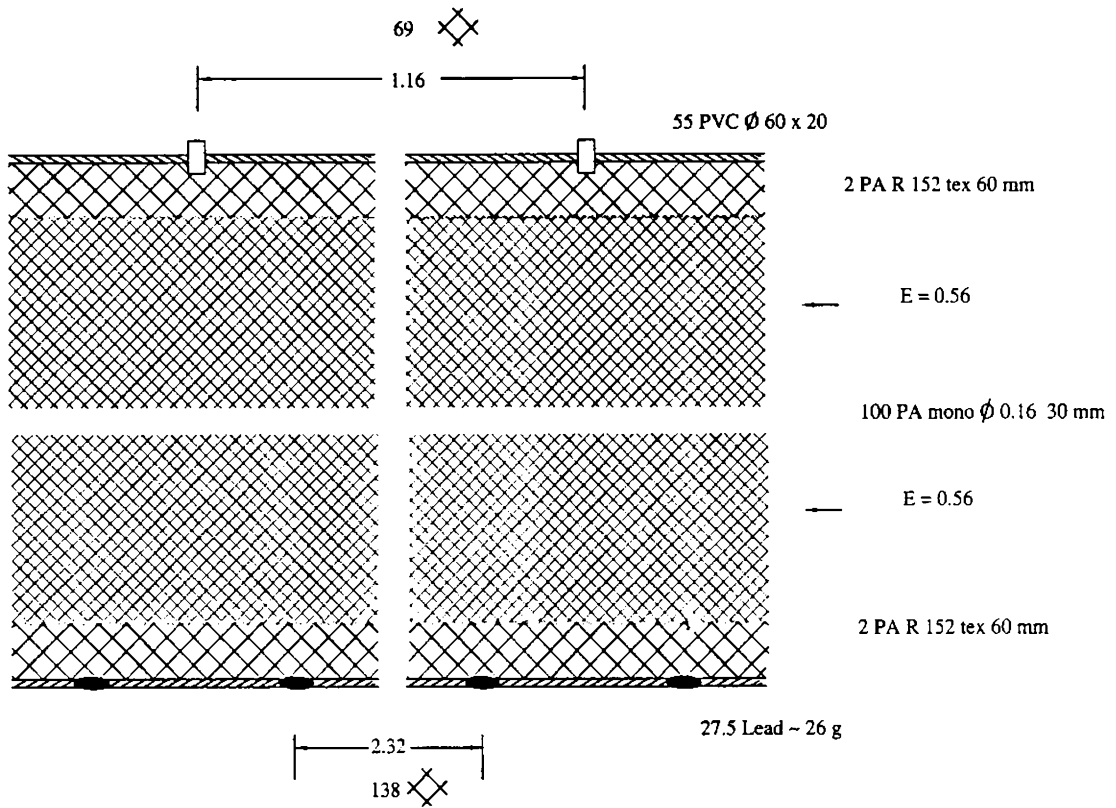
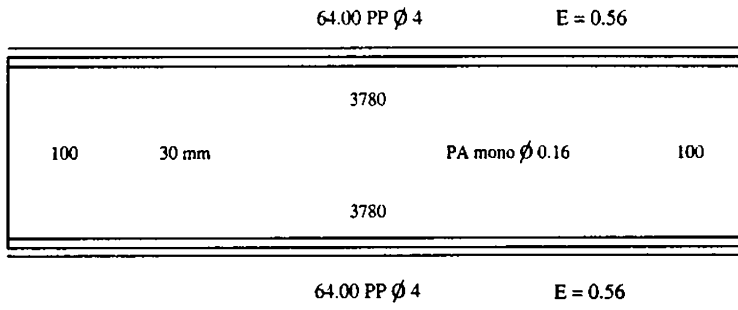


Fig 3.6. Design of gill net - Mullet

752

GILL NET  
PRAWN  
KANNAMALY (ERNAKULAM)

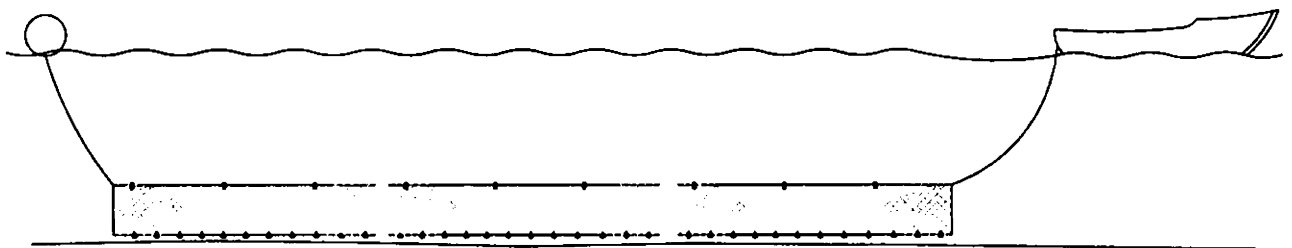
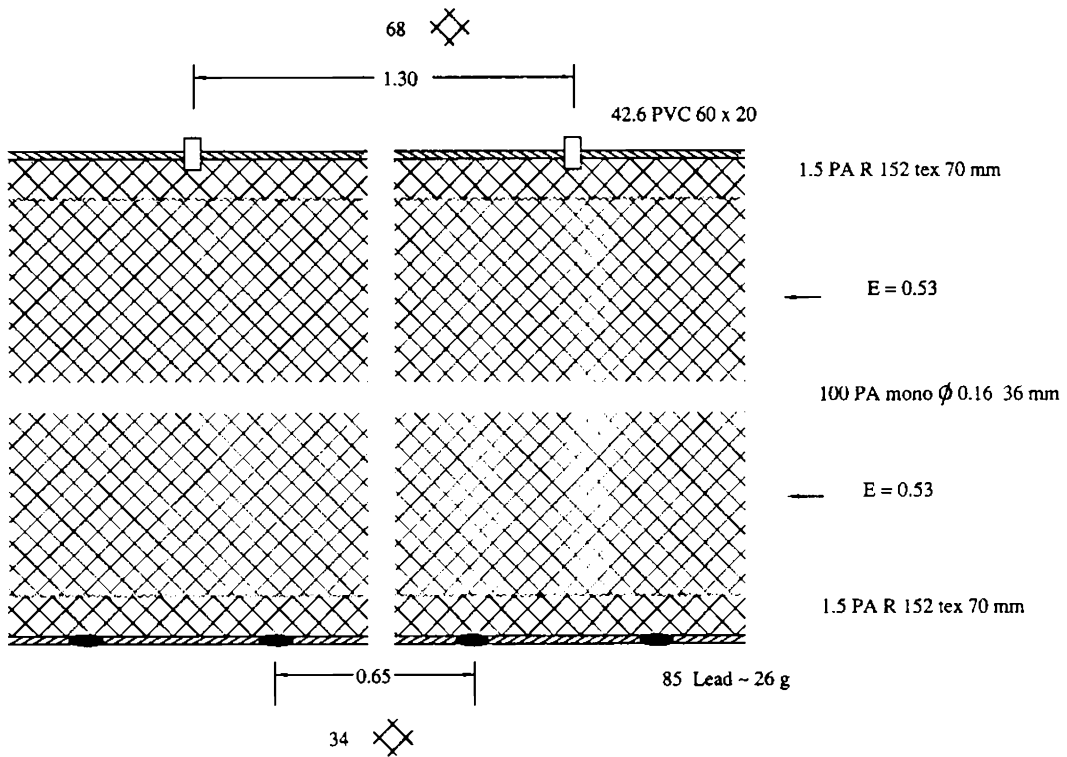
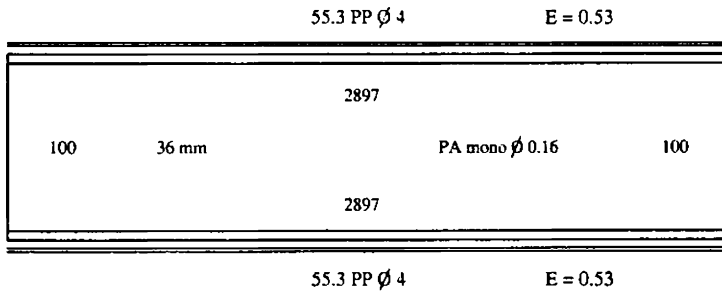


Fig 3.7. Design of gill net - Prawn



GILL NET  
LACTARIUS  
IRAVIPURAM (KOLLAM)

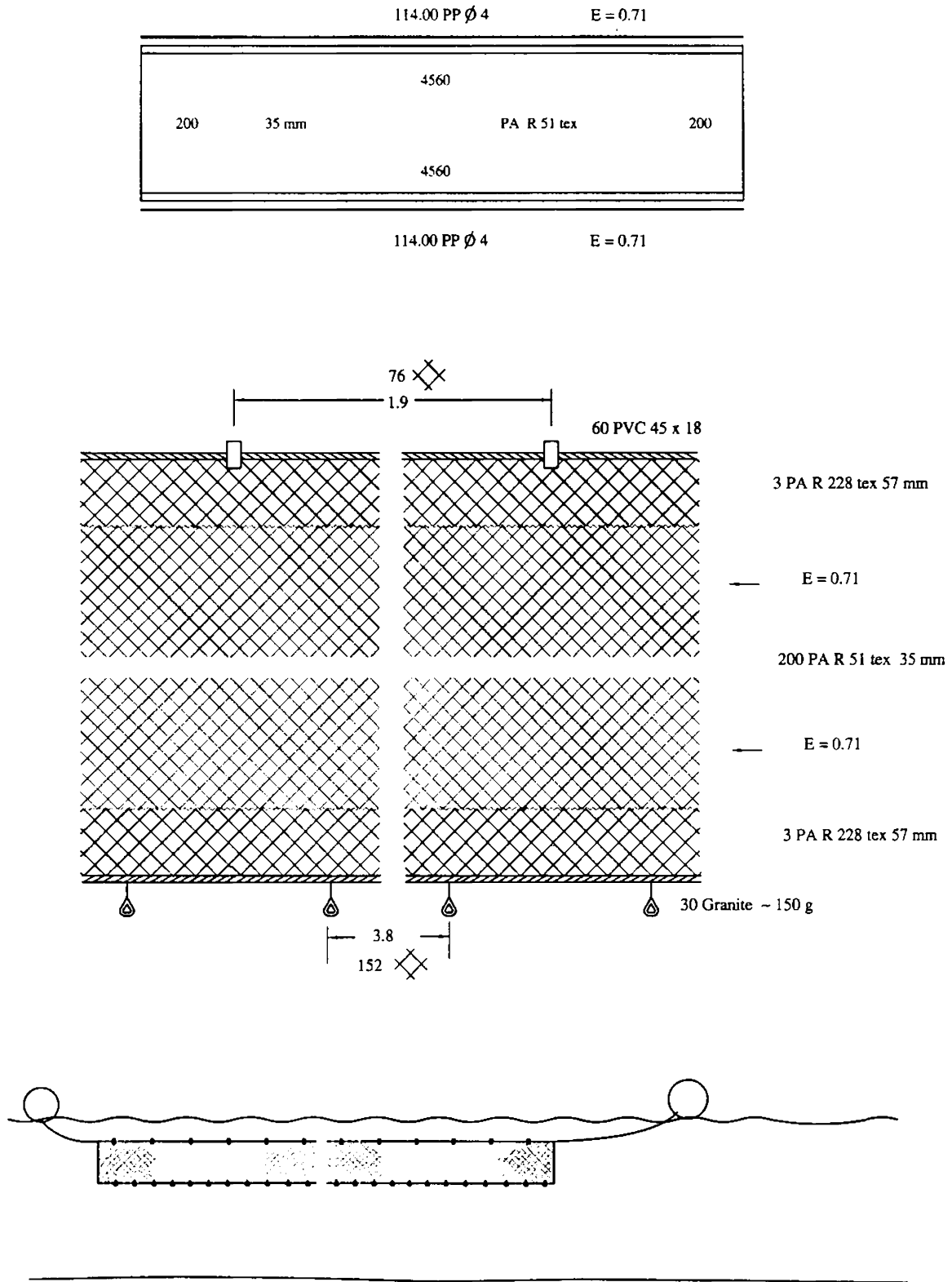


Fig 3.8. Design of gill net - Lactarius

GILL NET  
POLYNEMUS  
CIELLANAM (ERNAKULAM)

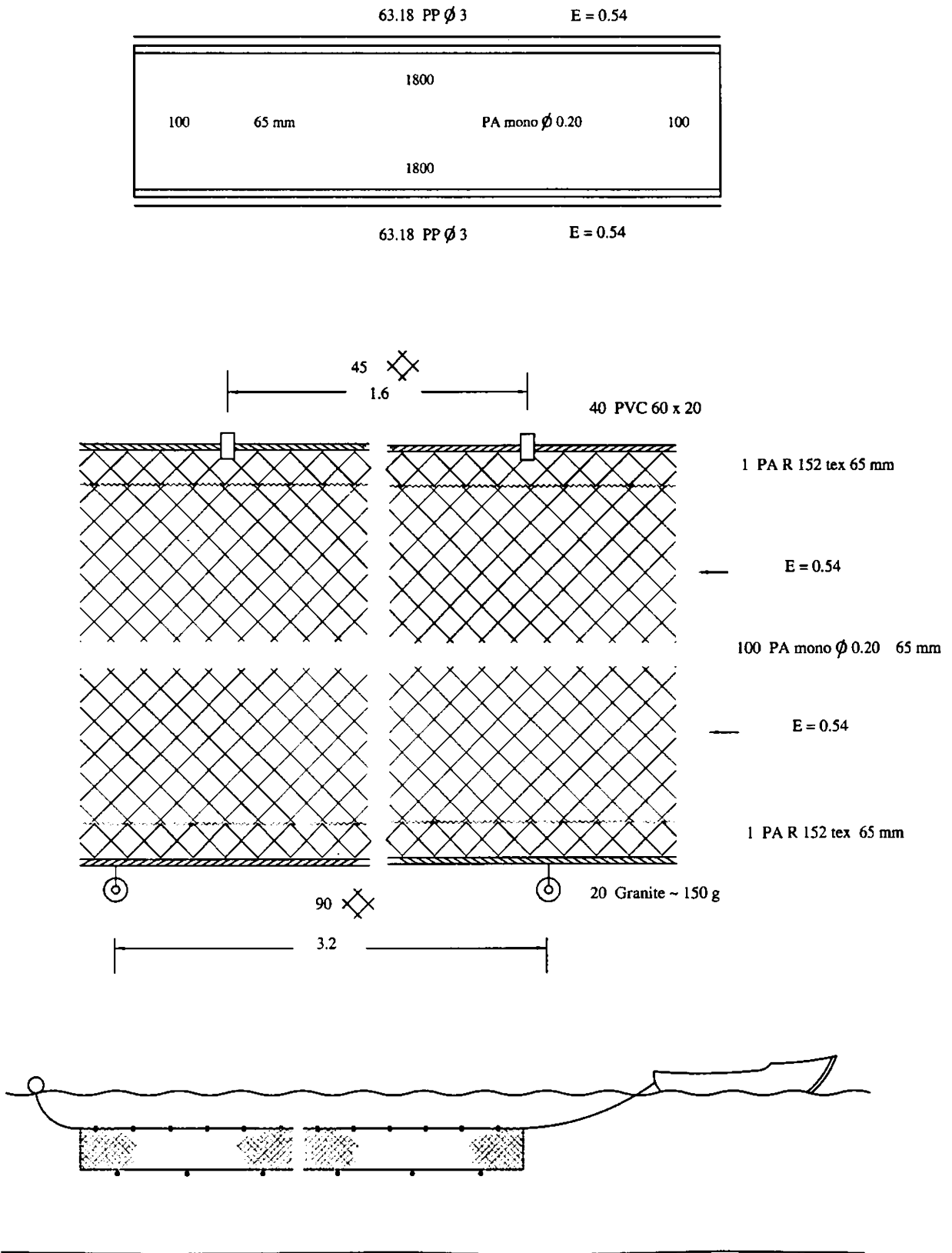


Fig 3.9. Design of gill net - Polynemus

GILL NET  
SEER  
(THALIKULAM, THRISSUR)

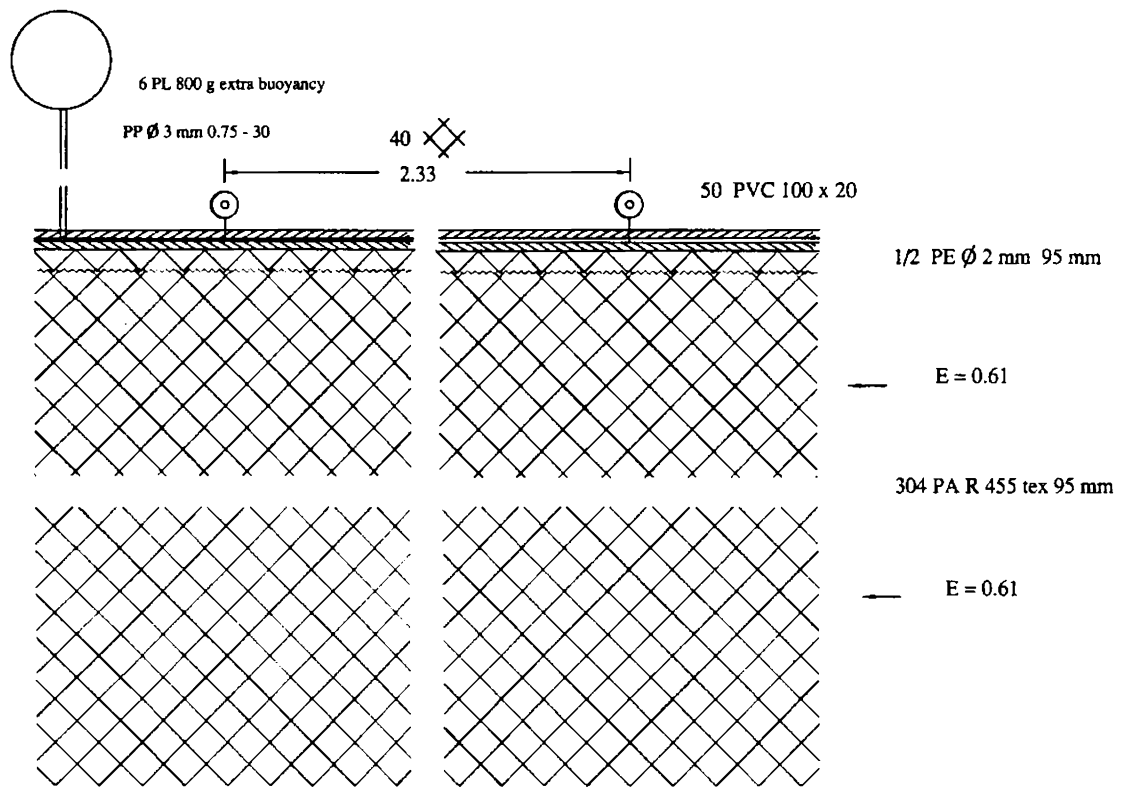
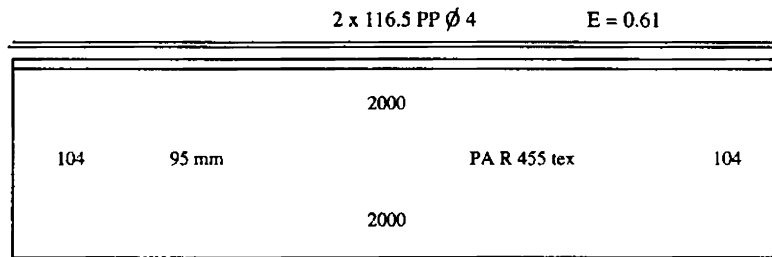


Fig 3.10. Design of gill net - Seer & Tuna

GILL NET  
POMFRET  
(CHAVAKKAD)

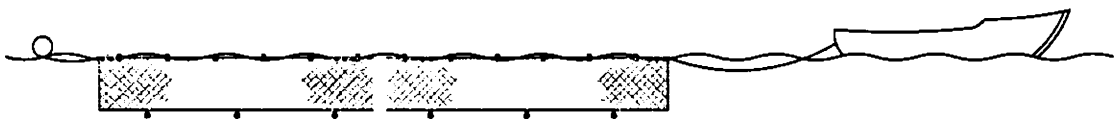
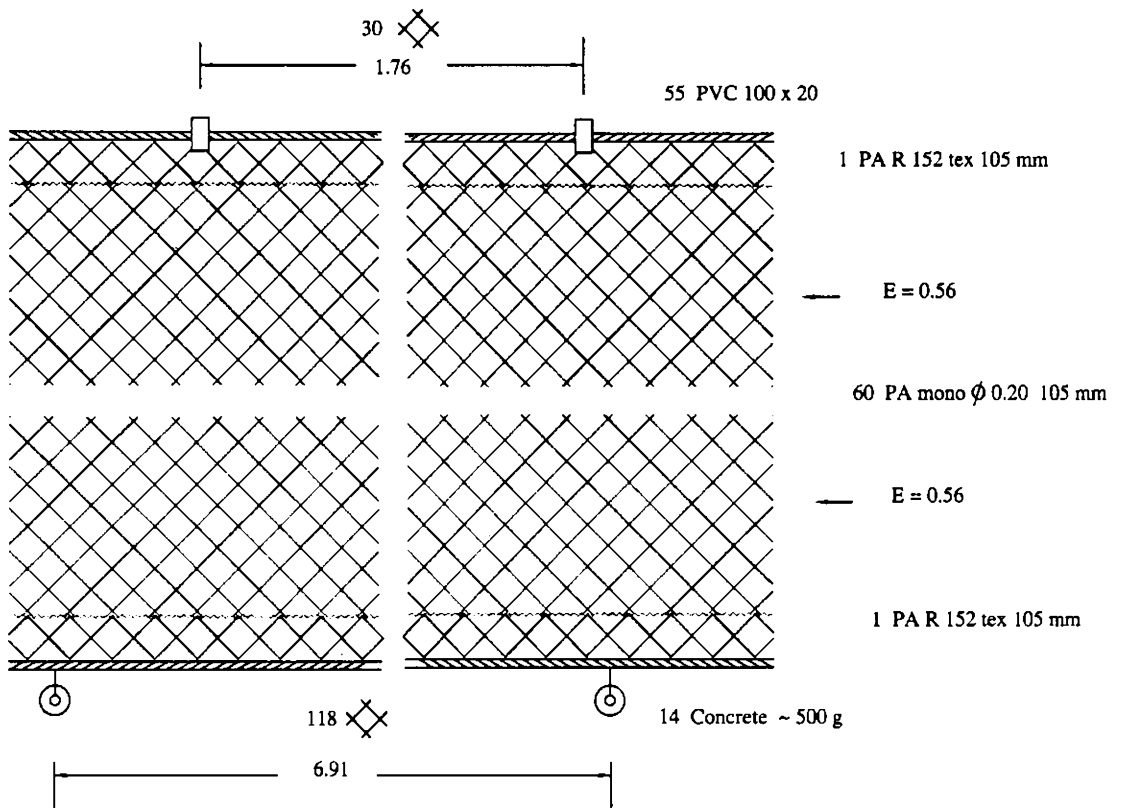
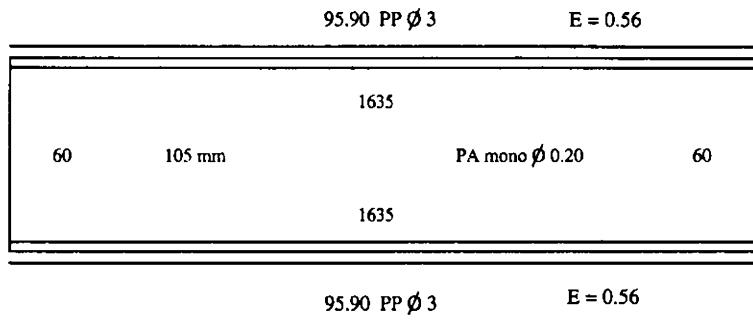


Fig 3.11. Design of gill net - Pomfret

GILL NET  
SHARK  
(THALIKULAM, THEISSUR)

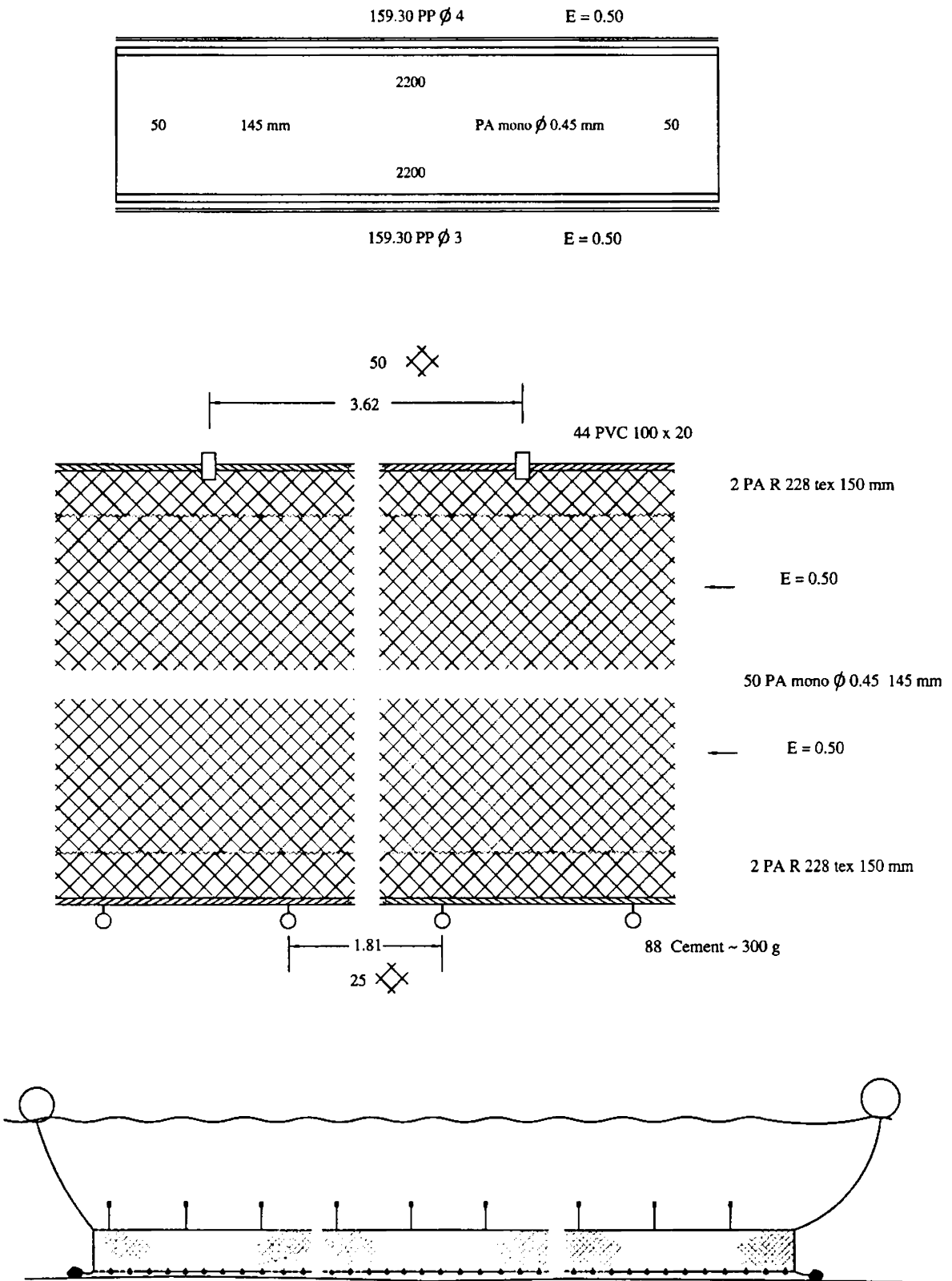


Fig 3.12. Design of gill net - Shark

GILL NET  
LOBSTER  
IRAVIPURAM (KOLLAM)

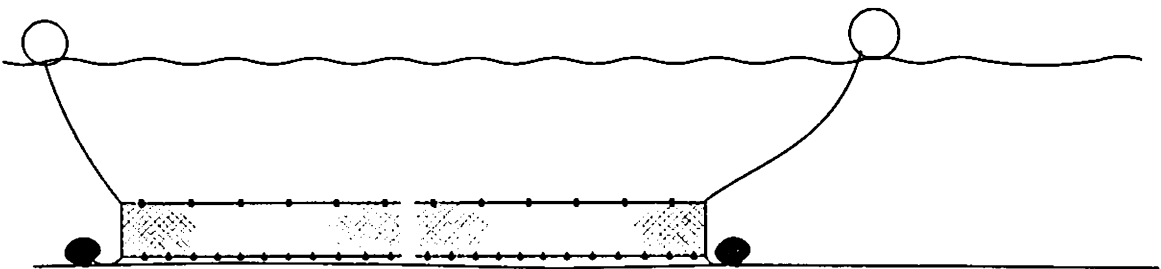
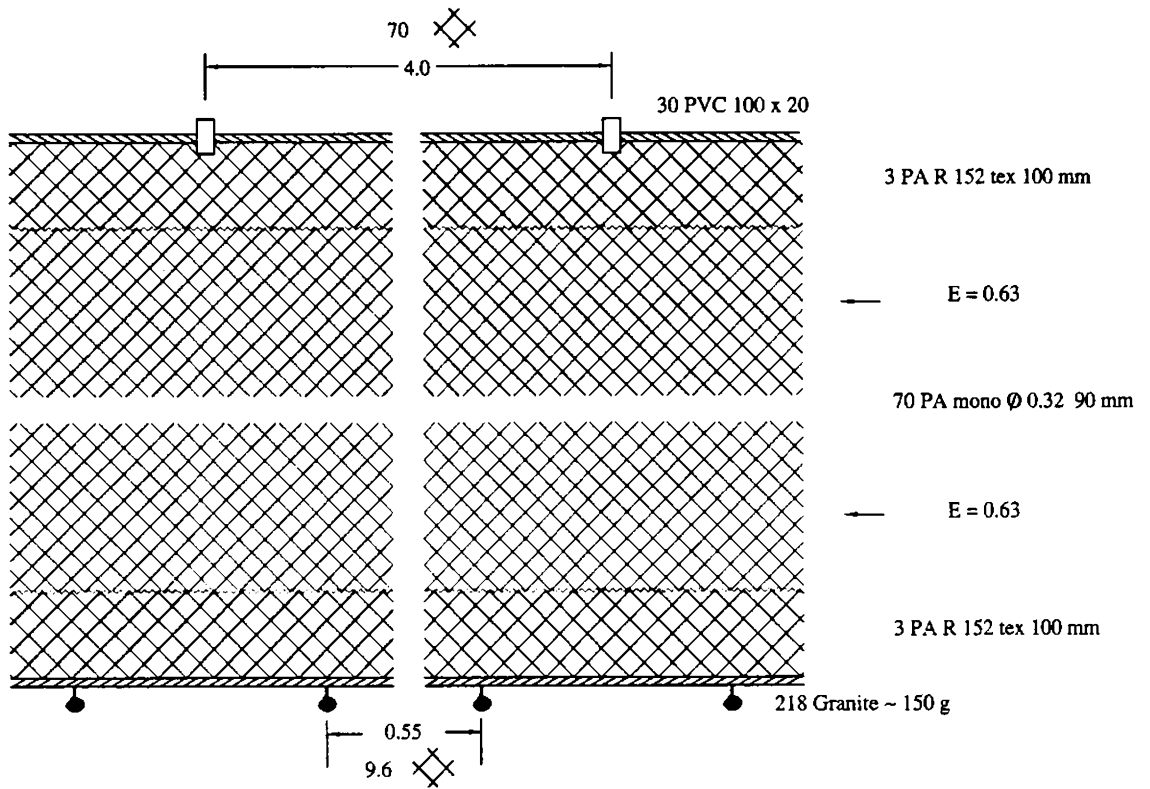
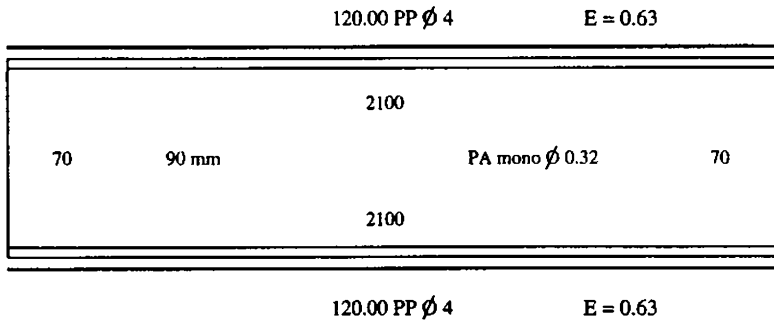
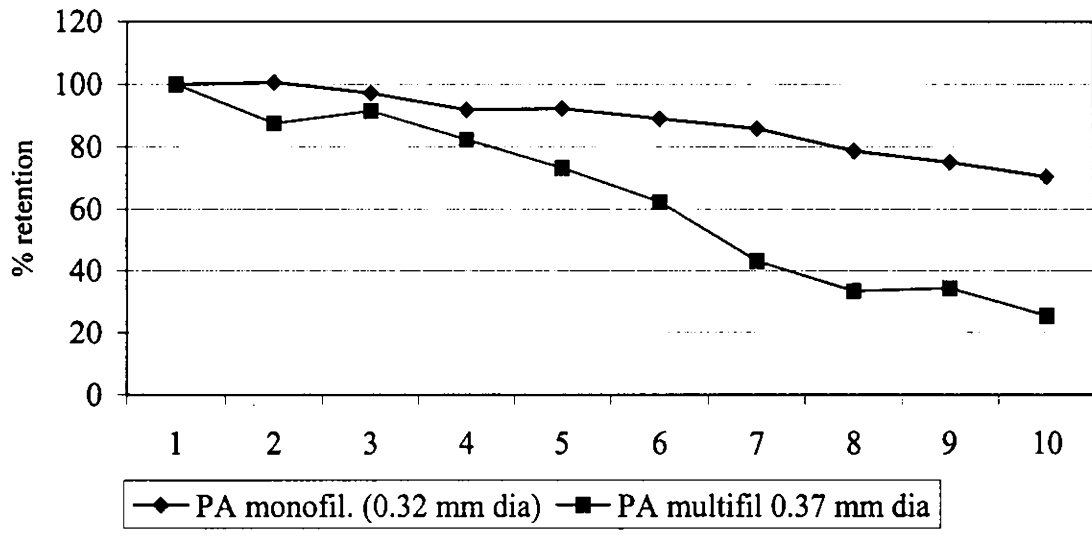
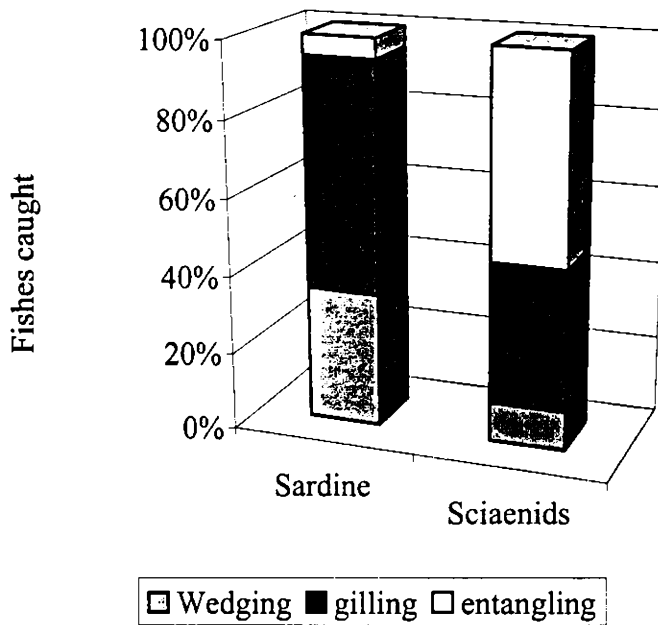


Fig 3.13. Design of gill net - Lobster

**Fig. 3.14. Loss in breaking strength of materials exposed to sunlight**



**Fig. 3.15. Mode of capture of fishes**



## **Chapter 4**

# **Photodegradation in Gill Net Materials**



## Chapter 4

### PHOTODEGRADATION IN GILL NET MATERIALS

#### 4.1. Introduction

Polyamide (PA) became the first synthetic material to replace cotton/hemp in India and its indigenous production started in 1962 (Meenakumari *et al.*, 1993). Radhalakshmi (1995) reported availability of PA in India as multifilament twisted and monofilament single. In the gill net sector, cotton was completely replaced by PA (Radhalakshmi *et al.*, 1993). Initially PA multifilament and later PA monofilament became popular. In the quest for better catching efficiency, fishermen started using thinner materials, as PA monofilament of 0.20 and 0.23 mm diameter were mostly in use earlier which was later replaced by 0.16 mm dia. The use of PA monofilament of 0.16 mm diameter in webbing necessitates frequent replacement as this lasts for 6 months to 1 year only.

The resistance to photodegradation can be considered as a basic property determining the durability of the material. Exposure to sunlight was known to have a degradation effect on most natural fibres and the problem has not been overcome with the development

of synthetic polymer materials. Carrothers (1957) reported that on an average, a well cared for PA net loses about 25 % of its strength during the first season and another 10 % during the second season. Sun light was considered to be the most important element in weathering and the strongest deterioration effect was caused by the ultra violet part of the sun's radiation followed by temperature and oxygen (Daruwalla, 1967 and Rugger, 1968). The near- ultraviolet light reaching the earth, although comprising only 5 % of the total spectral distribution, gives more energy or photon than does visible light (Dupont, 1967).

Weathering causes modification and breakdown of molecular structure of polymers, which in turn results in the loss of strength, extensibility, general durability and appearance. When conducting weathering and light exposure tests, breaking strength loss was commonly used as a measure of the amount of degradation (Egerton and Shah, 1968, Little and Parsons, 1967 and Singleton *et al.*, 1965).

Infra red spectroscopy, thermal and thermo-chemical analyses were the analytical methods usually employed to set important information about a polymer's chemical structure. The oxidation of polymer was determined primarily by the rates of diffusion and

absorption. In the aging of polymers, oxidation was a major process that leads to the creation of carbonyl groups in the polymer chain. Identification of carbonyl groups in polymers by infrared absorption spectroscopy was relatively simple because of the strong distinct absorption bands of the C=O vibrations. Other processes involve creation of hydroxyl groups and a variety of unsaturated bonds between carbons which can be identified by the analysis of the region of IR spectrum containing absorption bands for O-H and unsaturated bond vibrations. Infrared spectroscopy measurements thus provide supporting evidence to the polymer degradation, which results in the strength loss on exposure.

Test methods combining physical measurements to assess the changes in mechanical properties and analytical techniques to understand the degradation reaction are very important.

Weathering studies conducted in India on fish netting twines were confined to assessment of the strength loss by physical measurements only. Weather resistance of polyethylene and PA twines of different specifications were studied by Meenakumari *et al.*, (1985), Meenakumari and Ravindran (1985), Meenakumari and Radhalakshmi (1988) and Meenakumari *et al.*, (1995). With the

popularisation of PA monofilament recently, the assessment of its weathering resistance has become very important. Hence a study was taken up to assess the comparative weather resistance of PA monofilament, PA multifilament and HDPE monofilament twine.

#### **4.2. Materials and Methods**

The test samples comprised commercial samples of PA monofilament of four specifications 0.16 mm (Tex 23), 0.20 mm (Tex 44), 0.23 mm (Tex 50) and 0.32 mm (Tex 90) diameter, PA multifilament of five specifications 210dx1x2 (Rtex 51), 210 dx3x3 (Rtex 223), 210 dx6x3 (Rtex 455), 210 dx9x3 (Rtex 683) and 210 dx12x3 (Rtex 911) and PE twisted monofilament of two specifications 1.25 mm (Rtex 620) and 1.5 mm (Rtex 934) diameter conforming to Indian standard specifications (IS: 4401, 1976 and IS: 6347, 1971). The test samples were suspended without tension on aluminium nails set 1 cm apart on a rectangular wooden frame unbacked to provide ventilation and to prevent temperature from building up. The mounted samples were kept in north south direction at an angle of  $45^{\circ}$  on the rooftop where sunlight falls directly on the samples during the whole day. Marine atmosphere conditions prevailed at the test site at Willington island, Cochin. The month wise amount of noon radiation during the

exposure period was recorded by a solar collector (model SE-MSR 3003A36 designed by Sunshine International to measure global radiation in the wave length ranging from 0.3 to 3 micrometer) installed by the Atmospheric Science Department of Cochin University of Science and Technology. The sub-samples from the test samples were removed for measuring the change in strength after 8, 15, 30, 45, 60, 90, 120, 150 and 180 days of exposure. The exposure was made during December 1998 to May 1999, when almost continuous sunshine, occurred at the test site. The retrieved samples and the unexposed control samples were tested for breaking strength and extension on a Universal Testing Machine (UTM) of model ZWICK 1484 in accordance with IS: 5815 (Part IV): 1971. Ten replicates of each sample were tested and the average value was taken. Breaking strength rather than tenacity was utilized as the index of degradation in order to eliminate variations in denier arising from minor shrinkage or stretch during the exposure.

Retention of strength was calculated by comparing with the average strength retained by an unexposed control sample. The loss in strength in terms of original was calculated, based on the consideration that the material loses its serviceability when 50 % reduction occurs in its original strength (Brandt, 1959).

The degradation of polymer structure by extensive service (exposure to weather) was assessed by infrared spectroscopy. The samples after exposure outdoor for 180 days were analysed along with unexposed control samples using FTIR spectrometer of model Nicolet Avatar 360 ESP with following conditions.

Scan	: 50
Detector	: Duterium triglyceryl sulphide
Beam splitter	: Potassium bromide

### **4.3. Results and Discussion**

#### **4.3.1. Assessment of Mechanical Strength Properties**

##### **4.3.1.1. Loss in Mechanical Strength Properties**

The specifications and physical properties of the samples tested are given in Table 4.1. The breaking strength and extension at break of samples for different periods of exposure are given in Table 4.2. In all the three materials, there was loss in mechanical strength properties i.e. breaking strength as well as extension at break.

PA monofilament on an average retained 72.9 % of the breaking strength at the end of 180 days whereas PA multifilament retained only 41.7 % and PE 61.8 % (Fig.4.1). The extension of the

samples also showed reduction. PA monofilament on an average retained 57.8 %, PA multifilament retained 53.2 % and PE retained 56.1 % of the extension at the end of 180 days of exposure (Fig.4.2).

The course of deterioration correlating retained strength/extension in % (Y) and period of exposure (X) showed that the degradation leading to loss in strength and extension was significantly linear indicating that the process was continuous for the three materials viz., PA monofilament, PA multifilament and PE (Fig.4.3). The correlation coefficients for strength were 0.9621, 0.9607 and 0.9347 respectively for PA monofilament, PA multifilament and PE monofilament. The coefficients for extension were 0.8631, 0.8736 and 0.9285. The linear relationship of rate of deterioration and exposure period was in conformity with the observations of Meenakumari and Radhalakshmi (1988).

To find out whether there was any significant difference between the three types of materials and periods of exposure in terms of retention in strength and extension, the analysis of variance (ANOVA) was employed. Results showed significant difference between materials and periods of exposure in terms of retention of strength and extension. In the case of retention of strength, there was

significant difference between periods of exposure,  $P < 0.001$  ( $F=37.14$ ,  $df\ 9,18$ ) and between materials,  $P < 0.001$  ( $F= 17.16$ ,  $df\ 2, 18$ ). In the case of retention of extension also there was significant difference between periods,  $P < 0.001$  ( $F=41.921$ ,  $df\ 9,18$ ) and between materials,  $P < 0.05$  ( $F = 6.278$ ,  $df\ 2, 18$ ).

The difference in retention of strength between periods of exposure can be due to the difference in the weather conditions during different seasons of the year. The month wise amount of noon radiation, maximum temperature and precipitation during the exposure period given in Table 4.3 showed difference between months. Inderfurth (1953) reported that deterioration due to weathering was more rapid at certain locations than others, because of difference in duration of that particular wavelength of light, which damages the fibre. The degradation was dependent upon several factors such as the intensity of UV radiation, relative humidity and temperature.

The difference in retention of strength and extension between materials can be due to the difference in the chemical structure of the material. Resistance to light and weathering was the same in all-vegetable fibres while synthetic fibres showed very great difference



in their degree of resistance to light and weathering (Klust, 1959). Molin (1959) reported that one of the disadvantages of PA nets for fishing purpose was their relatively high sensitivity to ultraviolet rays. Multifilament was most sensitive to such radiation and monofilament was more resistant. PA exposed continuously to sunlight of normal intensity for 2 months could lose as much as 40 % of its tensile strength and a twine of PA staple without protection when hung in sunlight may lose strength up to 75 % in the first 3 months (Rummler, 1954) and must therefore be kept away from sunlight. Alsayes *et al.*, (1996) also observed higher degradation effect of ultraviolet light on multifilament material than that of monofilament.

The retained values for the breaking strength and extension showed that PA multifilament was more susceptible to weathering than monofilaments of PA and PE. To confirm the greater susceptibility of multifilament to weathering, retention of strength of PA monofilament and multifilament ~~the rate of deterioration in~~ samples of comparable thickness were compared. It was seen that PA multifilament of 210dx1x2 (0.37 mm dia) retained only 25.31 % of the breaking strength while PA monofilament of 0.32 mm dia retained 70.43 % (Fig. 4.4). A comparison of PE and PA

multifilament also showed similar results. PE twisted monofilament of 1.50 mm diameter retained 88.60 % of breaking strength while PA multifilament of 210dx12x3 (1.54 mm dia) retained only 51.69 % strength (Fig.4.5). Thus it was confirmed that PA multifilament was the most susceptible to weathering among the three materials exposed outdoor.

The index for assessing the service life of fishing net twine was the 50 % retention of strength or extension (Brandt, 1959). In monofilament, all the samples viz., 0.16, 0.20, 0.23 and 0.32 mm diameter, retained breaking strength and extension above 50 % levels of the original after 180 days exposure. In multifilament, only 3x3 and 12x3 samples retained 50 % strength. In PE, sample of 1.25 mm diameter retained less than 50 % strength whereas sample of 1.5 mm diameter retained above 50 % of strength and extension.

These findings showed that monofilament is superior to multifilament with regard to resistance to weathering. As PE twine was made of monofilament yarn it can withstand weathering better than PA multifilament (Mukundan and Narayanan, 1975). However the initial high breaking strength of PA makes it possible to remain superior to PE in strength after exposure for a certain period.

#### **4.3.1.2. Effect of Thickness of Material on Degradation**

The effect of weathering also depends on the thickness of the netting yarns. The ratio of surface to mass is very important. The samples of each material were analysed separately to find out differences if any in the course of deterioration in properties with respect to thickness of the material.

##### **4.3.1.2.1. PA monofilament.**

Fig.4.6 shows the retention in strength of each sample of PA monofilament at specific periods of exposure. The maximum strength loss was for the thinnest sample 0.16 mm diameter and it decreased progressively with the increase in thickness of the sample. The loss in strength at the end of 180 days of exposure was 47.23, 36.64, 29.57 and 28.36 % for 0.16, 0.20, 0.23 and 0.32 mm diameter respectively (Table 4.2). Fig. 4. 7 shows the retention in extension of different PA monofilament samples at specific periods of exposure. The maximum reduction in extension also was for the thinnest sample 0.16-mm diameter. The loss in extension at the end of 180 days of exposure was 52.69, 39.08, 36.59 and 40.59 % for 0.16, 0.20, 0.23 and 0.32 mm diameter respectively (Table 4.2.). Fig. 4.8 represents the course of degradation in breaking strength and extension at break, of

samples. The correlation coefficients ( $r^2$ ) for retention of strength ranged between 0.9111 and 0.9829 and that for retention of extension ranged between 0.7414 to 0.8657. The high  $r^2$  indicated a significantly 'linear' progress in deterioration of mechanical properties on exposure. In all cases the rate of deterioration of extension was greater than the strength.

#### **4.3.1.2.2. PA multifilament**

In the case of PA multifilament also, the loss in breaking strength and extension showed a more or less progressive decrease in relation to the increase in thickness of the samples except 210 d 3x3 (Fig.4.9, 4.10). The loss in strength after 180 days was 74.69, 25.92, 54.85, 63.48 and 48.31 % in samples viz., 210 d 1x2, 210 d 3x3, 210 d 6x3, 210 d 9x3 and 210 d 12x3 respectively (Table 4.2). The reduction of extension in PA multifilament was 64.64, 40.37, 46.37, 49.22 and 33.52 % in samples viz., 210 d 1x2, 210 d 3x3, 210 d 6x3, 210 d 9x3 and 210 d 12x3 respectively (Table 4.2). The regression analysis of the retention of strength (Y) and exposure period (X) showed high  $r^2$  values. The  $r^2$  values for retention of strength ranged between 0.9157 and 0.9777 and for retention of extension ranged between 0.7954 and 0.9879 respectively (Fig. 4.11). The high  $r^2$

values indicated 'linear' progress in rate of deterioration. Equation  $Y = a + bx$  in all samples represents an inverse relationship between retention of strength/extension (Y) and exposure period (X).

#### **4.3.1.2.3. Polyethylene (PE)**

The retention of strength and extension of the two samples of PE at different periods of exposure was depicted in Fig. 4.12. The sample with 1.25 mm diameter had a loss of 65.89 % of breaking strength whereas 1.5 mm diameter had only 11.4 % loss of original strength (Table 4.2). In the case of retention of extension, sample with 1.25 mm diameter, had a loss of extension of 72.53 % whereas 1.5 mm diameter had only 15.29 % loss in original extension at break.

The relation between retention of strength (Y) and exposure period (X) was significantly linear. The  $r^2$  values for retention of strength and exposure period ranged between 0.8409 and 0.9165 (Fig. 4.13). However, in the case of retention of extension at break, the 'linear' regression was exhibited by the sample, 1.25 mm diameter only ( $r^2 = 0.9266$ ). The sample of 1.5 mm diameter did not follow a 'linear' progress in rate of deterioration of extension at break as  $r^2 = 0.3734$ . However, a polynomial regression was fitting to this sample

with  $r^2 = 0.5225$ . In both cases, the rate of deterioration of extension was greater than that of strength.

The results indicate that filament sizes and thickness affected the weather resistance. Fibres with high denier per filament were found to be more resistant than fibres with low denier per filament. Ede and Henstead (1964) indicated that thicker monofilament gave better resistance. The bigger the diameter the less noticeable is the photo degradation, which was insignificant for thicker ropes as the layers below were protected by the degraded outer surface. The degradation time of PP at 130°C was 65 hours for a film of 0.20 mm thickness and 225 hours for a sheet of 2.0 mm thickness (Gnatowski, 1993). Alsayes *et al.*, (1996) stated that thickness of material could be considered as a limiting factor for the ultra violet penetration and consequently the degree of photochemical degradation of such materials. The thicker the monofilament, the twine or the rope, the better, the resistance due to lesser in-depth penetration by ultra violet rays ( Radahlakshmi and Nayar, 1973). This could be explained by the fact that photo-oxidation was primarily a surface reaction, so the effect of UV radiation may not extend into the polymer bulk to a significant extent. Photo oxidation produces a variety of physical and chemical changes and the mechanical properties are deteriorated.

Weathering resistance studies using physical measurements can only show the difference in the relevant properties of various kinds of fibres. However, information relating to the degradation of polymer structure needs use of analytic methods such as infrared spectroscopy.

### 4.3.2. Assessment of Polymer Degradation by IR Spectroscopy

#### 4.3.2.1. Characteristic Absorbance of PE

FTIR spectrum of both unaged and aged (photo degraded) polyethylene showed the following characteristic absorbance (Fig. 4.14).

Characteristic absorbance of PE in control and degraded samples

Group	Undegraded	Degraded
C-C stretching	1430 cm <sup>-1</sup>	
C-H	1340cm <sup>-1</sup> (1374.97) cm <sup>-1</sup>	1373.99 cm <sup>-1</sup>
-CH2- deformation.	1485-1445cm <sup>-1</sup> (1444.95) cm <sup>-1</sup>	1465 cm <sup>-1</sup>
-CH3 (side chain branching)	1380-1370 cm <sup>-1</sup> (1374.97) cm <sup>-1</sup>	
Chromophoric/ Colour forming groups	3650-2500 cm <sup>-1</sup> (3200-2500)cm <sup>-1</sup>	
Appearance of carbonyl (C=O) groups (due to the oxidation of PE)		1725-1705cm <sup>-1</sup>

By examining the spectra of the degraded PE material it was observed that the peak at 1713 cm<sup>-1</sup> was characteristic absorbance of

carbonyl groups. This indicated that oxidation occurred in the PE molecules of the degraded material and hence the reduction in strength. The peak at  $1735\text{ cm}^{-1}$  was characteristic C=O stretching of carboxylic group. This also was due to the oxidation of PE ring. Early signs of PE aging were visible in the absorption band from  $1700$  to  $1800\text{ cm}^{-1}$  (Gnatowski, 1993).

The characteristic bands of aliphatic C-H stretching of  $\text{CH}_2$  groups were observed at  $2911.82\text{ cm}^{-1}$  and at  $1445\text{ cm}^{-1}$  and the former was very broad due to the influence of C=O stretching from pigments. After the exposure, the characteristic band of PE was centred at  $2839\text{ cm}^{-1}$  and  $1465\text{ cm}^{-1}$ . Further, the band  $1373\text{ cm}^{-1}$  became more intense and clear compared to the control. It showed that oxidation of  $\text{CH}_2\text{-CH}_2$  to  $\text{COOH}$  had occurred in the polymer. This was oxidative degradation of the PE molecule. The shifting second band at the finger point region from  $1445\text{ cm}^{-1}$  to  $1465\text{ cm}^{-1}$  implied definite breakage of band because of high energy of absorption due to fragmentation. There was a weak absorption at  $1165\text{ cm}^{-1}$  due to -OH deformation and stretching of  $\text{COOH}$  was more intense. Slight shifting towards higher wavelength implied that there was an oxidative degradation in polymeric chain. The broad band around  $3400\text{ cm}^{-1}$  was mainly due to carboxylic salts containing



water of crystallisation. This was in agreement with Gnatowski (1993), that the presence of a wide absorption band in the range from 3000 to 3700  $\text{cm}^{-1}$  can be due to the presence of hydroxyl groups. The intense peak of 721  $\text{cm}^{-1}$  also was from polyethylene's CH stretching of  $\text{CH}_2$  band.

Some polymers absorb UV radiation through groups in the normal structure, but quite frequently it was the presence of structural irregularities or associated impurities that were primarily UV absorbers. Cross-linking and chain scissions were the general reactions that take place. This often was accompanied by the formation of oxygen containing groups.

Polyethylene (PE) in its ideal structure should contain no groups capable of absorbing the UV radiation. But this polymer was much less stable than anticipated in view of the stability of its low molecular weight analogues. The instability of PE was due to the presence of traces of carbonyl and hydroperoxy groups formed during processing. Certain catalyst residues attached to the polymer molecules may also function as sites for UV absorption. In PE, initial reaction occurs at the carbonyl site in the polymer. Hydroperoxides were also formed by photo degradation of PE. Carbonyl groups

accumulate rapidly as effectively as hydroperoxides. Thus carbonyl groups appear to be primarily energy absorbers. They were considered as sensitizers for UV radiation

#### 4.3.2.2. Characteristic Absorbance of PA

FTIR spectrum of both unaged and aged (photo degraded) PA shows the following characteristic absorbance (Fig. 4.15, 4.16)

Characteristic absorbance of PA in control and degraded samples

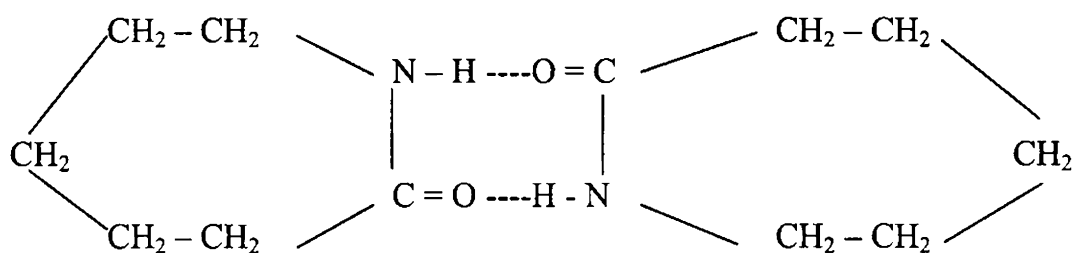
Group	Undegraded	Degraded
NH stretching vibration	3500 cm <sup>-1</sup>	
NH bending vibration	3400-3300 cm <sup>-1</sup>	(3298.2) cm <sup>-1</sup>
NH secondary free	3430 cm <sup>-1</sup>	
NH secondary bonds	3320-3140 cm <sup>-1</sup>	
NH bending vibration	1650-1590 cm <sup>-1</sup>	(1641.33) cm <sup>-1</sup>
For degraded PA ( <i>due to cyclic lactum formation</i> )		1750-1700 (1739.96) cm <sup>-1</sup>

In PA, absorption at 1739.96 cm<sup>-1</sup> clearly established the cyclic lactum formation. Apart from this, the free sharp peaks between 3550 cm<sup>-1</sup> to 3900 cm<sup>-1</sup> implied the presence of OH moiety in the degraded PA.

Amides showed two absorption bands around 1600-1700 cm<sup>-1</sup> corresponding to C = O stretching and N - H deformation, but

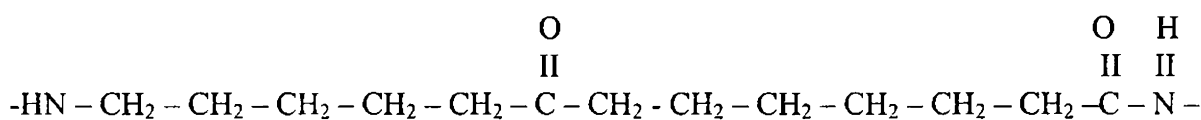
because of vibrational coupling the original character of the vibrations were modified. The two bands were not C = O structure and N – H deformation and were usually referred to as the amide I and amide II bands. Amide I may be as high as 80 % C = O structure in character, but amide II a strongly coupled interaction between N-H deformation and C – N structure.

In caprolactam there was a possibility of inter molecular hydrogen bonding. The bands at 3550 – 3700 cm<sup>-1</sup> may be due to the N – H stretching.

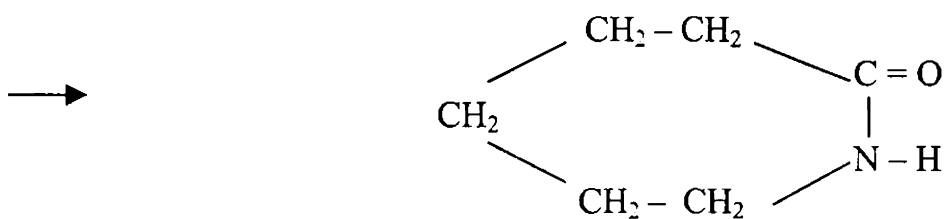


From the above there was a clear evidence of breakage of bonds between

O  
 II  
 -C -N - H and undergo cyclisation resulting formation of caprolactam

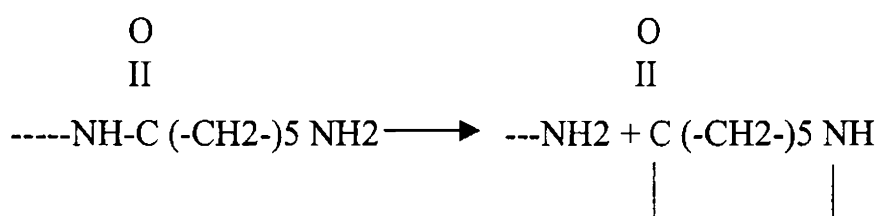


PA – 6



Caprolactam

In polyamides, random scissions of bonds occur along the backbone chain due to photodegradation in the presence of moisture. Hydrolysis may be catalysed by acids, bases or additional catalysts that may form within the polymer as a result of oxidative degradation / photo degradation. Water first absorbed at the surface of the polymer, penetrated into the subsurface region. Hydrolysis mainly occurs at the amorphous region, which were more readily penetrated by water molecules. As a result of hydrolytic instability of PA lower molecular weight polymers were formed in addition to the monomer units. In PA, monomer units were formed by the back-biting mechanism.



Thus the IR spectroscopic measurements of the exposed samples provide supporting evidence to the polymer degradation which resulted in the strength loss. In PE occurrence of oxidation and

the characteristic C – O stretching of carbonyl group were evidence of change in polymer structure due to photo-oxidation. In PA also the cyclic lactam formation and the presence of OH, point out degradation of polymer.

**Table 4.1. Specifications and physical properties of samples studied.**

Sl. No.	Specification		Weight/m (g)	Rtex	Strength (N)	Extension at break (%)
	Type	Diameter (mm)				
1	PA monofilament	0.16	0.036	23	14.82	27.73
2	PA monofilament	0.20	0.044	44	16.35	34.67
3	PA monofilament	0.23	0.047	50	21.66	32.8
4	PA monofilament	0.32	0.050	90	36.25	35.06
5	210dX1X2	0.37	0.053	51	26.59	27.12
6	210dX3X3	0.75	0.237	223	71.26	35.42
7	210dX6X3	1.04	0.483	455	210.7	39.9
8	210dX9X3	1.30	0.725	683	312.4	35.82
9	210dX12X3	1.54	0.98	911	513.86	34.25
10	PE twisted monofilament	1.25	0.629	620	217.8	22.21
11	PE twisted monofilament	1.50	0.847	934	278.08	29.56

**Table 4.2. Breaking strength and extension of materials after exposure to sunlight**

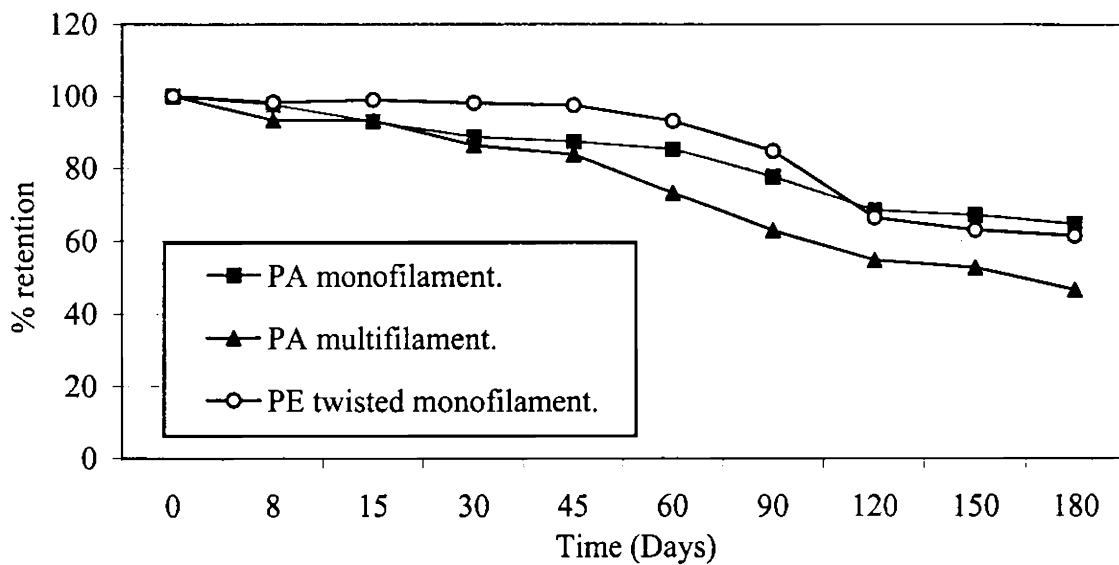
<b>(a) PA monofilament</b>										
Days	0.16 mm dia		0.2 mm dia		0.23 mm dia		0.32 mm dia			
	Strength (N)	Ext (%)	Strength (N)	Ext (%)	Strength (N)	Ext (%)	Strength (N)	Ext (%)		
0	14.82	27.73	16.35	34.67	21.66	32.80	36.25	35.06		
8	14.71	26.26	15.78	31.03	20.34	27.20	36.46	34.51		
15	13.49	22.89	14.76	28.82	20.18	31.30	35.19	32.67		
30	12.38	20.86	14.66	27.3	19.32	24.60	33.28	29.66		
45	11.79	19.85	14.26	25.36	19.57	27.30	33.41	28.93		
60	11.57	19.6	13.94	23.43	19.16	27.00	32.24	25.06		
90	10.20	18.42	12.00	21.21	17.79	25.30	31.09	26.07		
120	8.56	16.46	10.92	20.89	15.34	22.30	28.50	23.77		
150	8.16	16.89	10.54	21.02	16.01	22.60	27.22	24.05		
180	7.82	13.12	10.36	21.12	15.52	20.8	25.53	20.83		
<b>(b) PA multifilament</b>										
Days	210 d x 1x2		210 d x 3x3		210 d x 6x3		210 d x 9x3		210 d x 12x3	
	Strength (N)	Ext (%)	Strength (N)	Ext (%)	Strength (N)	Ext (%)	Strength (N)	Ext (%)	Strength (N)	Ext (%)
0	26.59	27.12	71.26	35.42	210.70	39.90	312.40	35.82	513.86	34.25
8	23.27	23.27	71.01	32.94	190.00	36.90	287.80	32.44	497.79	34.90
15	24.31	23.25	70.90	32.93	192.80	32.90	280.00	28.23	482.46	33.23
30	21.88	19.83	68.58	29.87	171.50	31.00	271.10	28.58	434.15	28.67
45	19.47	16.89	66.46	27.67	171.30	29.00	255.30	26.56	457.42	31.03
60	16.54	16.43	66.54	27.31	159.80	32.30	204.00	22.81	353.10	24.07
90	11.46	12.69	60.27	23.22	131.20	23.30	174.10	19.34	352.40	26.48
120	8.89	11.24	56.74	22.01	115.80	24.30	135.40	16.55	321.07	23.91
150	9.12	12.62	53.40	20.83	120.30	24.00	119.30	19.90	302.85	22.50
180	6.73	9.59	52.79	21.12	95.14	21.40	114.10	18.19	265.63	22.77
<b>(c) PE twisted monofilament</b>										
Days	1.25 mm diameter				1.5 mm diameter					
	Strength (N)		Extension (%)		Strength (N)		Extension (%)			
0	217.80		22.21		278.08		29.56			
8	217.69		20.85		268.60		26.43			
15	216.97		21.00		273.25		27.96			
30	212.60		19.00		273.68		26.96			
45	211.67		21.69		271.42		26.10			
60	199.16		16.33		263.04		25.24			
90	157.94		13.90		268.91		26.37			
120	83.67		7.23		262.83		24.90			
150	75.41		6.42		254.08		26.95			
180	74.30		6.10		246.37		25.04			

**Table 4.3. Average noon radiation and total precipitation at the test site**

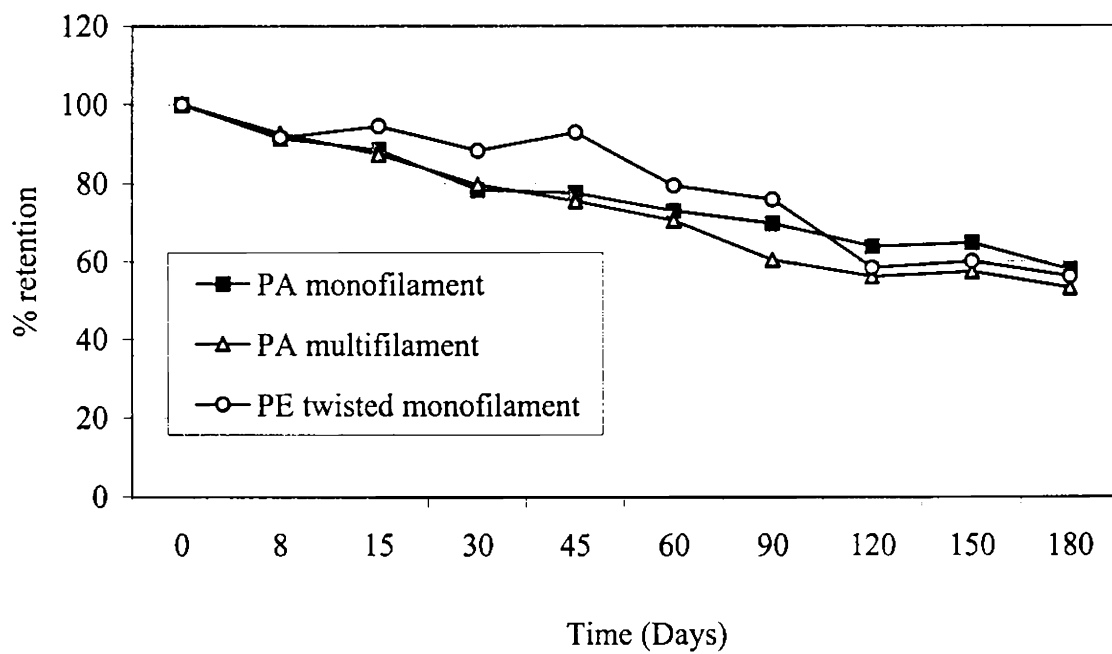
Month	Year	Exposure time (Days)	Radiation ( $W/m^2$ )	Maximum Temperature $^{\circ}C$	Total Precipitation (mm)
December	1998	8 , 15, 30	98	31.0	42
January	1999	45, 60	112	31.6	0
February	1999	90	154	32.9	12
March	1999	120	108	32.7	44
April	1999	150	91	31.9	143
May	1999	180	96	29.7	503



**Fig. 4.1. Changes in breaking strength in materials exposed to sunlight**



**Fig. 4.2. Changes in extension in materials exposed to sunlight**



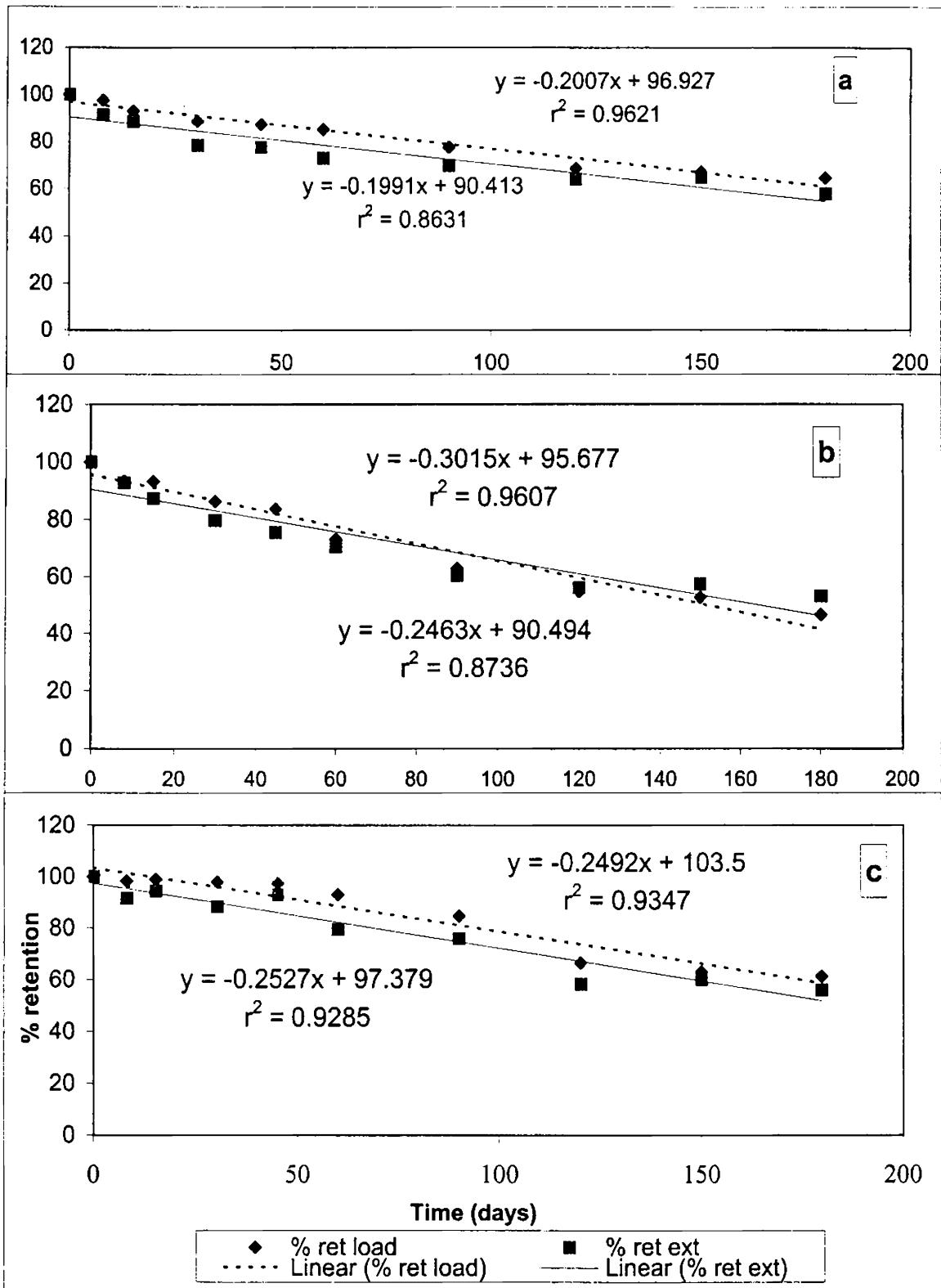


Fig. 4.3. Course of deterioration in mechanical properties  
 (a) PA monofilament (b) PA multifilament © PE monofilament

Fig. 4.4. Changes in breaking strength in PA monofilament and PA multifilament

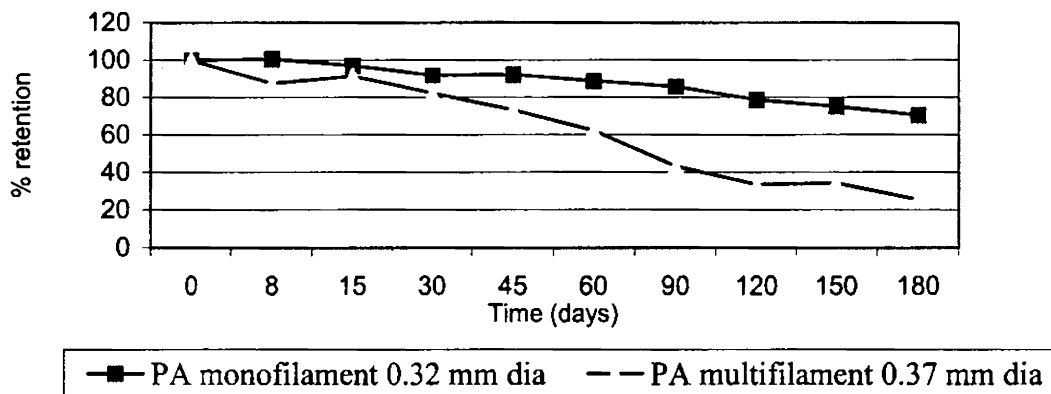


Fig.4.5. Changes in breaking strength in PA multifilament and PE monofilament

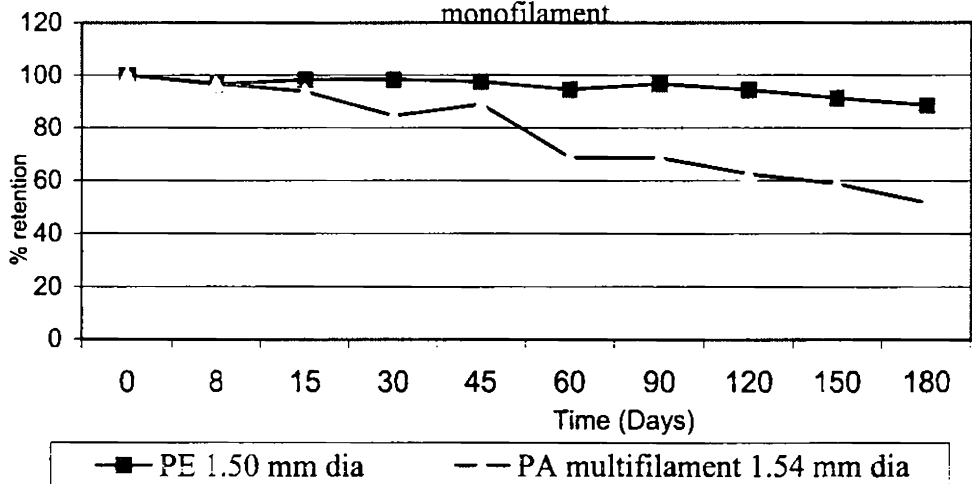


Fig. 4.6. Change in breaking strength in PA monofilament exposed to sunlight

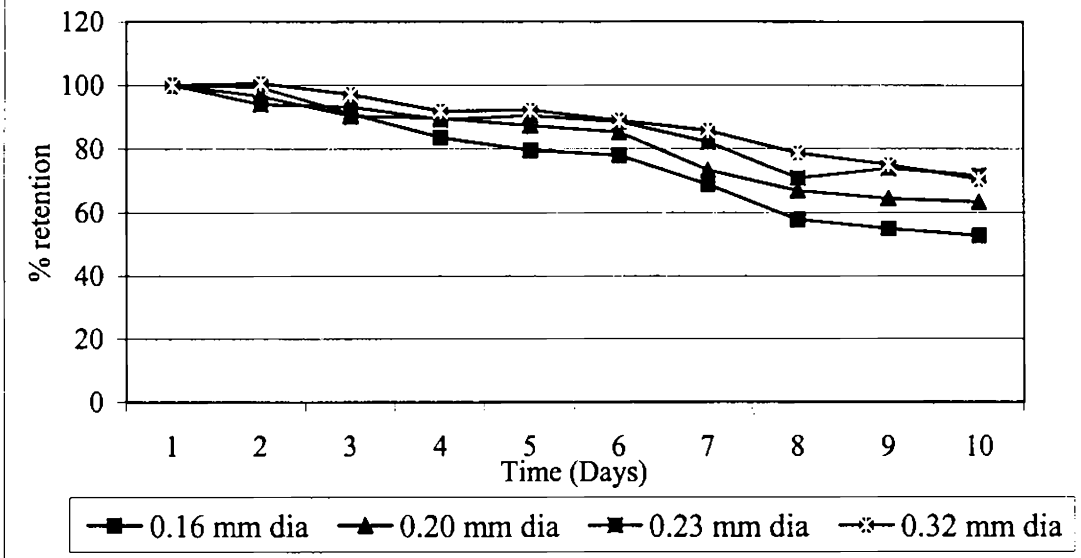
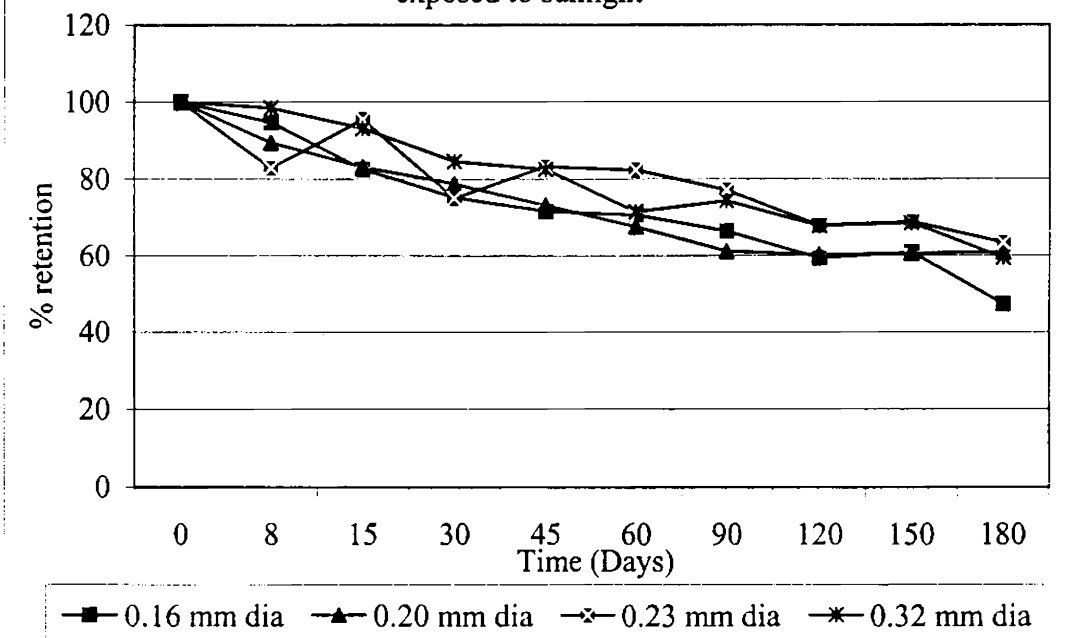


Fig. 4.7. Change in extension in PA monofilament exposed to sunlight



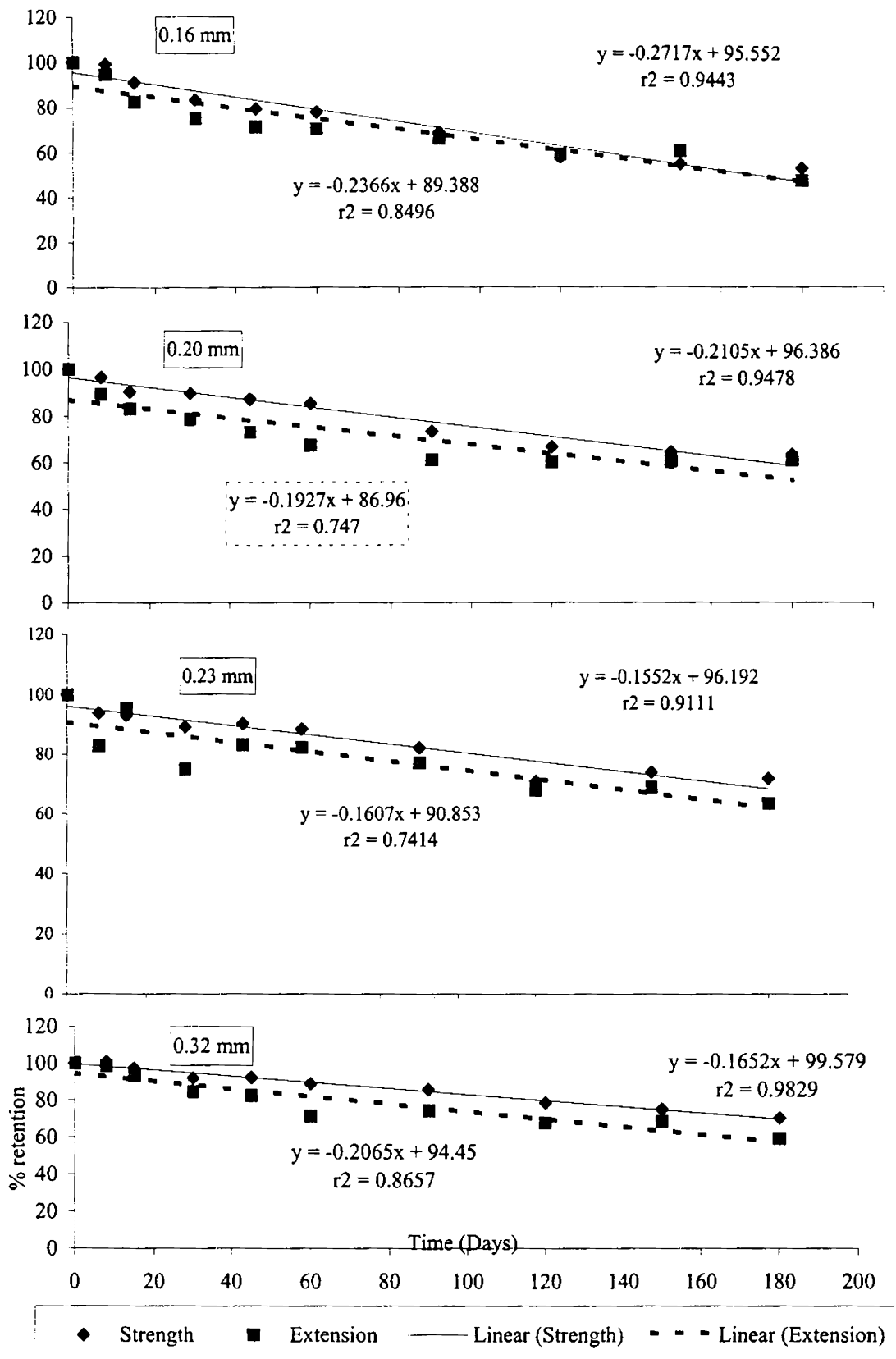


Fig. 4. 8. Course of deterioration of PA monofilament fibres on outdoor exposure

Fig. 4.9 Change in breaking strength in PA multifilament samples exposed to sunlight

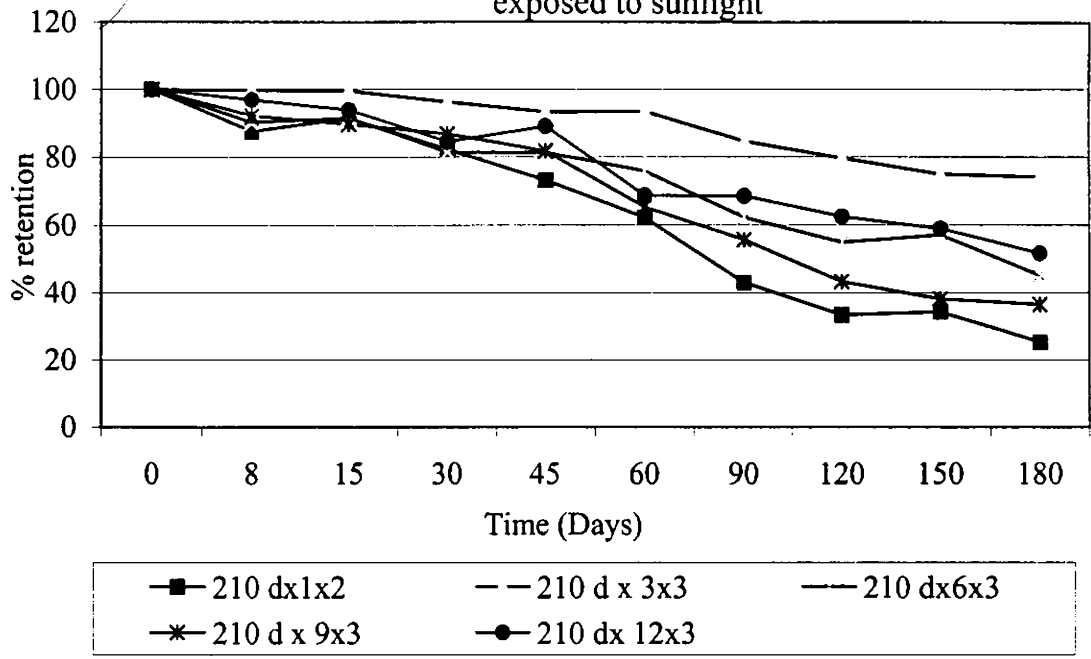
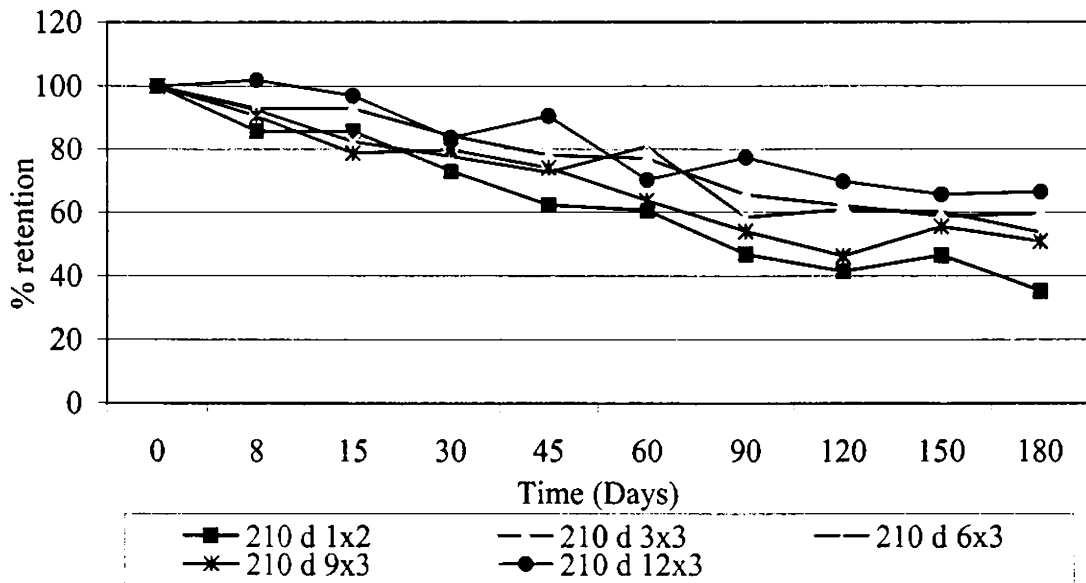


Fig. 4.10. Change in extension in PA multifilament samples exposed to sunlight



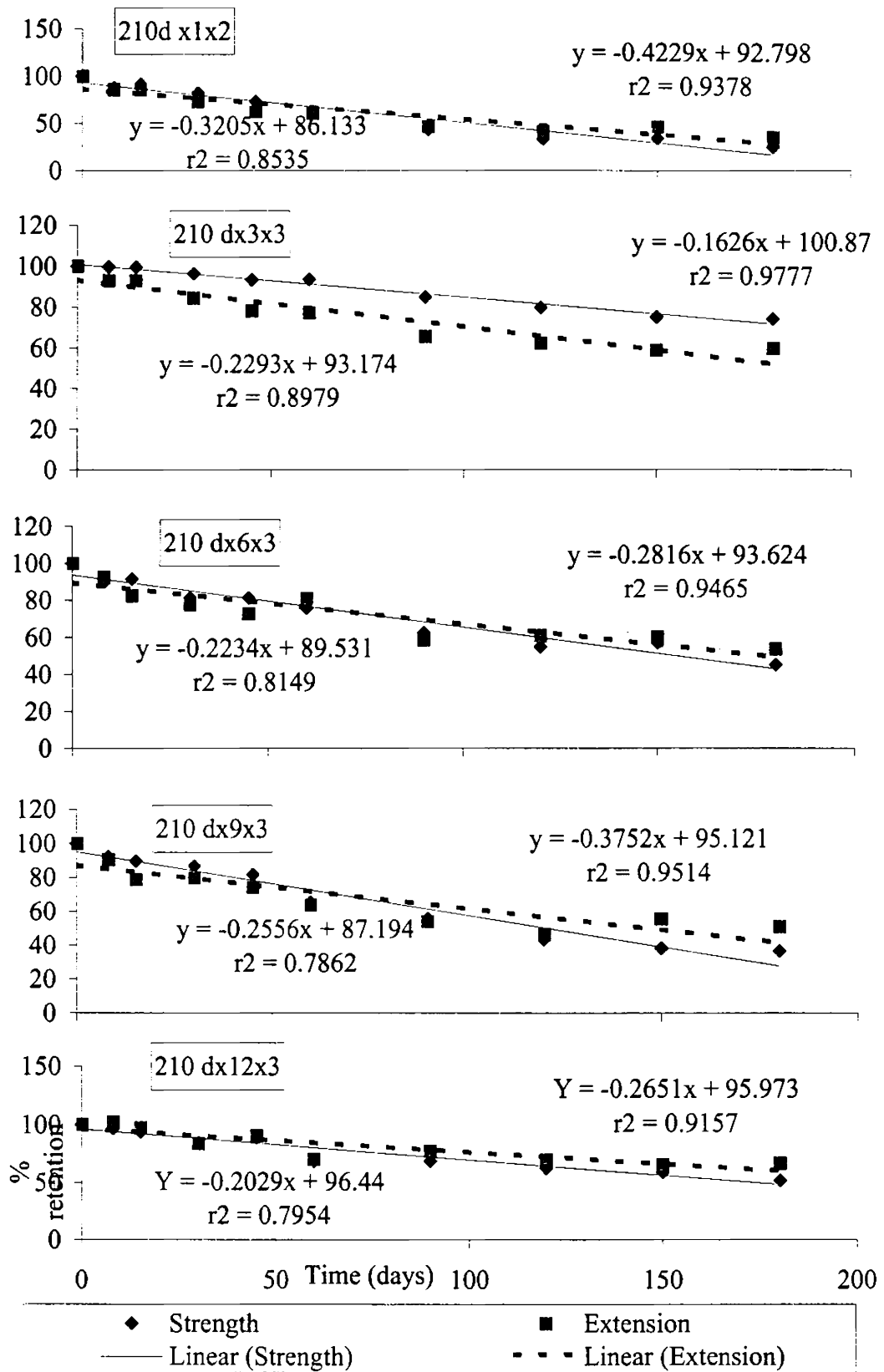
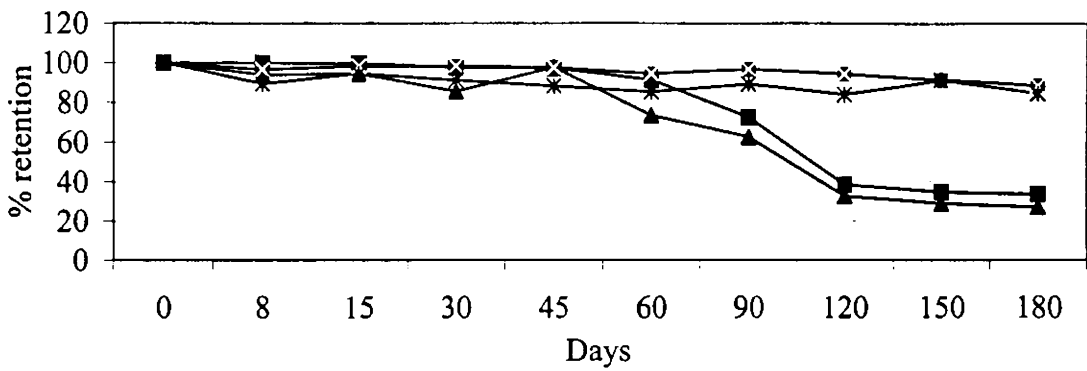
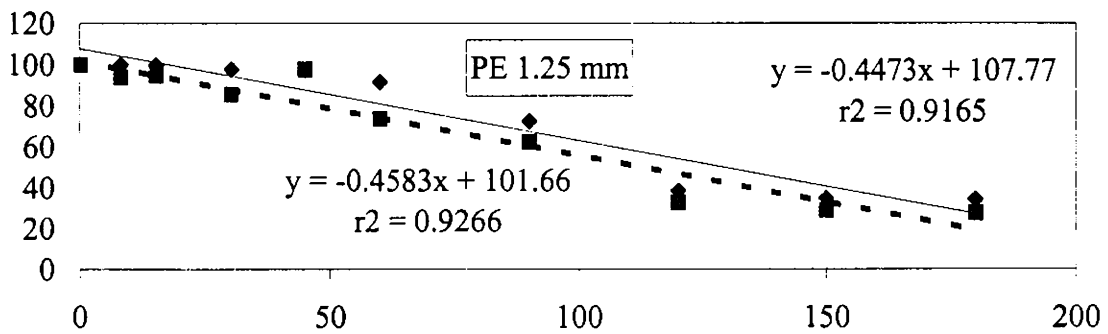


Fig. 4.11. Course of deterioration of PA multifilament exposed to sunlight

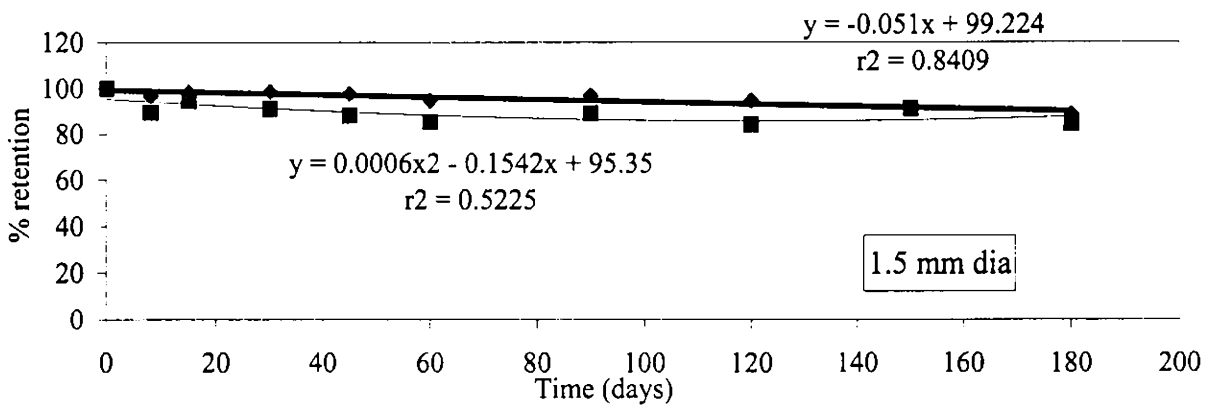
Fig.4.12.Change in strength of PE monofilament exposed to sunlight



- 1.25 mm br. strength
- ▲ 1.25 mm dia extension
- ✕ 1.50 mm dia br. strength
- \* 1.50 mm dia extension



- ◆ Strength
- Extension
- Linear (Strength)
- - - Linear (Extension)

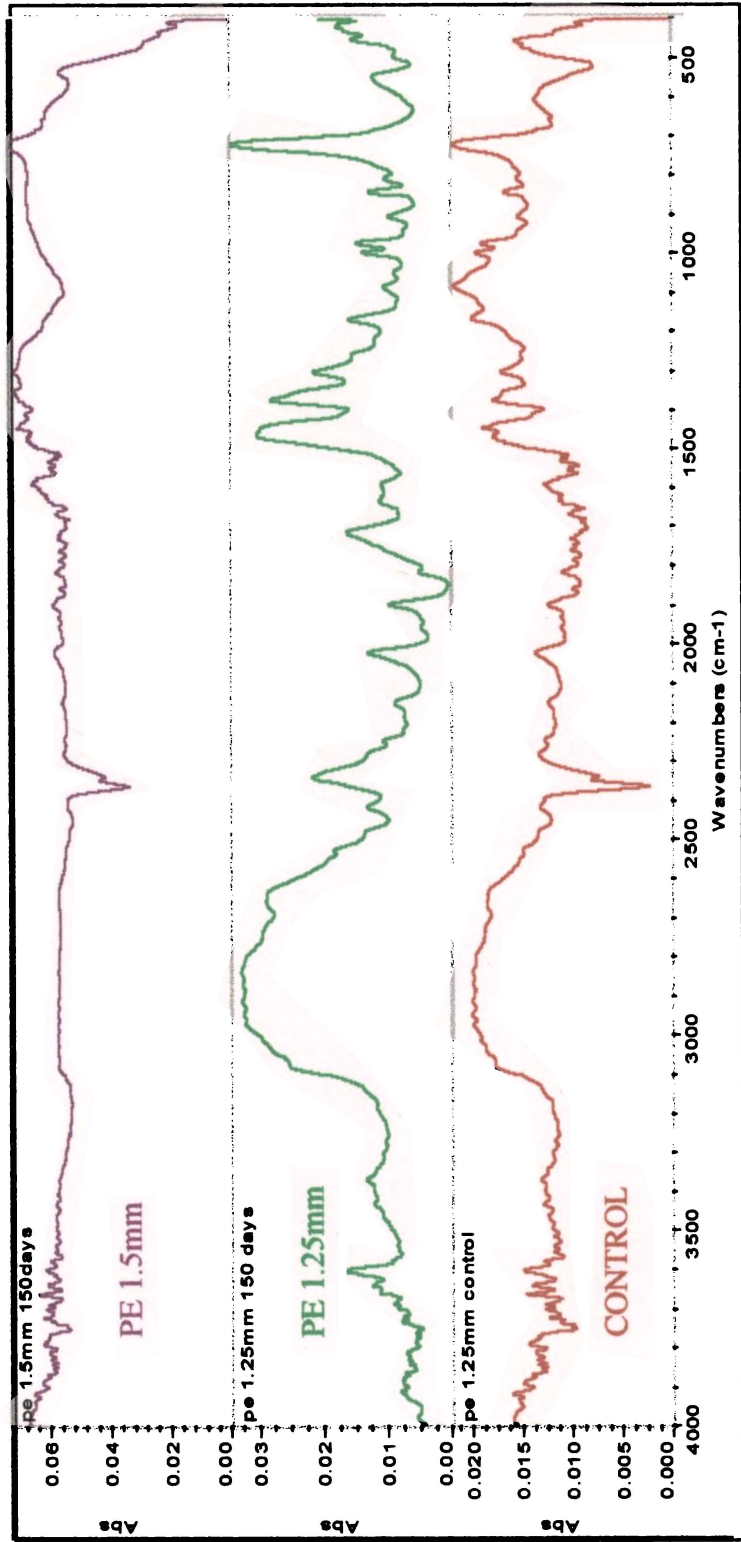


- ◆ Strength
- Extension
- Linear (Strength)
- ..... Poly. (Extension)

Fig. 4.13. Course of deterioration in PE monofilament exposed to sunlight

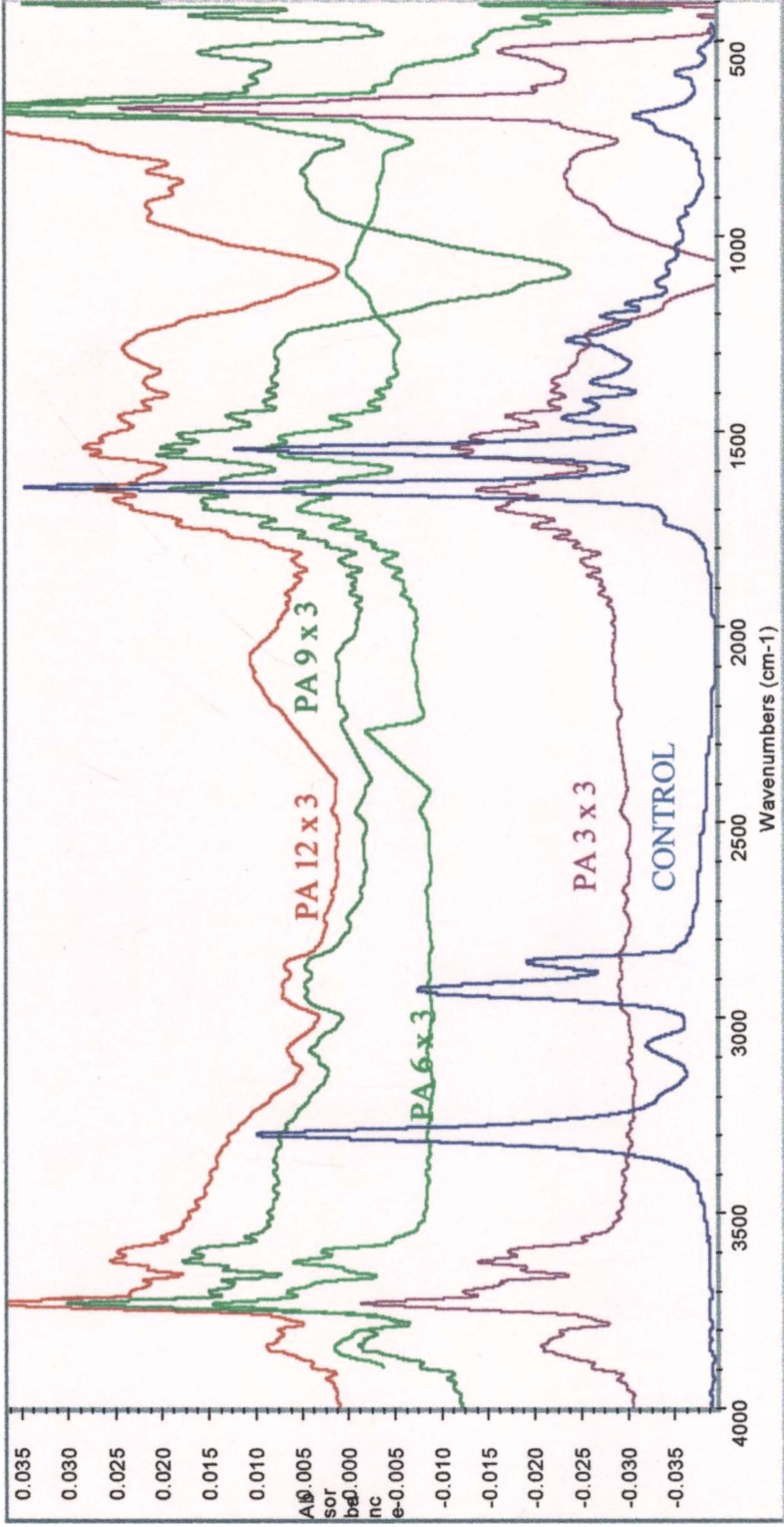


# POLY ETHYLENE 150 DAYS



**Fig. 4.14. Infrared spectra of PE samples (control and exposed to sunlight)**

# POLYAMIDE MULTI FILAMENT



**Fig. 4.15. Infrared spectra of PA multifilament (control and exposed samples)**

## POLY AMIDE MONO FILAMENT 180 DAYS

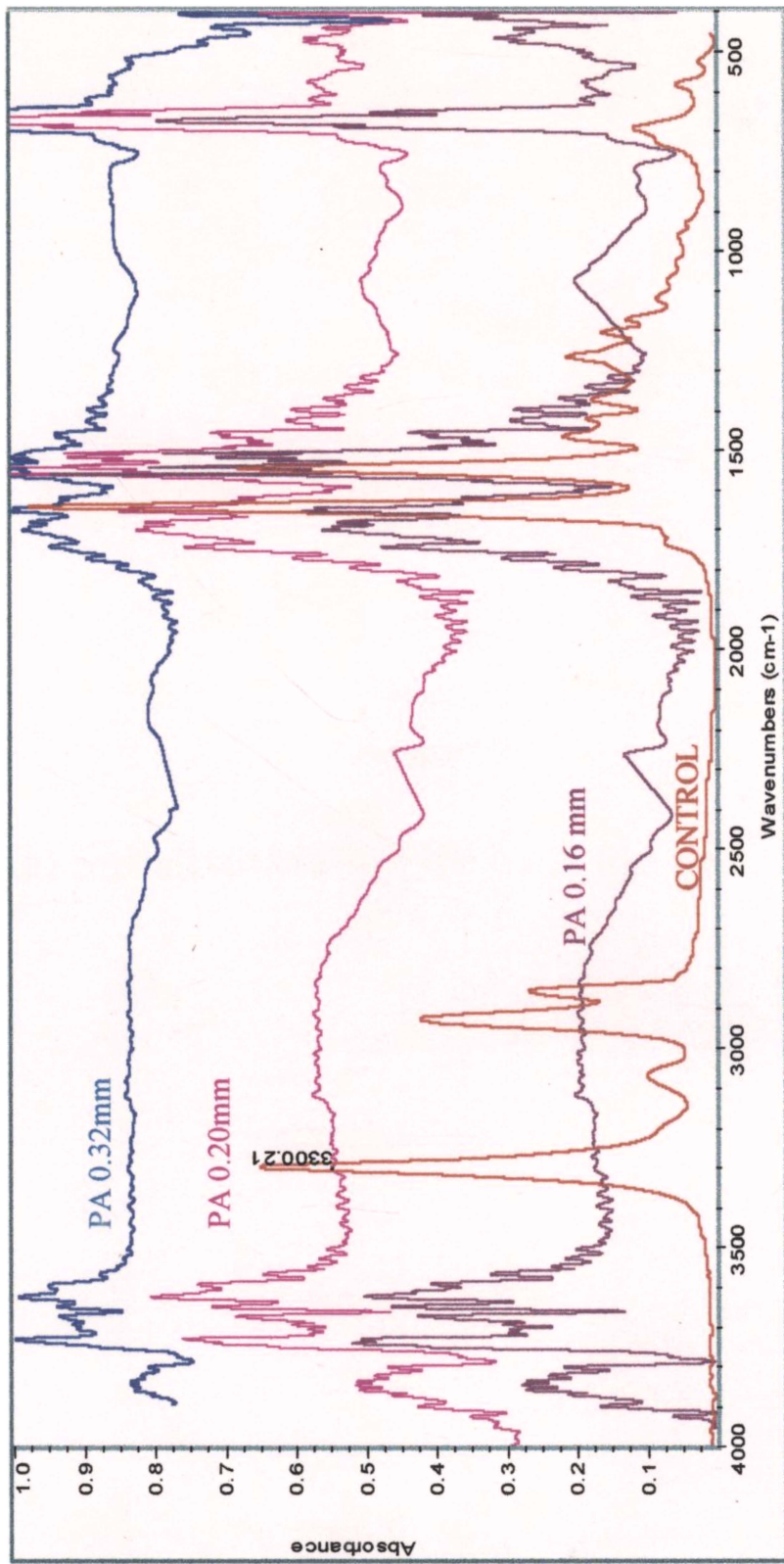


Fig. 4.16. Infrared spectra of PA monofilament (control and exposed samples)

## **Chapter 5**

# **Material Substitution in Gill Nets for Seer and Tuna**

## Chapter 5

# MATERIAL SUBSTITUTION IN GILL NETS FOR SEER AND TUNA

### 5.1. Introduction

The choice of material for a gear depends on its availability, properties and cost. The important properties to be considered while selecting the material are breaking strength, thickness, visibility, elastic properties and softness. The thinnest material with sufficient strength for the target fish is to be selected for gill nets. Since visibility is of prime importance for gill nets, the material should have the lowest possible visibility with sufficient strength to withstand forces exerted by the fish. The twine must therefore be of small diameter having just sufficient breaking strength, depending on the species of fish to be caught (Klust, 1973).

While determining the twine diameter for deep water gill nets, due emphasis should be given to strength, fishability, shape assumed in water while fishing, durability and initial cost. Steinberg (1964) while determining visibility through under water observations found that only knots of polyethylene (PE) nets were visible while nets of

PA were clearly visible. PA possesses good tenacity and cited as one of the softest of all synthetics (Klust, 1973). However, for PA, tenacity decreases in wet condition by 10 – 20 % and 50 % by knotting (Cecily and Radhalakshmi, 1985). But the initial high tenacity makes the material strongest among the available synthetics. The PE monofilament netting yarns even though have a relatively low dry breaking strength compared to PA, this drawback is partially compensated by the fact that the former is not affected by water and the loss in strength by knotting is comparatively lower.

Since the introduction of synthetics in fishing, there has not yet been any other material better than PA for fabrication of gill nets. Firth (1950) reported that the major commercial use of PA is in the fabrication of gill nets. This statement is true in the case of Indian fishing industry also (Meenakumari *et al.*, 1993). PA multifilament is the first synthetic material to become popular in India replacing hemp and cotton. The material for drift gill nets for large pelagics namely seer, tuna and shark also has been replaced by PA multifilament. In many states of India, the PA multifilament gill nets for large pelagics was replaced by PA monofilament (Pravin *et al.*, 1998) and by PE multifilament (Pillai *et al.*, 1989; Pravin *et al.*, 1998) but for in Kerala.

The PE introduced in India during early 1960s made very little impact on the gill net fishery till the end of 70s. Pillai (1989) reported that shark gillnets of Gujarat coast were made of PE twisted monofilament of 1 to 2 mm diameter having mesh size 150 – 200 mm. Eventhough trials were carried out elsewhere (Pajot, 1980 a, b; Pajot and Das, 1981; Pajot and Das, 1984) on the improvement of drift nets for large pelagics much work had not been carried out in India. Apart from the introduction of synthetic fibres (PA multifilament) in the late 1950s for trials by Radhalakshmi and Nayar (1985), Pillai *et al.*, (1989) and Pillai (1993) little effort was devoted to upgrade the drift net fishery for large pelagics. Among these only Radhalakshmi and Nayar (1985) conducted experiments in the Kerala waters and recommended PE fibrillated twine as material worth considering for gill nets for large pelagics.

In drift gill nets for seer and tuna, the cost of the gear is worked out to be 44 to 56 % (average 49 %) and 14 to 33 % (average 19 %) of the fishing unit in motorised sector and mechanised sector respectively. Though the gear has an effective service life of 4 to 5 years, often, it is lost or damaged by ships and trawlers during night resulting in periodic replacement of gear contributing substantially to the maintenance cost. In such a situation, the replacement of costly

PA by cheaper PE (PE costs only 56 % of PA) without sacrificing much on the strength and efficiency is considered necessary to be taken up. Hence a study was conducted to make the fishing unit technically efficient by substituting with cheaper PE without any compromise on the production efficiency.

## **5.2. Materials and Methods**

The wet knot strength was considered as the criterion for selecting the specification of PE for substitution of PA. The breaking strength (wet knot), diameter and elastic elongation of the two materials are given in Table 5. 1.

PE twisted monofilament of 1.25 mm diameter was selected for substitution. The control was commercial standard gear of PA multifilament of 210dx6x3. Experimental PE net was designed and fabricated having dimensions identical to the commercial gear. Usually there is no footrope for the standard gear but stones are attached at intervals. This is adjusted in PE to account for the lesser specific gravity as referred by Carter and West (1964). Design specifications of the experimental and standard gear are depicted in Fig. 5.1 and 5.2. Mesh size of 100 mm (stretched) was chosen as this mesh size is commonly used by the fishermen to catch large pelagic



in the particular fishing centre'. The experimental gear of PE 1.25 mm diameter was designated as PE and the standard gear of 210dx6x3 as PA.

'Relative catching efficiency' of the two materials was evaluated by comparing the catches obtained by the new gear with the standard gear operated simultaneously as suggested by Fridman (1986). Experimental operations were made from a commercial fishing unit based at Chettikadu, Alappuzha. Three units each of PE and PA were connected alternately end to end as part of a fleet of net. The vessel used was a plywood canoe of 9.9 m (LOA) fitted with out board motor of 9.9 horsepower. The nets set between 1730 and 1800 hours were allowed to drift for about 3 to 6 hours along with the vessel and lifted. During each operation, the depth of fishing ground, fishing time and catch composition were recorded. The fishing covered 65 operations, out of which, the data of 53 valid operations were considered for analysis. An operation was considered as valid if there was catch, at least in one of the nets. Experimental operations covered a full season from August 1999 to May 2000.

Catch from each net was sorted into species and the total length to the nearest cm (Sparre *et al.*, 1989) and weight to the nearest gram of each fish were recorded. Data recorded included (i) length

frequency of fishes caught in the nets; (ii) breaking strength of netting tested before and after fishing; (iii) wearing rate of the nets after the fishing (Zaucha, 1964); and (iv) evaluation of work rendered by the crew for operating different nets.

Samples of webbing (10 replicates from random position) from the nets before fishing and after fishing were tested to find out the loss in breaking strength. The breaking strength was measured using Universal Testing Machine of model ZWICK 1484 in accordance with IS: 5815 (Part IV): 1971. The wearing rate of netting was assessed based on the numerical scale reported by Zaucha (1964). The data collected were analysed in the following heads to assess the technical and economic efficiency of each net. 1) relative abundance of catch in each net, 2) quantity of commercially important fish caught in each net, 3) cost of the net, 4) financial return per net, based on the selling price of the fish at the landing centre and 5) durability of the nets.

The economic efficiency of the experimental gear over the standard gear was assessed by the index of the economic efficiency (Fridman, 1986).

$$Ee = Ecn/Ecs$$

Where, Ecn = Cost efficiency of the new gear;

Ecs = cost efficiency of the standard one.

$$Ee = \frac{Ecn}{Ecs} = \frac{an \times CTn \times Tn \times bs}{as \times CTs \times Ts \times bn}$$

Where 'an' and 'as', characterises the value of the catch.

CTn/CTs, the relative catchability of the system

(CT= catch obtained / unit time)

$\frac{Tn}{Ts}$  = duration of operation

$\frac{bs}{bn}$  = operation cost + cost of the net

In all cases 'n' characterises new system and 's' the standard system.

### 5.3. Results and Discussion

#### 5.3.1. Overview of Catch

Table 5.2. shows the species composition of catch in the nets. The two nets caught sixteen groups of fishes. Of these, seer contributed 66.83 %, shark 13.72 %, tuna 8.68 %, barracuda 8.85 % and miscellaneous fishes 2 % of the total catch by weight. While PE net caught 330.09 kg of fish, PA net caught 232.45 kg. The fish species caught in the gear are grouped into three grades (A, B, C) based on commercial value. Seer fishes (*Scomberomorus commersoni*

and *S.guttatus*) and pomfret (*Parastromateus niger*) are grouped into grade A as these species fetched the highest price. Barracuda (*Sphyraena Spp.*), tuna (*Euthinnus affinis*, *Auxis thazard*, and *Thunnus albacares*) and shark (*Scoliodon Spp.*) were grouped into grade B. Mackerel (*Rastrelliger kanagurta*), caranx (*Scomberoides sp.*), catfish (*Tachysurus sp.*) and other miscellaneous fishes are classified as grade C. Table 5.3 shows the weight of fish assigned to grade A, B, and C and the return by net type. Approximately 70 % of fishes caught in both the nets consisted of grade A fish.

To find out whether there was any significant difference in the yield between the nets and between different days of operation, the results were analysed using ANOVA. Total catch as well as the dominant group viz., seer were analysed numerically and by weight separately. The log transformation was made for constructing the ANOVA. Results showed no significant difference in catch between the nets. It is inferred that the performance of the experimental gear is on par with the standard gear. Between days of operation also there was no significant difference in catch.

As there was no significant difference in catch between the nets, the mean catch /trip was considered for comparison. Table 5.4 shows the month wise catch per trip of each net. The relative catch

rate of experimental and standard gear was calculated as the ratio obtained by dividing the catch per unit effort of one gear by that of other gear (Collins, 1979). Thus, comparison of the average catch /trip of the PE net was made with the standard PA net. The relative catch rate of PE net was 1.19 times more than PA net. The better performance of PE net can be due to the non-visibility of PE monofilament nets. Steinberg (1964) while determining visibility through under water observations found that only knots of PE nets were visible while PA nets were clearly visible.

### **5.3.2. Size Distribution**

Length-frequency curves in respect of seer (*S.commersoni*), which was the dominant group in the nets, are drawn and presented. The length range of seer caught in PE net was narrow (35 to 95cm) with 75-80 cm as the modal class (Fig. 5.3). In PA net, the length range was 25 to 105 cm and the modal class was 55-65 cm (Fig. 5.4). This showed that the PE net caught a narrow size class of seer while PA net caught a wide size class. This is due to the fact that the softness of PA multifilament resulted in more entangling of fishes in this net while in PE net; fishes were caught more by gilling.

### **5.3.3. Assessment of Comparative Durability of the Nets**

Comparative durability of the two materials were assessed by (i) measuring the wearing rate of netting after fishing and (ii) measuring the retention of breaking strength of material of each gear.

#### **5.3.3.1. Wearing Rate of Nets After Fishing**

Table 5.5 shows the estimation of the mechanical wear of the netting done as per numerical scale detailed by (Zaucha, 1964). The results showed that PE net had less damage compared to PA net. This may be due to entangling of more fishes in PA net than in PE net. PA net being more softer than PE net enabled better entangling of fishes. Since the catch comprised of large and fast moving fishes, their entangling and struggle to escape damaged the net more. Zaucha (1964) also reported PA nets suffering significant mechanical wear despite their high initial strength.

#### **5.3.3.2. Assessment of Loss in Breaking Strength**

Breaking strength is an important property and a loss in strength would adversely affect the fishing efficiency of a material. Hence this property was considered for comparison of the two materials. The loss in strength after actual fishing was assessed.

After 65 fishing operations, PA webbing retained 92.59 % of the breaking strength while PE webbing retained 80.76 %. This showed that PE webbing had almost equal if not better durability than PA net.

#### **5.3.4. Cost Effectiveness of the New net**

Table 5.6 presents the comparative cost of the PA and PE nets. It shows that for a unit each of (1000 x 110 meshes), the total cost was Rs. 5086/- for PA net while the cost was Rs. 2665/- only for PE net, viz. PA net was almost twice as costly as PE net. The life of a PA net is 5 years while that of a PE net is 3 years. Fridman (1986) compared the cost effectiveness of the trawl system by considering the cost of the net and value of catch. The index of the economic efficiency,  $E_e$  is the ratio of the cost efficiency of the new system to that of a standard or established system. If the economic efficiency is greater than unity the new system is most effective than the standard one, and  $E_e$  shows the relative economical efficiency under corresponding fishing conditions.

$E_e$  was worked out and was 1.05. Since  $E_e$  is 1.05 it can be considered that the new PE net is cost effective than the standard PA net.

### **5.3.5. Estimate of Manpower Requirement:**

The requirement of man power differed for the two materials. For handling PA and PE nets, the crew requirement was 2 and 3 respectively. The increase in man power requirement for PE was due to its bulkiness, higher buoyancy and also the weight of footrope. Handling and storing of PE nets during heavy rains in the open deck was also found difficult.

The better performance of PE net showed that PE twisted monofilament twine can be considered for replacement of PA multifilament twine for seer gillnets and is in agreement with Pajot (1980 a), Pajot & Das (1984) and Radhalakshmi and Nayar (1985). Many boats were operating with fewer nets than their actual capacity, which was not the most economic use of capital, labour and fuel (Pajot and Das, 1981). Besides financial constraint and theft (personal communication) the main reason was shortage of supply of nets. The estimated gap between the demand and supply of fishing nets in the Indian fishing industry in 2000 was 7201 tonnes (Anon, 1992). Hence the replacement of PA by PE which is a cheaper material is a cost-effective innovation.



**Table 5.1. Comparative properties of materials selected**

Properties	PA	PE
Diameter (mm)	1.04	1.25
Breaking strength (dry) N	211	218
Breaking strength (wet) N	157	154
Elongation (%)	30	30-35

**Table 5.2. Fishes caught during experimental fishing**

Sl. No.	Scientific name	Common name	Local name
1	<i>Scomberomorus commersoni</i>	seer	arka / neimeen
2	<i>S.guttatus</i>	seer, spotted spanish mackerel	arka / neimeen
3	<i>Euthynnus affinis</i>	little tunny	choora / kudutha
4	<i>Auxis thazard</i>	frigate tuna	choora / kudutha
5	<i>Thunnus albacares</i>	yellow fin tuna	kera / manja choora
6	<i>Scoliodon sorrokawah</i>	yellow dog shark	naramban sravu
7	<i>Carcharhinus Spp.</i>	shark	sravu
8	<i>Rastrelliger kanagurta</i>	mackerel	aila
9	<i>Parastromateus niger</i>	black pomfret	karuthavoli / machan
10	<i>Pampus argenteus</i>	silver pomfret	avoli / machan
11	<i>Caranx Spp.</i>	trevelly	vatta
12	<i>Megalaspis cordyla</i>	horse mackerel	vankada
13	<i>Strongylura Spp.</i>	full beaked gar fish	kola
14	<i>Scomberoides Spp.</i>	leatherskin	palameen
15	<i>Tachysurus Spp.</i>	marine cat fish	valiya etta
16	<i>Sphyaena Spp.</i>	barracuda	cheelavu

**Table 5.3. Catch and returns in experimental and standard nets**

Fishes	PE net		PA net	
	Wt of fish (kg)	Total revenue* Rs	Wt of fish (kg)	Total revenue (Rs)
Group A	228.20 (69.13)**	13692.00	163.1 (70.17)	9786
Group B	101.38 (30.69)	2027.60	63.35 (27.25)	1267
Group C	0.56 (0.17)	5.60	6 (2.58)	60
Total	330.14 (100)	15725.2	232.45 (100)	11113

\* Price of fish (Rs/kg): Group a: 60, Group B: 20, Group C: 10

\*\* Percentage to the total catch in each net

**Table 5.4. Monthwise catch/trip in the nets**

Month	No. of trips	Weight (kg) of fish per trip in	
		PE net	PA net
Aug '99	10	2.7	6.56
Sept '99	17	4.83	8.79
Oct '99	13	2.09	5.15
Nov '99	3	12.3	5.19
Dec '99	5	8.35	3.5
Jan 2000	3	3.57	0.87
May 2000	2	1.41	3.70

**Table 5. 5. Estimation of mechanical wear in nets**

Sl. No.	Net type	Degree of damage	Remarks
1	PE	5	After 20 voyages
		5	After 60 voyages
2	PA	5	After 7 voyages
		10	After 12 voyages
		25	After 60 voyages

**Scale**

- 5 - Single small holes in the net
- 10 - numerous holes of several mesh sizes, single tears
- 25 - multidirectional tears of more than 10 meshes spread over the net but not to the extent that replacement is necessary.
- 75 - tears and holes such that only part of the netting can be saved to patch others.

**Table 5.6. Cost of construction of experimental and standard net**

Material Specification	Dimensions	Quantity (kg or no.)	Price/unit (Rs)	Total cost (Rs)
<b>PE net</b>				
Webbing PE 1.25 mm dia	1000x110 meshes	13.75	154/kg	2199.12
Rope	PP 6 mm dia	1.8	99	178.20
Float	PVC 100x20 mm	5.5	8	44.00
Master float	Plastic can 5l capacity	0.5	9.50	4.25
Sinkers	Concrete	22.22	1.80	40.00
Labour cost		2 man days	100	200.00
Total				2665.57
<b>PA net</b>				
Webbing PA 210 d x 6x 3	1000x110 meshes	16.48	275	4510.28
Rope	PP 6 mm dia	1.8	99	178.20
Float	PVC 100x20 mm	22.1	8	176.66
Master float	Plastic can 5l capacity	2	9.50	19.00
Sinkers	Concrete	1	1.80	1.80
Dyeing of webbing				100.00
Labour cost		1 man day	100.00	100.00
Total				5085.94

GILL NET  
EXPERIMENTAL  
CHETTIKADU (ALAPPUZHA)

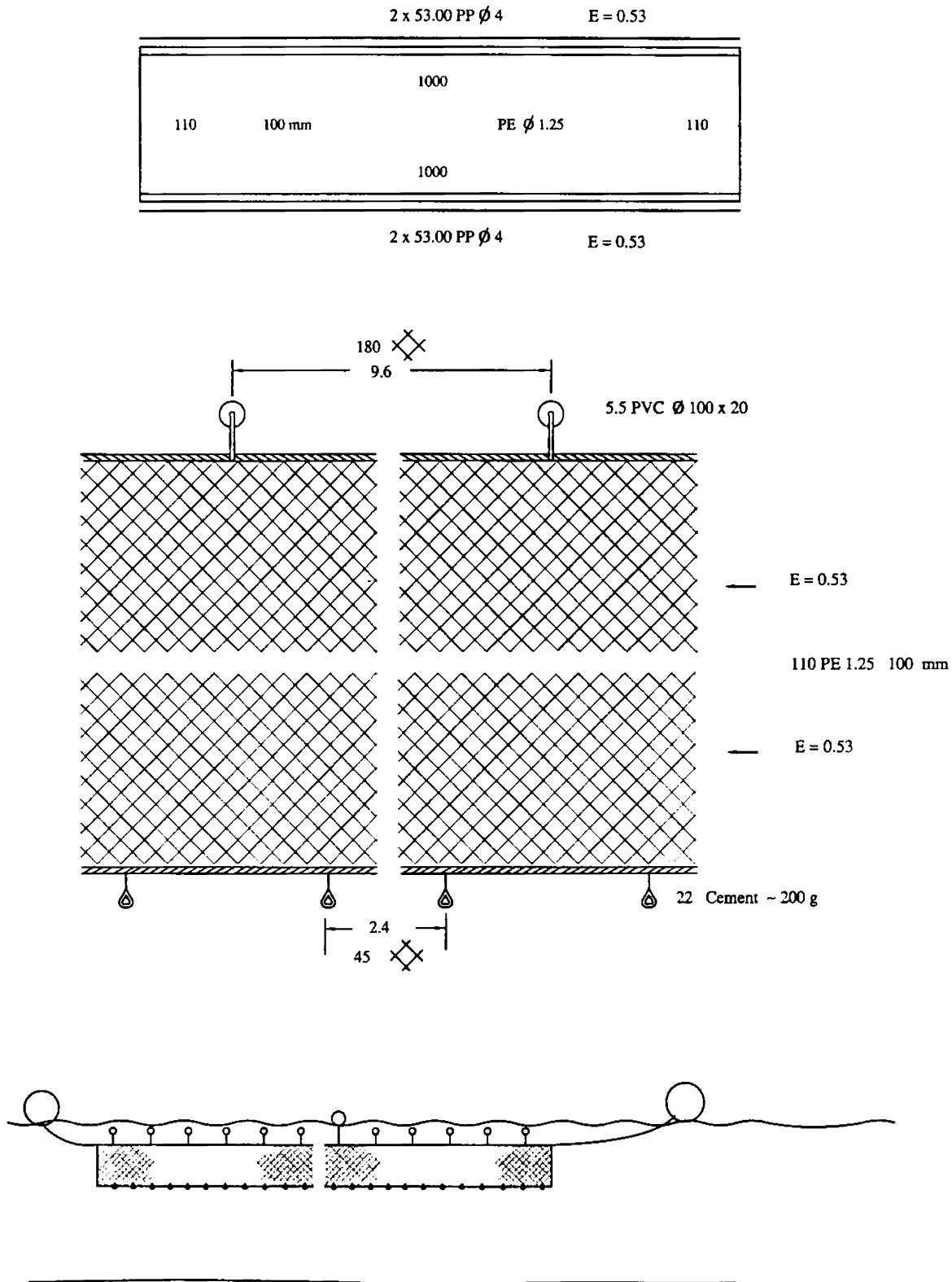


Fig 5.1. Design of gill net ( PE )

GILL NET  
 COMMERCIAL  
 CHETTIKADU (ALAPPUZHA)

2 x 53.00 PP  $\phi$  4 x 2 E = 0.53

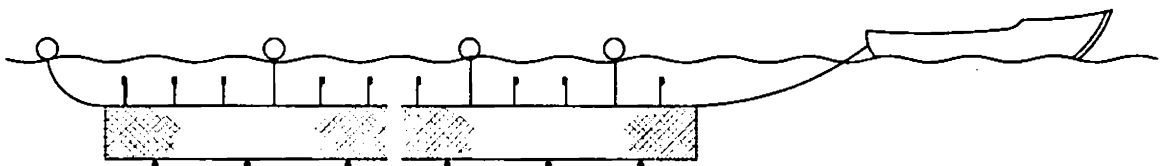
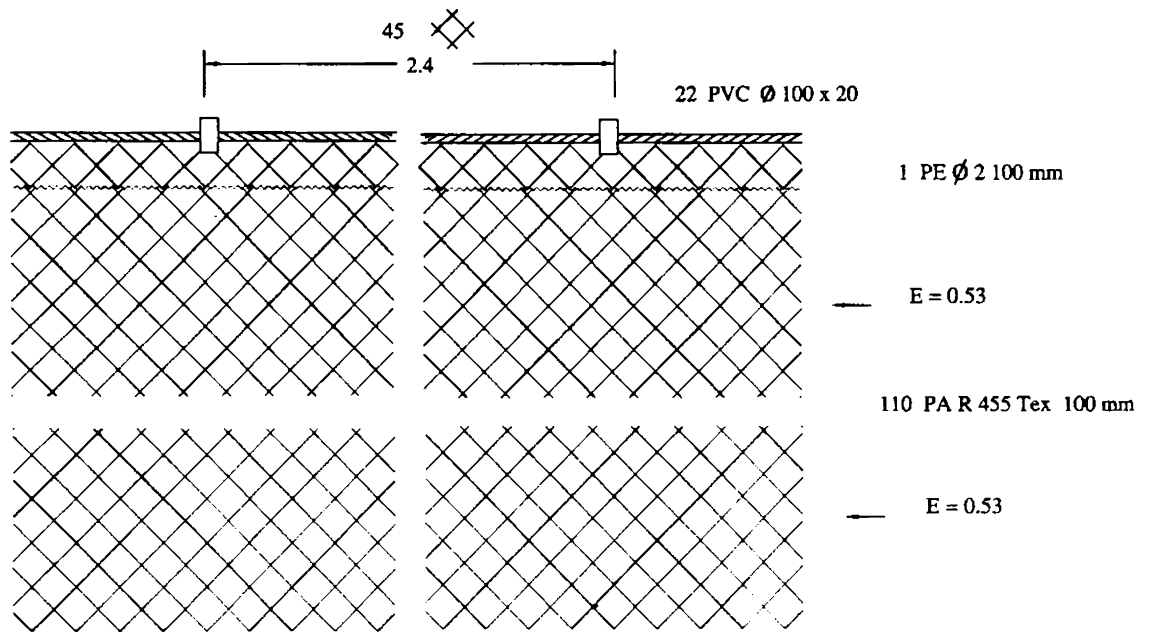
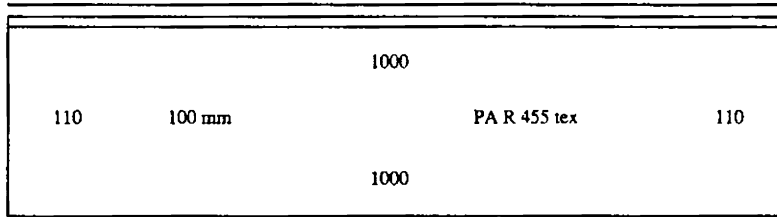
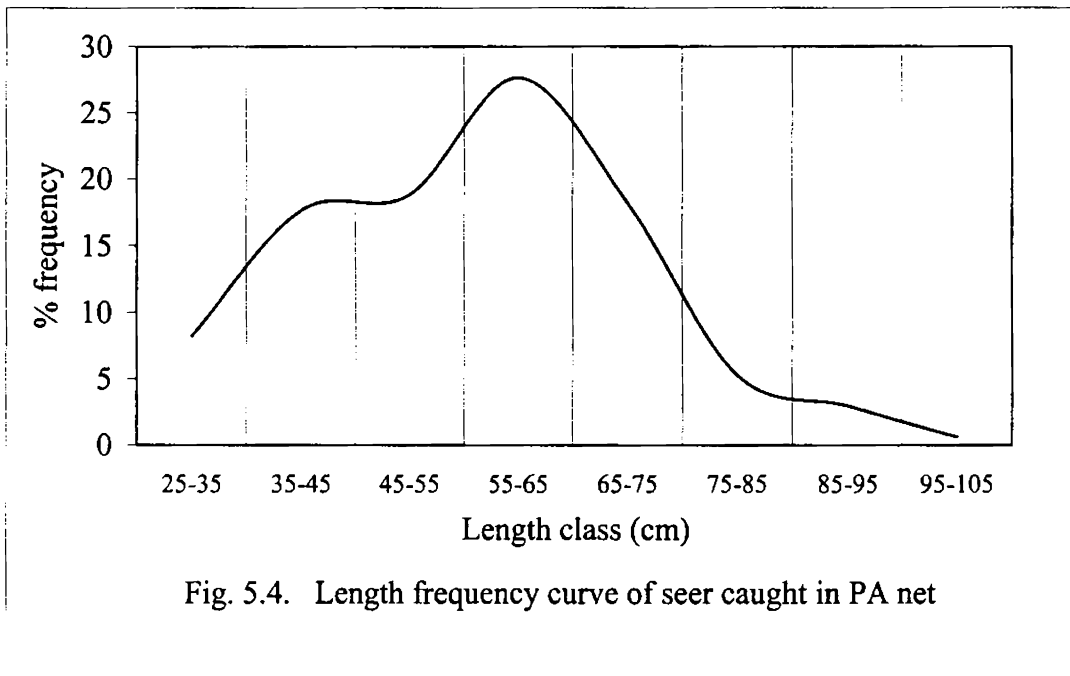
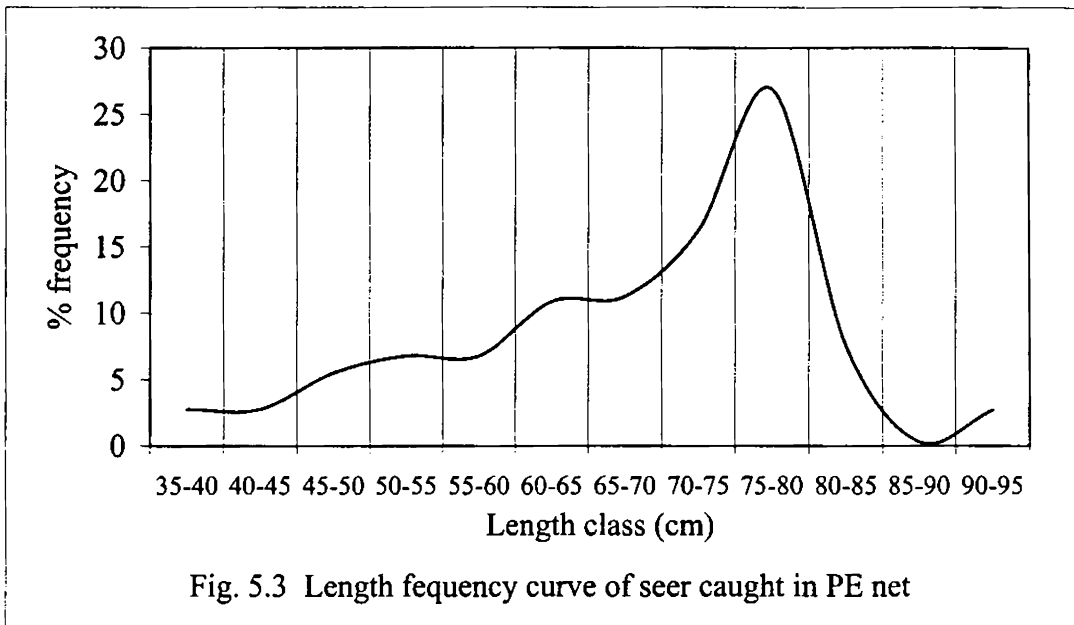


Fig 5.2. Design of gill net (PA)



**Chapter 6**  
**Selectivity**



## Chapter 6

### SELECTIVITY

This chapter deals with the selectivity in gill nets and is divided into two sections. The first section deals with selectivity of *Sardinella longiceps*, *Otolithes argenteus* and *Penaeus indicus*. The effect of small mesh gill nets on the resources is addressed in the next section.

#### SECTION 1.

##### 6.1. Selectivity Estimates for *Sardinella longiceps*, *Otolithes argenteus* and *Penaeus indicus*.

###### 6.1.1. Introduction

Selectivity is an important tool for effective management of fisheries. It is defined as the ability to target and capture fish by species, size or sex or a combination of these, allowing all incidental bycatch to be released unharmed. By regulating the minimum mesh size of a fishing fleet, the minimum size of the target species of certain fishes can be more or less determined. The importance of selecting the optimum mesh size from the standpoint of conservation of population was stressed (Havinga and Deedler, 1949; Nomura,

1961; and Burd, 1963) The selectivity of fishing gear has a direct influence on the exploited stock (Hamley and Regier, 1973; Hamley, 1975).

The selective property of gill nets was known as early as in 1882 (Collins, 1882) but its scientific study started with Baranov (1914). Later, selectivity of gillnets received much attention in various parts of the world (Baranov, 1948; Mc Combie and Fry, 1960; Regier and Robson, 1966; Mc Combie and Berst, 1969; Hamley and Regier, 1973; Hamley, 1975; Yatsu and Watanabe, 1987; Karunasinghe and Wijayaratne, 1991; Reis and Pawson, 1992 and Acosta and Appledorn, 1995). Concurrent with this, studies on optimum mesh size were carried out in India also for some commercially important species (Joseph and Sebastian, 1964; Sreekrishna *et al.*, 1972; Sulochanan *et al.*, 1975; Panikkar *et al.*, 1978; Khan *et al.*, 1989; Mathai *et al.*, 1990; George, 1991; and Mathai *et al.*, 1993).

Mesh size, visibility of net material, stretchability of meshes, net construction, method of fishing, shape of the fish and pattern of behaviour of the fish are factors determining gill net selectivity (Clark, 1960). Of these, mesh size has been the greatest influence on selection process in gill nets. Owing to the decisive role played by

mesh size in gill nets, selection occurs at both ends of the selection range as smaller fishes pass through the meshes without being caught and larger fishes will not be able to penetrate the meshes. The use of suitable mesh size in the gill net fishery is important as it creates a possibility of protecting the fish, which has not reached the minimum legal or commercial length.

Holt (1963) suggested that selection curves are bell shaped and that they can be described by the normal distribution. Gillnets are size and species selective. The size selectivity could be estimated by different ways and estimating selectivity by fitting a predetermined distribution refers to the most easily followed method devised by Holt (1963). He suggested an experiment to estimate size selectivity by using two gill nets with slightly different mesh sizes. He showed that natural logarithms of ratios of catches in numbers, for two nets with slightly different mesh sizes having overlapping selection ogives, are linearly related to fish lengths.

Mean selection length, selection factor and selection ranges are to be estimated using statistical techniques. Since, these factors vary according to the material used for webbing; such experiments are to be conducted periodically to update the information. Biological data in growth and maturity of the fish stocks are

necessary to fix the required mesh size for each species. The size of fish at which maximum growth rate is registered and the size at first maturity are two factors to be considered for fixing suitable mesh size in order to maintain the fishery in a steady state. If the mean selection length is just above these two lengths, then both recruitment and maximum growth potential of fish are taken care of, and fishing does not affect the stocks in any way. The optimum mesh size is fixed according to the species, taking into consideration the size at recruitment, the optimum age of exploitation and the size at first maturity (Kalawar *et al.*, 1985). *Sardinella longiceps* is a common species in the inshore waters of Kerala. The selectivity estimate of this important species has not been done so far but for a preliminary study by Joseph and Sebastian (1964).

Sciaenids comprising different species constituted around 20 % of the catch of gillnets. Mesh size ranging from 30 to 52 mm caught different species and size of this important group. No work has been carried out on the selectivity aspects of this group of fishes.

Studies conducted on the prawn gill nets are mostly related to comparative efficiency with respect to material difference and design aspects (Mathai *et al.*, 1990; Thomas *et al.*, 1993). George (1991) carried out studies on the length frequency distribution of *P. indicus*.

The main objectives of this study are to determine (i) the optimum selection length, selection factor and probabilities of capture for *S.longiceps*, *O.argenteus* and *P.indicus* caught in PA monofilament gill nets of mesh size ranging from 30 to 50 mm; and to arrive at the minimum size of mesh to be used to prevent capture of fishes below the size at first maturity.

### **6.1.2. Materials and Methods:**

The catch of gill nets was sampled for a period of 12 months at the fish-landing centre at Beach road, Kannamaly. PA monofilament nets with 0.16 mm diameter having a fishing height of 2.4 to 4.6 m and mesh sizes 30, 32, 34, 36, 38, 40 and 50 mm rigged with a hanging coefficient 0.53 were selected. The total length of individual fish was measured to the nearest mm (Sparre *et al.*, (1989). Total lengths of 150 to 200 fishes obtained by random sampling were measured monthly. The mesh sizes were determined by measuring the stretched meshes with a centimeter scale (FAO, 1978). Measurements were taken from 5 randomly chosen regions of the net and the average values worked out. The data, from the mesh size 30 mm was not analysed, as the data was insufficient. The selectivity was estimated by using the indirect method of Holt (1963).

According to him for gilling and wedging the selection curves are bell shaped and can be described by the normal distribution. Thus

$$S(L) = \exp \left[ -\frac{(L - L_m)^2}{2s^2} \right]$$

Where  $S(L)$  is the length based gear selectivity,  $L$  is length interval midpoint,  $L_m$  is the optimum length for being caught and  $s$  is the standard deviation of the normal distribution.

The procedure involves:

Calculation of the proportion between the number of fish of a particular length retained in gill nets of different mesh sizes:

(2)  $\frac{C_b}{C_a} = \frac{\text{no. of fish of length } l \text{ in a net with larger mesh size (m}_2\text{)}}{\text{no. of fish of same length } l \text{ in a net with smaller mesh size (m}_1\text{)}}$

(3) Calculation of log ratios for successive fish lengths

$$Y = \ln(C_b/C_a)$$

(4) Regression analysis of the log ratios against the interval midpoint and expressed as

$$Y = \ln(C_b/C_a) = a + bL$$

Where  $Y$  is the natural logarithm of ratio of catches,  $L$  is the midpoint of the length class, and  $a$  and  $b$  are constants.

(5) The selection factor (SF) was calculated according to Jones (1984)

$$SF = (-2a) / [b (m_1 + m_2)]$$

where  $m_1$  and  $m_2$  are the mesh size of two gill nets with slightly different mesh size

(6) The optimum selection lengths ( $L_1$  and  $L_2$ ) in the two gillnets were calculated from the following equations:

$$L_1 = SF \times m_1$$

$$L_2 = SF \times m_2$$

(7) The standard deviation ( $S$ ) of each probability function was calculated (Jones, 1984) as follows:

$$S = (L_2 - L_1)^{0.5} / b$$

(8) Using the values for  $L_1$ ,  $L_2$  and  $S$ , the probability ( $P_1$ ) of capture for a given length  $L$  in a gill net having a mesh size  $m_1$  was calculated (Pauly, 1984).

$$P_1 = \exp [-(L - L_1)^2 / (2S^2)]$$

Similarly the probability of capture ( $P_2$ ) for the mesh size  $m_2$  was calculated as

$$P_2 = \exp [-(L - L_1)^2 / (2S^2)]$$

Selectivity curves were drawn using probability of capture against each length class. The optimum selection length calculated for each mesh size was compared with the size at first maturity.

### **6.1.3. Results and Discussion**

#### **6.1.3.1. *Sardinella longiceps***

Percentage length frequency distribution of *S.longiceps* caught in gillnets of mesh size 32, 34, 36, 38 and 40 mm is given in Table 6.1. The total length of *S.longiceps* caught ranged from 12 to 20 cm. The modal lengths caught in the smallest mesh size 32 mm was 15.5 cm and this increased with increasing mesh size to 15.5, 16.5, 17.5 and 18.5 cm in 34, 36, 38 and 40 mm mesh size respectively. Joseph and Sebastian (1964) recorded 12.1 to 20 cm as the size range of *S.longiceps* caught in gill nets of mesh size 28 to 41.8 mm. The modal lengths recorded in the present study were smaller than those reported by Joseph and Sebastian (1964).

The data used for the calculation of selectivity parameters are presented in Table 6.2. The distribution of the points designated by  $\ln(C_b/C_a)$  for the successive pairs of gill nets is presented in Fig.6.1. The high regression coefficients for the relationships between catch ratios of mesh size combination and length class midpoint for all the



pairs of nets indicated that these two parameters were closely inter related. The slopes and intercepts of the plots of natural logarithms of catch ratios for slightly different mesh size combinations against midpoints of class intervals, together with estimated values for standard deviation of catch ratios are given in Table 6.3. A relatively large positive slope characterises the analysed distributions.

Using the values from Table 6.3, the selection factors and optimum selection lengths were estimated. The values for the optimum length, standard deviation and selection factors were taken as the average of the two combinations, which share the same mesh size except for the two extreme mesh size, 32 and 40 mm as suggested by Pauly (1984). The results of the analysis are given in Table 6.4. The optimum selection length gradually increased with increasing mesh size from 14.7 cm in 32 mm mesh size to 18.7 cm in 40 mm mesh size. The selection factor ranged from 4.56 to 4.67. Mesh size of 32 mm had a high selection factor and it decreased in 34 mm mesh size. However, for mesh sizes 36 to 40 mm, the selection factor increased gradually with increase in mesh size. This can be due to the change in body proportion due to the sexual maturity (Strzyzewski, 1964; Dayaratne, 1988). In the present study the size distribution with respect to sex was not worked out.

Probability of capture of *S.longiceps* of each length class for different mesh size was determined using values of Table 6.3 and 6.4. In Fig. 6.2, the estimated selectivity curves are presented and compared with the observed length frequency distributions of fish captured in nets of different mesh sizes.

In 32 mm mesh size, the length of fish showing the maximum probability of capture was 14.5 cm. This value gradually increased with increasing mesh size up to 18.5 in 40 mm. The heights of the selectivity curves for different mesh sizes were uniform (Fig. 6.2). The curves of selectivity showed how mesh size affected the exploited population of *S.longiceps*. The greatest likelihood of being retained in a net of mesh size 32 mm was exhibited by *S.longiceps* in the length class of 14 to 15 cm total length (Table 6.4, Fig. 6.2). For the nets of the biggest mesh size 40 mm these were the fishes in the length class of 18 to 19 cm total length. The mode of the observed length frequencies and calculated optimum selectivity length showed deviation only in mesh size of 32 mm where the mode of observed length frequency was 5.16 % higher than the estimated mean selection length.

The estimated selectivity indicates that the fish that are retained, attained the 'optimal' length for a particular mesh size

irrespective of the minimum legal length. The size at first maturity was taken as the minimum legal length since no legal length for the capture of *S.longiceps* is currently in force in Kerala. It is important to compare the estimated mean selectivity length with the size at first maturity of fish. Somvanshi (1980) opined that the knowledge of minimum size at first maturity was of value in adjusting the mesh size of fishing gear to ensure that the smaller fish, which have not spawned even once, may have an opportunity to escape. The records of the size at first maturity of *S.longiceps* are varying from 14 to 17 cm (Hornell and Naydu, 1924; Nair, 1953; Antony Raja, 1964; Annigiri, 1972 and Dhulkhed, 1976). However Qasim (1973) made a consensus as fish attained sexual maturity at about the end of first year approximately between 15 to 16 cm. Accordingly the mid value of this class was considered here as the size at first maturity. According to the estimated selection, nets of a mesh size of 32 mm retained 39.8 % of fish whose total length was less than 15.5 cm. Nets of mesh size 34, 36, and 38 mm retained 11.6, 3.6 and 0.4 % respectively of individuals below the length at first maturity (Fig 6.3). Mesh size of 40 mm retained mature specimens only. Considering this, the use of gillnets of mesh size 32 and 34 mm did not ensure effective protection to juvenile *S.longiceps*. Since the estimated

optimum selection length of *S.longiceps* was above the size at first maturity in all cases except 32 mm, mesh sizes above 32 mm can be used safely to exploit the resource. However, 32 mm may not be used for exploitation of *S.longiceps* as it would not give effective protection to the resource.

#### **6.1.3.2. *Otolithes argenteus***

*Otolithes argenteus* occurring in the small mesh catch almost throughout the year was selected for selectivity estimation. The catch of *O.argenteus* caught in mesh size 34, 38, 40 and 50 mm were considered for analysis.

Length frequency distribution of *O.argenteus* caught in these mesh sizes was given in Table 6.5. The size ranged between 10 to 20, 13 to 22, 14 to 22 and 16 to 25 cm in mesh size 34, 38, 40 and 50 mm respectively. The modal length of *O.argenteus* ranged from the lowest of 14.5 cm in 34 mm mesh size to the highest of 22.5 cm in 50 mm mesh size. The data used for the calculation of selectivity parameters are presented in Table 6.6. The distribution of the points designated by  $\ln (C_b/C_a)$  for the successive pairs of gill nets is given in Fig.6.4. Mesh size combinations except 38 and 40 mm exhibited high regression coefficients for the relationship between catch ratio of

mesh size combination and length class mid points. Mesh size combination 38 and 40 mm also fulfilled the condition for plotting linear regression as the  $r^2 > 0.5$ .

The slopes and intercepts of the plots of natural logarithms of catch ratios for slightly different mesh size combinations against midpoints of class intervals, together with estimated values for standard deviation of catch ratios are given in Table 6.7. The estimated selection factors and optimum selection lengths, computed using the values from table 6.7 are given in Table 6.8. The optimum selection lengths increased gradually with increasing mesh size from 15.2 cm in the smallest mesh size (34 mm) to 18.3 cm in 40 mm mesh size and to 22.8 cm in 50 mm mesh size.

The increase in selection factors was gradual from 4.48 in 34 mm mesh size to 4.57 in 40 mm mesh size, but decreased to 4.55 in 50 mm mesh size. Selection factors have been shown to be related to body proportions (Strzyzewski, 1964 and Dayaratne, 1988). Karunasinghe and Wijeyaratne (1991) also observed an increase in selection factor with increasing mesh sizes.

The probability of capture of *O. argenteus* of each length class for different mesh size was computed using values of Table 6.7 and

6.8. The estimated probability of capture as against observed length frequency distribution is depicted in Figure 6.5. The length of fish showing the maximum probability of capture in 34 mm mesh size was 15.5 cm. This value gradually increased with increasing mesh size upto 22.5 cm in 50 mm mesh size. The height of the selection curves was uniform. (Figure 6.5). The mode of the observed length frequency distribution and estimated selection curve coincides only in 40 and 50 mm mesh sizes only while it was 4.6 % lower than the estimated selection curve in 34 mm mesh size and was 7.0 % higher in 38 mm mesh size. This can be due to the shape of the body of *O. argenteus*, which does not have smooth body, and possess protruding dorsal spines and spiny appendages. This explained the deviation of the mode of the observed length frequency from the estimated mean selection lengths in the smaller mesh sizes 34 mm and 38 mm.

The estimated selectivity was compared with the length at first maturity to ensure that the mesh size used should be of the size, which releases the specimens which have not spawned at least once. For *O. argenteus*, the size at first maturity is 15.1 cm (Basu, 1975). When comparing against this, net of mesh size 34 mm retained 59.6 % of fish whose total length is less than or equal to 15.1 cm (Fig.

6.6). Nets of mesh size 38 mm and above retained only mature specimens i.e. of length > 15.1 cm (Fig. 6.6). The estimated optimum selection length of *O. argenteus* was above the size at first maturity in the case of 34 mm also. Hence, mesh of 34 mm can also be considered for the exploitation of *O. argenteus*. However, since comparison with the observed length frequency showed more than 50 % of the fishes caught as juveniles, 34 mm mesh has to be used with caution.

#### **6.1.3.3. *Penaeus indicus***

Prawn gill nets of the inshore areas of Kerala have different mesh size ranging from 33 to 52 mm. Out of these, four mesh sizes viz., 34, 38, 40 and 50 mm were selected for the selectivity analysis. Length frequency distribution of *P. indicus* caught in gill nets of the above mesh size are given in Table 6.9. The selection range for different mesh sizes was from 8.0 to 19.0 cm total length. The modal length classes were 11 - 12 cm, 12 - 13 cm, 12-13 cm and 15 - 16 cm in mesh sizes 34, 38, 40 and 50 mm respectively. This showed a gradual increase of modal size with increase in mesh size. The modal length classes recorded by George (1991) were 10-11, 11-12 and 14-15 cm in mesh sizes 34, 38 and 50 mm.

The data used for the calculation of selectivity parameters are presented in Table 6.10. The distribution of the points designated by  $\ln(C_b/C_a)$  for the successive pairs of gill nets is presented in Fig.6.7. All the mesh size combinations had high regression coefficient fulfilling the basis for plotting linear regression. The slopes and intercepts of the plots of natural logarithms of catch ratios for slightly different mesh size combinations against midpoints of class intervals, together with estimated values for standard deviation of catch ratios are given in Table 6.11. The estimated selection factor and optimum selection lengths are given in Table 6.12. The optimum selection lengths increased gradually with increasing mesh sizes from 10.7 cm in 34 mm mesh size to 16.6 cm in 50 mm mesh size. Selection factor increased gradually from 3.15 to 3.32 with an increase in mesh size.

The probabilities of capture of *P.indicus* of each length class for different mesh sizes were calculated using value from Table 6.11 and 6.12. The estimated selectivity curve against the observed length frequency distribution is given in Fig. 6.8. The length of *P.indicus* showing the maximum probability of capture in 34 mm mesh size was 10.5 cm. This value gradually increased with increasing mesh size to 16.5 cm in 50 mm mesh size. The heights of the selectivity curves were uniform. (Fig. 6.8). The mode of the observed length



frequency deviated from the estimated mean selection length by 5.3 % and 6.6 % lesser for the mesh size 40 and 50 mm respectively and by 7.5 % higher for the mesh size 34 mm. The modal length class of observed length frequency and estimated optimum selection length coincided only in 38 mm. This may probably be due to the suitability of the particular mesh size to the size class of *P. indicus* exposed to the nets. George (1991) also reported the suitability of 38 mm mesh size for catching *P.indicus* of commercial size. In the other meshes, the deviation may be due to varied size groups exposed or due to entanglement of large individuals of *P. indicus* by their many spined appendages.

Comparison of the estimated optimum selection lengths of *P. indicus* for each mesh size was made against the size at first maturity to assess the suitability of the mesh size in exploiting *P. indicus* in a responsible way without affecting the stocks. The size at first maturity of *P. indicus* is 130.2 mm (Rao, 1968). According to the estimated selection of gill nets for *P. indicus*, nets of mesh size 34 mm and 38 mm retained 89 % and 77 % of *P. indicus* whose total length is less than 130.2 mm (Fig. 6.9) whereas 40 mm and 50 mm mesh size retained 56.1 % and 39.7 % respectively which showed that the latter were better in catching larger size groups. Use of 34

and 38 mm mesh sizes did not assure effective protection of juveniles of *P. indicus*. However, fixing of mesh size 40 mm is on the higher side as from the economic view point, the quantum of catch will be less, affecting returns.

The selectivity estimates for these three species showed that the mesh sizes currently in use could not protect the resources. However, in a multispecies fishery the mesh size could be fixed on the above criteria for the most commercially important group only. In the small mesh gill net sector, where different mesh sizes are used simultaneously to exploit a multitude of species, identifying the dominant group itself need detailed investigations. An analysis of the small mesh gill net sector with special emphasis on catch composition and size composition has been done and the results are detailed in section 2.

## *SECTION 2*

### **6.2. CATCH ANALYSIS IN SMALL MESH GILL NETS**

#### **6.2.1. Introduction**

The fishing fleet in a tropical inshore gill net fishing system may consist of more than one category (mesh size) of gill nets. This results in the occurrence of different size groups of a species in the catch from a landing centre. Thus, in spite of the known selectivity of the gill net for a particular narrow size range of fishes, the use of different mesh sizes results in a wide size range. In tropical inshore waters a gill net fleet will have different pieces having different mesh size. Since the non-motorised sector operate exclusively in the inshore waters and use a wide variety of mesh size simultaneously unlike their counterparts in the mechanised and non-motorised sectors, a study of their catch will throw light on the state of the inshore fishery. Luther and Appanna (1993) reviewed the size composition of the fishery resources in the various localities of India and indicated that the bulk of the landings comprised of juveniles. They suggested that documentation of basic data such as length frequency, percentage occurrence of adults and juveniles facilitate

critical evaluation of the status of a particular fishery. Hence, with the following objectives, a study was taken up. The main objectives were to examine:

- i) seasonality of usage of different mesh sizes
- ii) catch composition of the small mesh gill nets; and
- iii) proportion of immature specimens of important species caught in each mesh size.

### **6.2.2. Materials and Methods**

The site of investigation was Beach road landing centre at Kannamaly; a major landing centre of the non-motorised country crafts employing gill nets. The centre was visited in the mornings, once a week, for a period of two years, from March 1998 to February 2000. Measurements of fish and mesh size were as detailed in section 6.1.2. The collection of data from selected units on species composition and total catch were made following Alagaraja, (1984). Samples taken from well-mixed catch were sorted out to generic and species level. These specimens were identified and weighed to the nearest gram. The identification of the species was made as per Fischer and Bianchi (1984). The craft in use were plank built canoes of LOA 5.7 to 6.7 m and operations were carried out during early

mornings at depths of 3 to 12 m. The data analysis included calculation of length frequency of major group of fishes and comparison of the length frequency against the size at first maturity. Specimens with 'total length' below the size at first maturity were considered as juveniles. Fishes, which grow to a maximum of 30 cm (total length), were grouped under 'small bodied fishes' and those, which grow above this size, were grouped under 'large bodied fishes'.

### **6.2.3. Results and Discussion**

The observations were discussed with respect to seasonal variation in the use of different mesh size, catch characteristics and size composition with occurrence of juveniles.

#### **6.2.3. 1. Seasonal Variation in the Use of Mesh Sizes**

The mesh sizes in use were 30, 32, 34, 36, 38, 40, 48, 50, and 52 mm. The fishermen used different mesh size, in different months depending on the availability of fishes. The seasonal use of different mesh sizes is represented in Fig. 6.10. Mesh sizes of 34, 36 and 38 mm were used almost throughout the year and 30 mm was used in March, April, October and December. 32 mm was used from March to May and September to January. Mesh sizes of 48, 50 and 52 mm

targeted for mackerel were used during October to February. Hornell (1938) reported only two main types of gill nets in operation viz., aila chala vala and mathi chala vala for mackerel and sardine respectively during 1930s. Vijayan *et al.*, (1993) recorded only six types of gill nets in operation in 1958 and eleven types in 1991. The availability of machine made synthetic webbing in varying mesh sizes may be one of the reasons for the present use of specific mesh size for specific resource. Another probable reason can be that fishermen were forced to adopt efficient tackles for catching all size groups in view of the scarcity of resources.

### **6.2.3. 2. Catch Characteristics**

A total of 38 genera/species of fishes constituted the catch (Table 6.13). The complexity of the multi-species nature of the tropical inshore waters is clearly understood from the varying species caught. The percentage composition of important groups is represented in Fig. 6.11. Of these, 9 groups: sciaenid, oil sardine, mackerel, mullet, lesser sardines, flat fish, *Thrissocles* sp., *Penaeidae* and *Leiognathidae* together contributed 95 % (by weight) of the total catch in all the mesh sizes. The remaining 5 % grouped under 'others' comprised of *Eleutheronema tetradactylum*, *Sillago sihama*, *Scomberomorus commersoni*, *Megalaspis cordyla*, *Lactarius*

*lactarius*, *Stolephorus Spp.*, *Caranx Spp.*, *Pampus argenteus*, *Parastromateus niger*, *Anadontostoma chacunda*, *Therapon jarbua*, *Ambassis sp.*, *Pellona Sp.*, *Scoliodon Spp.*, and *Neptunus Spp.*

Year to year variation in catch was assessed for the years 1998-99 and 1999-00 and is represented in Fig. 6.12. Sciaenids, mullets and soles were dominant in 1998-99 while mackerel, prawn, lesser sardine and shark dominated in 1999-00. Sardine was dominant in both the years. The average month-wise representation of the groups of fishes for the two-year period is depicted in Fig. 6.13. Sciaenids dominated the catch in June, July and August; oil sardine in the months of April, May and June and mackerel formed the dominant group during November and January to March. The month-wise representation of the composition of the catch in two successive years is given in Fig. 6.14. It showed that the dominance of groups had wide variation in different months and even for the same month in successive years.

### **6.2.3. 3. Proportion of Juveniles**

The groups of fishes, which were caught in appreciable quantity, were subjected to length frequency estimation. The mean length and length frequency are represented in Fig. 6. 15 and 6.16.

Remarkable difference was evident from the length range and mean length of major groups/species of fishes caught in the different meshed gill nets. While fishes less than 20 cm were well represented in mesh sizes of 30, 32, 34, 36, 38 and 40 mm, they were completely absent in mesh size of 48 mm and above. It is also quite evident from Fig.6.15 and 6.16 that almost all the fishes above 20 cm caught in the nets belong to small bodied fishes, except seer (*Scomberomorus commersoni* and polynemus (*Eleutheronema tetradactylum*) rather than being the young of large bodied fishes.

Size composition and proportion of juveniles were worked out with respect to the following dominant groups. The proportion of juveniles caught in each mesh size is given (Table 6.14).

### **Sciaenids**

Sciaenids known either as jew fishes or croakers are widely distributed in India. In the present investigation, *Johnius* sp. *Johneops* Spp. and *Otolithes* Spp. were encountered in the catch. Nets of 30 mm mesh size caught entirely of juveniles. Those caught in 32 and 34 mm had 72 and 24 % juveniles respectively.



### **Oil sardine (*Sardinella longiceps*)**

Oil sardine caught in mesh size 30, 32, and 34 mm consisted of 32, 16, and 10 % juveniles respectively. Mesh size above 34 mm consisted mostly of adult sardines. Joseph and Sebastian (1964) worked out 33.4 mm mesh as the optimum, compared to 28, 38.6 and 41.8 mm mesh size for the exploitation of *S.longiceps* in Kerala waters. The majority of sardine catch was during the months of April, May and June. Of these three months, the use of 30 mm was mostly restricted to April only. The mesh 34 mm was in use in all the months. 32 mm mesh was used in April and May but it formed less than 25 % of the total volume of nets taken for fishing.

### **Mackerel (*Rastrelliger kanagurta*)**

Mackerel caught in 48, 50 and 52 mm consisted of adult specimens only. However, those caught in mesh sizes 30, 32 and 34 mm consisted exclusively of juveniles. Mesh size of 36 and 38 mm had 97 and 84 % of juveniles. The catch in these five mesh sizes contributed 43 % of the total mackerel catch and was restricted to March, April, May and September. From October to February, 48 mm and above were operated. Mackerel caught in nets of 30 to 38

mm mesh sizes were non-target catch. However the use of 30-40 mm mesh size during March to May and September cannot be prevented, as during this period, most of the other fishes especially sardines were caught in plenty. Mackerel fishery is mostly supported by juveniles (Bal and Rao, 1984). Noble (1982) reported that large size groups supported the fishery during pre monsoon period and juveniles were the mainstay of the monsoon fishery. The use of larger mesh size 48, 50 and 52 mm during October to February and 30 to 38 mm during March, April, May and September in the present investigation is in agreement with this.

### **Lesser sardines**

Among lesser sardines, white sardine (*Kovala coval*), *S.gibbosa* and *Dussumeria hasselti* were encountered in the catch. *K.coval* contributed 4.6 % of the total catch and was caught mainly during the months of September - December in 32 mm and 30 mm mesh. While considering the length at maturity as 8-9 cm (Chidambaram and Venketaraman, 1946) the entire catch of *K.coval* consisted of adult fishes.

## **Flat fishes**

Flat fishes or soles, which contributed 4.5 % of the total catch, comprised mainly of *Cyanoglossus macrostomus* and were caught mostly in 32 and 34 mm mesh size. It was observed that 56 % of the catch in 32 mm comprised of juveniles. Its operation was restricted to September, October and November months. After the cessation of monsoon these formed shoals in the inshore areas and remained there till October. They migrated into the inshore waters during September – October along the West Coast.

## **Silver bellies**

Silver bellies constituted 2 % of the total catch. *Leiognathus bindus* and *Secutor insidiator* were the dominant species caught. 40, 23, and 5 % of them caught in 32, 34 and 38 mm respectively were juveniles. Those caught in mesh above 38 mm were mature specimens.

Seer and Polynemus caught in all mesh size were juveniles.

Examination of the results indicated that small mesh gill net fishery in the inshore waters of Cochin area project a typical case of the multispecies nature of the tropical fishery. The results showed

that the fishes caught in mesh sizes except 30 and 32 mm, were mostly adults. However, seer and polynemus caught in all mesh sizes and mackerel caught in less than 48 mm, were juveniles.

Gill netting, eventhough is a selective fishing method, in a multi-species fishery, use of small mesh sizes may result in the capture of juveniles. Luther *et al.*, (1994) reported the landing of juveniles of lesser sardines by gill nets less than 28 mm mesh size and stressed the need to regulate gill net fishing. Figs.6.12 and 6.13 shows the presence of fishes of varying sizes in different months and this makes it difficult to have any regulation on the fishery in the inshore waters. Suggesting methods of managing the multispecies and multimesh fishery of Kerala is difficult. As the successful spawning period of most of the fishes is during May to July, the fishing during this period has to be regulated to protect the spawning stock and after July, gill nets of mesh sizes above 40 mm, be encouraged to catch post-spawners (Yohannan *et al.*, 1999). The present study suggests that gill netting can be encouraged as a selective fishing method with the restraint use of 30 and 32-mm mesh sizes. The use of mesh sizes in succession as per the availability of the resource may render gill netting a more ecofriendly fishing method for the inshore waters.

**Table 6.1. Percentage length frequency of *S. longiceps* caught in different mesh size**

Length class (cm)	Mesh size (mm)				
	32	34	36	38	40
	Percentage frequency				
12-13	1.85	0.00	0.00	0.00	0.00
13-14	9.26	0.53	0.61	0.00	0.00
14-15	28.70	11.11	2.76	0.41	0.00
15-16	48.15	55.03	22.09	3.72	0.71
16-17	11.11	28.04	41.41	16.53	5.67
17-18	0.93	4.76	30.37	33.06	27.66
18-19	0.00	0.53	2.76	30.99	36.17
19-20	0.00	0.00	0.00	14.05	28.37
20-21	0.00	0.00	0.00	1.24	1.42

**Table 6.2. Number of *S.longiceps* in length classes caught in different mesh size**

Mesh size (mm)	Centre of length class (mm)									Total no. of fish
	12.5	13.5	14.5	15.5	16.5	17.5	18.5	19.5	20.5	
32	4	20	62	104	24	2	0	0	0	216
34	0	2	42	208	106	18	2	0	0	378
36	0	2	9	72	135	99	9	0	0	326
38	0	0	2	18	80	160	150	68	8	486
40	0	0	0	2	16	78	102	80	4	282
Total	4	24	115	404	361	357	263	148	12	1688

**Table 6.3. Results of the regression analysis between natural logarithms of relative catch ratio against class midpoint for *S.longiceps***

Mesh size combination (mm)	Intercept (cm)	Slope	Regression coefficient	Estimated Standard Deviation (cm)
32 – 34	-16.515	1.087	0.9536	0.882
34 – 36	-22.512	1.401	0.8697	0.68
36 – 38	-22.774	1.36	0.9380	0.6975
38 – 40	-14.7225	0.864	0.9823	1.1574

**Table 6.4. Selectivity estimates of *S.longiceps* for different mesh size**

Mesh size (mm)	Optimum selection length (cm)	Selection factor	Number of fish
32	14.7	4.60	216
34	15.6	4.59	380
36	16.4	4.56	326
38	17.5	4.60	486
40	18.7	4.67	282

**Table 6.5. Percentage length frequency of *O. argenteus* caught in different mesh size**

Length class (cm)	Mesh size (mm)			
	34	38	40	50
	Percentage frequency			
10-11	2.26	0.00	0.00	0.00
11-12	11.28	0.00	0.00	0.00
12-13	10.53	0.00	0.00	0.00
13-14	15.79	1.24	0.00	0.00
14-15	18.80	6.21	1.34	0.00
15-16	12.78	11.80	2.01	0.00
16-17	10.53	15.53	8.72	1.08
17-18	9.02	8.07	8.05	2.16
18-19	6.77	26.09	34.90	9.73
19-20	1.50	4.97	15.44	9.73
20-21	0.75	18.01	20.81	15.14
21-22	0.00	6.83	6.04	21.62
22-23	0.00	1.24	2.68	28.11
23-24	0.00	0.00	0.00	6.49
24-25	0.00	0.00	0.00	3.24
25-26	0.00	0.00	0.00	2.16



**Table 6.6. Number of *O. argenteus* in different length classes caught in gill nets of different mesh sizes**

Mesh size (mm)	Centre of length class (cm)																Total no. of fish
	10.5	11.5	12.5	13.5	14.5	15.5	16.5	17.5	18.5	19.5	20.5	21.5	22.5	23.5	24.5		
34	6	30	28	42	50	34	28	24	18	4	2	0	0	0	0	266	
38	0	0	0	4	20	38	50	26	84	16	58	22	4	0	0	322	
40	0	0	0	0	4	6	26	24	104	46	62	18	8	0	0	298	
50	0	0	0	0	0	1	2	4	18	28	40	52	12	6	4	167	
Total	6	30	28	46	74	79	106	78	224	94	162	92	24	6	4	1053	

**Table 6.7. Results of the regression analysis between natural logarithms of relative catch ratio against class midpoint for *O. argenteus***

Mesh size combination (mm)	Intercept (cm)	Slope	Regression coefficient	Estimated standard deviation
34 – 38	-10.6334	0.6546	0.8388	1.4069
38 – 40	-7.7619	0.4205	0.6618	1.0063
40 – 50	-17.4128	0.8503	0.9087	2.5223

**Table 6.8. Selectivity estimates of *O. argenteus* for different mesh sizes**

Mesh size (mm)	Optimum selection length (cm)	Selection factor	Number of fishes
34	15.2	4.48	266
38	17.2	4.53	322
40	18.3	4.57	298
50	22.8	4.55	167

**Table 6.9. Percentage length frequency of *P.indicus* caught in different mesh sizes**

Length class (cm)	Mesh size (mm)			
	34	38	40	50
	Percentage frequency			
8-9	6.33	0.00	0.00	0.00
9-10	12.82	3.38	1.93	0.00
10-11	12.82	17.03	6.00	0.00
11-12	31.98	22.03	22.05	11.76
12-13	23.38	35.54	26.11	16.18
13-14	4.22	15.27	17.99	11.76
14-15	2.11	3.38	19.92	16.18
15-16	4.22	3.38	4.06	24.02
16-17	0.00	0.00	1.93	20.10
17-18	0.00	0.00	0.00	0.00
18-19	2.11	0.00	0.00	0.00

**Table 6.10. Number of *P.indicus* in length classes caught in different mesh size**

Mesh size (mm)	Centre of length class (cm)										Total no. of fish	
	8.5	9.5	10.5	11.5	12.5	13.5	14.5	15.5	16.5	17.5		18.5
34	42	85	85	212	155	28	14	28	0	0	14	663
38	0	23	116	150	242	104	23	23	0	0	0	681
40	0	10	31	114	135	93	103	21	10	0	0	517
50	0	0	0	24	33	24	33	49	41	0	0	204
Total	42	118	232	500	565	249	173	121	51	0	14	2065

**Table 6.11 Result of the regression analysis between natural logarithms of relative catch ratio against class midpoint for *P.indicus***

Mesh size combination (mm)	Intercept (cm)	Slope	Regression coefficient	Estimated standard deviation (cm)
34 – 38	-6.0958	0.5373	0.7577	2.0933
38 – 40	-7.4082	0.5800	0.7836	1.3954
40 – 50	-11.6997	0.7842	0.844	2.3219

**Table 6.12 Selectivity estimates of *P. indicus* for different mesh size**

Mesh size (mm)	Optimum selection length (cm)	Selection factor	Number of fish
34	10.7	3.15	663
38	12.2	3.22	681
40	13.2	3.30	517
50	16.6	3.32	204

**Table 6.13. Species composition of catch in small mesh gill nets**

Family/Genus	Species	Local name	Common name
Sciaenidae	<i>Johnius sp.</i>	Kuttan	Jew fish
	<i>Otolithus cuvieri</i>	"	"
	<i>Johneops sp.</i>	"	"
Clupidae	<i>Sardinella longiceps</i>	Chala	Oil sardine
	<i>Kovala coval</i>	Velloori	White sardine
	<i>Dussumeria hasselti</i>	Kolachi	Rainbow sardine
	<i>S.gibbosa</i>	Karichala	Indian sprat
	<i>Pellona sp.</i>	Kannathi	Indian herring
Mugilidae	<i>L. cephalus</i>	Kanampu	Mullet
	<i>L. parsia</i>	"	Gold spot mullet
Cyanoglossidae.	<i>Cyanoglossus macrostomus</i>	Manthal	Flat fish
Engraulidae	<i>Thryssa malabarica</i>	Kavu manungu	Malabar anchovy
	<i>Thryssa mystax</i>	Nedumanungu	Mustached anchovy
	<i>Stolephorus indicus</i>	Kozhuva	Indian anchovy
	<i>S. commersoni</i>	Nethal	Commerson's anchovy
Penaeidae	<i>Penaeus indicus</i>	Naran	Indian white prawn
	<i>Metapenaeus dobsoni</i>	Poovalan	Flower tail prawn
	<i>M.affinis</i>	Kazhanthan	Brown shrimp
	<i>M.monoceros</i>	Choodan	Brown shrimp
Leiognathidae	<i>Leiognathus bindus</i>	Nalla mullan	Orange finned pony fish
	<i>L.insidiator</i>	Chakkara mullan	Slender barred ponyfish
	<i>Secutor egulus</i>	Mullan	Pony fish
Polynemidae	<i>Eleutheronema tetradactylum</i>	Vazhmeen	Indian halibut
Sillaginidae	<i>Sillago sihama</i>	Kathiran	Indian whiting
Scombridae	<i>Scombermorus commersoni</i>	Champan	Seer
	<i>Rastralliger kanagurta</i>	Aila	Mackerel
Carangidae	<i>Megalaspis cordyla</i>	Vankada	Horse mackerel
	<i>Caranx sp.</i>	Vatta	Shad
	<i>Parastromateus niger</i>	Karuthavoli	Black pomfret
Lactaridae	<i>Lactarius lactarius</i>	Parava	White fish
Stromateidae	<i>Pampus argenteus</i>	Avoli	White pomfret
Dorosomidae	<i>Anadontostoma chacunda</i>	Thodi	Gizzard fish
Theraponidae	<i>Therapon jarbua</i>	Keeri	Zoned perch
Ambassidae	<i>Ambassis sp.</i>	Nanthan	Glassy perchlet
Hemiramphidae	<i>Hemiramphus sp.</i>	Kolan	Half beak
Gerridae	<i>Gerres filamentosus</i>	Pranjil	Long rayed silver biddy
Scoliodon sp.	<i>Scoliodon sp.</i>	Sravu	Shark
Neptunus sp.	<i>Neptunus sp.</i>	Njandu	Crab

**Table 6.14. Proportion of juveniles caught in different mesh sizes**

Species	% juveniles in total catch								Length at first maturity (cm) and Source
	Mesh size (mm)								
	30	32	34	36	38	48	50	52	
<i>S.longiceps</i>	63	40	12	3	0	0	0	0	15-16 Bal &Rao, (1984)
<i>R.kanagurta</i>	100	100	100	97	84	0	0	0	22.4 Pradhan, (1956)
<i>O.argenteus</i>	92	71	60	0	0	0	0	0	13-14 Bhusari, (1971)
<i>Leiognathus sp.</i>	-	23	0	5	-	-	-	-	8.7 Bal&Rao, (1984)
<i>M.cordyla</i>	100	100	100	100	100	72	45	0	22 Bal&Rao, (1984)
<i>S.commersoni</i>	-	100	100	100	100	-	-	-	75 Devaraj, (1977)
<i>E.tetradactylum</i>	-	100	100	100	100	100	100	100	6-39 Kagwade, (1970)

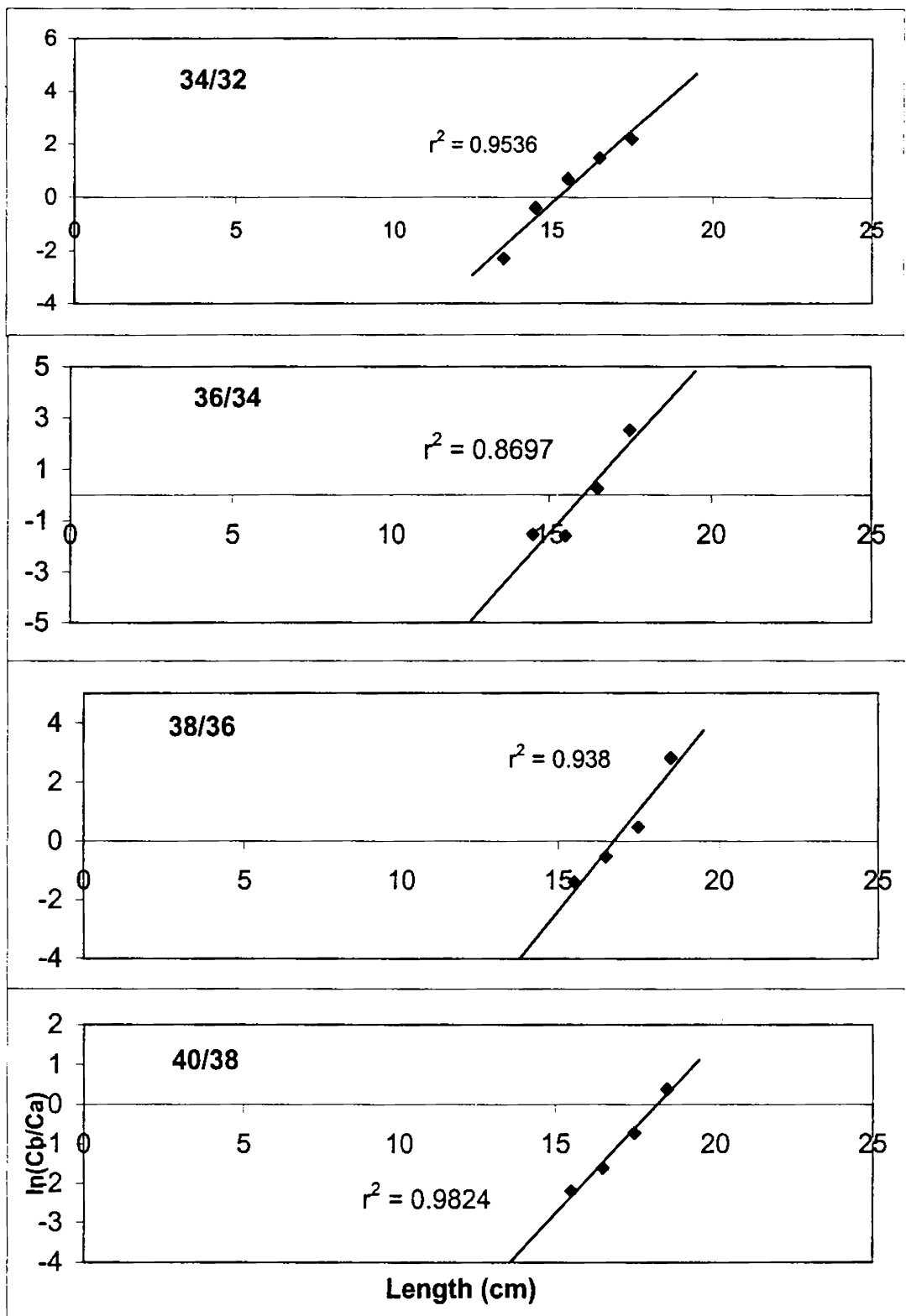
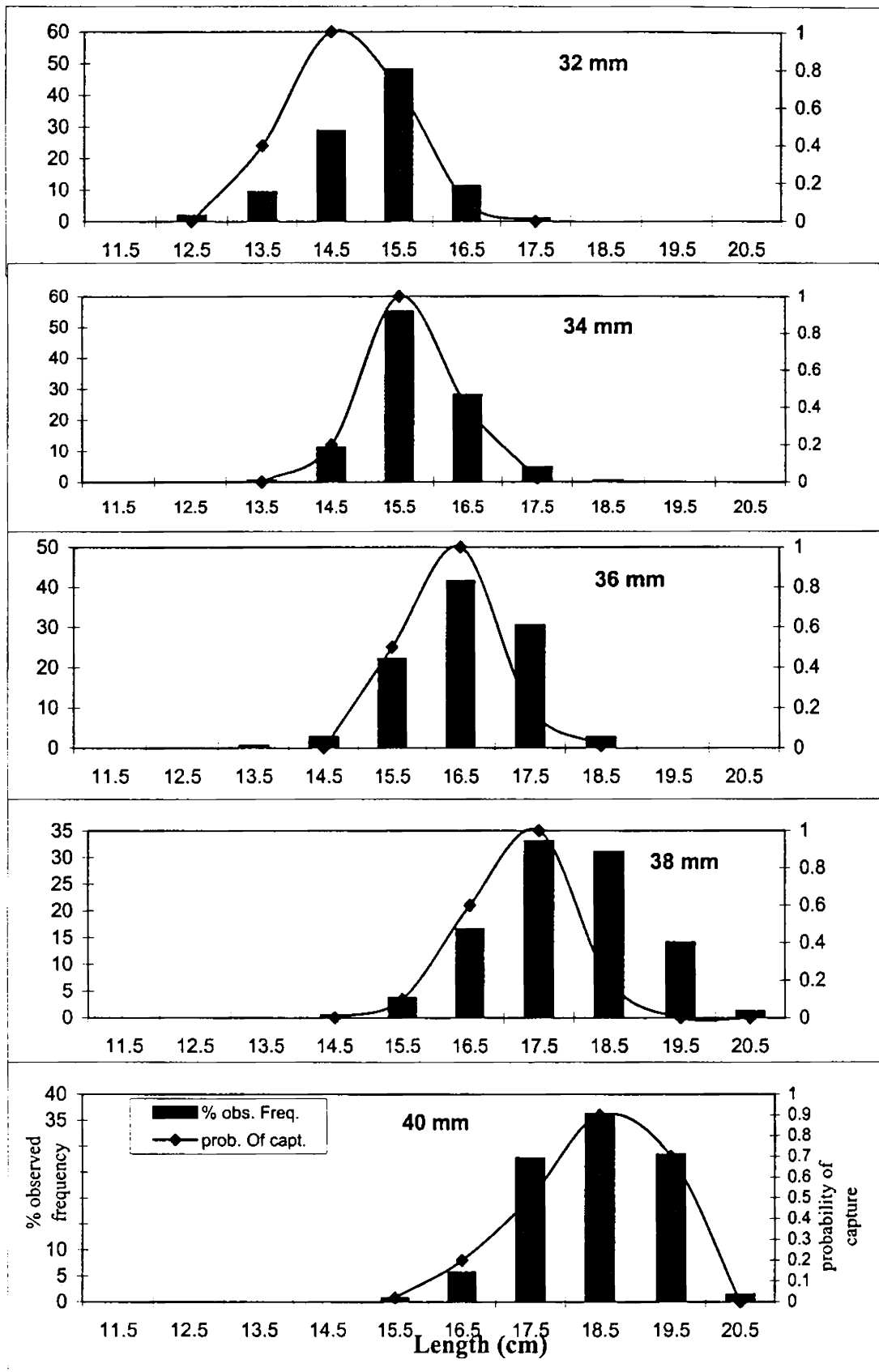


Fig.6.1. Points  $\ln(Cb/Ca)$  and lines of regression from the results of *S. longiceps* catches with pairs of gill nets





**Fig.6.2. Observed and estimated selectivity curve of *S. longiceps* in different mesh sizes**

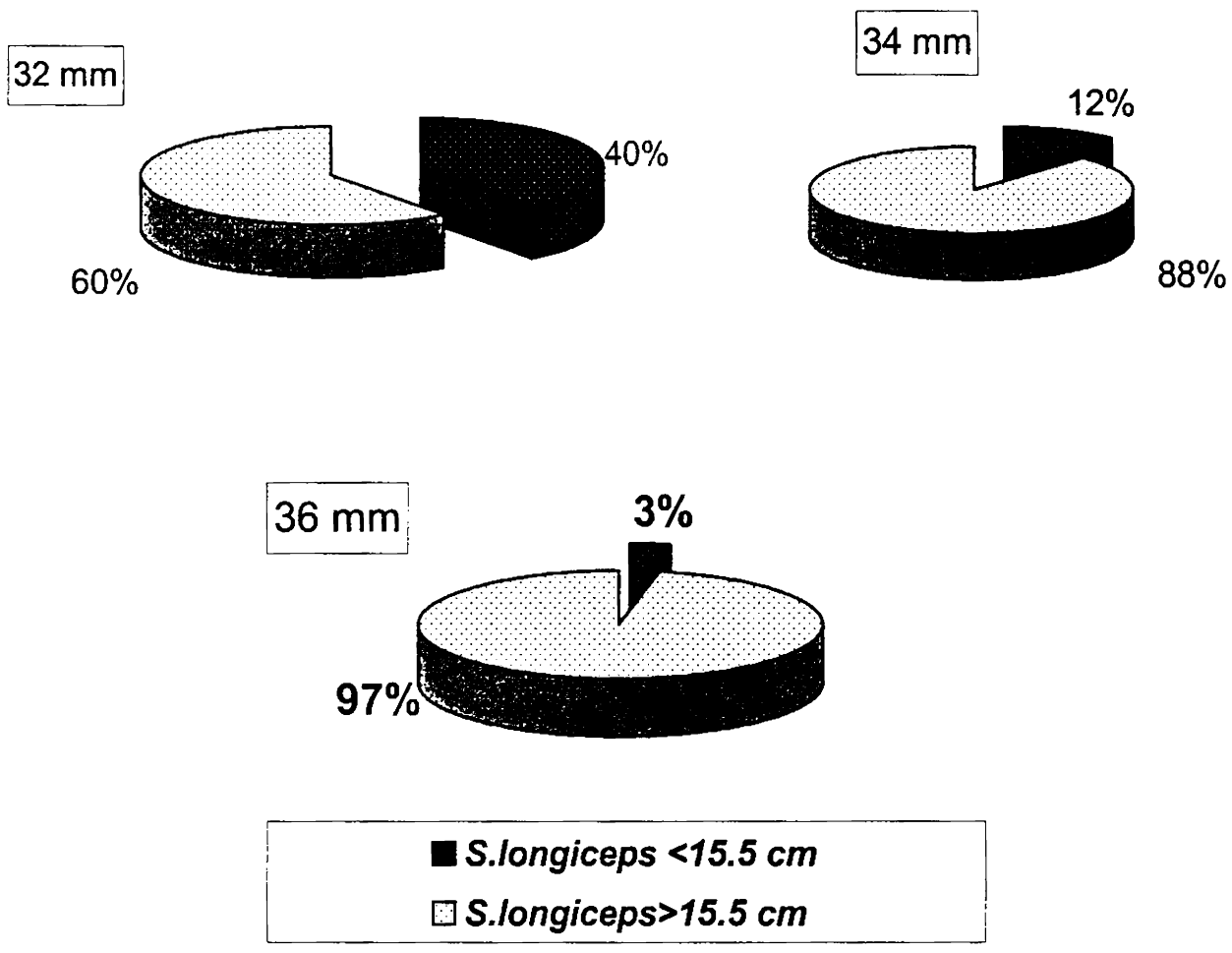
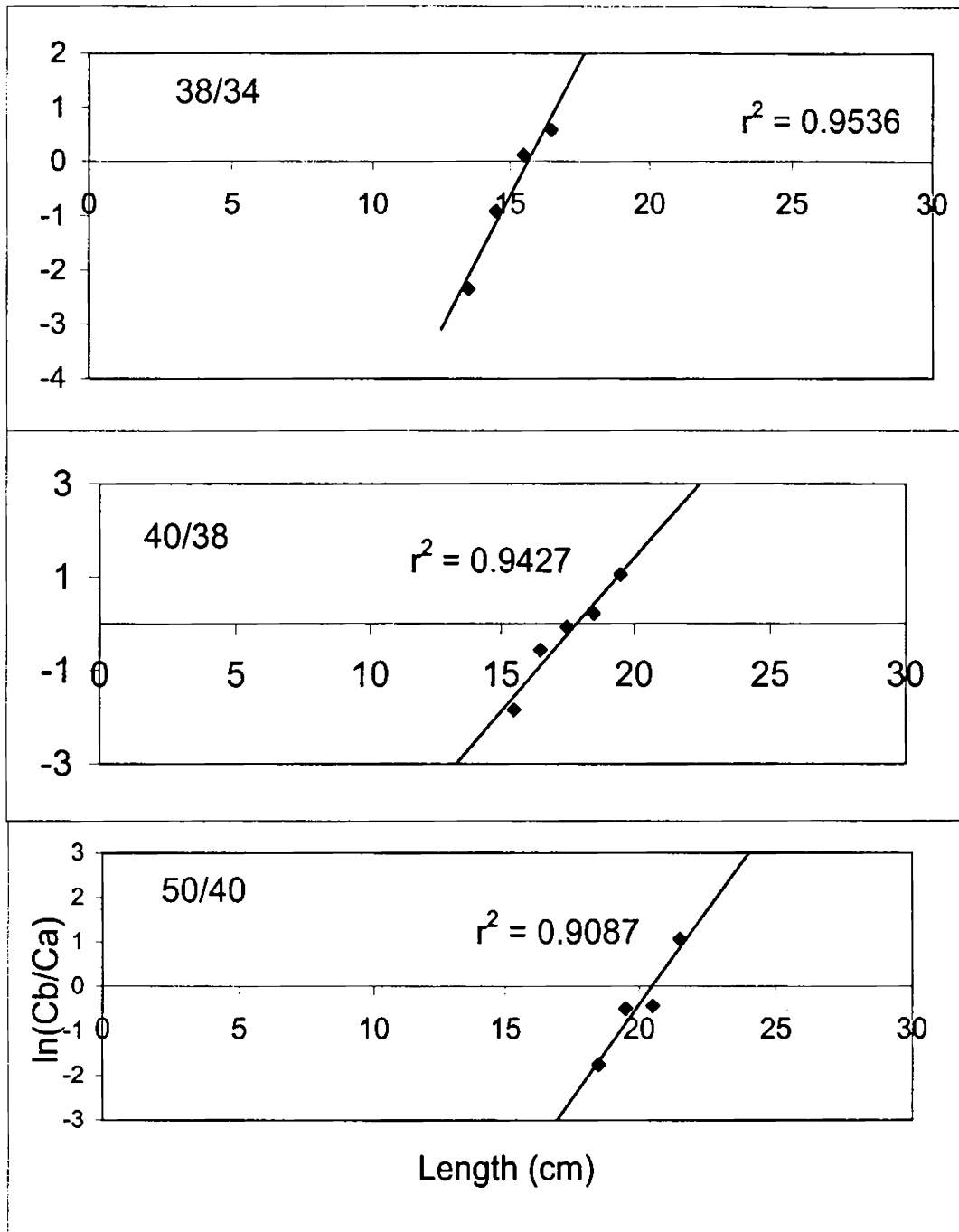


Fig.6.3. Undersized *S. longiceps* caught in different mesh sizes



**Fig.6.4. Points  $\ln(\text{Cb/Ca})$  and lines of regression from the results of *O. argenteus* catch with pairs of gill nets**

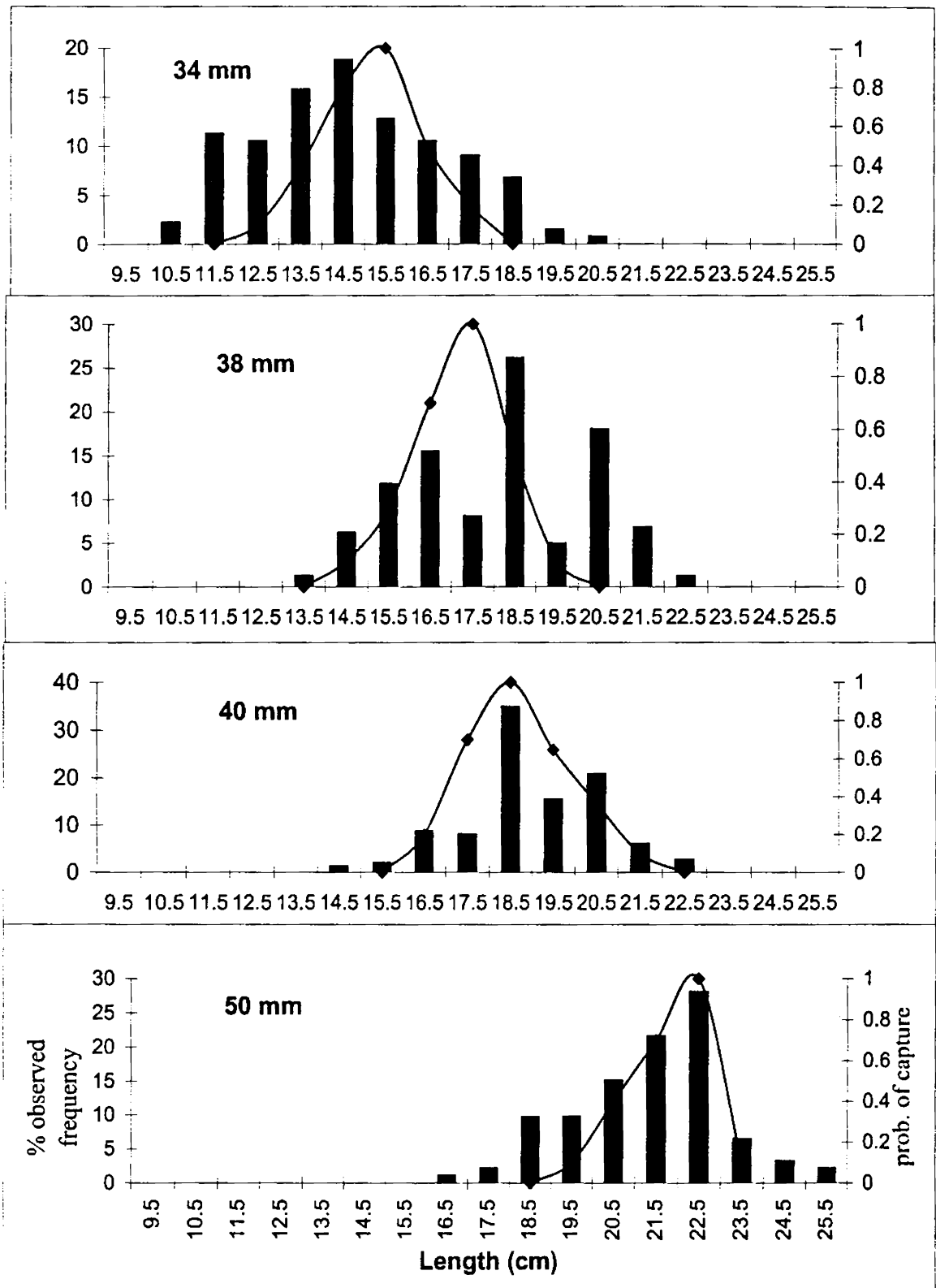
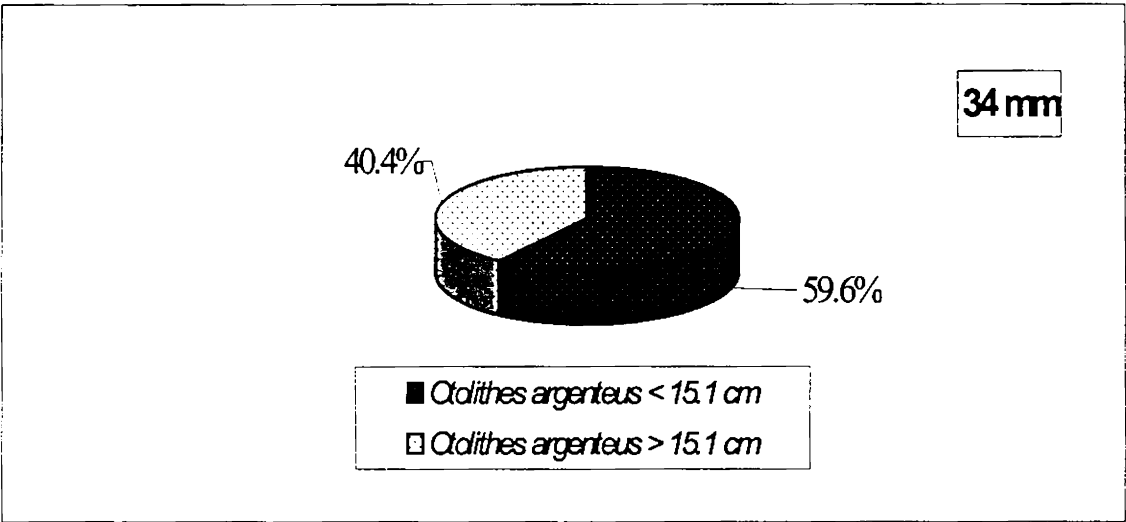
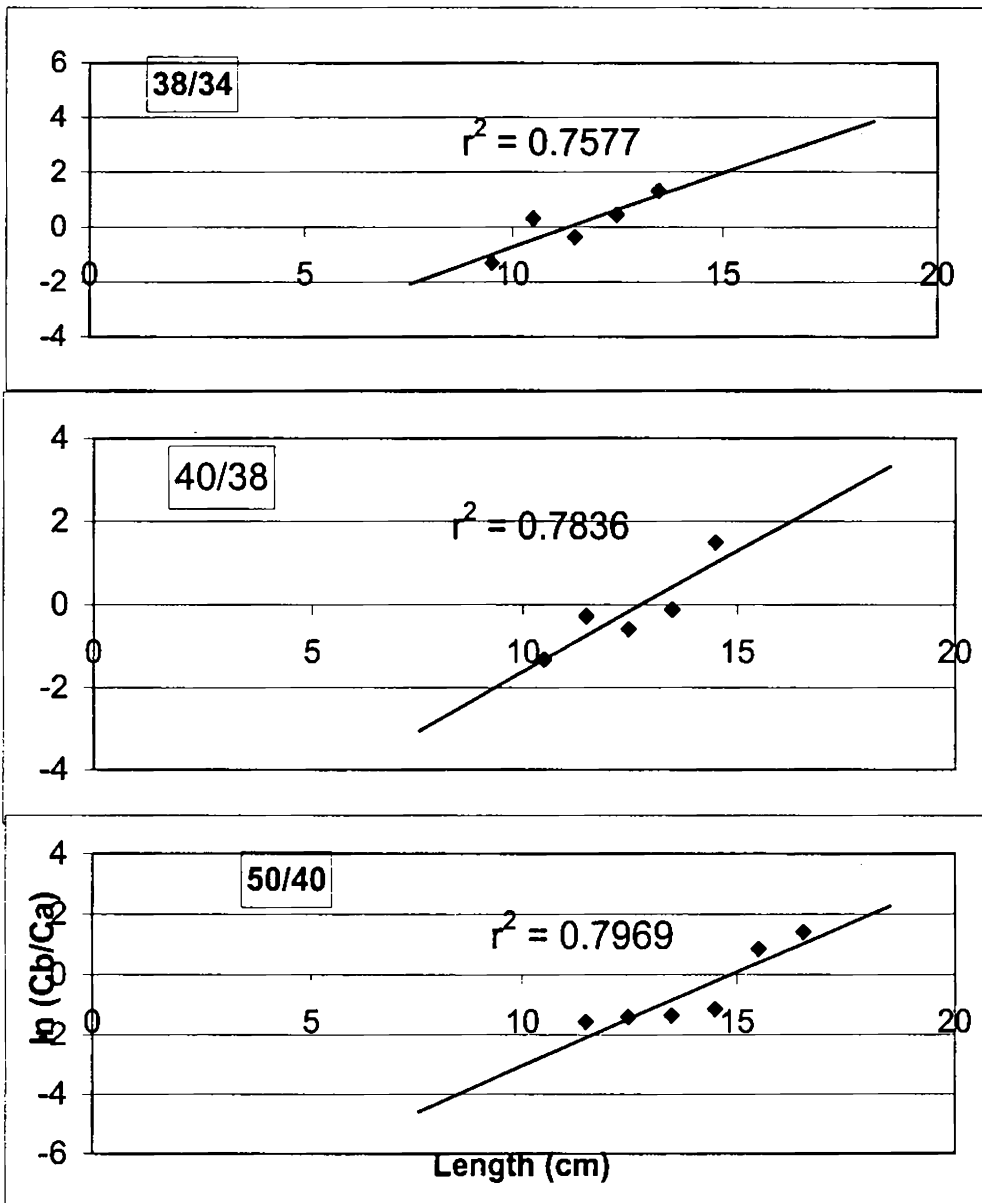


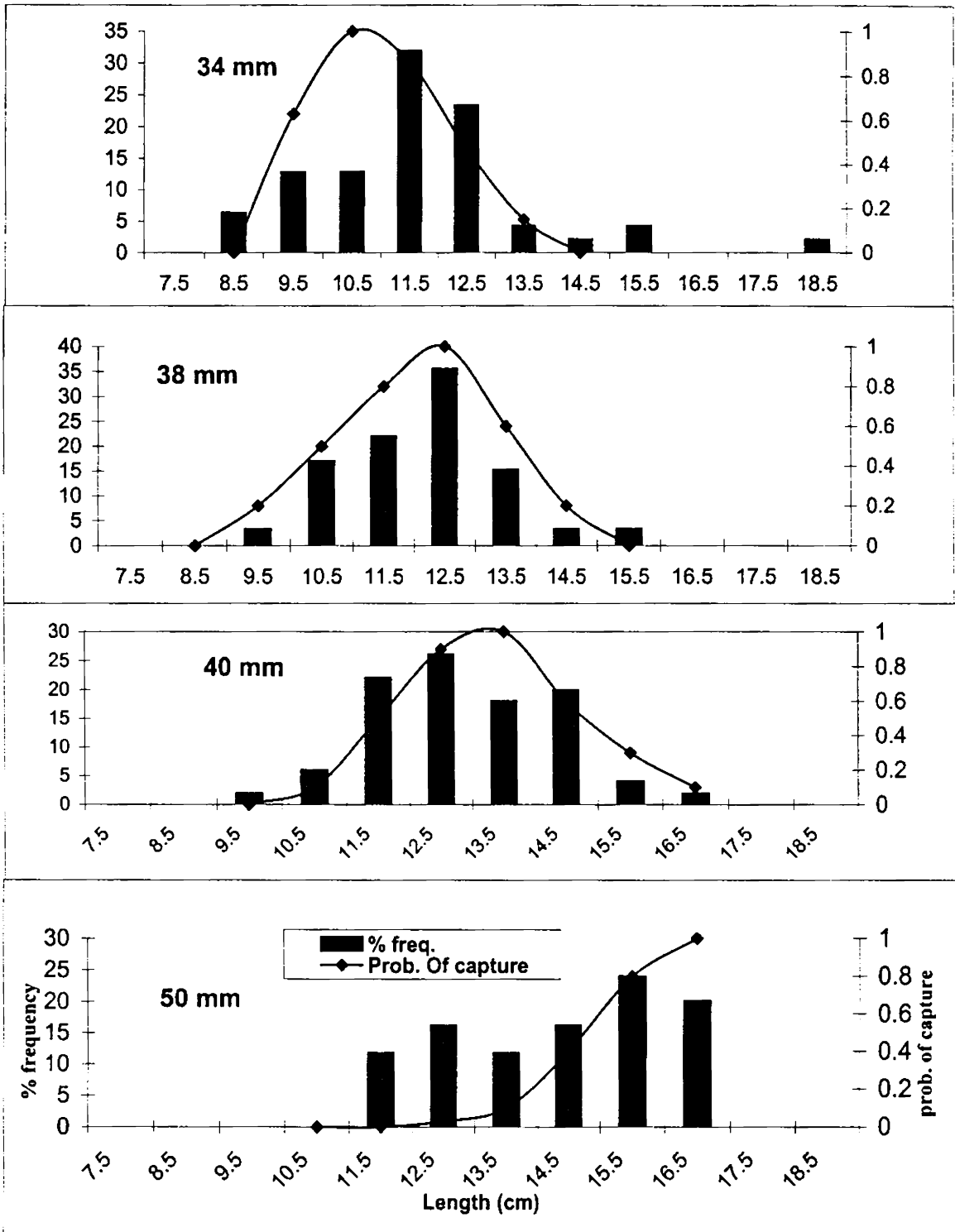
Fig. 6.5. Observed and estimated selectivity curves of *O. argenteus* in different mesh sizes



**Fig. 6.6. Undersized *O. argenteus* caught in 34 mm mesh**



**Fig.6.7 Points  $\ln(Cb/Ca)$  and lines of regression from the results of *P.indicus* catches with pairs of gill nets**



**Fig. 6.8** Observed and estimated selectivity curve of *P.indicus* caught in different mesh size

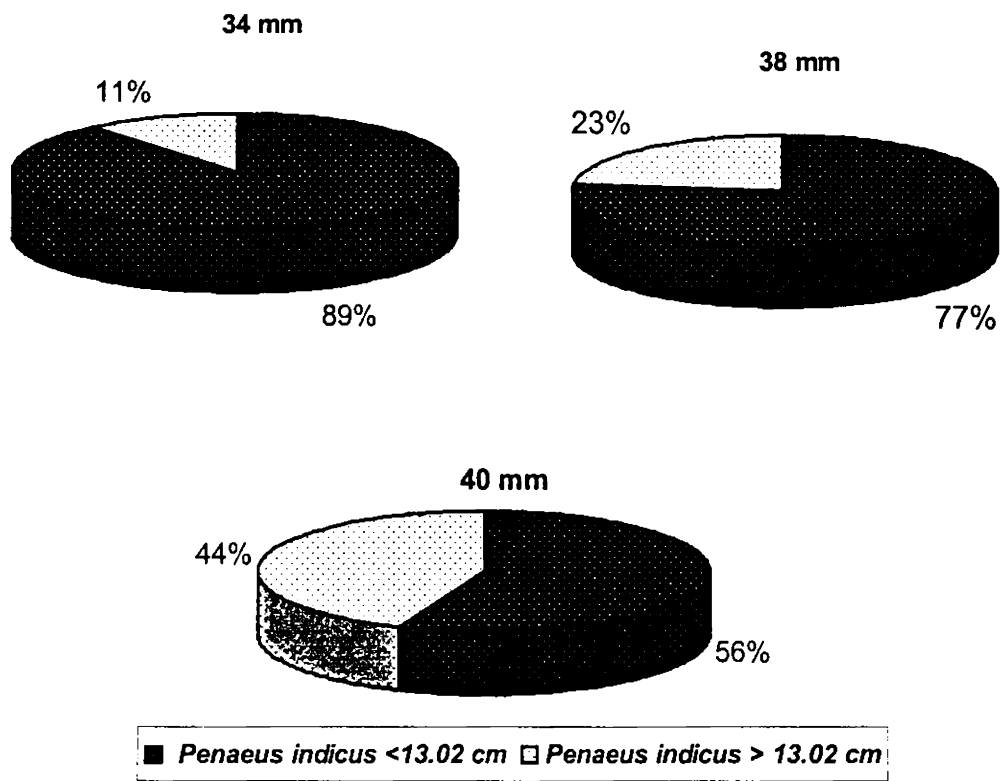
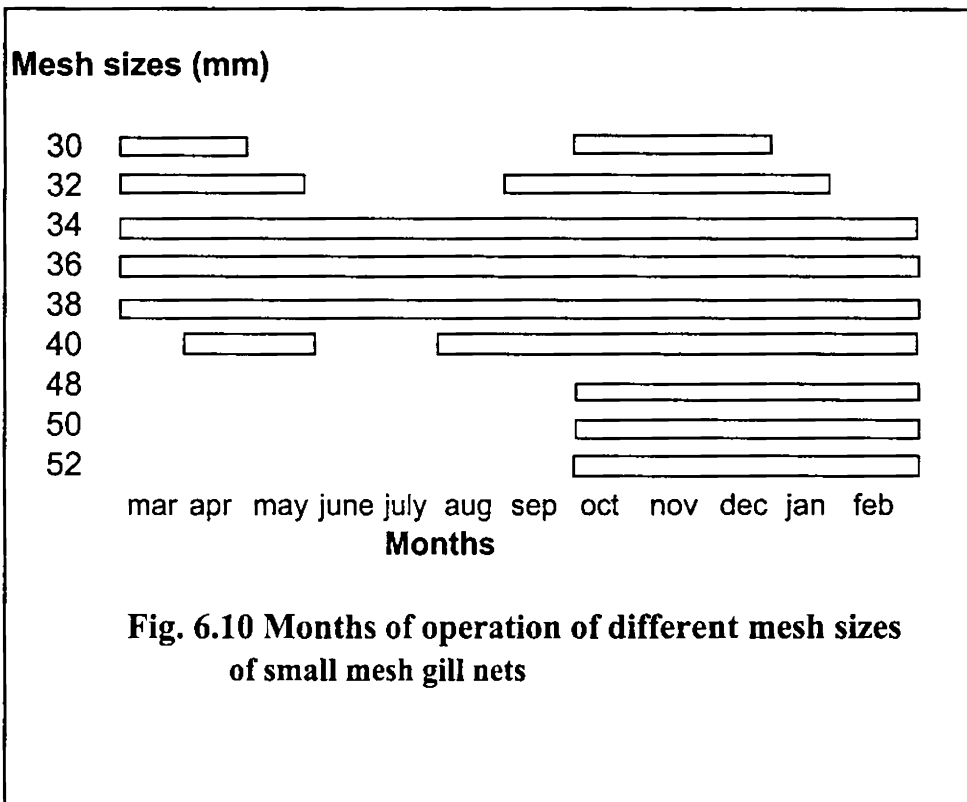
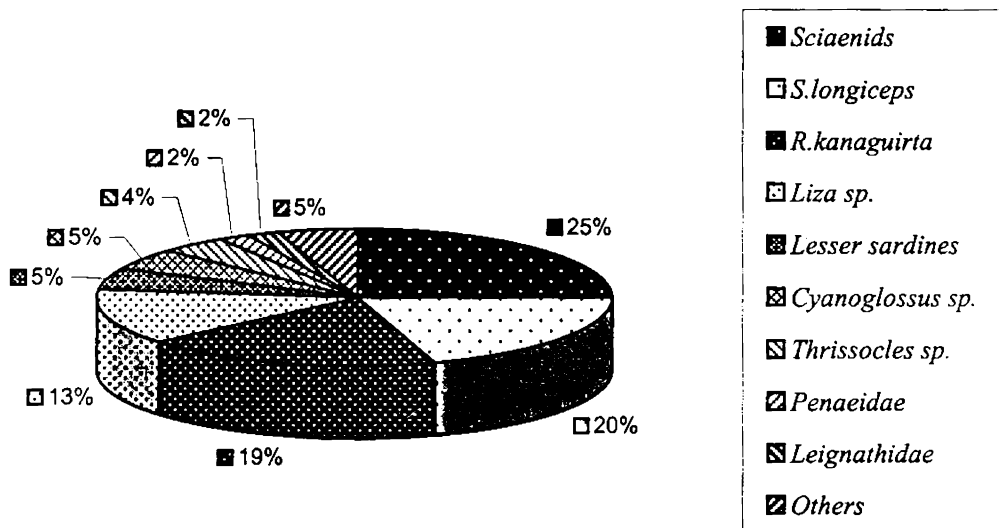


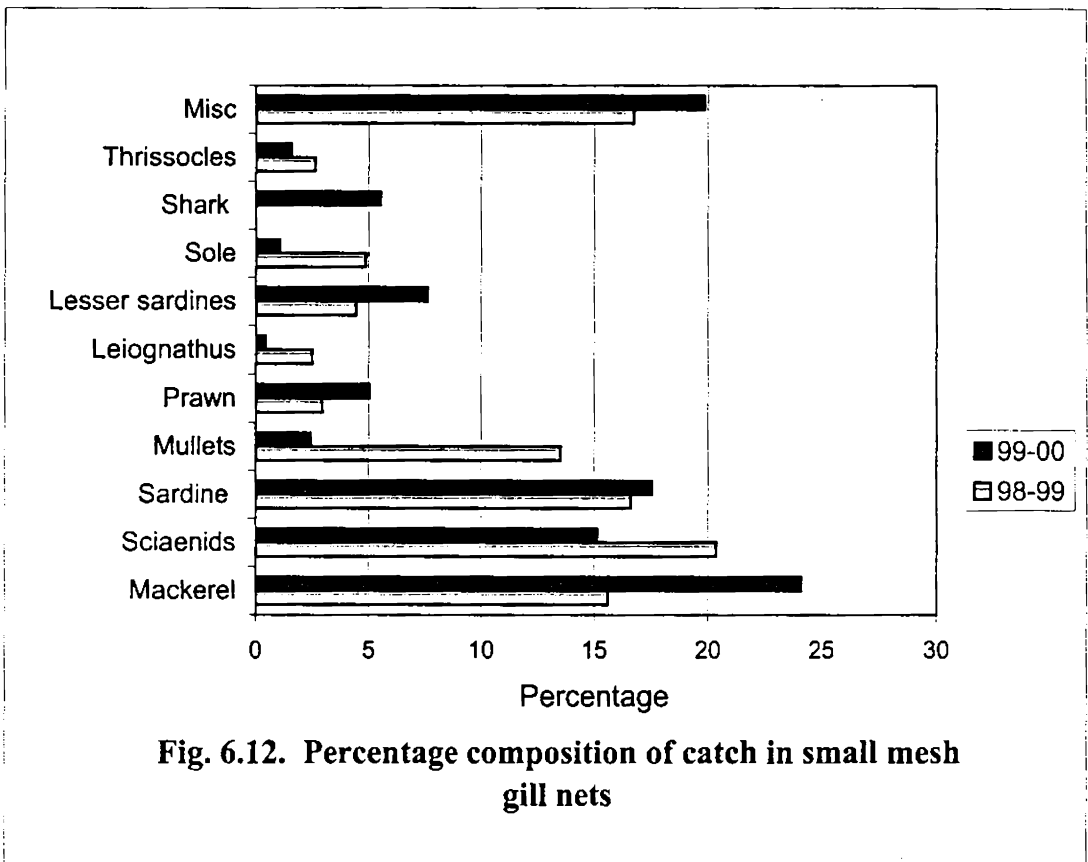
Fig: 6.9. Undersized *P. indicus* caught in mesh sizes of 34, 38 and 40 mm

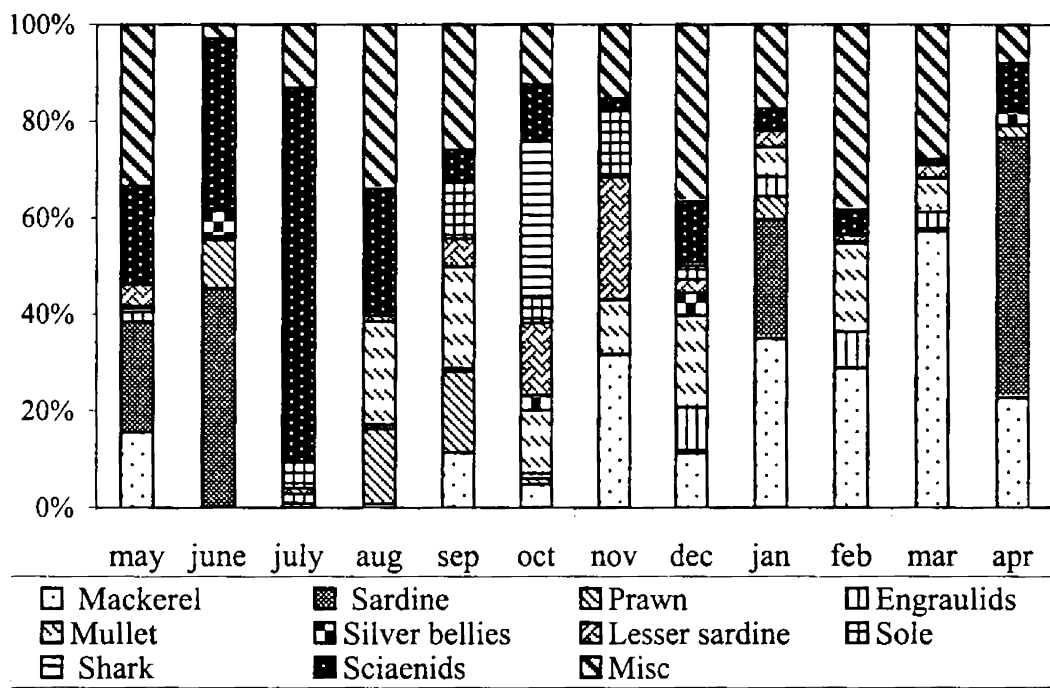






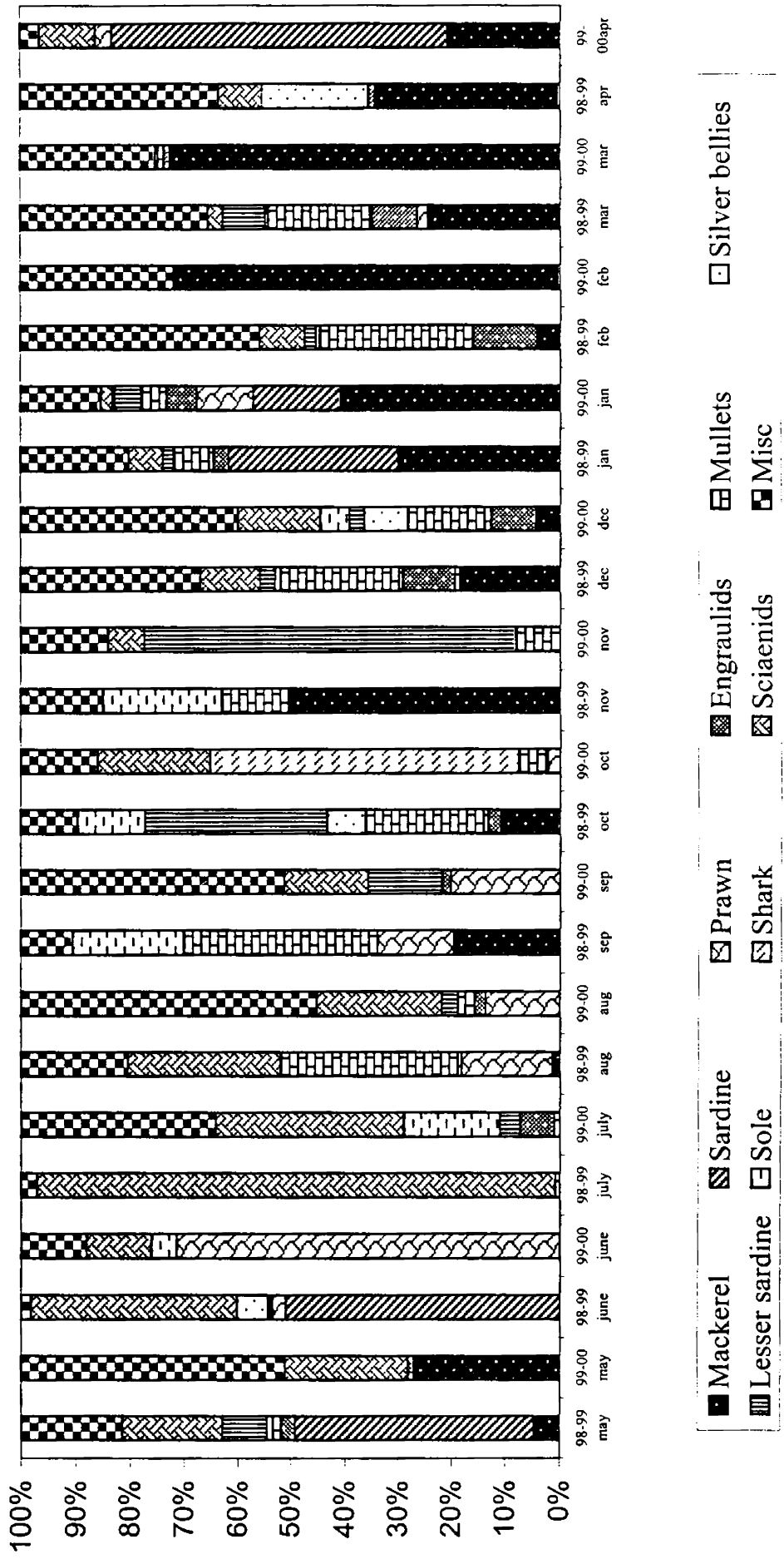
**Fig.6.11. Percentage composition of catch in small mesh nets**





**Fig. 6.13. Monthly species composition**

**Fig. 6.14 Monthly species composition in small mesh gill nets during 1998-99 and 99-00**



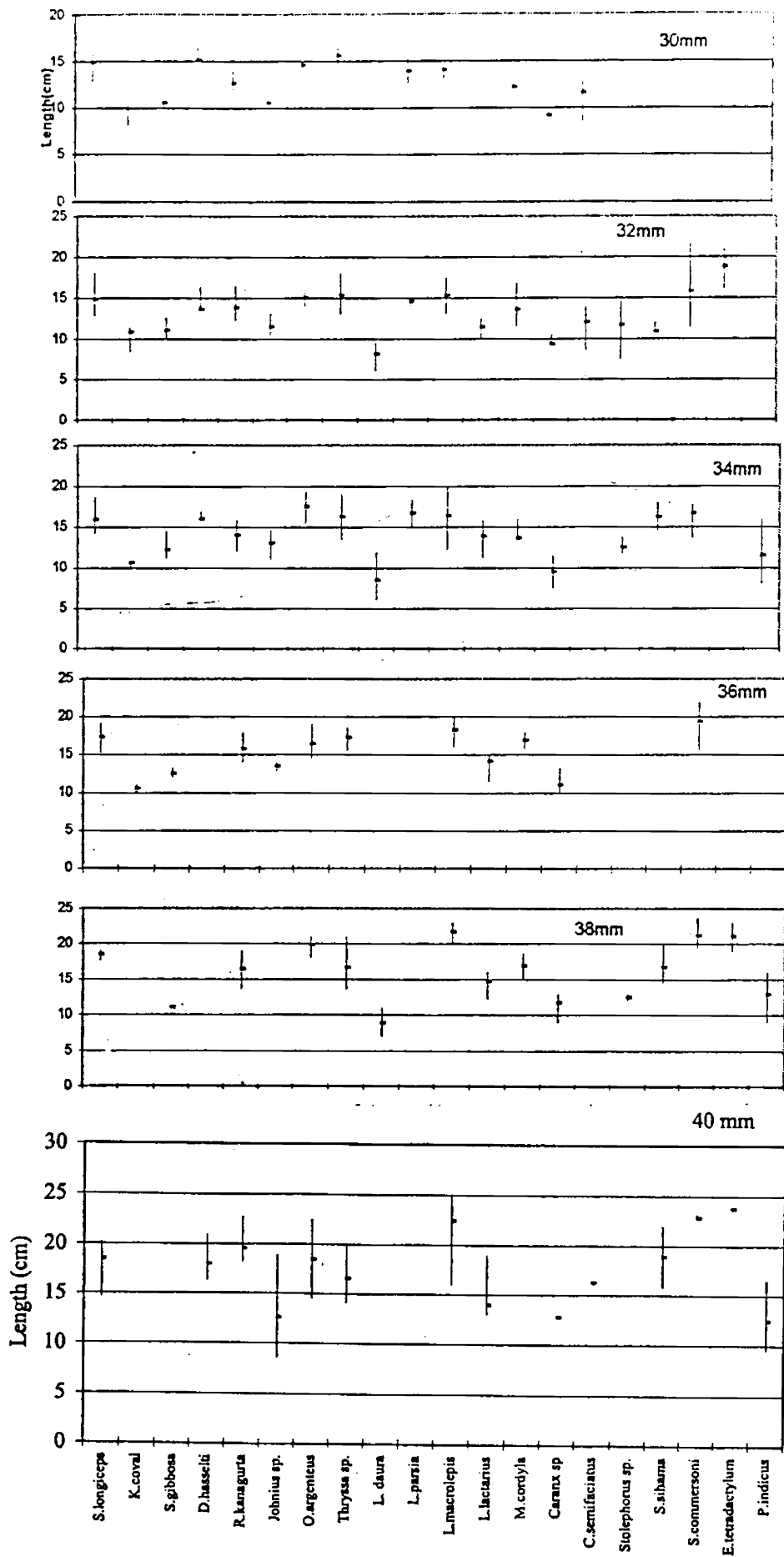


Fig. 6.15. Length range and mean of fishes caught in mesh sizes of 30-40 mm

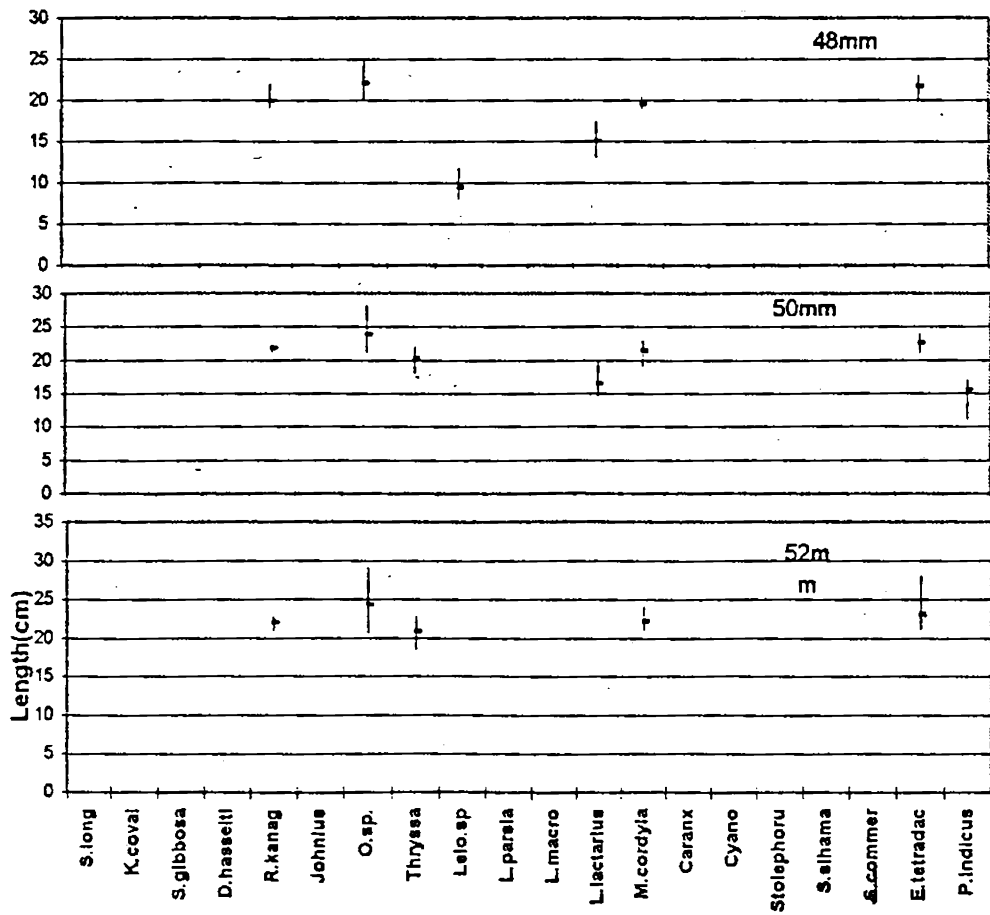


Fig. 6.16. Length range and mean of fishes caught in mesh sizes of 48-52 mm

## **Chapter 7**

# **Techno-economic Analysis**



## Chapter 7

### TECHNO-ECONOMIC ANALYSIS

#### 7.1. Introduction

In the fisheries sector today, the primitive non-motorised country craft exists as a distinct enterprise along with highly sophisticated factory vessels that harvest and process fish on board. The different technologies and the associated socio-economic relations often lead to inter-enterprise clashes. The basic cause behind the coastal unrest lies in the system of 'open access fisheries' under which one man's gain is another man's loss.

Better technologies obviously have a better access to fishery resources; but these involve higher cost. A technology can be considered appropriate and successful only if it lowers production cost per unit of catch or raises productivity. Consequently, it becomes imperative to study and monitor the economic performance of different fishing enterprises.

The pattern of capital investment, crew size, sharing system, soaking time (time during which the net is actually in water) and actual fishing time differ in different fishing systems. The technical

and economic efficiency of a system are equally important. From a fishing technologist's point of view, the superior technical performance and from an economist's point of view, the economic behaviour or economic health of the system especially in the long run is very important. Hence a technically superior fishing method with high earning capacity is the ideal one.

The techno-economic efficiency of different fishing systems is an important decisive factor in the allocation of scarce resources such as capital. The sustainable development of fishing through co-existence of different sectors needs basic information on their comparative efficiency. The comparative technical and economic performance of different fishing systems in different parts of the world have been discussed by many (Yater, 1982; Librero *et al.*, 1985; Panayotou *et al.*, 1985; Tokrishna *et al.*, 1985; Fredericks and Nair, 1985; Khaled, 1985 and Jayantha and Amarasinghe, 1998). In the Indian context, techno-economic aspects of purse seine was studied by Verghese (1994), Mukundan and Hakkim (1980), Panikkar *et al.*, (1993), and Shibu (1999). Iyer *et al.*, (1985), Devaraj and Smitha (1988), John (1996), and Shibu (1999) investigated the economics of trawling.

The gill net fishing being a low energy fishing technique was favoured in recent years in the context of alarming fuel cost. Adoption of new technology in the gill net fishing of Kerala was mainly in the form of (1) adoption of synthetic fibres in place of vegetable fibres and (2) adoption of powered vessels for propulsion. Before 1950 this fishing was completely the affair of non-motorised fishermen. The mechanisation programme in 1950s and motorisation programme in 1980s witnessed the emergence of three distinct sectors viz., non-motorised, motorised and mechanised in marine fisheries. These three subsectors should be given equal priority while conducting cost and earnings studies (Sehera *et al.*, 2000). The impact of these technologies on the production front and in the income levels of fishermen needs special investigation. Attempts made in this line were primarily by Kurien and Willmann (1982), Balan *et al.*, (1989) and Anon (1991). The study by Kurien and Willmann was before the start of motorisation phase. Anon (1991) examined the changes in the fish economy of the lower southwest coast beyond 1981 for assessing the techno-economic viability of the new motorised sector and the remnants of the non-motorised artisanal fishing units. A comparison of these three subsectors was studied by

Balan *et al.*, (1989). Since then another decade had gone by and many changes have taken place in this sector.

Given that levels of technologies tend to differ in an enterprise and that these tendencies are not a temporary feature but an inherent behavioural characteristic of primary sectors such as fisheries, it becomes important to evaluate the economic performance of different grades of technologies to assess their economic health. The present study is an empirical attempt in this direction.

## **7.2. Materials and Methods**

### **7.2.1. Selection of Technologies**

In order to evaluate the comparative technical and economic efficiency, four different technologies were identified in the gill net sector, based on the level of technology adopted in fish harvesting and target resource. These are

- i. Non-motorised sector employing small mesh gill nets;
- ii. Motorised small mesh sector employing small mesh gill nets;
- iii. Motorised large mesh sector employing large mesh gill nets; and
- iv. Mechanised large mesh sector employing large mesh gill nets.

These sectors are classified in this study as Technology I, II, III, and IV respectively. Technology I, is a sector using 10'(3.03 m) to 25' (7.6 m) length over all (LOA) craft which included kattamarams, plank built canoes and dugout canoes, operating gill nets of less than 12 kg mostly targeted for sardine, mackerel, prawn, mullets, pomfret, white sardine, anchovy and other miscellaneous fishes.

Technology II comprises of plank transform canoes, dugout canoes and kattamaram – of LOA 28' (8.5 m) to 30' (9.1 m) fitted with 9.9 or 15 hp outboard engines using gill nets weighing 10 to 30 kg operated for mackerel, sardine, white sardine, anchovy, and pomfret.

Technology III comprises of plywood canoes, dugout canoes and plank built canoes of LOA 25' (7.6 m) to 40' (12.1 m) fitted with 9.9 or 15 hp outboard engines using large mesh drift gill nets of 300 to 400 kg targeted for seer, tuna and shark.

Technology IV represents mechanised wooden fishing vessels of 30' (9.1 m) to 45' (13.6 m) LOA fitted with 60 to 90 hp inboard diesel engines using drift gill nets of weight 300 to 600 kg, targeted for seer, tuna and shark.

### **7.2.2. Selection of Centres and Sample Units**

This study is based on empirical investigation carried out in five important landing centres (Chapter 2, Fig. 2. 1) located in Thrissur, Ernakulam and Alappuzha districts representative of different gill net sectors. Of these, Thalikulam falls in Thrissur district, Kochi fisheries harbour, Beach Road, and Chellanam belonging to Ernakulam district and Chettikad in Alappuzha district. The centres, Beach road represented technology I, Chellanam technology II, Thalikulam and Chettikadu, technology III and Kochi fisheries harbour technology IV.

The fishing unit was taken as the sampling unit. A detailed sample frame is depicted in Table 2.1 (Chapter 2). A total of 45 units from five centres representing the four technologies were selected randomly as sample units for the study.

### **7.2.3. Fishing Practices**

Each centre/sector has its own peculiar fishing practices with respect to the resource availability and geographic conditions.

### **Small Mesh Gill Nets**

(a) Non motorised sector: In Beach road, marine gill net fishing is carried out through out the year. It represents 13.8 % of the district's exclusively sea going non-motorised gill net units.

(b) Motorised sector: The small meshed gill net sector has a motorised category also. Under this, gill net units targeting mackerel were selected for the study. Chellanam fishing centre, which represents 16.5 % of the motorised small mesh gill nets of Ernakulam district, is selected. This category of gill net fishing is seasonal operating 5 to 6 months a year.

### **Large Mesh Gill Nets**

Gill nets operated for seer and tuna were selected representing large mesh gill net sector. This sector comprised of a motorised and mechanised subsector.

(a) Motorised sector: This represented gill net units operated for seer and tuna from motorised plywood canoes. To study this sector, two important centres (1) Thalikulam and (2) Chettikad were selected.

(b) Mechanised sector: Kochi fisheries harbour from where 82 % of the total mechanised gill net units of the state are operated was

selected. The fishermen from Colachal, Tamil Nadu operating at Kochi almost exclusively represented this particular sector. The boats concentrate on gill netting, during April to October and from November onwards bigger boats especially of LOA above 35' (10.6 m) concentrate on line fishing also. The gill net operations during the first year of this study, 1998-1999 were mainly of two and three day operations with occasional one day and four day operations. During the second year i.e. 1999-2000, the fishing pattern shifted to 4, 6 and even 14 day operations. Data from 10 units, which carried out 3 day and occasionally 4 day fishing in both the years, was finally selected for analysis. These vessels were mainly concentrating on gill net fishing.

#### **7.2.4. Data Collection and Analysis**

Two pre-tested interview schedules were used for collecting the investment and operational details of the selected fishing units viz. schedule I and II. Schedule I was used to gather information relating to the dimensions of the gear, capital investment, fixed costs and sources of raising capital of each unit. This information was collected only once at the initial stage of the study. Schedule II was used on a weekly basis to collect the operational cost, fishing time, fishing conditions, catch composition, revenue and the repair and



maintenance costs from each unit. This was collected for two successive fishing years, from May 1998 to April 2000. Data were collected by direct observation and by interviewing the fishermen during weekly visits to the landing centers. Such data were cross checked with the operators of the units and with commission agents/middlemen in order to ensure reliability.

The collected data was analysed with reference to technical and economic efficiency. Under technical efficiency indices such as effort (depth of fishing, volume of net used, fishing days and fishing time) and productivity (catch per unit effort and catch value per unit effort) were worked out and compared. The economic efficiency was analysed by standard indices such as return on investment, internal rate of return (Varshney and Maheshwari, 1981), factor productivity and productivity of fuel.

### **7.3. Results and Discussion**

#### **7.3.1. Technical Efficiency**

##### **7.3.1.1. Effort**

Fishing effort is a composite input having component elements such as capital, labour, material and time spent for fishing

(Panayotou, 1985). In this study, the effort expended in different systems was compared. The indices selected to assess the efforts were depth of fishing, volume of net used, fishing days and fishing time (soaking time, actual fishing time and total fishing time) and total fishing effort.

### **Depth of Fishing:**

Average depth of fishing of each category of gill net fishing system is depicted in Fig. 7.1. Non-motorised sector (technology I) fished at an average depth of 6.79 m whereas motorised small mesh sector (technology II) at a depth of 27.63 m, motorised large mesh sector (technology III) at a depth of 34.87 m and mechanised large mesh sector (technology IV) at a depth of 59.89 m. The depth ranges of the respective sectors were 1.6 to 11.2, 20 to 39, 16 to 59 and 27 to 300 m respectively.

The operation of non- motorised gill net units was restricted to 12 m depth zone. This showed no significant difference from the conditions of 1980-81 (Kurien and Willmann, 1982) and of 1988-89 (Anon, 1991).

Balan *et al.*, (1989) reported that the depth of operation of motorised sector did not increase as expected and that there was good

potential of catfish, seer fish, ribbon fish and sharks in the 20-50 m depth range accessible to the motorised boats. Anon (1991) also reported that motorised units did not venture into deeper water beyond 20 m depths as expected. But the present study indicated that the motorised gill nets (technology II and III) ventured well beyond 20 m but within the 50 m depth zone, in search for new fishing grounds. Technology III occasionally operated in areas beyond 50 m depth.

The depth of operation of mechanised units (technology IV) also was extended beyond the earlier grounds. In 1980-81 the average depth of operation was 32 m (Kurien and Willmann, 1982) and during 86-87 it was 20 to 50m (Jayaprakash, 1989). The present average depth of operation of technology IV was approximately 60 m but ranged from 27 to 300 m. Thus the improvement in level of technology resulted in an increase in effort and operational range.

### **Volume of Net**

Fig. 7.2 depicts the effort in terms of average volume of net used per trip in each technology. The figure clearly showed that there was progressive increase in effort with the level of technologies. The operation in deeper and distant grounds by technologies II to IV

necessitated longer and deeper nets to exploit specific resources. Motorisation and mechanisation also eased the physical strain of rowing and hence fishermen were in a position to carry more nets. Besides, the bigger vessels provided space to carry more volume of nets.

### **Fishing Days and Trip Time**

It is considered that, as the level of technology improves, it is possible to increase the fishing effort and period of stay at sea. Hence these variables were compared between different technologies. Table 7.1 shows the average number of fishing days per year in each sector. The non- motorised sector had maximum fishing days. They used a variety of gill nets depending on the season.

The reasons for break in fishing operations differed between technologies (Table 7. 2). Bad weather was the main reason for not going for fishing in technology I. However, technology II, III and IV viz. motorised and mechanised sector considered the expected catch a major factor deciding to venture into fishing as cost on fuel and bata are compulsory items of cash input. Hence fishermen operating technology II, III and IV hoped for a minimum of catch while going for fishing. In the case of technology III, bad weather contributed

significantly to the reasons for not venturing for fishing. This was due to the fact that this sector carried night fishing and the depth of operation was comparatively higher than technology II viz. 17 to 59 m and venturing into such distant areas during rough weather at night with less than 30' (9.09 m) LOA open decked vessel fitted with 9.9 hp outboard engine was risky. This also contributed to the decrease in effort expended viz. less number of fishing days for technology III. For technology IV that used bigger vessels, weather did not pose much risk and hence the effort was not significantly affected by this factor.

Fishing time was divided into soaking time, actual fishing time and total fishing time. Table 7.3 gives the figures for each sector. The fishing time progressively increased from technology I to IV. Comparison between technology I and II showed that, soaking time was almost same but the actual fishing time and total fishing time were more for technology II indicating that motorised sector spent more time at sea. Anon (1991) reported that there was no significant difference between non-motorised and motorised fishing units in time spent at sea. However, the present study indicated that along with technological level the time spent at sea also increased

Fishing effort expressed in man-hours is the product of time expended and crew size. The catch per man hour at sea was calculated taking into account the total trip time inclusive of fishing time and time taken to reach the fishing ground and return. The total fishing effort per trip was lowest for technology I and increased with the level of technology. The reason is that along with the technology level the area of operation also extended as evident from the depth of operation of each sector.

### **7.3.1.2. Productivity**

Standard index of productivity, the catch per unit effort, measured in terms of physical and value units was used to assess the comparative productivity of different technologies.

#### **7.3.1.2.1. Catch Per Unit Effort**

##### **Catch per Trip and per Fisherman**

The catch per trip was 11.58, 89.35, 54.41 and 302.09 kg for technology I, II, III and IV respectively (Fig. 7.3). The more than proportionate high value for technology IV was due to the multiday fishing practice. For technology I it was 91 kg in 1980-81 (Kurien and Willmann, 1982) and the present value showed a steep decrease

in productivity. Fig. 7.4 showed a decreasing productivity of this sector over the years. Technology II had a comparatively better catch per trip than technology III.

The catch /trip from technology IV in Cochin was 109.3 kg in 1981 and 93.2 kg in 1982 (Silas *et al.*, 1984). For the 1986-87 period Jayaprakash (1989) reported 124 kg. Compared to this the 1998-2000 value of 302.08 kg from the present study was due to the three day fishing trip as against the single day fishing practiced earlier. Per day catch value for 1998-2000 was worked out as 100.69 kg. This did not show a significant decline in catch over the years.

The catch per trip per fisherman ranged between 5.61 kg to 51.72 kg in different technologies. It was 5.61, 16.51, 13.56 and 51.72 kg for technologies I, II, III and IV respectively (Fig. 7. 5). The catch from technology IV was almost 10 times more than technology I. This high catch was due to multi-day fishing carried out by technology IV.

### **Catch Per Fishing Time**

Technology II demonstrated the highest catch per soaking time, catch per total fishing time and catch per man-hour (Fig. 7.6 to 7.9). The catch per man-hour was lowest for technology IV. This can

be explained by the fact that, due to the practice of multi-day fishing in technology IV the total trip time was high but the fishing operations were carried out during night only. The commuting time to distant grounds was also significant in this technology contributing to the total trip time.

According to Kurien and Willmann (1982), catch per man-hour in technology I in the year 1981 was 2.1 kg and in technology IV it was 1.9 kg. Our finding of 1.79 kg for technology I and 0.8 kg for technology IV indicates stagnancy in productivity in technology I, over the years. But the lower value in technology IV indicates that employment of bigger vessels, more powerful engines and operation in more distant and deeper waters did not result in higher productivity. The vessels used during 1980-81 were of 8-9 m LOA using engines of between 16 and 34 hp (Kurien and Willmann, 1982) while the present day vessels are between 9.1 and 13.6 m LOA fitted with engines of 60 and 90 hp.

### **Catch Per Area of Net Employed**

In gill nets, the area of net employed also contributes to productivity. Hence catch per unit effort was calculated on the basis



of area of net employed and corresponding number of fishing days following (Bergstrom, 1982). The calculation was done as below

$$\text{Total catch / Total effort} = \frac{\text{Weight (kg) of catch}}{\Sigma (\text{sq.m net} \times \text{fishing days})}$$

The results showed that technology II had higher catch per unit area of net than the other three technologies (Table 7. 4).

### **Catch Value Per Unit Effort**

Value of out put per trip, value of output per fisherman per trip and value of output per man-hour were the indices used to compare the productivity of different systems. Table 7.5 shows that value per trip and per fisherman were maximum for technology IV. This was due to the multi-day fishing in this case. Regarding catch value per man-hour, technology II had the highest advantage, followed by technology I and technology III, and lowest for technology IV. The overall results indicate the superior productivity advantages of motorised and mechanised sectors.

### **7.3.2. Economic Efficiency**

#### **7.3.2.1. Investment Profile**

Both the levels of technology and the scale of operation were largely reflected in (a) the absolute amount of investment and (b) its

profile. Table 7.6 presents the investment profile of the four technologies under consideration. The absolute amount of investment was positively correlated with the level of technology. The lowest investment was Rs. 31 375/- for technology I, while it was Rs.1 00 915/- for technology II, Rs.2 30 416/- for technology III and was Re. 6.75 lakhs for technology IV. Nearly 3 times the higher investment was required for technology II as compared to technology I. Technology III required nearly 7 times more investment than technology I. Technology IV required 21 times more investment than technology I.

Gear, craft and engine constituted three basic components of investment costs. The most crucial feature while combining these factors was that, there was absolutely no proportionality of investments between these basic components. This was very clearly brought out from the profile of investment of technology II, III and IV. In technology II, engine accounted for more than half of the investment cost, in technology III it was the gear that accounted for nearly half the investment and in technology IV it was the craft which accounted for nearly 60 % of the investment. It indicates that there existed no standard relation between the three components of investment viz. craft, gear and engine. Of the three technologies,

technology II, III and IV, the difference in investment between technology IV and the rest were phenomenal. Choice of investment in craft was almost completely decided by the locally familiar and geographically suitable design and investor's financial capability.

A major tendency in gill net fishing can be observed from the stress that was laid on investment on the gear. Technology I and III showed more investment on gear than on craft, while technology II had an investment almost close to the investment on craft. The stress on high investment on gear can be explained as follows.

Fishermen's response to intense competition in the open access fishery was reflected in the investment on craft, gear and engine but investment on gear had undergone rapid change as compared to investment in craft and engine. In gill net fishing, investment in gear can be increased in stages by frequent acquisition unlike in other gear, whereas engine and craft have to be acquired in one bulk investment. Consequently, the enhanced investment in a variety of gear or in more volume of gear by fishermen can be considered more as a competitive strategy of the fisherman.

### **7.3.2.2. Cost of Production**

#### **7.3.2.2.1. Variable Costs**

Variable cost or operational costs include day to day expenditure on fishing inputs such as fuel, labour, food, commission, ice and other miscellaneous costs. The cost of production under different technologies was brought out in Table. 7.7. Total variable cost as a percentage of investment worked out to be 178 % for technology I, 164 % for technology II, 43 % for technology III and 58.7 % for technology IV.

The variable cost and the investment ratio as given above indicated that the first two technologies were subjected to intensive utilization of capital investment by more than proportionate expenditure on variable cost, whereas the latter two technologies, which were more sophisticated, incurred nearly half of the investment as variable cost. In general, lower the relative ratio of variable cost to investment, less will be the efficiency of capital utilization. Both investment and variable cost complement each other, in reaching the efficiency level of output. A very high capital cost and very low variable cost lead to less efficient use of capital and consequently low efficiency in production.

## **Labour Costs**

The gross income is shared among the crew and the owner. The sharing pattern varied in different technologies. The share of crew was 66.66, 65, 65 and 33.33 % of the gross income in technology I, II, III and IV respectively. The crew share, unloading charges and bata of the crew were included under labour costs.

Labour accounted for the major input in fish harvest. Cost of labour as a ratio of total variable cost worked out to 74.1 % for technology I, 49.2% for technology II, 51.4% for technology III and 40.9 % for technology IV.

Technology I showed the highest labour intensity. This is due to the fact that, this technology is operated essentially on labour using it for both propulsion and harvest operations. Under technology II and III labour cost accounted for nearly half the variable cost. This may be explained by the difference in the share of total revenue going to labour.

## **Fuel Costs**

Fuel cost was the second important item of variable cost. It accounted for 32.9 % in technology II, 28.1 % in technology III and

29.6 % in technology IV of the total variable cost. Fuel cost as a percentage of total variable cost did not significantly differ between the technologies II to IV. It is noteworthy that technology II used more fuel both in terms of total amount spent and in terms of the percentage of total cost, though its total investment was less than half of the investment under technology III. Since both these technologies had identical investment on engine, the higher cost of fuel clearly established more intensive fishing operations by technology II.

On comparison of the fuel cost of technology II and technology IV, it was found that technology IV invested three times more on engine than technology II. But the percentage contribution of fuel cost to variable cost in technology IV was less (29.6 %) than in technology II (32.9 %). Part of this lower fuel cost was explained by the particular nature of the operations of the two technologies. Technology II made daily fishing trips, which involved a large share of fuel expenditure for commuting from the shore to the ground. This accounted for escalation of fuel cost whereas technology IV practised multi-day fishing, saving fuel consumption. A comparison of technology III and technology IV, which used the same gear, but different craft, showed that share of fuel cost to total variable cost was almost same in both.

## **Auction charges**

Five to ten percentages of the gross revenue were charged towards auction charges by the middlemen known as commission agents. In majority of the cases, the agents would have lent money to the fishermen for acquiring the assets on condition that the catch could be sold only through them. The commission or auction rate varied for different technologies viz., 6, 10, 5 and 6 % of the gross revenue for technology I, II, III and IV respectively. The auction charges formed 8.2, 12.6, 7.7 and 9.6 % of the total variable costs in technology I, II, III and IV respectively. If the fisherman is in a position to sell their produce directly, this expenditure could be avoided. Since the fisherman had no role in selling the catch often he was not getting the right price. The Matsyafed through the Fishermen Development Welfare Cooperative Societies has started conducting disposal of catch through auction in selected centres of the state. In these cases an amount of 5 % of the catch value only is charged towards auction charges.

## **Incidental costs**

The incidental costs included food allowances, transportation charges, berthing charges, cost of ice and other miscellaneous

expenses. This was 17.7, 5.2, 12.7 and 19.8 % of the total variable costs in technology I, II, III and IV respectively.

#### **7.3.2.2.2. Fixed costs**

Fixed costs viz. the items, which, in the short run could not be varied by the fishermen include depreciation, interest on capital and annual repair and maintenance costs.

Depreciation was worked out (Table 7.8) using the formula

$$\frac{(\text{Cost price} - \text{salvage value}) \times 100}{\text{Avg. life span} \times \text{cost price}}$$

The rate of interest on capital was taken as 10.5 % for fishermen's own capital and 15 % for capital borrowed from banks or government agencies such as Matsyafed. Fixed costs of the different gill net systems are given in Table 7.9.

The total cost followed the pattern of the cost of investment except for the higher total cost for technology II than for technology III (Table 7.10). This was explained by the fact that the variable cost under technology II was substantially higher than that under technology III. Total cost of fishing by technology II to IV gave an idea of financial burden of fishing operations. Annual cost of fishing worked out to be Re. 2 lakhs for technology II, Re.1.7 lakh for



technology III and Re. 5.78 lakh for technology IV. Technology IV was nearly 3 times costlier than the other two technologies.

### **7.3.2.3. Economic Performance**

Revenue from fishing, operational profit, net profit, rate of return and internal rate of return are given in table 7. 10. The four technologies under consideration had positive operational profit. The ratio of the average operational profit to the average gross revenue was 27.03 % for technology I, 20.93 % for technology II, 28.93 % for technology III and 37.61 % for technology IV.

While considering the net profit, of the four technologies, Technology III showed negative returns. Net profit for technology II and IV was barely significant. Technology III was operating at a net loss of Rs. 30 130/- per year. This does not however mean that the technology will be continuously under loss over the years. It was observed earlier that the technology III was under-utilized in comparison to technology II based on a comparison on the basis of fishing days and use of fuel. A little more intense use can wipe out their loss. Further, the technology III made an operational profit of over Rs. 40 592/- per year. This indicated that the labour was paid, the owners who are part of the crew got their wages. The positive

margin in the operation of technology III keeps the unit in the business. However, long run loss will force these units to go out of business. Because fishing units with positive operating profits but negative net profits are either undergoing temporary problem or simply living off their capital. Such situation can be met with either output enhancing or cost minimising efforts. This can be done by either starting two-day operation so that cost on fuel can be minimised or opting for diversification to line fishing also. However, two-day fishing required onboard facility for keeping iceboxes as well as provision for cooking and resting for the crew.

#### **7.3.2.3.1. Rate of Return and Investment Decision**

Rate of return, as a criterion for investment, cannot be over emphasized. It is a common measure used to find out the profitability of an economic activity. It is measured by the net profit generated per unit capital invested in the means of production. A non-participant investor or an absentee investor may use the criterion of rate of return for his investment decisions. But a fisherman whose family survives on total earnings from fishing may have limited use of the criteria of rate of return. Technology I yielded 15.23 % of return on investment whereas technology II & IV yielded respectively 8.84 and 8.38 % and technology III showed negative returns at 13.08 % (Table 7.10).

A fisherman whose family survived on the absolute earnings from fishing will compare the absolute earnings of the technology rather than the rate of return. The annual earning was Rs.56 565/- from technology IV, which was a reasonably good income, where as technology I provided only Rs. 4 778/- per year, which was hardly enough, for a family. From pure theoretical angle it can be argued that the entire investment of Re.6.75 lakhs could be invested on technology I to launch nearly 20 units of technology I and get 20 times the absolute income of Rs. 4 778/-. This will immediately lead to severe managerial problems that will affect the earning of the person. Hence, fishermen tend to invest in capital-intensive technologies with a view to increasing the carry home earnings rather than increasing the rate of return.

#### **7.3.2.3.2. Internal Rate of Return (IRR)**

For a consistent assessment of the economic performance of the technologies, the investment appraisal technique of IRR was worked out (Varshney and Maheshwari, 1981). It relates the face value of future cashflows to the present value by means of an imputed interest rate. There are two steps in this method in the first step, P - ratio is calculated by the formula

P ratio = Initial investment / annual cash flow

In step 2 the value of IRR viz. 'r' is determined by the formula

$$r = r_2 - \frac{v - v_2}{v_1 - v_2} \times (r_2 - r_1)$$

where v = rate of return to be determined by interpolation,

$r_1$  = lower rate of return

$r_2$  = higher rate of return

$v_1$  = the P ratio at the lower rate of return

$v_2$  = the P ratio at the higher rate of return

v = the P ratio for which r is to be interpolated.

Based on the above 2 steps, the IRR was worked out to 38.45 % for technology I, 9.50 % for technology II and 14.83 % for technology IV. IRR did not apply to technology III since the rate of return was negative. All the three technologies showed positive 'r' value showing that investment was as remunerative or more as saving in financial instruments.

The difference in the IRR of these technologies required certain clarifications. The high IRR accruing to technology I was largely due to the very low investment. Technology II had the lowest IRR since its life is only 5 years, which restricted the future cash

flows. Both technologies I and II had almost the same life span of 4 years but their investment differed by the ratio of 1:3. Hence the lower IRR for technology II. Technology IV and technology II had comparable annual rate of return of 8.38 and 8.84 respectively. But in terms of IRR, technology IV was superior with 14.83 % as against 9.50 % for technology II. The higher IRR of Technology IV was explained by larger cash flow coming from higher life span of 11 years for the technology.

#### **7.3.2.3.3. Sensitivity Analysis**

To evaluate the reliability of the IRR for different technologies, sensitivity analysis was carried out. This analysis was aimed at quantifying variations in IRR with reference to changes in basic cash flows affecting IRR. IRR will be adversely affected by the increase in the cost of investment due to increase in input prices or by decrease in the returns due to increase in variable cost, falling fish prices or by decrease in quantity of catch.

Sensitivity analysis worked out for adverse impact on investment and returns at five different levels of 5, 10, 15, 20 and 25 % is depicted in table 7. 11. All the three technologies can absorb 5 % adverse change either in investment or returns. Technology I and

IV can absorb adverse changes up to 25 %. However, technology II will be severely affected by adverse changes of more than 5 %.

#### **7.3.2.3.4. Pay Back Period**

Pay back period refers to number of years required to cover the investment cost by earnings from fish harvest. This is the ratio of investment to annual cash flow; the latter is the sum of net profit and depreciation. Table 7.12 showed that three technologies viz. Technology I, II and IV had a pay back period less than the life of the technology. This means that the technologies will continue to be operational after the investment cost is recovered. This is a very important pointer to the viability of the technologies.

In contrast, technology III will not cover the cost during its lifetime. If the negative returns persist, the technology will go out of operation after its lifetime leaving the investors in debt. It should be observed that the negative returns and the consequent extended period of pay back are due to the under utilization of the technologies as noted earlier. A concerted effort to optimise the pay back period can make it economically viable.

### 7.3.2.3.5. Factor Productivity

The rates of return as well as IRR are gross indices of economic performance of the technologies. These do not reveal productivity of factors such as labour and capital in fish harvesting. Table 7.13 shows different aspects of factor productivity such as output labour ratio, capital labour ratio, output capital ratio and labour capital ratio. Of these, output labour ratio points to the productivity of labour. The labour productivity was highest in technologies that had largest capital investment. Labour productivity was always higher, more the instruments of production at the disposal of labour. The capital labour ratio points out that technology was costlier per labour as sophistication and investment on technology were higher. The complimentarity of factors of production in enhancing the factor productivity is corroborated by output capital ratio. In technologies where capital was more productive labour was less productive and vice versa except in technology III. Nikita *et al.*, (2000) also reported that technology which showed higher capital productivity had lower labour productivity. Technology III exhibited least productivity of capital but not the highest labour productivity. This can be due to the less utilization of capital invested than the other three technologies as evident by the least number of days fished. Labour capital ratio

showed that labour requirement per capital decreased with increase in capital investment. This is due to the fact that gill-netting being a passive fishing method, the requirement of labour was limited and does not increase proportional to the increase in size of the gear.

#### **7.3.2.3.6. Fuel Efficiency**

With the introduction of motorisation, fuel has become an integral input in fishing operation. The fuel efficiency of different gill net systems under technology II, III and IV were compared using certain key indicators. Return to fuel is a very significant indicator of economic efficiency of fishing. Table 7.14 shows four different indicators of fuel efficiency. Of these, average revenue per rupee of fuel is the most important economic indicator. In terms of this indicator, technology IV was the most efficient. Factors behind this efficiency are noteworthy. Since Technology IV is a multi-day fishing operation, non-productive use of fuel in daily commuting is reduced. This accounted for higher fuel efficiency for Technology IV.

The average revenue per rupee of fuel for technology II and IV in 1989-90 were Rs. 8.60 and 9.95 respectively (Panikkar *et al.*, 1993). The present study showed a decrease in fuel efficiency. This



can be due to the increase in horsepower of the engine and the increase in fuel cost. The horsepower of the engine used in Technology II and IV in 1989-90 was 7 and 45-50 respectively (Panikkar *et al.*, 1993) as against 9.9 and 60-90 hp as per present study. Panikkar *et al.*, (1993) suggested that except ring seines no other motorised units of Kerala require engine having more than 7 hp.

A comparison of the energy yield of gill nets made with active fishing methods like ring seines and mini trawls showed that gill netting is more fuel-efficient. The revenue per rupee of fuel for ring seine during 1995-96 was Rs. 3.24 (Edwin, 1997) and for mini trawls during 1999-2000 was Rs.3.20 (Thomas and Hridayanathan, in press) as against 4.55, 5.03 and 6.08 in technologies II, III and IV in the present investigation.

#### **7.3.2.3.7. Fishery Income**

Ultimately the net income per fisherman is the index, which decides whether the technological sophistication helps in increasing the income of the fisherman. An important aspect of wages earned by fishermen is the absence of guaranteed minimum wages. Labour in most primary sectors such as agriculture receive obligatory wages for work done. Fishing labour is not paid a minimum guarantee wage.

Wages are paid in the form of a fixed percentage share of the catch value. When there is no catch, labour faces the same risk of no reward as the employer. Another aspect of fishing wages is that it is as seasonal as the fishery.

In spite of all these drawbacks, the annual income per fisherman from fishing alone is tolerably good. Table 7.15 shows the income per fisherman per trip, per hour and the annual income per fisherman in respect of the four technologies. Annual income of a fisherman of technology IV was maximum followed by technology I, technology II and technology III. Fishermen in technology I earned just above Rs. 20 000/- a year, as much as his counter part in technology IV whereas technology II and III provided around Rs.15 600 and 12 200 respectively. The relatively high annual income of non-motorised fishermen was due to the increased working days and lower fishing cost. Since there is no cash input in fishing they lose nothing if the catch is less. This resulted in increased fishing days whereas all the other technologies were season bound and they attempted to optimise fuel use.

Income per fisherman per trip increased from technology I to Technology IV while income per man-hour was compared, technology II ranked first with technology I closely following and

technology IV ranked the last (Fig. 7.10, 7.11). This inferred that in order to have one rupee of income, maximum effort (man-hour) was required for technology IV and the least for technology I (Table 7.16). The very high per trip wage under technology IV has to be viewed from the fact that the trip involved several days as opposed to the single day trips in the other three technologies.

On the whole the present study indicates that Technology III was least efficient (profitable) compared to other technologies though it was the third largest in terms of investment. Paradoxically the least sophisticated technology viz. technology I yielded maximum percentage returns. The most sophisticated technology viz. technology IV had comparable percentage of returns. In terms of IRR also technology I was impressive with 38.45 % as compared to 9.54 % by technology II and 14.83 % by technology IV.

The investment profile observed with reference to rate of return and IRR showed that technological sophistication or level of investments did not have direct effect on economic performance. This raises a question why do fishermen opt for high investment at lower rate of return. The answer is that the workers and operators are more concerned with absolute return than the rate of return. A 14.83 % return on a very large investment of Re.6.75 lakhs in technology IV

means much cash than 38.45 % on Rs. 31 375/- in technology I.  
Further technology III was operated even under a loss to meet the  
operational cost providing for survival.

**Table 7.1. Effort expended by different gill net systems**

Items	Tech. 1	Tech. 2	Tech. 3	Tech 4
Fishing days	241.88	95.00	66.13	183.5
Crew	2.04	5.23	4.2	5.94
Depth of fishing (m)				
Average	5.79	27.63	32.28	49.89
Range	1.6-11.2	20-39	16-59	27-200
Av. area of net used/trip (sq.m)	2242.31	6319.05	12795.83	19209.05

**Table 7.2. Distribution of non fishing days in different systems**

Reasons for not fishing	Tech.1	Tech. 2	Tech. 3	Tech. 4
Bad weather	64.54	11.98	40.27	0.00
Craft repair	2.15	0.00	0.65	0.00
Net repair	2.15	3.69	3.18	3.22
Engine repair	0.00	4.46	2.29	19.39
Lack of fish	23.38	74.8	53.52	70.95
Lack of crew	1.07	0.00	0.00	0.00
Personal	6.71	5.07	0.09	6.44
Total	100	100	100	100

\* Figures given are percentages

**Table 7.3 Fishing time per trip in different systems**

Type	Average crew size	Time per trip (h)			Total fishing effort (man-hours)
		Soaking time	Actual fishing time	Total fishing time	
Tech. 1	2.04	1.04	2.33	3.16	6.45
Tech. 2	5.23	1.01	3.40	5.91	30.91
Tech. 3	4.20	4.13	6.50	13.17	55.31
Tech. 4	5.94	20.07	54.54	64.76	384.67

**Table 7.4 Catch per area of net and fishing days**

Gill net system	Catch per '000 sq.m. net and fishing day (kg)
Technology1	5.17
Technology2	14.14
Technology3	4.25
Technology4	3.15

**Table 7.5. Catch value per unit effort**

Type	Value of output per trip			Value of annual output	
	Per unit (Rs)	Per trip per fisherman (Rs)	Per manhour (Rs)	Per unit (Rs)	Per fisherman (Rs)
Tech 1	316.48	155.13	49.07	76552	37525.5
Tech 2	2204.89	421.58	71.33	209465	40050.67
Tech 3	2121.41	505.09	38.35	140289	33402.1
Tech 4	10381.02	1747.65	26.99	635007	106903.5

**Table 7.6. Investment profile of different systems in 'Rs**

Type	Craft	Gear	Engine	Total
Technology 1	9375	22000	-	31375
	(31.02)	(68.98)	-	100
Technology 2	27000	22000	51915	100915
	(26.76)	(21.8)	(51.44)	100
Technology 3	65375	113123	51915	230416
	(28.37)	(49.09)	(22.54)	100
Technology 4	400000	125000	150000	675000
	(59.26)	(18.52)	(22.22)	100

**Table 7.7. Variable costs of different systems (in 'Rs)**

Items	Technolgy 1	Technolgy 2	Technolgy 3	Technolgy 4
Revenue	76552	209465	140289	635007
Variable cost				
Fuel	-	54550	28044	117323
Labour	41368	81477	51273	162094
Commission	4591	20946	7726	38100
Incidental cost	9899	8641	12654	78650
Total	55858	165614	99697	396167
Operational Profit	20694	43851	40592	238840

**Table 7.8 Depreciation for fixed assets**

Type	% depreciation		
	Craft	Gear	Engine
Technology 1	8.5	50	-
Technology 2	10	33.33	12.3
Technology 3	7.2	20	12.3
Technology 4	6	20	15



**Table 7. 9 Fixed Cost in different systems**

Items		Tech. 1	Tech. 2	Tech. 3	Tech. 4
Depreciation					
	Craft	797	2700	4707	24000
	Gear	11000	7333	22624	25000
	Engine	-	6386	6386	22500
	Total	11797	16419	33717	71500
Interest on capital		3294	12932	29916	70875
Repair & maintenance		825	5575	7089	39900
Total fixed cost		71774	200540	170419	578442

**Table 7. 10. Cost and earnings of different systems**

Items	Tech. 1	Tech. 2	Tech. 3	Tech. 4
Investment	31375	100915	230416	675000
Revenue	76552	209465	140289	635007
Total variable cost	55858	165614	99697	396167
Total Fixed Costs	5916	34926	70222	182275
Total cost	71774	200540	170419	578442
Net Profit	4778	8925	-30130	56565
Rate of return (%)	15.23	8.84	-13.08	8.38
IRR (%)	38.45	9.50	-	14.83

**Table 7.11. Sensitivity analysis on IRR in different systems**

Type	Average Investment (Rs)	IRR (%) for increasing investment cost by specified levels					
		Base value	5	10	15	20	25
Tech. 1	31375	38.45	37.55	36.73	35.97	35.27	34.64
Tech. 2	100915	9.50	7.56	6.88	6.34	5.85	5.39
Tech. 4	675000	14.83	14.19	13.83	13.40	12.98	12.62
Type	Net profit (Rs)	IRR (%) for decrease in returns by specified levels					
		Base value	5	10	15	20	25
Tech. 1	4778	38.45	37.50	36.56	35.68	34.63	33.67
Tech. 2	8925	9.50	7.44	6.76	6.07	5.39	4.71
Tech. 4	56565	14.83	14.29	13.74	13.17	12.62	12.05

**Table 7.12. Pay back period of different systems**

Type	Service life of the unit in years (weighted average)	Pay back period of capital in years
Technology 1	3.8	1.89
Technology 2	4.8	3.98
Technology 3	6.3	64.23
Technology 4	10.9	5.27

**Table 7.13 Factor Productivity of different systems**

Type	Capital investment (Re. Lakhs)	Labour units	Average revenue (Rs.)	Output - labour ratio	Output - Capital ratio	Capital -labour ratio	Labour -capital ratio
Tech. 1	0.31	2.04	316.48	155.13	2.43	0.15	6.58
Tech. 2	1.01	5.23	2204.89	421.58	2.07	0.19	6.17.
Tech. 3	2.30	4.2	2121.41	504.09	0.60	0.54	1.83
Tech. 4	6.75	5.94	3460.52	582.57	0.94	1.13	0.88

**Table 7.14. Indices of fuel efficiency of different systems**

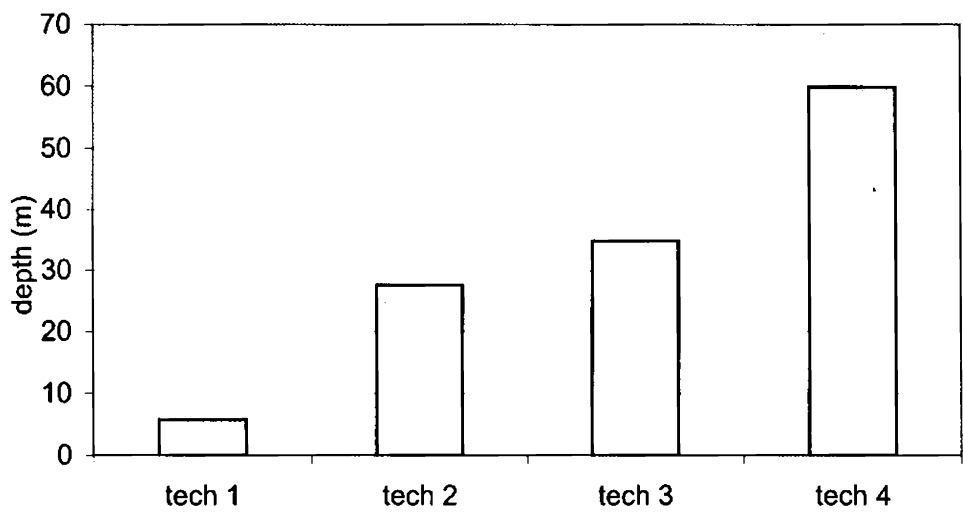
Indices	Tech. 2	Tech. 3	Tech. 4
Quantity of fuel required / trip (litre)	38.2	29.48	169.14
Cost of of fuel / trip (Rs)	543.91	440.85	1938.48
Quantity of fish produced/ litre of fuel (kg)	2.7	1.96	1.86
Quantity of fish produced / Re. of fuel (kg)	0.2	0.13	0.16
Revenue / litre of fuel (Rs.)	62.01	74.49	69.81
Revenue / Re. of fuel (Rs.)	4.55	5.02	6.08

**Table 7. 15. Income level of fisherman of different systems**

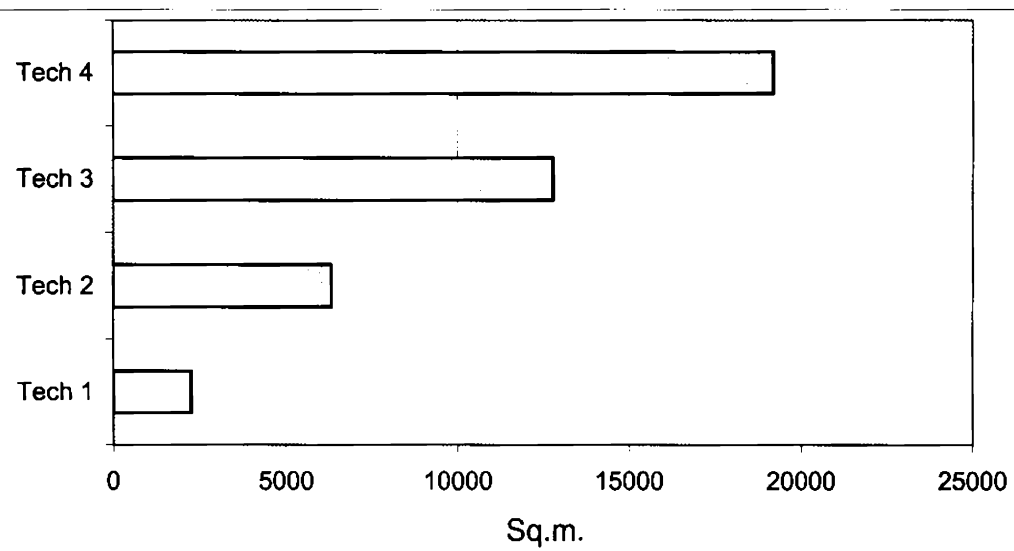
Type	Average income		Annual income per fisherman (Rs)
	per fisherman per trip (Rs.)	Per man hour (Rs.)	
Technology 1	83.84	26.51	20278.43
Technology 2	163.98	27.74	15578.77
Technology 3	184.60	14.02	12207.85
Technology 4	328.67	5.03	20101.35

**Table 7.16. Effort (Man-hours) per unit income in different systems**

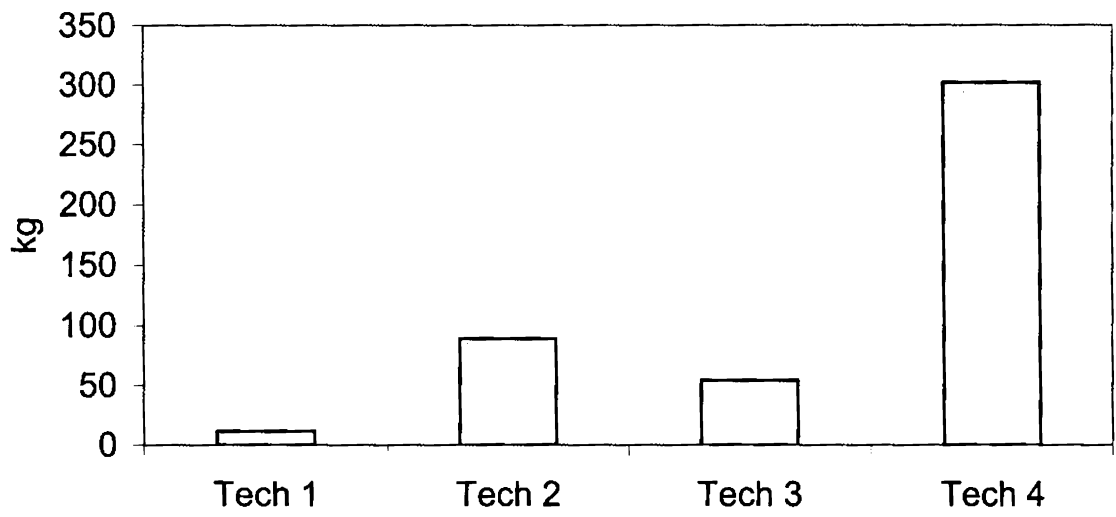
Technology	Man hours required to incur one rupee income
Technology 1	0.04
Technology 2	0.04
Technology 3	0.07
Technology 4	0.19



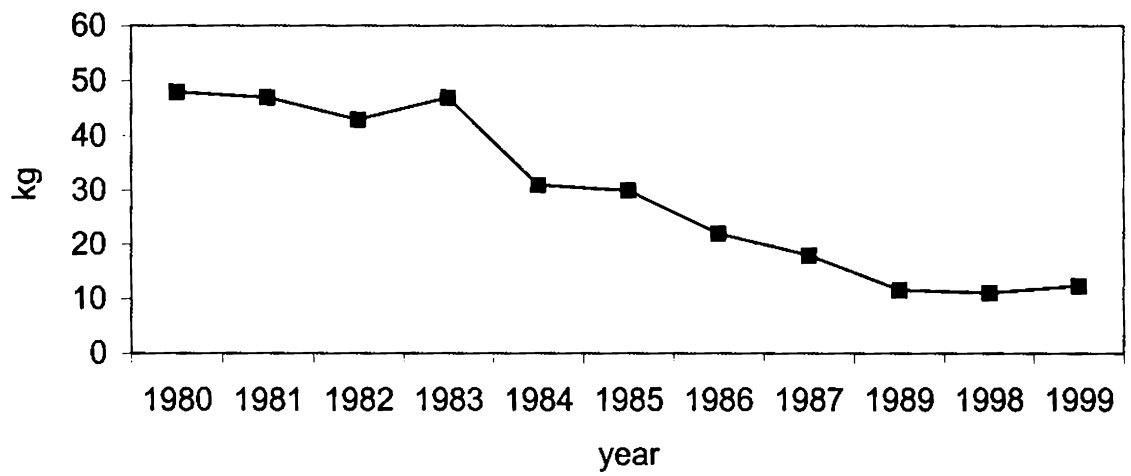
**Fig. 7.1. Average depth of fishing ground in different systems**



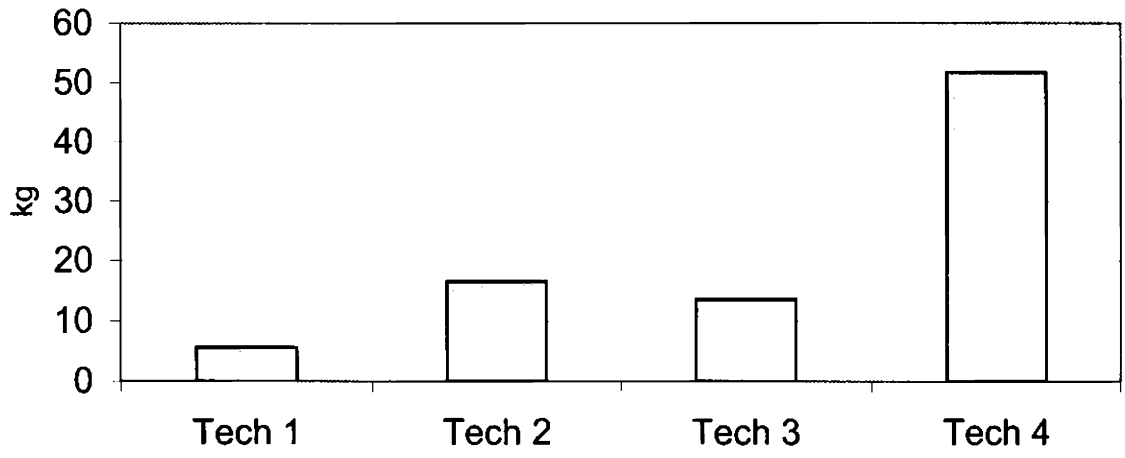
**Fig. 7. 2 Average volume of net used /trip in different systems**



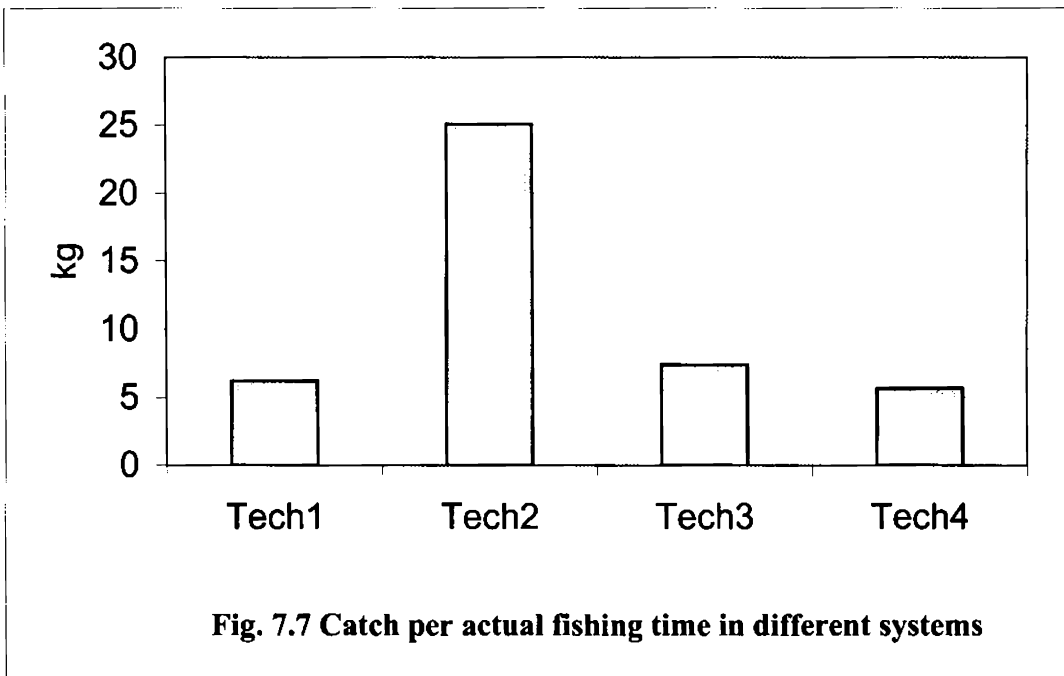
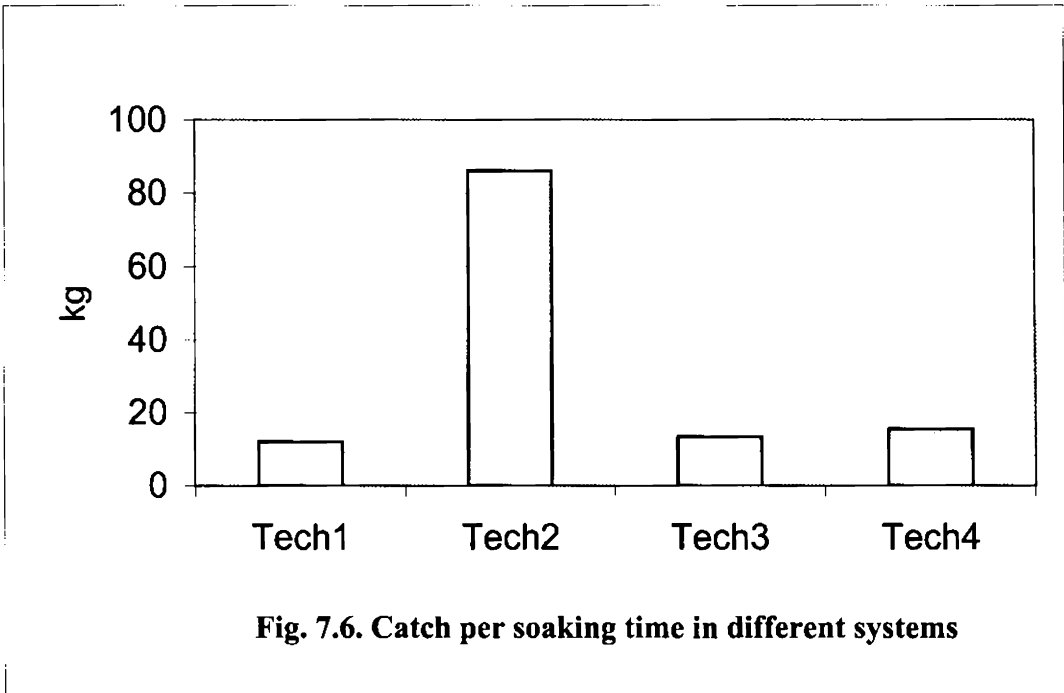
**Fig. 7.3. catch/trip in different gill net systems**



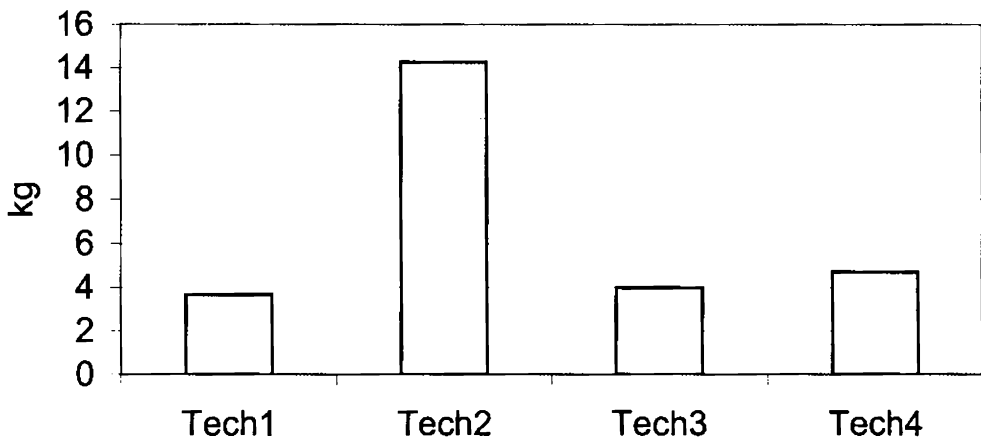
**Fig. 7.4. Catch per trip in technology 1 from 1980 to 1999**



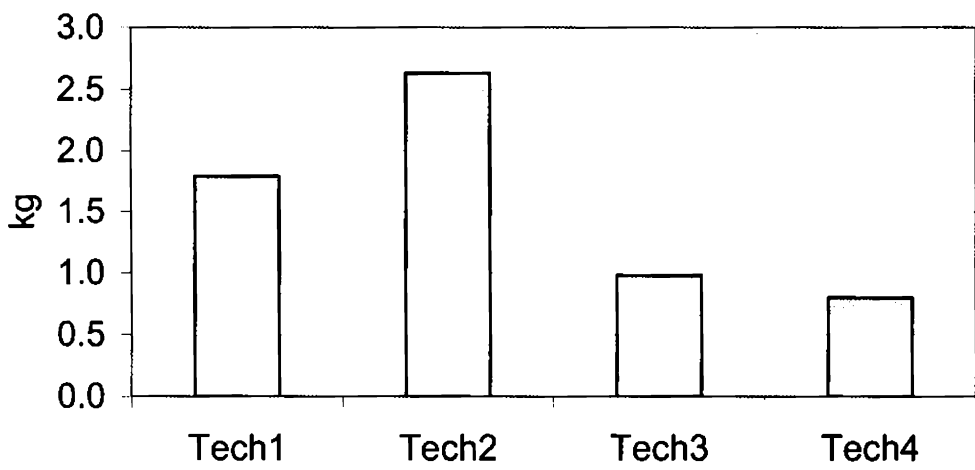
**Fig. 7.5. Catch per trip per fisherman in different systems**



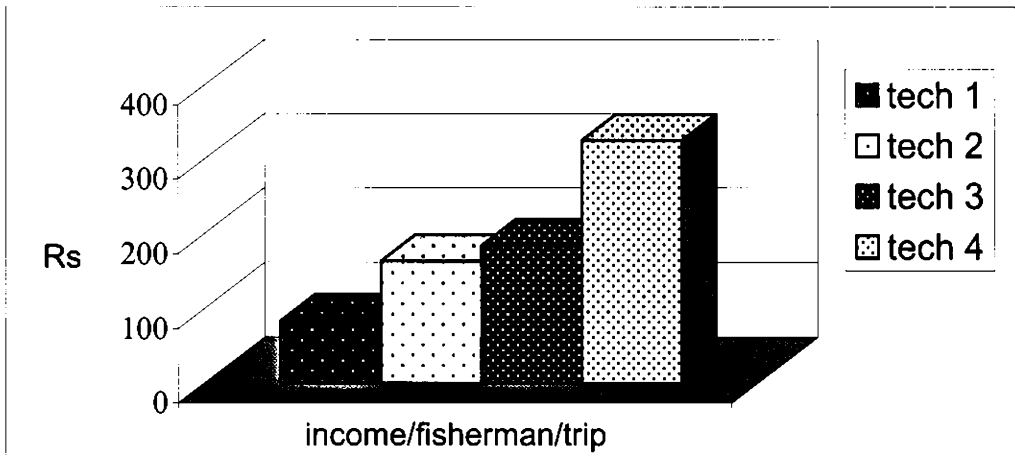




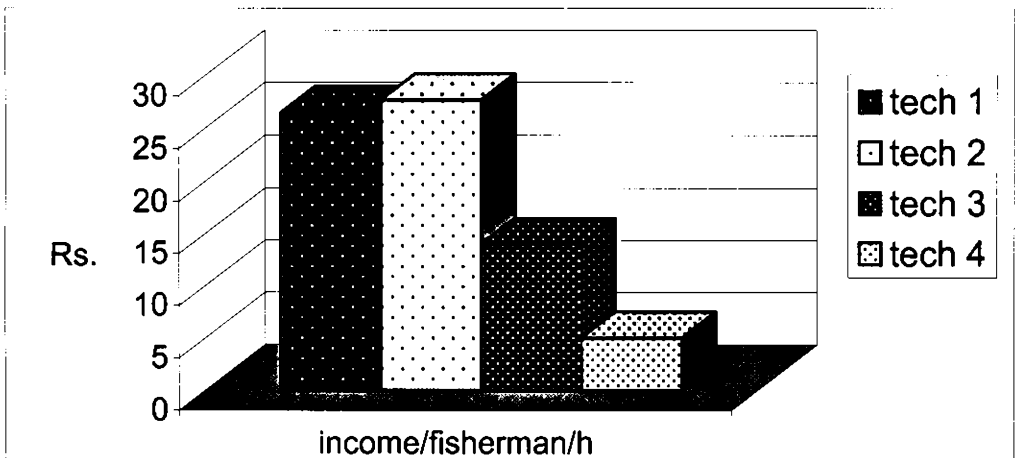
**Fig. 7.8 Catch per total fishing time in different systems**



**Fig. 7.9 Catch per man-hour in different systems**



**Fig. 7. 10. Income per fisherman per trip in different systems**



**Fig. 7.11 Income per man-hour in different systems**

## **Chapter 8**

# **Summary and Recommendations**

## Chapter 8

### SUMMARY AND RECOMMENDATIONS

#### 8.1. Summary

In most parts of the world, marine capture fisheries are reaching the limits of sustainability. This global phenomenon implies crossing the frontiers of production that natural stocks can sustain. Many fish stocks and fishing areas are fully exploited or overfished. Kerala also is no exception. Fishing effort in the state has exceeded both in quantitative and qualitative terms in such a way that even the artisanal fisheries sector has adopted smaller versions of non-selective and energy intensive fishing gears. Adoption of selective and low energy fishing methods seems to be an important alternative in meeting this crisis.

This study on gill nets of Kerala, the fishing method depended upon by maximum fishermen of the state focuses on the importance of this selective and low energy fishing method in the marine fishing sector of the state. The results of the study are detailed in eight chapters.

The study opens with the conceptual framework by briefly reviewing the crisis in the marine fisheries sector. Maximum

fishermen depend upon gill net, which is, an important selective and low energy fishing gear. A review of relevant literature on aspects such as material, selectivity and techno-economic efficiency together with scope and main objectives of the study form the major part of the compass of the introductory chapter.

The methodology of the study is detailed in the second chapter. Based on available secondary data, a baseline survey along the Kerala coast was conducted focusing on areas of intense gill net operation. This survey provided the inputs for selection of centres. The chapter presents the basis for selection of sample centres, sample units and methodology for field and experimental study.

Divided into two sections, the next chapter deals with the design and technical characteristics of the gill nets of Kerala coast. In the first section, the types of gill nets operated along the coast are identified; based on mesh size, method of operation and species targeted they are further classified into appropriate groups. Typical design of each net is given and the regional variations corresponding to the important technical specifications are discussed. Mention is also made on the changes that have taken place during the past four decades.

In the latter part of the chapter, design details of each type of net is scrutinised and evaluated. Such an exercise has been done with specific reference to twine size- mesh size ratio, buoyancy-weight relationship and hanging ratio. The analysis of the prevailing floatation-ballast relationship showed that, eventhough floatation and ballast are given arbitrarily by the fishermen based on experience, the theoretical ratios established by Fridman (1986) and Sainsbury (1996) are followed.

The subject matter of the fourth chapter is a basic study on gear materials. The weathering resistance, which is an important criterion to assess the material performance, was studied for polyamide monofilament in comparison to polyamide multifilament and polyethylene twisted monofilament. The property assessed by rate of loss in breaking strength and extension of materials exposed to sunlight is compared. The underlying degradation in the polymer leading to loss in strength assessed by infrared spectroscopy is also discussed. The study provides supporting evidence of oxidation and characteristic C-O stretching in polyethylene and cyclic lactam formation and presence of OH in polyamide.

The material for gill nets for large pelagics in Kerala continues to be polyamide multifilament while in many other states cheaper

polyethylene has been substituted. Chapter five summarises the results of the study conducted for substitution of polyamide of 210dx6x3 (Rtex 455) by polyethylene twisted monofilament of 1.25 mm diameter (Rtex 620) in seer gill nets. Polyethylene showed equal catching efficiency to polyamide while it costs only 52 % of the polyamide net.

The selectivity aspects of gill nets are covered in the sixth chapter under two sections. The former section covers the results relating to optimum selection length, selection factor and optimum mesh size for *Sardinella longiceps*, *Otolithes argenteus* and *Penaeus indicus*. The observed and estimated selection lengths are compared to assess the effect of the currently used mesh sizes on these species.

The small mesh gill net sector operating in the inshore waters of Kerala use gill nets consisting of a multitude of meshes. Results of the catch analysis of these nets for two successive years are given in the latter part of this chapter. The catch composition, size composition and proportion of juveniles caught in each mesh size are discussed. The study indicates that small mesh gill netting can be encouraged as a selective fishing method in the inshore waters with restrained use of 30 and 32 mm mesh sizes.

The next chapter discusses the technical and economic efficiency of gill net operations. Based on the level of technology and species targeted, four sub-sectors were identified within the gill net sector viz. non-motorised small mesh, motorised small mesh, motorised large mesh and mechanised large mesh sectors. The technical efficiency of these sub-sectors was compared with reference to fishing effort and productivity. Effort in terms of depth of fishing, days fished, fishing time and volume of net used show a direct relationship with the level of technology. Productivity in terms of physical (catch) and value (revenue) terms however, does not show such direct relationship. The economic efficiency was assessed using standard indices such as rate of return, internal rate of return, pay back period, fishery income, energy efficiency and factor productivity. The effect of size and cost of capital and cost of production on the economics of operation is also discussed in this chapter. It was observed that level of technology did not have direct effect on economic performance.

## **8.2. Recommendations**

Suggesting methods to manage the multispecies and multigear fisheries is not easy. For the marine fisheries of Kerala, which has a



long history of uncontrolled development, management is more difficult.

The present study on gill nets of the Kerala coast brings to light certain valid points which would make gill netting a more ecofriendly fishing method suitable for tropical fisheries. The following suggestions are given for further development and effective management of the gill net fishery.

- 1) The use of resource specific gill nets may be encouraged to suit specific resources available over space and time so that exploitation of juveniles can be minimised.
- 2) Polyethylene twisted monofilament can be used effectively to substitute polyamide multifilament in seer gill nets of Kerala. The study indicates that PE of 1.25 mm diameter is a good substitute for PA multifilament of 210dx6x3 currently used. The PE net has equal efficiency but costs only 52 % of the standard PA net.
- 3) The selectivity study categorically shows that the optimum mesh size for the exploitation is:
  - a) 34 mm for *Sardinella longiceps*;
  - b) 38 mm for *Otolithes argenteus*; and
  - c) 40 mm. for *Penaeus indicus*.

Mesh sizes stipulated above are found to exploit the resources in a safe way without affecting juveniles. Hence mesh sizes below these should be avoided to protect the resources.

- 4) The catch analysis of the small mesh gill nets shows that mesh size of 30 and 32 mm has to be used with utmost caution considering the multispecies nature of the inshore fishery.
- 5) As the spawning period of most of the fishes is during May to July gill netting using mesh sizes 30-38 mm during this period may be regulated.
- 6) Productivity of capital in a fishing unit depends on the effective utilization of it. Hence maximum utilization of capital by way of more fishing trips and more fishing time may be encouraged.
- 7) The importance of low energy nature of gill net fishing is to be highlighted in the light of its better fuel efficiency compared to other fishing methods.
- 8) The better performance of the mechanised large mesh sector engaged in multiday operations compared to single day operations of motorised large mesh sector give scope for motorised sector

also to engage in two day operations. The non-productive use of fuel in daily commuting can be reduced in multiday operations.

- 9) Finally, the fishermen should be made aware of the advantages and disadvantages of using different fishing gears. Through the involvement of actual fishermen only implementation of any regulation can be made successful. Hence they may be made aware of the need for sustainability of fish stocks and may be involved in the decision making.

## **References**

## REFERENCES

- Achari, T.T.R. 1993. Impact of Motorisation of Traditional Craft on Coastal Fishing and Fishermen Community – Kerala, In: *Development of Marine Fisheries for Higher Productivity*, Verghese, C. P. and Joy, P.S.(Eds.), CIFNET, India: 62-69
- Acosta, A.R. and Appledorn, R.S. 1995. Catching Efficiency and Selectivity of Gill Nets and Trammel Nets in Coral Reefs from Southwestern Puerto Rico, *Fish. Res.*, 22: 175-196
- Ahmed, M. 1999. Policy Issues Deriving from the Scope, Determinants of Growth and Changing Structure of Supply of Fish and Fishery Products in Developing Countries, In: *Fisheries Policy Research in Developing Countries: Issues, Priorities and Needs*, ICLARM conference proceedings, 60 (1): 37-57
- Alagaraja, K. 1984. Simple Methods for Estimation of Parameters for Assessing Exploited Fish Stocks, *Indian J. Fish.*, 31(2): 177-207
- Alagaraja, K., Scariah, K.S., Andrews, J., Vijayalakshmi, K. and Beena, M.R. 1994. *Recent Trends in Marine Fish Production in Kerala with Special Reference to Conservation and Management of Resources*, Kerala Fisheries Society, P.C.O Centre, Spencer Junction, Trivandrum, 43p.

- Alsayes, A., Awady, E. I. and Awady, N. 1996. Effects of (UV) Irradiation on Photochemical Degradation of Polyamide Mono and Multifilament Twines, *Bull. National Inst, Oceanogr. Fish. Egypt.*, 22: 29-41
- Amano, M. 1959. The Features and Use of Amilan Fishing Nets, In: *Modern Fishing Gear of the World, Vol 1.* Kristjonsson, H.(Ed.) Fishing News (Books) Ltd., London: 150-151
- Andreev, N.N. 1962. *Handbook of Fishing Gear and its Rigging*, Translated from Russian TT 66-5104. United States Department of Interior and Natural Science Foundation, Washington D.C, 504p.
- Annigeri, G.G. 1972. Fishery and Biology of the Oil Sardine at Karwar, *Indian J. Fish.*, 16: 35-49
- Anon, 1951. *Preliminary Guide to Indian Fish and Fisheries and Method of Fishing and Curing*, Marketing Series, No.66, Manager of Publications, New Delhi, 1-36
- Anon, 1961. North Pacific will be Full of Monofilament Next Year, *Pac. Fisherman.*, 59(1): 14
- Anon, 1979. Gill Net Fishing is Playing an Important Role in Promoting Coastal Fishing, *Yamaha Fishery Journal*, 6: 1-16
- Anon, 1981. All India Census of Marine Fishermen, Craft and Gear 1980, *Mar. Fish. Infor. Serv. T&E.Ser.*, 30: 2-32

- Anon, 1984. Small Scale Gillnet Fishery- A Practical Method for the Effectual Development of Coastal Fisheries, *Yamaha Fishery Journal*, 23: 193-195
- Anon, 1988. *Indian Agriculture in Brief*, Ministry of Agriculture, Govt. of India, New Delhi
- Anon, 1991. *Techno-Economic Analysis of Motorisation of Fishing Units- A Cost and Earning Study along the Lower South – West Coast of India*, PCO AND SIFFS, Trivandrum, 250p.
- Anon, 1992. *Supply and Demand in Fish nets in India: A projection upto 2000 AD*, A report on a study sponsored by Department of agriculture and Co-operation, Ministry of Agriculture, Govt. of India CIFT, Cochin-29, 88p.
- Anon, 1994. Gillnet Fishery in Japan, *Yamaha Fishery Journal*, 42: 6-7
- Anon, 1995. *Methodology Manual: Measurement of Fishing Gear Selectivity*, FAO (Personal Communication)
- Anon, 1996. *Marine Fisheries at A Glance- 1995: Kerala State*, Directorate of Fisheries, Trivandrum, 22p.
- Anon, 1997. Float Ropes Aid Gill Nets, *World Fishing*, 46(8): 23
- Anon, 1999. *Economic Review 1999*, State Planning Board, Trivandrum, 264p.

- Antony Raja, B.T. 1964. Some Aspects of Spawning Biology of Indian Oil Sardine *Sardinella longiceps* (Valenciennes). *Indian J. Fish.*, 11(1): 45-120
- Bal, D.V. and Banerji, S.K. 1951. A Survey of the Sea Fisheries in India, *Proc. Indo. Pac. Fish. Coun.* (Third Meeting), Sec. II: 176-181
- Bal, D.V and Rao, K.V. 1984. *Marine Fisheries*, Tata Mc Graw Hill Publishing Co. Ltd., New Delhi, 470p.
- Balan, K., Panikkar, K.K.P., Jacob, T., Andrews, J. and Rajendran, V. 1989. Motorisation of Country Craft in Kerala- An Impact Study, *CMFRI Sp. Publication No. 45*, Cochin, 74p.
- Baranov, F.I. 1914. The Capture of Fish by Gill Nets, (Partially transl. from Russian by W.E.Ricker) *Mater. Pozaniyu Russ. Rybolov.* 3(6): 56-59
- Baranov, F.I. 1933. *Commercial Fishing Technique*, Translated from Russian, Israel Programme for Scientific translations, Keter Publishing, Jerusalem, 254p.
- Baranov, F.I. 1948. Theory of Fishing With Gill Nets, In: *Theory and Assessment of Fishing Gear*, Translated from Russian by Out.Dep.Lands For., Maple. Out, 45p.
- Baranov, F.I. 1976. *Selected Works on Fishing Gear, Vol. 1, Commercial Fishing Techniques*, Translated from Russian,



Israel Programme for Scientific translations, Keter Publishing,  
Jerusalem, 631p.

Basu, S.P. 1975. Study of the biology of *Otolithes argenteus* (Cuvier) of  
Bombay, M.Sc. Thesis, Bombay University

Ben Yami, M. 1988. The Role of Small Scale Fishing Gear and  
Techniques in Devepment Challenges toward Year 2000, In:  
*Proceedings World Symposium on Fishing Gear and Fishing  
Vessel Design*, The Newfoundland and Labrador Institute of  
Fisheries and Marine Technology, P.O. Box 4920, St. John's,  
Newfoundland, Canada: 449-453

Ben Yami, M. 1989. *Mission to Kenya Lake Victoria Fisheries*, Report  
to the International Development Research Centre(IDRC),  
Nairobi, Kenya, Ottawa, Canada.

Ben Yami, M. 1993. Scope of Low Energy Fishing in the Present  
World Fisheries Context. In: *Low Energy Fishing, Fish.  
Technol.*, (Special Issue on Low Energy Fishing) Society of  
Fisheries Technologists, (India), Cochin: 120-124

Ben Yami, M.and Anderson, A.M. 1985. Community Fishery Centres:  
Guidelines for Establishment and Operations, *FAO Fish.  
Tech. Pap.* 264, 93p.

Bergstrom, M. 1982. *Pilot Survey of Driftnet Fisheries in Bangladesh*,  
BOBP/WP/15. BOBP, Madras, India, 16p.

- Bhusari, B.V. 1971. *Fishery and Biology of Four Important Sciaenids of Ratnagiri*, Ph.D. Thesis, Bombay University
- Bjoringsoy, L. 1996. Gill Netting- the Selective Fishing Method, *Infofish International*, 4: 67-70
- Blady, W., Borowski, W. and Zancha, J. 1994. Selectivity of Pike Perch Gillnets used in the Vistula Lagoon, *Bull. Sea Fish. Inst.*, 3: 9-17
- Brandt, A.V. 1959. Fishing Gear and its Operation, In: *Modern fishing gear of the world Vol.1*, Kristjonsson, H. (Ed), Fishing News (Books) Ltd, London: 133-135
- Brandt, A.V. 1984. Gill Netting, In: *Fish Catching Methods of The World* (3<sup>rd</sup> edn.) Fishing News Books Ltd., London: 355-367
- Burd, A.C. 1963. On Selection by Drifter Fleets in the East Anglian Herring Fishery, *J. Cons. Cons. Int. Explor. Mer.*, 28: 91-120
- Burdon, T.W. 1952. Consideration of the Classification of Fishing Gear and Methods, *Indo- Pacific Fisheries Council*, 3, Meet. 2. Sect., 143-165
- Carrothers, P.J.G. 1957. *The Selection and Care of Nylon Gill Nets for Salmon*, Fisheries Research Board of Canada. Ind, Mem. 19, 85p.
- Carter, C.L.B. and West, K. 1964. Use of Ulstron Polypropylene in Fishing, In: *Modern Fishing Gear of the World Vol. 2*,

Kristjonsson, H.(Ed.) Fishing News Books Ltd., London: 57-60

Cecily, P.J. and Radhalakshmi, K. 1985. Synthetic Fibres in Indian Fishing Industry, In: *Harvest and Post-harvest Technology of Fish*. Ravindran, K., Unnikrishnan Nair, N., Perigreen, P.A., Madhavan, P., Gopalakrishna Pillai, A.G., Panicker, P.A. and Mary Thomas (Eds.) Society of Fisheries Technologists (India), Cochin: 284-288

Chernphol, S. 1951. Indigenous Marine Fishing Gear of Thailand, *Proc. Indo- Pacific Fish. Coun.*2(2/3): 98-123

Chidambaram, K. and Venkataraman, R.S. 1946. *Tabular Statements on the Fishery of Certain Food Fishes of the Madras Presidency-West Coast*, Govt. Press, Madras: 1-26

Clark, J. R. 1960. Report on Selectivity of Fishing Gear, ICNAF. Sp. Publ., 2: 27-36

Collins, J.J. 1979. Relative Efficiency of Multifilament and Monofilament Nylon Gill Net towards Lake White Fish (*Coregonus clupeaformis*) in Lake Hurm, *J. Fish. Res. Board Can.*, 36: 1180-1185

Collins, J.W. 1882. Gill Nets in the Cod Fishery: A Description of the Norwegian Cod Nets with Directions for Their Use, and A

History of their Introduction into the United States. *Bull. U. S. Fish. Comm.* 1: 1-17

Daruvwalla, E. H. 1967. Photodegradation of Cotton and Chemically Modified Cotton Part1- Behaviour During Exposure to Carbon Arc and Solar Radiation, *Textile Res. J.*, 37: 147-172

Davis, F.M. 1927. An Account of the Fishing Gear of England and Wales-Ministry of Agriculture and Fisheries, Fishery investigations, Series 11, Sea Fisheries, 9(6)

Davis, F.M. 1958. *An Account of Fishing Gear of England and Wales*, Fishery Investigation (Min. Agri. Fish and Food), Series II, 21(8): 156p.

Dayaratne, P. 1988. Gill Net Selectivity for *Amblygaster (Sardinella ) sirm.* *Asian Fish. Sci.*, 2: 71-82

Devaraj, M. 1977. *The Biology of and Fishery for the Seer Fishes in India*, Ph.D.Thesis, Madurai Kamaraj University, Madras.

Devaraj, M. and Smitha, P. 1988. Economic Performance of Mechanised Trawlers in the State of Kerala, India, *Fish. Res.*, 6: 271-286

Dhulkhed , M.H. 1976. Observations on the Spawning Behaviour of the Indian Oil Sardine *Sardinella longiceps* (Valenciennes) Determined by Ova Diameter Studies, *Indian J. Fish.*, 11A(1): 371-376

- Dupont, 1967. *Light and Weather Resistance of Fibres*, Tech Services Bull, Text. Fibres Dept., X-45, Dupont of Canada Ltd., Kingston, Ontario
- Dutta, K.K. and Dan, S.S. 1992. Economics of Gill Net Fishing in West Bengal, *Sea Food Export J.*, 5: 14-19
- Ede., D.F.C and Henstead, W. 1964. Monofilament in Fishing, In: *Modern fishing gear of the world*, 2. Kristjonsson, H. (Ed), Fishing News (Books) Ltd, London: 66-68
- Edwin, L. 1997. *Studies on the Ring Seine Fisheries of South Kerala Coast*, Ph.D. Thesis, Cochin University of Science and Technology, Cochin, 189p.
- Egerton, G.S. and Shah, K.M. 1968. The Effect of Temperature on the Photochemical Degradation of Textile materials. Part I, Degradation Sensitization by Titanium Dioxide, *Textile Res. J.*, 38: 130 – 135
- Endal, A. 1979. Fuel Saving. *Fish News Int.* 19 (10): 16-17
- Erzini, K. and Castro, M. 1998. An Alternative Methodology for Fitting Selectivity Curves to Predefined Distributions, *Fish. Res.*, 34: 307-313
- FAO, 1978. *FAO Catalogue of Fishing Gear Designs*. Farnham, Surrey, Fishing News Books for FAO, 159 p.

- FAO, 1995. *Code of Conduct for Responsible Fisheries*, FAO, Rome, 41p.
- FAO, 2000. *FAO Yearbook, Fishery statistics- Capture Production*, Vol. 86/1, 1998, FAO, Rome, 713p.
- Firth, P.E. 1950. Nylon Gill Netting Proves Successful, *Atlantic Fishermen* 31(10): 16-20
- Fischer, W. and Bianchi, G. 1984. *FAO Species Identification Sheets for Fishery Purposes Western Indian Ocean (Fishing Area 51)*, FAO, Rome.
- Fitzpatrick, J. 1989. Fishing Technology, Fisheries Resources and Future Demand, In: *Proceedings of World Symposium on Fishing Gear and Fishing Vessel Design*, The Newfoundland and Labrador Institute of Fisheries and Marine Technology, P.O. Box 4920, St. John's, Newfoundland, Canada: 1-8
- Fredericks, L.J. and Nair, S. 1985. Production Technology of Small - Scale Fisheries in Peninsular Malasia, In: *Small-Scale Fisheries in Asia: Socioeconomic Analysis and Policy* (Panayotou, T. (Ed.), International Development Research Centre, Ottawa, Ont., 164-176
- Fridman, A.L. 1973. *Theory and Practice of Commercial Fishing Gear*, Israel Programme for Scientific Translations Ltd., Jerusalem, 489p.

- Fridman, A.L. 1986. *Calculations of Fishing Gear Designs*, FAO Fishing Manual, Fishing News Books (Ltd), Farnham, 264p.
- George, V.C. 1971. An Account of the Inland Fishing Gear and Methods of India, *CIFT Sp. Bull.*, 1, 37p.
- George, V.C. 1981. Indigenous Marine Fishing Gear and Methods of India, Part 1. Karnataka State, *CIFT Sp. Bull.*, 9, 20p.
- George V.C. 1991. *Studies on Prawn Gillnet of the Kerala coast*, Ph.D.Thesis, Cochin University of Science and Technology, Cochin, 189p.
- George, V.C. (in press). Low Energy Fishing Techniques for Sustainable Fisheries Development, presented in the *National symposium on 'Sustainable Development of Fisheries Towards 2000 AD-Opportunities and Challenges*, held at Cochin during 21-23 April 1999.
- George, V.C. and Brandt, A.V. 1975. Gill Nets. In: *FAO Catalogue of Small Scale Fishing Gear*, Nedelec, C. (Ed.), Fishing News Books Ltd., England: 126p.
- George, M.J., Suseelan, C., Thomas, M.M. and Kurup, N.S. 1980. Shrimp Resources along Neendakara Coast Kerala, *Mar. Fish. Infor. Serv. T&E Ser.*, 18: 1-8
- Gnatowski, M. 1993. Plastic Identification, In: *Plastic Waste Management: Disposal, Recycling and Reuse*, Environmental

Science and Pollution Control Series, Marcel Dekker Inc.,  
Newyork: 91-118

Gulbrandsen, O. 1984. *Fishing Craft Development in Kerala: Evaluation Report*, BOBP/WP/25. BOBP, Madras, India, 20p.

Gulbrandsen, O. 1986. *Reducing Fuel Costs in Small Scale Fishing Boats*, BOBP/WP/27, Bay of Bengal Programme, Madras, 18p.

Gulland, J.A., and Harding, D. 1961. The Selection of *Clarias mossambicus* (Peters) by Nylon Gill Nets. *J. Cons. Cons. Int. Explor. Mor.* 26: 215-222

Hameed, M.S. and Boopendranath, M.R. 2000. *Modern Fishing Gear Technology*, Daya publishing House, Delhi, 186p.

Hamley, J. M. 1975. Review of Gill Net Selectivity, *J. Fish. Res. Board Can.*, 32(11): 1943-1969

Hamley, J.M. and Regier, H.A. 1973. Direct Estimates of Gill Net Selectivity to Walleye (*Stizostedion vitreum vitreum*). *J. Fish. Res. Board Can.*, 30: 817-830

Havinga, B. and Deedler, C.L. 1949. The Relation between the Size of Meshes of Gill Nets and The Size of *Luciperca sandra* in the Catches, *Rapp.P. – V. Reun. Con . Int. Explor. Mer.*, 125: 59-62



- Holt, S. J. 1963. A Method of Determining Gear Selectivity and its Application, *ICNAF Spec. Publ.*,5: 106-115
- Honda, K. and Osada, S. 1964. Polypropylene Twines in Japan, In: *Modern Fishing Gear of the World, Vol. 2*, Kristjonsson, H. (Ed.), Fishing News (Books) Ltd., London: 55-57
- Hornell, J. 1938. The Fishing Methods of Madras Presidency. Part I. The Malabar Coast, *Madras Fisheries Bulletin*. 27(1): 1-69
- Hornell, J. and M.R.Nayudu, 1924. A Contribution to the Life History of the Indian Oil Sardine with A Note on the Plankton of the Malabar Coast, *Madras Fish. Bull.*, 17: 129-97
- IS: 4401 (1976) *Indian standard Specifications for Nylon Fish Net Twines*, ISI, Manak Bhavan, New Delhi, 6p.
- IS: 5815 (1971) *Indian standard Specifications: Methods of Tests for Fishing Gear Materials, Part IV, Determination of Breaking Load and Knot Breaking Load*, ISI, Manak Bhavan, New Delhi, 7p.
- IS: 6347 (1971) *IS Specifications for Polyethylene Monofilament Twines for Fishing*, ISI, Manak Bhavan, New Delhi, 5p.
- Indurfurth, K.H. 1953. *Nylon Technology*, McGraw Hill Book Co. Inc., Newyork.

- IPTP, 1990. *Report of the Expert Consultation on Stock Assessment in the Indian Ocean*, Bangkok, 2-6, July 1990.
- Ishida, T. 1962. On the Gill Net Mesh Selectivity Curve, *Bull. Hokkaido Reg. Res. Lab.*, 27: 7-12
- Ishida, T. 1964. Gill Net Selectivity Curves for Sardine and Herring, *Bull. Hokkaido Reg. Res. Lab.*, (Transl. From Japanese by *Fish. Res. Board Can. Transl. Ser. No. 1284*: 28: 56-60
- Ishida, T. 1969. The Salmon Gill Net Selectivity Curve, *Int. North Pac. Fish. Comm. Bull.*, 26: 1-11
- Iyer, H. K. 1993. Economics of Operation of Fishing Vessels for Low Energy Fishing, In: *Low Energy Fishing, Fish. Technol.*, (Special Issue on Low Energy Fishing) Society of Fisheries Technologists, (India), Cochin: 262-264
- Iyer, H.K., Unnithan, G.R., Srinivasa Rao, P., Nair, A.K.K. and Nair, R.G. 1985. Economics of Operation of Fishing Vessels (Trawlers), In: *Harvest and Post-harvest Technology of Fish.* Ravindran, K., Unnikrishnan Nair, N., Perigreen, P.A., Madhavan, P., Gopalakrishna Pillai, A.G., Panicker, P.A. and Mary Thomas (Eds.) Society of Fisheries Technologists (India), Cochin: 721-723
- Jayantha, S.P.M. and Amarasinghe, O. 1998. Efficiency of Production Technology in Marine Fisheries: The Case of Gill Net

Fisheries in Southern Sri Lanka, In: *Technological Advancements in Fisheries*, Hameed., M.S. and Kurup, B.M. (Eds.), School of Industrial Fisheries, Cochin University of Science and Technology, Cochin: 208-215

Jayaprakash, A.A. 1989. Trends in Drift Gill Net Fishery off Cochin with Special Reference to Effort, Inputs and Returns During 1981-82 and 1986-87, In: *Studies on Fish Stock Assessment in Indian Waters*, Papers presented by the participants at the FAO/ DANIDA/FSI training course cum workshop on fish stock assessment, 14 Nov-14 Dec, Aug. 1989: 87-105

Jensen, J.W. 1986. Gill net selectivity and the efficiency of alternative combination of mesh sizes for some fresh water fish, *J. Fish. Biol.*, 28: 637-646

JICA, 1981. *Fishing Techniques*, Japan International Cooperation Agency, Tokyo, 183p.

John, A.T. 1996. *Energy Optimization Studies in Trawling Operation along Kerala Coast*, Ph.D.Thesis. Cochin University of Science and Technology, Cochin, 213 p.

Johnstone, A.D.F. and Mackie, A.M. 1986. *Scottish Fisheries Bulletin*, 49: 7

- Jones, R. 1984. Assessing the effects of changes in exploitation pattern using length composition data (with notes on VPA and cohort analysis), *FAO Fish. Tech. Pap. No.*, 256, 118p.
- Joseph, K.M and Sebastian, A.V. 1964. The Effect of Mesh Size on the Fishing Efficiency of Sardine Gill Nets, *Fish. Technol.*, 1(2): 180-82
- Kagwade, P.V. 1970. The Polynemid Fishes of India, *Bull.Cent. Mar. Fish. Res. Inst.*, No. 18: 69p.
- Kalawar, A.G., Devaraj, M., Arun,H. and Parulekar.1985. *Report of The Expert Committee on Marine Fisheries in Kerala*, 467p.
- Karlsen, L. 1989. Influence of the Materials on the Performance of Fishing Gears, In: *Proceedings World Symposium on Fishing Gear and Fishing Vessel Design*, The Newfoundland and Labrador Institute of Fisheries and Marine Technology, P.O.Box 4920, St. John's, Newfoundland, Canada: 255-258
- Karlsen, L. and Bjarnasson, B.A. 1987. Small Scale Fishing with Drift Nets, *FAO Fish. Tech. Pap.*, 284, 64p.
- Kartha, K.N. and Rao, K.S. 1991. Selectivity of gill nets for *Catla catla* (Ham) *Cirrhinus mrigala* (Day) and *Labeo rohita* (Ham) in Gandhi Sagar reservoir, *Fish. Technol.*, 28(1): 5-10
- Karunasinghe, W.P.N. and Wijayaratne, M.J.S.1991. Selectivity Estimates for *Amblygaster sirm* (Clupeidae) in the Small-

- Meshed Gill Net Fishery on the West Coast of Sri Lanka,  
*Fish. Res.*, 10: 199-205
- Kemparaju, S. 1994. Drift gill net fishery of Goa, *Mar. Fish. Infor. Serv. T & E Ser.*, 128: 5-8
- Khaled, M.S. 1985. Production Technology of Small Scale Fisheries in Bangladesh, In: *Small Scale Fisheries in Asia: Socio-economic Analysis and Policy*, Panayotou, T. (Ed.), International Development Research Centre, Ottawa: 102-113
- Khan, A.A., George, N.A. and Pandey, O.P. 1975. On the fishing power of monofilament and multifilament gillnets, *Fish. Technol.*, 12(1): 64-66
- Khan, A.A., George, N.A., Mathai, T.J. and Nair, A.K.K. 1989. On the Optimum Mesh Size for the Capture of *Barbus tor* (Hamilton), *Fish. Technol.*, 26: 92-94
- Khan, A.A., Dawson, P. and Kartha, K.N. 1993. Relative catch efficiency of newer fishing gear materials, In: *Low Energy Fishing, Fish. Technol.*, (Special Issue on Low Energy Fishing) Society of Fisheries Technologists (India), Cochin: 116-118
- Kitahara, T. 1971. On Selectivity Curve of Gillnet. *Bull. Jap. Soc. Sci. Fish.*, 37: 289-297

- Klust, G. 1959. Relative Efficiency of Synthetic Fibres in Fishing, Especially in Germany, In: *Modern Fishing Gear of the World, Vol.1* Kristjonsson, H. (Ed.), Fishing News (Books) Ltd., London: 139-146
- Klust, G. 1964. *Modern Fishing Gear of the World. Vol.2.* Fishing News (Books) Ltd., London, 50p.
- Klust,G. 1973. *Netting Materials for Fishing Gear.* Fishing News (Books) Ltd., England, 173p.
- Klust, G. 1982. *Netting Materials for Fishing Gear,* FAO Fishing Manual, Fishing News Books (Ltd)., Farnham, 192p.
- Koya, K.P. and Vivekanandan. 1992. Gill Net Fishery off Veraval During 1982-1990, *Mar.Fish.Infor.Serv.T&E Ser., 116:* 1-4
- Kurien, C.V. and Sebastian, V.D. 1976. *Prawns and Prawn Fishing of India,* Hindustan Publishing Corporation Printing Press, Delhi, India, 280 p.
- Kurien, J. and Willmann, R. 1982. *Economics of Artisanal and Mechanised Fisheries in Kerala. A study on Costs and Earnings of Fishing Units,* Working paper No. 34, FAO-UNDP, Madras, India: 114p
- Kurup, K.N. and Devaraj, M. 2000. Estimate of Optimum Fleet Size for The Exploitation of Indian Shelf Fisheries, *Mar.Fish. Infor. Serv. T&E Ser., 165:* 2-11.

- Librero, A.R., Ramos, D. and Lazpie, L. 1985. Mechanisation: its Impact on Productivity, Cost Structure and Profitability of the Philippine Municipal Fishery, In: *Small Scale Fisheries in Asia: Socio- economic Analysis and Policy*, Panayotou, T. (Ed.) Ottawa, Ont, IDRC: 151-162
- Little, A.H. and Parsons, H.L. 1967. The Weatherability of Cotton, Nylon and Terylene Fabrics in the U.K, *J. Textile Inst.*, 58: 449 - 462
- Luther, G. and Appanna S. Y. 1993. Occurrence of Spawners, Juveniles and Young Fish in Relation to the Fishing Seasons of Some Major Fishery Resources of India, A Preliminary Study. *Mar.Fish. Infor. Serv. T&E Ser.*, 122: 1-8
- Luther, G., Sessa Giri Rao, C.V. and Sumithrudu, M.S. 1994. The Role of Gill Nets in the Exploitation of Lesser Sardines, *Mar.Fish. Inf. Serv. T&E. Ser.*, 128: 10-14
- Luther, G., Pillai, P.P., Jayaprakash, A.A., Gopakumar, G., Satianandan, T.V., Molly, V., Sathiadas, R. and Sivsakami, S. 1997. Gill Net Fisheries of India, *Mar. Fish. Infor. Serv. T &E Ser.*, 150: 1-23
- Lzarkins, H.A. 1963. Comparison of Salmon Catches in Monofilament and Multifilament Gill Nets, *Commer. Fish. Rev.*, 25(5): 1-11

- Madsen, N., Holst, R., Wileman, D. and Poulsen, T.M. 1999. Size Selectivity of Sole Gill Nets Fished in the North Sea, *Fish. Res.*, 44(1): 59-74
- Mathai, T.J. and George, N.A. 1972. A Note on the Comparative Catch Efficiency of Nylon over Cotton Gill Nets in Reservoir Fishing, *Fish. Technol.*, 9(1): 81-82
- Mathai, T.J., George, T.P., Sadanandan, K.A., George, N.A. and Nair, A.K.K. 1990. Studies on Prawn Fishing by Gill Netting, *Fishing Chimes*, 10(9): 36-38
- Mathai, J., Vijayan, V., Abbas, M.S., Manohar Doss, R.S. and Iyer, H.K. 1993. Mesh Selectivity Studies on Mackerel Gill Net, In: *Low Energy Fishing, Fish. Technol.*, (Special Issue on Low Energy Fishing) Society of Fisheries Technologists, India, Cochin: 183-190
- Mattson, N.S. 1994. Direct Estimates of Multi-Mesh Gill Net Selectivity to *Oreochromis shiranus* Chilwae, *J. Fish. Biol.*, 45(6): 997-1012
- Matuda, K. 1988. Headline Height of Bottom Gill Nets Set Across a Water Flow. *Fish. Res.*, 6: 167-179
- Matuda, K., and N. Sannomiya. 1977a. Theory and Design of Bottom Drift Net –I. A Method of Numerical Analysis on the Motion of Gear. *Bull. Jap. Soc. Fish.* 43(6) :669-678



- Matuda, K., and N. Sannomiya. 1978. Theory and Design of Bottom Drift Net –III. Analytical Solution of Equation of Motion of Gear. *Bull. Jap. Soc. Fish.* 44(1) :7-13
- Mc Combie, A.M. 1961. Gill Net Selectivity of Lake White Fish from Goderich-Bayfield Area, Lake Huron, *Trans. Am. Fish. Soc.*, 90: 337-340
- Mc Combie and Fry, F.E.J. 1960. Selectivity of Gill Net for Lake Whitefish, *Coregonus clupeaformis*, *Trans. Am. Fish. Soc.*, 89: 176-184
- Mc Combie and Berst, A.H. 1969. Some Effects of Shape and Structure of Fish on Selectivity of Gill Nets, *J. Fish. Res. Board Can.*, 26: 2681-2689
- Meenakumari, B. and Ravindran, K. 1985. Tensile Strength Properties of Polyethylene Netting Twines under Exposure to Out-Door and Artificial UV Radiation, *Fish. Technol.*, 22: 83-86
- Meenakumari, B. and Radhalakshmi, K. 1988. Induced Photoxidative Degradation of Nylon 6 Fishing Net Twines, *Indian J. Text. Res.*, 13: 84-86
- Meenakumari, B., Ravindran, K. and Kesavan Nair, A.K. 1985. Effect of Sunlight and UV Radiation on Mechanical Strength Properties of Nylon Netting Twines, *Indian J. Text. Res.*, 10: 15-19

- Meenakumari, B., Radhalakshmi, K. and Panicker, P.A. 1993. Netting Materials for Low Energy Fishing Gear, In: *Low Energy Fishing, Fish. Technol.*, (Special Issue on Low Energy Fishing) Society of Fisheries Technologists (India), Cochin: 107-111
- Meenakumari, B., Radhalakshmi, K. and Panicker, P.A. 1995. Weathering of Nylon Netting Yarns, *Fish. Technol.*, 32: 85-88
- Menon, T.R. 1980. *Inventory of Kattaumarams and their Fishing Gear in Andhra Pradesh and Tamil Nadu*, BOBP/WP/2-GCP, RAS/040/SWE, 80p.
- Miyamoto, H. 1956. *Fishing Gear and Methods* (Gyogu Gyho Gaku – in Japanese), Kanahara Publishing House, Tokyo, Japan
- Miyamoto, H. 1962. *A Field Manual Suggested for Fishing Gear Surveys* (in mimeo), Central Institute of Fisheries Technology, 15p.
- Miyazaki, C. 1964. Discussion on Gill Netting and Long Lining etc. In: *Modern Fishing Gear of the World, Vol. 2*, Kristjansson, H.(Ed.). Fishing News Books Ltd., London: 291-292
- Mohan Rajan, K.V., George, M.P., Manohara Doss, R.S. and Pravin, P. 1991. Studies on Polypropylene Gill Nets, *Fish. Technol.*, 28: 1-4
- Molin, G, 1959. Test with Nylon Fishing Tackle in Swedish Inland Fisheries. In: *Modern Fishing Gear of the World, Vol.1.*

- Kristjonsson, H. (Ed.), Fishing News (Books) Ltd., London:  
156-158
- Mugas, N. 1959. Experiments with Synthetic Materials in the Norwegian Fisheries, In: *Modern Fishing Gear of the World, Vol 1.* Kristjonsson, H.(Ed.), Fishing News (Books) Ltd., London:  
159-162
- Mukundan, M. and Hakkim, L.A. 1980. *Purse Seining Development in Indian Waters*, Integrated Fisheries Project, Ministry of Agriculture, Bulletin No. 3, 59 p.
- Mukundan, M. and Mathai, T.J. (unpublished). On the Distribution of Vertical Forces in Gill Nets.
- Mukundan, M. and Narayanan, K.P. 1975. *Fishing Gear Materials*, Central Institute of Fisheries Operatives, Cochin, India, 57p.
- Munasinghe, H. 1985. Socio economic Condition of Small Scale Fisheries in Sri Lanka, In: *Small Scale Fisheries in Asia: Socio-economic Analysis and Policy* (Panayotou,T.(Ed.), International Development Research Centre, Ottawa: 56-73
- Muthiah, C. 1982. Drift Gill Net Fishery of the Dakshina Kannada Coast, *Mar. Fish. Infor. Serv. T&E Ser.*, 37: 8-15
- Nair, 1953. Studies on the Revival of the Indian Oil Sardine Fishery, *Proc. Indo Pacif. Fish. Counc.*, 1952, Sec. 2: 115-129

- Narayanappa, G., Rama Rao, S.V.S., Rao, J.S. and Naidu, R.M. 1993. Operation of Multimesh Gill Nets in Kakinada Bay, In: *Low Energy Fishing, Fish. Technol.*, (Special Issue on Low Energy Fishing) Society of Fisheries Technologists (India), Cochin: 168-169
- Nayar, S.G. 1958. A Preliminary Account of the Fisheries in Vizhinjam, *Indian J.Fish.*, 5(1): 32-55
- Nayar, S.G., Radhalakshmi, K. and Meenakumari, B. 1985. Polypropylene Netting Yarns, In: *Harvest and Post-harvest Technology of Fish.* Ravindran, K., Unnikrishnan Nair, N., Perigreen, P.A., Madhavan, P., Gopalakrishna Pillai. A.G., Panicker, P.A. and Mary Thomas (Eds.) Society of Fisheries Technologists (India), Cochin: 269-271
- Nedelec, C. 1975. *FAO Catalogue of Small Scale Fishing Gear*, Fishing News (Books) Ltd., Farnham, Surrey, England: 191 p.
- Neethiselvan, N., Jude, D., Sundaramoorthy, B. and Gopalakrishnan, P. 2000. Optimization of Mesh Size of Gill Nets to Capture *Amblygaster Sirm* (Walbaum) in Thoothukkudi Coastal Waters, Southeast Coast of India, *Fish. Technol.*, 37(2): 73-76
- Nielsen, L.A. and Lackey, R.T. 1980. Introduction, In: *Fisheries Management*, Lackey, R.T. and Nielsen, L.A. (Eds.) Blackwell Scientific Publications: 3-14

- Nikita, G., Menon, J.S. and Annamalai, V. 2000. Technology Induced Productivity in Fisheries, *Fish. Technol.*, 37(1): 63-68
- Njoku, D.C. 1991. Comparative Efficiency and Techno-Economics of Multifilament and Monofilament Gillnets on the Oguta lake, Nigeria, *Fish. Res.*, 12: 23-30
- Noble, A. 1982. Distribution of the Indian mackerel, *Rastrelliger kanagurta* (Cuvier) along the Coasts of India in 1979 and 1980. *Mar. Fish. Infor. Serv. T & E Ser.*, 36: 7-15
- Noble, A. and Narayanankutty, V.A. 1978. Economics of the Indigenous Fishing Units of Cochin: A case study, *CMFRI Sp. Pub. No. 4*: 24p.
- Nomura, M. 1959. On the Behaviour of Fish Schools in Relation to Gill Nets, In: *Modern Fishing Gear of the World Vol. 1*, Kristjonsson, H. (Ed.), Fishing News (Books) Ltd., London: 550-553
- Nomura, M. 1961. Studies on Gill Nets, 1. Performance of Gill Nets and Reaction of Fish to the Net (in Japanese with English summary), *Bull. Tokai. Reg. Fish. Res. Lab.*, 30: 9-56
- Northridge, S.P. 1991. Drift Net Fisheries and Their Impact on Non-Target Species: A Worldwide Review. *FAO Fish. Tech. Pap. No. 320*, FAO, Rome, 115p.

- Pajot,G. 1980 a. *Improvement of Large Mesh Drift Nets for Small Scale Fisheries in Sri Lanka*, BOBP/WP/3 Madras, India: 12p.
- Pajot,G. 1980 b. *Improvement of Large Mesh Drift Nets for Small Scale Fisheries in Bangladesh*, BOBP/WP/5, Madras, India: 11p.
- Pajot, G. and Das, T.K. 1981. *Trials in Bangladesh of Large Mesh Driftnet of Light Construction*, BOBP/WP/12. Madras, India: 13p.
- Pajot, G. and T.K. Das. 1984 *Fishing Trials with Small- Mesh Driftnet in Bangladesh*, BOBP/WP/28. Madras, India: 13p.
- Panayotou, Y., Adulavidhaya, K., Artachinda, S. Isvilanond, A. S. and Jitsanguan, T. 1985. Socioeconomic Conditions of Coastal Fishermen in Thailand-A Cross Sectional Profile, In: *Small Scale Fisheries in Asia: Socio -economic Analysis and Policy* (Panayotou, T. (Ed.), International Development Research Centre, Ottawa: 46-54
- Panikkar, P.A., Sivan, T.M., Mhalathkar, H.N. and Mathai, P.G. 1978. Selectivity of Gill Nets for *Hilsa ilisha* and *Pampus argenteus*, *Fish. Technol.*, 15(1): 61-68
- Panikkar, K.K.P., Sathiyadhas, R. and Jacob, T. 1990. Comparative Economic Efficiency of Different Types of Mechanized Fishing Units Operating Along Kerala Coast, *J. Mar. Biol. Ass. India*, 32(1&2): 97-106

- Panikkar, K.K.P., Sathiadas, R. and Kanakkan, A. 1993. A Study on Economics of Different Fishing Techniques Along Kerala Coast with Special Reference to Fuel Efficiency, In: *Low Energy Fishing, Fish. Technol.*, (Special Issue on Low Energy Fishing) Society of Fisheries Technologists (India), Cochin: 265-271
- Pauly, D. 1984. *Fish Population Dynamics in Tropical Water, A Manual for Use with Programmable Calculators*. (ICLARM Studies and Reviews, 8). ICLARM, Manila, Philippines, 325p.
- Pet, J.S., Pet, S.C. and Vandensen, W.L.T. 1995. Comparison of Methods for the Estimation of Gill Net Selectivity to Tilapia, Cyprinids and other Fish Species in a Sri Lankan Reservoir, *Fish. Res.*, 24: 141-164
- Pillai, N. S. 1989. An Overview of Shark Gill Netting in Gujarat, *Fishing Chimes*, 9(7): 37-42
- Pillai, N.S. 1993. Results of the Trial Fishing with Polyethylene Gill Net at Kalpeni Island (Lakshadweep), In: *Low Energy Fishing, Fish. Technol.*, (Special Issue on Low Energy Fishing) Society of Fisheries Technologists (India), Cochin: 195-196
- Pillai, N.S., Boopendranath, M.R. and Kunjipalu, K.K. 1989. Studies on the Suitability of HDPE Material for Gill Nets, *Fish. Technol.*, 26: 1-3

- Pillai, P.K.M., Batcha, H.K., Seetharaman, S. and Subramani, S. 1991. On the Catch Trend of Mechanised Gill Netters Landed at Madras Fisheries Harbour, *Mar. Fish. Infor. Serv. T&E Ser.*, 108: 11-12
- Pradhan, L. 1956. Mackerel Fishery of Karwar, *Indian J. Fish.*, 3(1): 141-185
- Prado, J. 1990. *Fisherman's Workbook*, Fishing News Books, Oxford: 180p.
- Pravin, P. and Ramesan, M.P. 2000. Polyamide Monofilament Gill Nets in Gujarat, *Fishing Chimes*, 19(12): 55-56
- Pravin, P., Ramesan, M.P. and Mathai, P. G. 1998. Gill Net Fishing in Gujarat, In: *Advances and Priorities in Fisheries Technology*, Balachandran, K.K., Iyer, T.S.G., Madhavan, P., Joseph, J., Perigreen, P.A., Raghunath, M.R. and Varghese, M.D. (Eds.), Society of Fisheries Technologists (India), Cochin: 170-176
- Psuty, I. 1996. The Characterization of the Selectivity of Gill Nets Currently Used in Pike Perch Catches in the Polish Part of the Vistula Lagoon, *Bull. Sea Fish. Inst.*, 139: 13-28
- Psuty, I. and Borowski, W.I. 1997. The Selectivity of Gill Nets to Bream (*Abramis brama* L.) Fished in the Polish Part of the Vistula Lagoon, *Fish. Res.*, 141: 249-561



- Qasim, S.Z. 1973. Some Implications of The Problem of Age and Growth in Marine Fisheries from the Indian Waters, *Indian J. Fish.*, 20(2): 351-370
- Radhalakshmi, K. 1989. *Studies on Polypropylene as Fishing Gear Material*, M.Sc. Thesis, Cochin University of Science and Technology, Cochin, 74p.
- Radhalakshmi, K. 1995. Fishing Gear Materials, In: Training course on *Extension Methodologies and Fishery Technological Innovations*, CIFT (ICAR), Cochin: 1-18
- Radhalakshmi, K. and Nayar, S.G. 1973. Synthetic Fibres for Fishing Gear, *Fish. Technol.*, 10(2): 142-165
- Radhalakshmi, K. and Nayar, S. G. 1985. Fishing Experiments With Newer Materials, In: *Harvest and Post-harvest Technology of Fish*, Ravindran, K., Unnikrishnan Nair, N., Perigreen, P.A., Madhavan, P., Gopalakrishna Pillai, A.G., Panicker, P.A. and Mary Thomas (Eds.) Society of Fisheries Technologists (India), Cochin: 262-263
- Radhalakshmi, K., Sivan, T.M. and Paul, V. 1993. Experiments with Polyethylene Yarn Gill Nets, In: *Low Energy Fishing*, *Fish. Technol.*, (Special Issue on Low Energy Fishing) Society of Fisheries Technologists (India), Cochin: 119-120

- Rao, P.V. 1968. Maturation and Spawning of the Penaeid Prawns of the Southwest Coast of India, *FAO Fish. Rep.*, 57(2): 285-302
- Rao, S.G., Suseelan, C. and Lalitha D. C. 1980. Impact of Mesh Size Reduction of Trawl Nets on the Prawn Fishery of Kakinada in Andhra Pradesh, *Mar. Fish. Infor. Serv. T & E Ser.*, 21: 1-5
- Rao, S.S., Chandra Sekhar, S. and Rao, P.M. 1994. Monofilament Made Botton Set Gill Net Proves More Efficient along the Andhra coast, *Mar. Fish. Infor. Serv. T & E Ser.*, 128: 5
- Regier, H.A. and Robson, D.S. 1966. Selectivity of Gill Nets, Especially to Lake White Fish, *J. Fish. Res., Board Can.*, 23: 423-454
- Reis, E.G. and Pawson, M.G. 1992. Determination of Gill Net Selectivity for Bass (*Disentrarchus Labsase L.*) Using Commercial Catch Data, *Fish.Res.*, 13: 173-187
- Riedel, D. 1963. Contribution to the Experimental Determination of the Selection Parameter of Gill Nets, *Arch. Fischereuriss*, 14: 85-97
- Rugger, G.R. 1968. *Weathering in Environmental Effects on Polymeric Materials, Vol.I Environments*, Rosato, D.V. and Swartz, J. (Eds.). Newyork, Interscience: 339-411

- Rummler, H.J. 1954. Perlon Fibre as A Material for Fishing Gear, *Zeitschrift fur fischerei.*, 3(1/3): 27-110
- Sainsbury, J.C. 1971. *Commercial Fishing Methods*, Fishing News (Books) Ltd., London, 119 p.
- Sainsbury, J.C. 1996. *Commercial Fishing Methods-An Introduction to Vessels and Gear*, Fishing News Books (Ltd), Farnham, 352p.
- Samaranayaka, A., Engas, A. and Jorgensen, T. 1997. Effects of Hanging Ratio and Fishing Depth on the Catch Rates of Drifting Tuna Gill Nets in Sri Lanka Waters, *Fish. Res.*, 29: 1-12
- Satyanarayana, A.V.V. and Sadanandan, K.A. 1962. 'Chalavala' Encircling Gill Nets for Sardines and Mackerels of the Kerala Coast with Special Reference to Their Design and Construction, *Indian J. Fish.*, 9 (1B): 145 - 155
- Sehera, D.B.S. and Karbhari, J.P. 1989. Economics of Gill Net Fishing by OBM Units at Selected Centres in North West Coast, *Mar. Fish. Infor. Serv. T&E Ser.*, 98: 1-8
- Sehera, D.B.S., Sathiadas, R., Panikkar, K.K.P. and Kumar, R.N. 2000. Economic Evaluation of Different Types of Fishing Methods along Indian Coast, In: *Marine Fisheries Research and Management*, Pillai, V.N. and Menon, N.G. (Eds.), Central Marine Fisheries Research Institute, Cochin: 846-857

- Shibu, A.V. 1999. *Comparative Efficiency of Different Types of Mechanised Fishing Operations along the Cochin Coast*, Ph.D. Thesis. Cochin University of Science and Technology, Cochin, 217p.
- Shimozaki, Y. 1964. Production and Characteristics of Synthetic Nets and Ropes in Japan, In: *Modern Fishing Gear of the World Vol 2*, Kristjonsson, H.(Ed.), Fishing News (Books) Ltd., London: 66-70
- Shon, T.J. 1978. On the Catch of Gill Nets in the Jeju Island, Comparison of Mackerel Catch in Monofilament and Multifilament Gill Nets, *Bull.Korean Fish.Soc.*, 8(1): 7-10
- SIFFS, 1991. *The Census of the Artisanal Fishing Fleet of Kerala*, South Indian Federation of Fishermen Societies, Trivandrum, 122 p.
- SIFFS, 1999. *A Census of the Artisanal Marine Fishing Fleet of Kerala*, South Indian Federation of Fishermen's Societies, Trivandrum, 132p.
- Silas, E.G., Rajagopalan, M.S. and Parameswaran, P. 1979. Tuna Fisheries in India: Recent Trends, *Mar. Fish. Infor. Serv. T&E Ser.*, 13: 1-10
- Silas, E.G., Pillai, P.P., Jayaprakash, A.A. and Pillai, M.A. 1984. Focus on Small Scale Fisheries: Drift Gill Net Fishery off Cochin, 1981 and 1982. *Mar.Fish. Infor. Serv. T&E Ser.*, 55: 1-12

- Singleton, R.W, Kunkel, R.K. and Sprague, B.S. 1965. Factors influencing the Evaluation of Actinic Degradation of Fibres, *Textile Res. J.*, 35: 228-237
- Sivadas, M. 1994. Present Status of The Drift Net Fishery at Vellayil, Calicut, *Mar. Fish. Infor. Serv. T&E. Ser.*, 127: 1-4
- Snedecor, W.G. and Cochran, G.W. 1956. *Statistical Methods Applied to Experiments in Agriculture and Biology*, The Iowa State University Press, Ames, Iowa, USA, 534p.
- Somvanshi, V.S. 1980. *Proc. Indian Nat. Sci. Acad.*, B 46 No.1: 105-13
- Sparre, P., Ursin, E. and Venema, S.C. 1989. Introduction To Tropical Fish Stock Assessment Part-I. Manual, *FAO Fish. Tech. Paper*. No. 306.1 Rome, FAO, 337p.
- Sreekrishna, Y., Sitarama Rao, J., Dawson, P., Mathai, T.J. and Sulochanan, P. 1972. Mesh selectivity for spotted seer *Scomberomorus guttatus* (Bloch and Schaneeder), *Fish. Technol.*, 9(2): 133-138
- Steinberg, R. 1964. Monofilament gill nets in freshwater experiments and practice, In: *Modern Fishing Gear of the World, Vol. 2* Fishing News (Books) Ltd., London: 111-115
- Stewart, P.A.M. and Ferro, R.S.T. 1985. Measurements on Gill Nets in a Flume Tank, *Fish. Res.*, 3: 29-46

- Strzyzewski, W. 1964. Methods of calculating the selectivity factor, *Prace Morsk. Inst. Rybade, Ser.B* (transl from polish, available from U.S. Dep Commer. *Natl. Tech. Inf. Serv.*, Springfield VA), 12: 39-56
- Sulochanan, P., George, V.C. and Naidu, R.M. 1968. Experimental fishing in Hirakud reservoir, Orissa, *Fish. Technol.*, 5(2): 81
- Sulochanan, P., Sadanandana, K.A., Mathai, J.P. and Syed Abbas, M. 1975. Selectivity of Gill Nets for *Scomberomorous commersoni*, *Fish. Technol.*, 12(1): 52-59
- Suseelan, C. and Rajan, K.N. 1993. Marine Prawn Production in Low Energy Fishing Sector of Indian Coast- Present Trend and Future Prospects, In: *Low Energy Fishing, Fish. Technol.*, (Special Issue on Low Energy Fishing) Society of Fisheries Technologists, India, Cochin: 19-29
- Thomas, D. 1964. Discussion on Gill Netting and Long Lining, In: Kristjonsson, H. (Ed.) *Modern Fishing Gear of the World 2. Fishing News (Books) Ltd.*, London, England: 292
- Thomas, S.N. 2000. Shrimp Trawling with Motorised Traditional Crafts, *Infofish Int.*, 1/2000: 60-61
- Thomas, S.N. and Hridayanathan, C. 1998. Need for Monitoring Monsoon Fishery of Kerala, *Fishing Chimes*, 18(7): 42-44

- Thomas, S.N. and Hridayanathan, C. (in press). Gill Nets of Kerala Coast, *Fish. Tech.*
- Thomas, S.N. and Hridayanathan, C. (in press). Small Mesh Gill Netting: A Catch Analysis with Special Reference to Juveniles, presented in the *National symposium on 'Sustainable Development of Fisheries Towards 2000 AD-Opportunities and Challenges*, held at Cochin during 21-23 April 1999.
- Thomas, S.N., Kuttappan, A.C., Varghese P., George, V.C. and Iyer, H. K. 1993. Relative Efficiency of Gill Nets and Trammel Nets: A Preliminary Study, In: *Low Energy Fishing, Fish. Technol.*, (Special Issue on Low Energy Fishing) Society of Fisheries Technologists (India), Cochin: 191-194
- Thomson, D. 1980. Conflict within the Fishing Industry, *Naga*, ICLARM Quarterly, ISSN, 116-290 X: 3-4
- Tokrishna, R., Panayotou, T. and Adulavidhaya, K. 1985. Small Scale Fisheries in Asia: Socioeconomic Analysis and Policy, In: *Small Scale Fisheries in Asia: Socio Economic Analysis and Policy* (Panayotou, T. (Ed.), International Development Research Centre, Ottawa: 96-101
- Umali, A. 1957. Guide to the Classification of Fishing Gear in the Philippines-*FAWS Research Report*, No. 17.

- Verghese, C.P. 1994. *Techno-economic Studies in Industrial Fishing in the Upper East Coast of India*, Ph.D. Thesis, Cochin University of Science and Technology, Cochin, 194p.
- Varshney, R.L. and Maheshwari, K.L. 1981. *Managerial Economics*, Sultan Chand and Sons, New Delhi, 446p.
- Vendeville, P. 1990. Tropical Shrimp Fisheries: Types of Fishing Gear Used and their Selectivity, *FAO Fish. Tech. Paper*, No. 261 (Rev.1), Rome, FAO, 1990, 75p.
- Vijayan, V., Varghese, M.D., Edwin, L., Thomas, S.N. and George, V.C. 1993. Coastal Gill Nets of Kerala-Changes in Three Decades, In: *Low Energy Fishing, Fish. Technol.*, (Special Issue on Low Energy Fishing) Society of Fisheries Technologists (India), Cochin: 172-176.
- Weber, P. 1994. *Net Loss, Jobs and the Marine Environment*, World watch Institute, Massachusetts Ave, Washington, 148p.
- Yater, F. 1982. Gill Netters: Costs, Returns and Sharing Systems, In: *Small Scale Fisheries of San Miguel Bay, Philippines: Economics of Production and Marketing*, Smith, I.R. and Mines, A.N. (Eds). ICLARM. Technical Reports 8: 27- 44
- Yatsu, A. and Watanabe, Y. 1987. Mesh Selectivity of Gill Nets for Slender Tuna ( *Allothunnus fallai* serventy (Scombridae), *Bull. Jap. Soc. Sci. Fish.*, 53(6): 947



- Yohannan, T.M. and Balasubramanian, K.K. 1989. Drift Net Fishery at Calicut with Special Reference to Scombroids, *Mar. Fish. Infor. Serv. T&E Ser.*, 95: 1- 4
- Yohannan, T.M., Radhakrishnan, Nair, P.N., Pillai, N.G.K. and Ammini, P.L. 1999. Marine Fisheries in Kerala, *Mar. Fish. Infor. Serv. T&E Ser.*, 160: 1-23
- Zaucha, J. 1964. New Synthetic Herring Driftnets Used in the North Sea, *Modern Fishing Gear of the world Vol. 2*. Kristjonsson, H.(Ed.) Fishing News (Books) Ltd., London: 73-87

