

**Design and Development of Instrumentation
Systems to determine the Dry Rubber Content in
Natural Rubber Latex**

Thesis submitted to

COCHIN UNIVERSITY OF SCIENCE AND TECHNOLOGY

in partial fulfillment of the requirements for the award of the

degree of

DOCTOR OF PHILOSOPHY



REJI KUMAR, R.

DEPARTMENT OF INSTRUMENTATION,

COCHIN UNIVERSITY OF SCIENCE AND TECHNOLOGY,

KOCHI-682 022.

December 2009

CERTIFICATE

Certified that the work presented in this thesis is based on the bona fide work done by Sri. Reji Kumar, R., under my guidance in the Department of Instrumentation, Cochin University of Science and Technology and has not been included in any other thesis submitted previously for the award of any degree.

Kochi,
02.12.2009

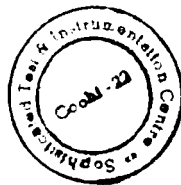

A handwritten signature in black ink, appearing to read "Dr. Jacob Philip".

Dr. Jacob Philip,
Professor (Supervising Guide)

&

Director,
Sophisticated Test and Instrumentation Centre,
Kochi-22

DECLARATION

Certified that the research work presented in this thesis is based on the original work done by me under the guidance of Dr. Jacob Philip, Professor (Director, STIC), Department of Instrumentation, Cochin University of Science and Technology and has not been included in any other thesis submitted previously for the award of any degree.

Kochi-22

02.12.2009



Reji Kumar, R.,

Research Scholar,

Department of Instrumentation, CUSAT,

Kochi-22.

Acknowledgements...

The work presented in this thesis has been carried under the guidance and supervision of Dr. Jacob Philip, Professor & Director, Sophisticated Test and Instrumentation centre, Cochin University of Science and Technology, Kochi-22. I express my deep sense of gratitude to him for his able, inspiring and patient guidance, constructive suggestions, constant support and encouragement at every stage of work, without which this endeavor would not have been completed. I wish to express my sincere thanks to Dr. K. N. Madhusoodanan, Head of the Department of Instrumentation, Cochin University of Science and Technology, Kochi-22 for extending the departmental facilities to carry out the research work.

I thank the Sophisticated Analytical Instrument Facility (SAIF) at STIC, CUSAT for extending the facilities to carry out various measurements for the research work. I thankfully acknowledge the help extended by Dr. Shibu Eapen, Sri. Adarsh, K.J., Sri. Saji, T.K., Sri. Shyam Kumar, S., Sri. Melvin Baby and Mrs. Smitha, N.M., members of staff of SAIF. I express my sincere thanks to my fellow Research Scholars at Department of Instrumentation, CUSAT for their help during the course of this work.

I thank Dr. James Jacob, Director, Dr. N.M. Mathew, Former Director, Sri. Najamul Hussain S, former Instrumentation Engineer, Rubber Research Institute of India, Kottayam for extending the facilities at RRII, their support and help in completing this research work.

My thanks are also due to Mr. M. Sunny Sebastian, Joint Director and Dr. M. M. Ponnamma, Rubber Chemist, Department of P&PD, Sri. Ramesh B Nair, Assistant Director (Statistics), Sri Biju, Assistant Director (systems), Sri. Aneesh, P., Statistical Inspector, Sri. Hari Kumar, Scientific Assistant, RRII for their help in completing this research work.

I thank the Kerala State Council for Science Technology and Environment for extending the financial assistance for the project work. I extend my sincere thanks to Sri. V.C Kunju Kutty, Sri. K.D.Mathai and Sri.Sukumaran, rubber tappers of the RRII Farm, members of Staff and workers of the Pilot Crumb Rubber Factory for their help in completing this work. My thanks are also due to Sri. Rajendran, Worker, RRII Farm for helping me in many ways during the course of the research work.

Finally, I extend my sincere thanks to my Parents, Spouse and Children for their help and encouragement in completing this research work.

(REJI KUMAR, R)

Preface

Hevea brasiliensis, a forest tree, is the only major commercial source of natural rubber (NR) in the world. Polyisoprene extracted from *Hevea brasiliensis* is known as Natural Rubber. The elastic properties of NR have eventually led to a multi-billion dollar industry world wide and a source of livelihood for several million people across the globe. In India commercial cultivation of *Hevea* had started in the year 1902. In terms of productivity, growth in area, production and the extent of price realization, the Indian rubber plantation industry is ahead of all other major natural rubber producing countries in the world. Today, India is the fourth highest producer of rubber in the world having a total of 554000 hectares under rubber cultivation with a total production of 605045 tons per year.

Hevea brasiliensis, once planted in the field, will become a mature tree over a span of 6 -7 years and is ready for harvesting. During fresh tapping by a process of wounding, white milky fluid coming out of the *Hevea* tree before preservation or concentration is known as field latex. Latex is a special form of cytoplasm containing a suspension of rubber and non-rubber particles in an aqueous serum. Besides rubber and water, fresh latex contains Luteoids, carbohydrates, proteins, lipids and

inorganic salts. Concentrated latex as such is used for manufacturing several latex based products. Latex collected from the field is coagulated, processed and dried under standard conditions to produce raw natural rubber, which is used for the manufacture of various rubber based goods, including automobile tyres.

This thesis embodies the work done by me on the development of instrumentation techniques to measure the dry rubber content in natural rubber latex.

Importance of Dry Rubber Content (DRC)

Dry Rubber Content or DRC is an important parameter for natural rubber latex (NRL), which is to be measured quickly for various purposes for the rubber industry. DRC is defined as the mass in grams of solid rubber present in 100 g of latex. The DRC of latex varies depending upon season, tapping system, weather, soil conditions, clone of the tree and environmental conditions. The DRC of *Hevea* latex is a very familiar term to all in the rubber industry. It is probably one of the few properties of latex first recognized and widely used for trade and processing, ever since the commencement of commercial exploitation of *Hevea* trees. The DRC is an essential parameter for ensuring fair prices for latex during commercial exchange. It has been the basis for incentive payments to tappers who bring in more than the daily agreed poundage of latex rubber. It is an important parameter that determines the yield of useful

rubber from any latex, and is required for various decision making processes in the automation of industrial processes in rubber products manufacturing.

Techniques to measure DRC

The most accurate method to determine the DRC of latex is the Standard Laboratory Method (SLM). The general procedure of this method is to coagulate a known weight of the representative latex sample with dilute acetic acid, sheet the coagulum and dry it at about 75°C in an oven for nearly 12 hours. The DRC of the latex is given by the percentage by weight of the dry sheet over the weight of the latex taken. Numerous other methods have also been cited in literature for the measurement of the DRC of latex. The hydrometer is probably the most rapid one, even though its accuracy is limited by a wide range of conditions encountered in practice. For latex, the average error of the measurement with hydrometer is about 4% of the value estimated by the standard laboratory method. The 'Spot Method' is popular in many laboratories, which uses an accurate weighing balance to weigh the coagulum from a 0.3 g sample dried on a steam bath oven and expressed as a percentage of the original mass. The measurement time is about 30 minutes, with an error of about 1%. The main disadvantages of these drying and weighing methods are that they are time consuming and labor intensive.

Other methods that have been reported in literature for the determination of DRC include Viscosity method, Latex film dialysis, Titration method, Microwave attenuation, Low resolution pulsed NMR technique, Spin eco- technique etc. The shortcomings of these methods are that they either require a specialist for measurements, they are time consuming, expensive, have limited accuracy or could not be adapted for field measurements.

Due to these limitations the above methods have not gained much popularity among stakeholders in the rubber industry. The NR industry is still in need of a viable, inexpensive and accurate method to determine the DRC of natural rubber latex. In view of this scenario we decided to undertake research work on development of DRC measurement techniques, with the following definite objectives.

Objectives of the work

- 1) Study various characteristic properties of natural rubber latex following different optical, dielectric and thermal instrumentation techniques and develop measurement techniques that are fast, accurate and economical for the determination of the DRC of natural rubber latex.
- 2) Use the Scientific information collected from the research work to design and develop a viable and accurate DRC measurement

instrument which is user friendly, fast, inexpensive and usable in the field.

Outline of the work

Initially, we studied various characteristic properties of natural rubber latex, such as optical absorption in the MIR region and thermal properties by thermo-gravimetric analysis (TGA). In the second phase, we designed and fabricated a special capacitive transducer to measure the variations of the dielectric properties of latex samples with their DRC values. Then we conducted a series of measurements to study the variation of optical absorption of latex samples in the near Infrared (NIR) region with the corresponding DRC values. Finally, we conducted Differential Scanning Calorimetric studies on different latex samples to understand the relation between change in enthalpy per unit mass over a defined temperature range of the samples and their corresponding DRC values. In all these methods direct relationship between DRC values and the relevant measurands have been established experimentally. We have developed these five measurement techniques for the estimation of DRC of natural rubber latex and the information collected from these studies have been used to design and develop practical DRC measurement systems wherever possible.

Organization of the thesis

The thesis is presented in six chapters as outlined below.

Chapter One: Review of the Existing Techniques for the Determination of Dry Rubber Content in Natural Rubber latex

A brief history of *Hevea brasiliensis* and Indian rubber plantation sector is included in the first part of this chapter. Subsequently, we have included a brief description of the properties of latex, importance of DRC in NR industry and the technical details of the different known techniques used for the determination of the DRC of latex. Finally, a brief summary of the shortcomings of the existing DRC measurement methods and an outline of the entire research work are presented.

Chapter Two: Estimation of Dry Rubber Content in Natural Rubber Latex by FTIR Spectroscopy and TGA Techniques

This chapter embodies the work done and results obtained with analytical techniques such as Infrared optical absorption and thermogravimetric analysis. A general description of Infrared absorption measurements using a Fourier Transform Infrared Spectrometer and its various applications are included in this chapter, followed by a brief outline of the experimental set up for absorption measurements, method of sample preparation, results obtained and a discussion of the results. We have been able to establish a linear relation between IR absorption

around 835 cm^{-1} with the DRC values of NR latex samples. Work done on thermal analysis following Thermo Gravimetric Analysis (TGA) is also presented in this chapter. The details of the experimental setups, methods of sample handling, experimental details, results and discussion etc for these measurements are included in the latter part of this chapter.

Chapter Three: Measurement of Dry Rubber Content of Natural Rubber Latex with a Capacitive Transducer

In this chapter we have presented and discussed various applications of capacitive transducers, principle of the capacitance method, constructional details of a capacitive transducer designed by us and experimental set up used for measurements. The results obtained from a series of measurements are compiled and presented in the later part of the chapter, followed by a discussion of the results. In this method we have established a correlation between dielectric properties, such as dielectric constant, dielectric loss, a.c. conductivity etc of latex and with the corresponding DRC values. The limitations and shortcomings of the capacitance method are discussed in detail.

Chapter Four: Near IR Spectral response of Natural Rubber Latex in the Reflectance Mode

This chapter begins with a general description of the near IR absorption spectroscopy. Various applications of NIR spectroscopy in

agriculture, medical and dental sciences are subsequently discussed. The theory of optical absorption, experimental method developed and the results obtained from the measurements are included in the second part of this chapter. We have developed a spectral reflectance technique for the measurement of optical absorption in the NIR region. The details of the technique and the results obtained are presented in this chapter. A direct proportionality between NIR reflectance intensity at 1460 nm and DRC has been established. Finally the results obtained are compiled and discussed.

Chapter Five: Estimation of Dry Rubber Content in Natural Rubber Latex by Differential Scanning Calorimetry

A general description of differential scanning calorimetry (DSC) and its various applications, with a special reference to thermal analysis of polymers, are included in the first part of this chapter. We have shown that the mass normalized change in enthalpy in a defined temperature range is proportional to the DRC of latex samples. The principle of the method, experimental method adapted and the results obtained are presented and discussed in the second part of the chapter. Finally, the results obtained from the DSC measurements are compiled and we have established a correlation between mass normalized areas and the corresponding DRC values of latex samples. Subsequently the results

are discussed and general conclusions drawn from the investigations which are presented chapter five.

Chapter Six: Summary and Conclusions

In this chapter a summary of entire research work carried out is included. The overall conclusions drawn from the work and scope for doing further research in DRC measurement techniques are also presented in this chapter.

Papers published

- (1) Reji Kumar, R., Najamul Hussain, S and Philip, J., Measurement of Dry Rubber Content of Natural Rubber Latex with a Capacitive Transducer, *Malaysian J. Rubb. Res.* (2007) **10 (1)**: 19-25
- (2) Reji Kumar, R and Philip J., Determination of Dry Rubber Content in Natural Rubber Latex from NIR Reflectance Measurement, *Proc. of the Kerala Science Congress* (2009) **10-16**:774-776

Popular article published

- (1) R. Reji Kumar and Philip, J., DRC Determination: New Experiments, *Rubber (Malayalam)* (2009) **515**:35-36.

Presentations in Seminars/ Symposia

- (1) Reji Kumar, R., Najamul Hussein, S and Philip, J., Measurement of Dry Rubber Content of Natural Rubber Latex with a Capacitive

Transducer, presented at the National symposium on Instrumentation held at CUSAT during 30th November - 2nd December, 2006.

- (2) Reji Kumar, R., Najamul Hussein, S and Philip, J., Measurement of Dry Rubber Content of Natural Rubber Latex with a Capacitive Transducer, presented in the 366th Scientific Seminar of the Rubber Research Institute of India, held on 22nd December, 2005.
- (3) Reji Kumar, R., and Philip, J., Estimation of Dry Rubber Content in Natural Rubber Latex by Differential Scanning Calorimetry, presented in the 412th Scientific Seminar of the Rubber Research Institute of India held on 29th May, 2009.
- (4) Reji Kumar, R. and Philip, J., Near IR Spectral Response of Natural Rubber Latex in the Reflectance Mode, presented in the 417th Scientific Seminar of the Rubber Research Institute of India held on 13th August, 2009

Papers communicated

- (1) Reji Kumar R. and Philip, J., Estimation of Dry Rubber Content in Natural Rubber Latex by Differential Scanning Calorimetry, submitted to *Journal of Thermal Analysis and Calorimetry* (2009).
- (2) Reji Kumar R. and Philip, J., Near IR Spectral Response of Natural Rubber Latex in the Reflectance Mode, submitted to *Journal of Applied Polymer Science* (2009).

- (3) Reji Kumar, R and Philip, J., Estimation of Dry Rubber Content in Natural Rubber Latex by FTIR Spectroscopy and TGA techniques, J. Analytical Sciences (2009).

CONTENTS

Acknowledgements	i - ii
Preface	iii - xiii
Chapter One: Review of the Existing Techniques for the Determination of Dry Rubber Content in Natural Rubber Latex	1 - 32
1.1: Introduction	1
1.2: The Physiology and Biochemistry of Latex	3
1.3: Rubber Biosynthesis and its Polymerization	4
1.4: The Importance of Dry Rubber Content of NR Latex	6
1.5: Techniques to Determine DRC of Latex: An overview	8 - 19
1.5.1: The Standard Laboratory Method	8
1.5.2: The Hydrometer Method	10
1.5.3: The Latex Film Dialysis	11
1.5.4: The Microwave Technique	13
1.5.5: The Specific Heat Method	14
1.5.6: The Low Resolution NMR Technique	15
1.5.7: The Titration Method	17
1.5.8: The Dielectric Method	19

1.6 : Shortcomings of the existing methods	19
1.7: Outline of the Work presented in this Thesis	21
<i>References</i>	24
Chapter Two : Estimation of Dry Rubber Content in Natural Rubber Latex by FTIR Spectroscopy and TGA Techniques	33 - 66
2.1: Fourier Transform Infrared Spectroscopy	33
2.1.1 : Introduction	33
2.1.2 : Principle of the Method	34
2.1.3 : Experimental Procedure	36
2.1.4 : Results and Discussion	39
2.1.5 : Conclusions	47
2.2.: Thermo Gravimetric Analysis	48
2.2.1 : Introduction	48
2.2.2: Principle of the Method	49
2.2.3 : Experimental Procedure	51
2.2.4 : Results and Discussion	52
2.2.5 : Conclusions	61
<i>References</i>	63

Chapter Three: Measurement of Dry Rubber Content of Natural Rubber Latex with a Capacitive Transducer	67 - 95
3.1 : Introduction	67
3.2 : Principle of the Method	70
3.3:Capacitance Transducer Design and Measurement Method	74
3.3.1: General Description	74
3.3.2: Sample Collection and Preservation for Measurement	77
3.4 : Results and Discussion	78
3.5 : Limitation of the Method	85
3.6 : Conclusions	85
<i>References</i>	87
Chapter Four : Near IR Spectral Response of Dry Rubber Content in Natural Rubber Latex in the Reflectance mode	95 - 127
4.1 : Introduction	95
4.2 : NIR Spectroscopy in Agriculture and Food Sciences	97
4.3 : NIR Spectroscopy in Medical and Dental Sciences	99
4.4 : Near Infrared absorption by molecules	100

4.5 : Experimental method	102
4.6: Treatments with a adulterants	106
4.7 : Results and Discussion	107
4.8 : Conclusions	118
<i>References</i>	119
Chapter Five: Estimation of Dry Rubber Content in Natural Rubber Latex by Differential Scanning Calorimetry	127 - 150
5.1 : Introduction	127
5.2 : Principle of the Method	129
5.3 : Experimental Procedure	131
5.4 : Results and Discussion	133
5.5 : Conclusions	143
<i>References</i>	145
Chapter Six: Summary and Conclusions	150- 153
7.1 : Summary of the work done	150
7.2: Conclusions	152
7.3: Scope for future Work	153

CHAPTER ONE

Review of the Existing Techniques for the Determination of Dry Rubber Content in Natural Rubber Latex

1.1: Introduction

Hevea brasiliensis, a forest tree, which is indigenous to the tropical rain forests of Central and South America and the only major commercial source of natural rubber (NR), is one of the most recently domesticated crop species in the world. The modern age of NR in India actually started during the 1870s when the British successfully transported *Hevea* seeds from Brazil for planting in the then British India^{1,2}. Rubber seems to be a fairly straightforward word. The French call it *Caoutchouc* recognizing its historically South American Indian word, meaning weeping wood^{3,4}. Polyisoprene, especially when chemically modified by vulcanization, has remarkable ability to substantially return to its original shape after being stretched considerably. Any material, which fulfills this requirement, is entitled to be called rubber⁵. The ASTM D 1566 gives a more detailed definition of rubber. Polyisoprene extracted from *Hevea brasiliensis* is called natural rubber (NR). This elastic property of rubber eventually led to a multi-billion

dollar industry worldwide, and has influenced the lives of a large number of people on this planet⁶. The British planters initiated rubber cultivation on a plantation scale and the state administration encouraged them by providing land, labour, capital and trade facilities. In 1862, a policy for the issue of land suitable for the cultivation of plantation crop was formulated⁷. The liberal rules formulated in Travancore during 1860s and subsequently in Cochin for the distribution of forest and wasteland for plantation crops were instrumental for the initial growth and expansion^{8, 9}.

In terms of productivity, growth in area and production and the extent of price realization at the farm gate, the Indian plantation industry is ahead of all the other major natural rubber (NR) producing countries in the world. Owing to the pace of development in the industrial sector, the demand for rubber has been very dynamic⁹.

The organizational structure of the Indian rubber plantation sector is divided between small holdings and estates, the former with 474880 hectares comprising 87 per cent of the total area under rubber cultivation. Large estates constitute a smaller sector with 69654 hectares only. Compared to other plantation crops in the country, rubber has recorded higher annual growth rate in area, production and productivity during the period between 1970-71 and 1994-95, the respective figures being 3.77, 6.92 and 3.08 per cent¹⁰ respectively. Today, India is the fourth largest producer of rubber in the world having a total of 554000 hectares under rubber cultivation with a total production of 605045 tons¹¹.

1.2: The physiology and biochemistry of rubber latex

During fresh tapping by a process of wounding, the white milky fluid coming out of the *Hevea* tree before preservation or concentration is known as field latex. The physiology of *Hevea brasiliensis* is unique¹². Biosynthesis of latex, the economic product, is confined to the latex vessels which exclusively occur in the phloem region. Latex biosynthesis depends on the number, diameter and anatomical characters of latex vessel system and physiological and biochemical factors. The capacity of the latex vessels to synthesize and regenerate latex drained during each tapping is critical and is accomplished in the interval between two successive tappings¹³. Latex is a special form of cytoplasm containing a suspension of rubber and non-rubber particles in an aqueous serum. Besides rubber and water, fresh latex contains lutoids¹⁴, carbohydrates¹⁵, proteins¹⁶⁻¹⁹, lipids²⁰ and inorganic salts²¹.

Latex can be separated into (1) a white upper layer of rubber, (2) an orange or yellow layer containing Frey-Wyssling particles, (3) an aqueous serum named C serum and (4) a bottom fraction containing grayish yellow gelatinous sediments by ultra centrifugation²². The serum contains most of the soluble substances including amino acids, proteins, carbohydrates, organic acids, inorganic salts and nucleotidic materials²³. The dominant particulate constituent of freshly collected latex is rubber hydrocarbon, which occurs in sizes ranging from 0.02 to 3.00 μm with the majority in the region of 0.1 μm ²⁴⁻²⁶. Rubber particles are usually spherical but sometimes oval or pear shaped²⁶ and are strongly protected in suspension by a film of adsorbed

protein and phospholipids²⁷. Fresh latex from the rubber tree is a thixotropic neutral milky fluid of density around 0.98 g/cm³.²⁸ This protein-phospholipid layer imparts a net negative charge to the rubber particles contributing colloidal stability to the liquid²⁹. Natural rubber latex, being a natural product, has variable composition depending on many factors such as the clone, season, soil conditions, tapping method and frequency, age of the tree etc. The typical composition is as follows²⁸.

Component	% by weight of latex
Rubber Content	30-35
Proteinaceous substances	1-1.5
Lipids	1-2.5
Sugar	1
Inorganic ions	1
Water	60-65

1.3: Rubber biosynthesis and its polymerization

Rubber is composed of isoprene units linked together to form a polymer³⁰. The individual steps in the synthesis of rubber from sucrose are well established³¹. Biosynthesis of rubber can be divided into three stages: (1) generation of acetyl-coenzyme A (acetyl-CoA); (2) conversion of acetyl-CoA to isopentenyl pyrophosphate (IPP) via mevalonic acid; (3) polymerization of IPP to rubber. Sucrose in latex is the primary source of

acetate and acetyl-CoA essential for the biosynthesis of rubber. Acetate forms the basic precursor of rubber biosynthesis in all rubber plants³¹⁻³⁵. The mechanism of polymerization of IPP has been elucidated in relation to terpene biosynthesis³⁶. Two steps are involved in the process: (1) isomerization of IPP to dimethylallyl pyrophosphate (DMAPP) by a shift of the double bond by IPP isomerase and (2) condensation of DMAPP with IPP by rubber cis-polyprenyl transferase³⁷⁻⁴⁰, to give a molecule each of pyrophosphate and geranyl pyrophosphate (C 10). This C 10 molecule has allelic structure and repeats the condensation, with another molecule of IPP. The propagation, repeated several times, results in the formation of natural rubber with high molecular weight. The stereo - specificity of rubber transferase enzyme in latex ensures a *cis* configuration for each double bond. Hevea rubber differs from the majority of isoprenoid compounds in two respects. It has high molecular weight which varies from typically one hundred thousand to several millions⁴¹ and the geometric configuration of double bonds is exclusively *cis*⁴²⁻⁴⁴. Natural rubber is a polymer of isoprene, with molecular structure

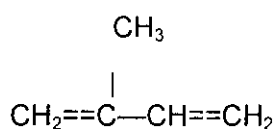

in which all the essential isoprene units are linked together at carbon atoms 1 and 4 in a head-to-tail arrangement, and in which all or nearly all the repeating units possess the "cis" configuration⁴⁵.

1.4: The importance of dry rubber content of NR latex

Hevea latex is a natural biological liquid of very complex composition. Besides rubber hydrocarbons, it contains many proteinous and resinous substances, carbohydrates, inorganic matter, water, and others⁴⁶. The Dry Rubber Content (DRC) of latex varies according to season, tapping system, weather, soil conditions, clone, age of the tree etc.⁴⁷. The true DRC or Total Solid Content (TSC) of the latex must be determined to ensure fair prices for the latex during commercial exchange. DRC is defined as the mass in grams of rubber present in 100 g of latex⁴⁸. The Dry Rubber Content (DRC) of *Hevea* latex is a very familiar term to all in the rubber industry. It is probably one of the few properties of latex first recognized and widely used for trade and processing, ever since the commencement of commercial exploitation of *Hevea* trees. It has been the basis for incentive payments to tappers who bring in more than the daily agreed poundage of latex. It is an important parameter in rubber and latex processing where the DRC of bulk latex and the amount of chemical additives required for the production of rubber and latex products are determined and quick evaluation of yield for academic purposes. The importance of DRC cannot be over-emphasized^{49,50} when it comes to industries based on latex/rubber processing. Another important aspect of DRC or TSC measurement is the automatic process control in latex based industries. There is need for a DRC sensor for direct interfacing to the computer system for automation of the industrial process⁵¹. The most accurate method for the determination of DRC is by the standard laboratory drying

method that has been subjected to several modifications over the years to reduce the time of estimation, the most prominent being the Chee method^{46,52}.

In spite of its wide usage and reference, misconception and misinterpretation of DRC are common, resulting in many unnecessary disputes and mistrust between buyer and seller in the field. Many factors contribute to this situation. First, there is no analytical method for determining the DRC of latex, which is satisfactory and acceptable to both the buyer and the seller. The existing methods are laborious, lengthy and costly; thus are unsuitable for use in the field, or they are unreliable and not accurate. Second, many are ignorant of the test methods used and their limitations. Suspicion of manipulation by the buyer to measure the DRC to his own advantage comes naturally to the seller. Disputes over test procedures in the field are not uncommon. Third, many are ignorant of the fact that the DRC is a variable property of latex and it varies depending on the season, weather, soil conditions, clone of the trees, stimulation scheme, tapping system etc. Dilution of latex with water or preservatives also alters the DRC. Adulteration of field latex not only results in a 'fake' DRC to be obtained, but also results in processing difficulties in the factory, causing heavy losses to the buyer. Analysis of field latex diluted with rainwater or that in which pre-coagulation has set in, is therefore an extremely difficult task⁵².

Numerous methods have been cited in literature for the measurement of the DRC of latex, of which the hydrometer^{54,55} is probably the most rapid one, even though its accuracy is limited by a wide range of conditions

encountered in practice, which include biodeterioration, adulteration, dilution, aeration and warming. For latex, the average error of the measurement is about 4% of the value estimated by the standard procedure, which compares with the oven dry weight of a sample of rubber coagulated from 10g sample of latex. The 'Spot Method' is popular in many laboratories, which uses an accurate weighing balance to weigh the coagulum from a 0.3 g sample dried on a steam bath oven and expressed as a percentage of the original mass. The measurement time is about 30 minutes, with an error of about 1%⁵³.

Other methods that have been reported for the determination of DRC include direct method⁵⁶, trial coagulation method⁵⁷, nephelometric method⁵⁹, viscosity method⁸⁰, Latex film dialysis⁵⁸, Titration method⁵⁰, Microwave attenuation⁵⁹, Low resolution pulsed NMR technique⁶⁰, Spin eco- technique⁶⁴ and Dielectric method^{62,101}. The shortcomings of these methods are that they are either labour intensive, time consuming, difficult to use or expensive.

1.5: Techniques to determine DRC of latex: An overview

1.5.1: The standard laboratory method

The standard test procedure to obtain DRC is based on British Standard⁵⁹. The procedure is based on the Malaysian Standard MS 3:35:1975 entitled Methods of Sampling and Testing Concentrated Natural Rubber Latices, the British Standard BS 1672:1972 entitled "Methods for Testing Natural Rubber Latices, the American Society for Testing and Materials,

ASTM D 1076:77 entitled 'Rubber – Concentrated, Ammonia Preserved, Creamed and Centrifuged Natural Latex' and the International Standard ISO 126-1972 (E)⁴⁶. The general procedure in the laboratory is to coagulate a known weight of representative sample of the latex with dilute acetic acid, sheet the coagulum and dry it at about 75⁰C in an oven. The DRC of the latex is therefore the percentage by weight of the dry sheet over the weight of latex tested⁶⁴. This method, however, has its limitations and is not suitable for field use because of the following reasons⁴⁶.

- (1) Establishment of a laboratory equipped with an analytical balance, electric oven and water bath cannot operate in the field where there is not even electricity.
- (2) It requires a heavy capital investment for the establishment of electricity and equipment and is beyond the ability of small holders and many small establishments.
- (3) The other drawback of this method is that it requires a skilled operator to operate and maintain the laboratory equipment.
- (4) In this method test results cannot be obtained on the day of testing because test samples are required to dry in the oven overnight.
- (5) Payments cannot be made to the tappers on the day of tapping due to the reason cited as (4) above.
- (6) The whole operation of test takes more than 16 hours and cannot be performed in the presence of the tappers, and so the tappers need not accept the test method adopted.

1.5.2: The hydrometer method

The use of hydrometers to evaluate the DRC in latex appears to have begun with Eaton's publications^{65,66}. Hydrometers, usually known at rubber plantations by the names, *Metrolac*, *Latexometer* or *Simplexometer*, are commonly used as the easiest method of obtaining an approximate estimate of the dry rubber content of latex⁶⁷ and this has been reviewed by many researchers⁶⁸⁻⁷⁵.

Metrolac, an instrument, which uses the density difference of rubber and water, is used for quick DRC measurement in estates. One part of well-stirred field latex is mixed with two parts of water. The diluted latex is filled in a tall cylindrical jar with a diameter of around 7.5 cm. Air bubbles and froth remaining on the latex surface are removed by blowing off the surface. The Metrolac, after washing in water, is immersed in the latex and allowed to come to rest without touching the side of the cylinder. The reading on stem is noted. The DRC of the latex is obtained by multiplying the reading by three (since two parts of water are added) and dividing by ten. The method, though quick, simple and easy, is not very accurate. The error is in the range of 5 to 10 percent. However, this method is still in use in rubber estates for assessing the DRC of latex for making sheets on a large scale and also for calculating the quantity of rubber brought in by a tapper. In order to minimize the error, a correction factor is applied based on the actual laboratory estimation of the DRC of bulk latex⁷⁶.

The measurement errors, while using the Metrolac, are due to the following reasons. Firstly, the density of the rubber particles in latex is not precisely known, it varies with what we choose to define rubber. Available evidence indicates that the density of purified rubber at 29°C is about 0.902 to 0.9035. Further, observations⁷⁷ on normal latex and on purified centrifugal concentrates⁷⁸, both suggest that density of rubber may increase with decreasing DRC of the parent latex, presumably due to adsorption of more serum solids. In both the investigations, however, the density of the rubber phase is estimated indirectly. No reliable data is available showing correlation of densities of normally prepared rubbers with the DRCs of the latices from which they are coagulated. It should be recognized that this is to be taken only as an empirical value for this purpose in hand, and not as an unbiased estimate of the true density of rubber.

Secondly, the serum in latex is not a single substance like water, but is a solution of mixed ingredients, proteins and salts; and unfortunately there is no satisfactory evidence to show how its density varies between different estates, clones, season etc. However, available evidence suggests that serum density is not directly correlated to DRC of latex^{79,80}.

1.5.3: The Latex film dialysis

This method is based on the customary 'total solids' determination procedure. The principle of coagulation dialysis experiments⁸⁵ is with an aim to replace washing and rolling operation. In previous methods^{90, 91} the

coagulum was not passed between rolls, but mechanical treatment is not omitted. Besides, drying is carried out at 70⁰C; the handling of coagulum differs from the latex film dialysis method. In latex film dialysis method, sample is prepared by adding up to 4 ml of 20% w/v ammonium chloride solution in to a petri dish of 8.5 cm internal diameter. In the case of fresh ammoniated field latex and fresh unammoniated field latex, 5 ml and 3 ml respectively of 2% w/v formic acid solutions are used. About 3 grams of concentrate or 5 grams of field latex – weighed to the third decimal - are slowly added, while swirling the dish constantly. The mixture is spread as uniformly as possible over the whole bottom of the dish, coagulating in to a well formed film. Heating in a vented air oven at 100-105⁰ C for about 15 minutes accelerates the coagulation, completion of which is indicated by the appearance of a clear serum. The film is further fixed between two pieces of small glass triangle, and then left submerged at the bottom of a basin (for 60 minutes if the ammonium chloride coagulant is employed, or for 30 minutes if the formic acid coagulant is applied). The basin is continuously filled with clean, running water (only in case of emergency, it could be periodically filled). Thereafter, the film is drawn out of the water, and its surface moisture is removed by blotting with a clean cloth or filter paper. Subsequently it is dried at 100-105 ⁰C for approximately 2 hours in the drying oven, cooled to room temperature in a desiccator, weighed and the DRC determined⁵⁶.

1.5.4: The microwave technique

The parameter of related to nonmagnetic materials which describes their interaction with an electromagnetic field, is the permittivity $\epsilon = \epsilon' - j \epsilon''$, where ϵ' is the dielectric constant and the imaginary part ϵ'' is the loss factor. The permittivity is a measure of the polarization in an applied electromagnetic field. As the frequency of the applied field increases, the molecules are unable to re-orient completely before the field reverses. At these frequencies, the orientation of permanent dipoles no longer contributes to the dielectric constant and it is dissipated as heat. Physically, the dielectric constant represents the ability of a material to store electric energy while dielectric loss represents the loss of electric field energy in the material.

The principle of microwave technique is based on the fact that the permittivity of water is much higher than that of solid substances in the latex. At room temperature and at microwave frequency 10.7 GHz, the value of permittivity of water is $\epsilon_w = 60 - j 34$, while the permittivity of solid material is about $\epsilon_s = 2.3 - j 0.02$. This means that the absorption coefficient of microwaves due to water is higher than that due to solid substances. Therefore, the higher is the water content, the higher is the attenuation of microwaves. So microwave absorption technique can be used to determine TSC and DRC of Hevea latex. However, non rubber substances in latex samples vary with clone, soil condition, season, weather etc. Therefore, the accuracy of low power microwave technique is affected by variations in non rubber substances.

1.5.5: The specific heat method

The 'method of mixtures' measures the initial masses and temperatures of a quantity of latex or crepe and hot or cold water with which the latex is to be mixed, and final temperature after mixing in a pre - calibrated vessel. The specific heat of the latex or crepe is then computed, after allowing for the heat absorbed by the flask. It is necessary before the determination of specific heat of any sample, to determine the quantity of heat that will be absorbed by the material of the flask, on the assumption that hot water is to be mixed with the sample. Once the flask constant, K , or heat gain factor has been determined by heat balance using water as calories per degree Centigrade temperature rise, the specific heat S_R of dry rubber samples can be readily obtained by similar heat balances using dry rubber samples and hot water. Having determined K and S_R , the specific heat and DRC of wet samples or latex can then be obtained by mixing hot water and appropriate heat balances.

The dry rubber content of NR latex or wet crepe was found to be a linear function of specific heat. Measurement of DRC using specific heat method is fairly accurate with a standard deviation of 0.7% for latex and 1% for wet crepe. Operation time for specific heat method is about 7 minutes and about 11 minutes for latex and crepe respectively. The results indicate that the technique can be utilized for rapid measurement of DRC in the laboratory⁵³. However skilled man power is necessary for the measurement.

1.5.6: The low resolution NMR technique

The basic theory of NMR⁹²⁻⁹⁵ and the determination of the solid contents of rubber latex by means of pulsed NMR⁹⁹ spectrometer using Bruker Minispec spectrometer have been described in cited literature. A brief description of the method of pulsed NMR necessary to understand its use in this technique is given here. When a sample containing nuclei with non-zero spin (I) is placed in a static magnetic field (H_0), majority of nuclei are aligned and precess around the magnetic field with a characteristic frequency (ω_0), which is related to H_0 by the well known Larmour equation $\omega_0 = \gamma H_0$ where γ is the gyro magnetic ratio. The interaction between nuclear magnetic moments and H_0 results in macroscopic magnetization $M(t)$ growing exponentially to its maximum value M_0 with time constant τ_1 called spin relaxation time. The radio frequency magnetic field designated as H_1 applied at resonance frequency and at right angles to H_0 flips the magnetization away from its equilibrium direction (Z-axis). The flip angle (α) is given by $\gamma H_1 t_w$; where t_w is the time for which the RF field is applied. When the RF field is applied for such a duration that $\alpha = 90^\circ$, it is called 90 or $\pi/2$ pulse and if the RF field is applied for a duration that $\alpha = 180^\circ$ (i.e. – Z direction, it is called 180° or π pulse).

The application of a 90° pulse flips the magnetization in a plane perpendicular to the Z-axis resulting in induction of voltage in the detector coil – called the NMR signal which is proportional to the number of nuclei under study e.g. ^1H present in the sample. After the pulse, the signal decays with

time and precesses freely without the influence of any field and is called free induction decay (FID). The signal in a perfectly homogeneous magnetic field decays due to natural spin – spin interactions exponentially with a time constant T_2 called transverse relaxation time or spin – spin relaxation time. However, in actual practice, decay of the signal become faster due to inhomogeneity of the magnetic field and signal decays instead with time constant τ_2^* given by: $1 / \tau_2^* = 1/T_2^s + 1/T_2^f = 1/T_2^s + \gamma\Delta H_0/2$ where T_2^s is the T_2 of the sample, T_2^f is that due to field and ΔH_0 is the inhomogeneity of the magnetic field. T_2^f is < 1 ms for a typical low resolution spectrometer. In fact for most of the liquid samples, T_2^* is primarily governed by field inhomogeneity.

The contribution of inhomogeneity in H_0 to the free induction decay can be eliminated by a well known sequence called spin – echo⁹². The method consists of the application of a 90° pulse followed by 180° pulse after a time interval ζ and observation of a free induction echo formed at time 2ζ . The effect of 180° pulse is to re-phase the spins de-phased due to inhomogeneity of the magnetic field. The echo signal decays exponentially with time constant T_2 (neglecting small diffusion effect).

Rubber latex consists of a solid phase of which nearly 97 % is rubber, and an aqueous phase. The pulsed NMR can distinguish between the proton signals from solid and liquid phases of the sample based on their differences in T_2 ; T_2 of solid is much smaller than that of Liquid⁹². The combined signal by both solid and liquid phases measured at $24 \mu\text{s}$ (immediately after the dead

time of the receiver) following a 90° representing the liquid phase is measured at 6 ms when the signal due to the solid component has decayed almost completely. The signal of rubber phase 'S' is obtained by subtracting 'L' from the signal measured at 24 μs. The DRC is determined using the equation:

$$DRC (\%) = 100 \times F.S / (F.S+L) \quad \dots\dots 1.1$$

Where 'F' is the ratio of hydrogen content of the aqueous phase (assumed close to that of water) and of rubber.

1.5.7: The titration method

In NR latex, the rubber particles have on their surface an adsorbed layer of proteins and other ions that are negatively charged. The quantity of adsorbed anions in turn depends on the size and number of particles present in unit volume of latex and hence on the DRC of the latex. Since coagulation is a process in which adsorbed anions formed from different sources in latex are neutralized by a coagulant, there can be a relation between adsorbed anions and amount of coagulant utilized for coagulation. If latex can be coagulated immediately, then a correlation can be found between the dry rubber content and the amount of coagulant required for coagulation. Normally, fresh latex coagulation is a slow process and hence it has to be sensitized for quick coagulation. It has been reported that latex containing fatty acid soaps and other surfactants gets coagulated very fast by addition of

acids^{79,80}. When fatty acid soaps are added to latex, the fatty acid anions cause displacement of protein molecules and get strongly adsorbed on rubber particles. In this way the protein – stabilized latex gets transformed into soap – stabilized system⁸¹. When acid is added to soap treated latex the adsorbed soap anions react with acid to form undissociated fatty acid, thus depriving the latex particles of stabilizers. As a consequence, latex coagulates immediately⁸². Assuming uniform size and spherical shape for rubber particles in latex, the number of particles present in unit volume of latex (N) and volume fraction of the dispersed polymer (ϕ) are related by the equation⁸³.

$$N = 6\phi/\pi x^3 \quad \dots\dots 1.2$$

where x is the diameter of the particles, ϕ is a parameter related to DRC and N is proportional to the quantity of soap adsorbed. The above two assumptions are not fully true for NR latex particles. Even though there is variation in particle size, it is reported⁸⁴ that latices of different clones and different age groups have maximum number of particles with size in the range of 1 μm . Similarly the shape of rubber particles may vary but the majority are of spherical shape. Considering these factors, Equation (1.1) can become valid for fresh NR latex. As DRC of latex increases, the total adsorbed soap increases and the acid required to coagulate latex also increases. Thus, from the volume of acid required for coagulation of latex, it is possible to determine the DRC of latex.

1.5.8: The dielectric method

An elementary parallel plate capacitor consists of two conducting plates, electrically isolated from one another by an insulating medium. The capacitance (C) of this elementary capacitor is proportional to (i) the cross-sectional area A of the plates, (ii) the permittivity (or dielectric constant K) of the insulating medium and (iii) the reciprocal of the separation, t, between the plates. The relation is given by¹⁰²

$$C = \frac{KA}{t} \quad \dots 1.3$$

If the area of the plates and the separation between them are kept constant, the capacitance of the capacitor is directly proportional to the dielectric constant or permittivity of the medium. If there is a direct relation between the DRC and dielectric constant of latex, then the same relationship holds good for the capacitance and DRC of rubber latex, if used as the dielectric. Hence it is possible to calculate the DRC of latex by measuring the capacitance of latex using capacitive techniques.

1.6: Shortcomings of the existing methods

Rapid determination of DRC is very important for commercial exchange of natural rubber latex and for making various decisions related to products manufacturing. Ever since the commencement of commercial exploitation of natural rubber trees, hunt for a viable and quick method for

determination of DRC had prominence. The Malaysian Rubber Board, in the year 1983, took an initiative to create awareness among researchers across the globe by announcing competition to honor an inventor who could design and develop a reliable and quick electronic DRC measurement system with reasonable accuracy. Though there were 83 entries to the competition, none of them could win the prize. A consolation prize was then awarded to the inventors of DRC measurement techniques based on microwave attenuation and turbidity. The main drawbacks of these systems were that they could not be used in the field, have limited accuracy, and are expensive. Due to these limitations these have not gained much popularity among the stakeholders in the rubber industry. The technique based on low pulsed NMR and spin-echo techniques are also reported for DRC measurement. The major shortcomings of these techniques are that they are not accurate and are very expensive, involving heavy capital investment and can be used only under standard laboratory conditions by a specialist.

The Metrolac or hydrometer method is the most widely used one for rapid determination of DRC. The main limitation of this method is that it measures the DRC with an error up to 11 % and hence only an approximate value can be obtained. The hydrometer method is widely used for getting an approximate value of the DRC.

The most accurate method having international recognition is the standard laboratory method (gravimetric method). However, the main limitations of this method are that it is time consuming, labour intensive,

unsuitable for use in the field, not environment friendly, requires skilled manpower and involves heavy capital investment for setting up chemical/instrumentation laboratory for handling the test samples.

Many researchers also have reported laboratory methods such as latex film dialysis, specific heat and titration methods for DRC determination. Though they could determine the DRC within reasonable time, they are not very accurate, are labour intensive, cannot be used in the field, require capital investment and skilled labour.

The main disadvantage of the dielectric method is that the system often shows erratic readings owing to the presence of adulterants and due to ionic activity in the latex.

1.7: Outline of the work presented in this thesis

In this thesis, results of our work on the design and development of different instrumentation systems for the rapid determination of Dry Rubber Content in natural rubber latex are reported. We have developed five different techniques to measure DRC of latex. These are based on the Fourier Transform Infrared Spectroscopy, Thermo Gravimetric Analysis (TGA), Capacitance measurement, Near Infrared Spectroscopy (NIRS) and Differential Scanning Calorimetry. The thesis is presented in six chapters. In the first chapter we have briefly discussed the history of natural rubber, its chemical as well as physiological properties, existing techniques used for

DRC estimation and their shortcomings. We have carried out IR absorption studies using Fourier Transform Infrared Spectroscopy (FTIR) spectroscopy and thermal properties by employing the Thermo Gravimetric Analysis (TGA) of natural rubber latex. We could see that the normalized differential transmittance around 835 cm^{-1} in the MIR spectra exhibit a good relation with DRC values. In TGA analysis we have observed that the mass normalized percentage weight loss between room temperature and 100°C (at a definite heating rate) exhibit a good correlation with corresponding DRC values. The experimental set up, results obtained and discussion in each case are included in *chapter Two*. A capacitive transducer was designed and fabricated to study the change in capacitance of latex samples with their DRC values. It is observed that the change in capacitance values with DRC for different latex samples exhibit a good relation. The principle of the capacitance method, constructional details of the capacitive transducer, experimental set up, results and discussion are included in *chapter three*. We have carried out NIR reflectance studies on various latex samples with an internal diffuse reflectance attachment in a UV-Vis-NIR Spectrophotometer. We have noticed that the NIR reflectance (or inverse absorption) of latex samples exhibit a minimum (or peak in absorption) at 1460 nm due to the molecular vibrations of water molecules present in the latex. The change in reflectance at this particular wavelength is proportional the DRC of the latex samples. The principle of the method, the experimental set up, results and discussion are included in *chapter four*. We have also carried out systematic measurement of

the mass normalized change in enthalpy of a series of rubber latex samples at a definite heating rate using a Differential Scanning Calorimeter and found that there is a direct correlation between the DRC values and the enthalpy change over a defined temperature change. The experimental method, results obtained and a discussion of the results are included in *chapter five* of this thesis. Finally, in *chapter six* the summary and general conclusions of the work including scope for doing further work in the area are incorporated.

References

1. Markham, C.R., *Journal of the Society of Arts* (1876) 475-482.
2. Petch, T., *Annals of the Royal Botanic Gardens Peradeniya* (1914) **5**: 440-487.
3. Hofmann, W., *Rubber Technology Handbook* Hanser Publishers, Munich, Germany. (1989) 2.
4. *Rubber & Plastics News*, (1984) **14**: 2, 21.
5. ASTM D 1566-98, Standard Terminology Relating to Rubber.
6. Suzuki, D., *The tree that changed the World* (videotape). Canadian Broadcasting Corporation, Ottawa, Canada.
7. Anon., *Travancore Almanac* (1871) 123-136.
8. Baak, P.E., *Planters Economic and Political Weekly* (1992) **27** (33): 1747-1753.
9. Lalithakumari and Jom Jacob., *Natural rubber industry in India: An overview*. In: *Natural Rubber: Agro management and Crop Processing*, Rubber Research Institute of India, Kottayam. (2000) **23**: 583- 598.
10. George, K.T. and Thomas, K.K., *Five decades of Rubber Board and the Indian rubber industry: An assessment in retrospect*. Rubber Board, Kottayam. (1997) 38.
11. Kurian K. Thomas and Panikkar, A.O.N., *Natural Rubber: Agro management and Crop Processing*, Rubber Research Institute of India. (2000) 1-17.

12. Faraday, M., *Quart. Journal of Science and Arts.* (1826) **21**: 19.
13. Usha Nair, N., *Natural Rubber: Agro management and Crop Processing.* Rubber Research Institute of India, Kottayam. (2000) **14**: 249- 260.
14. Southorn, W.A. and Yip, E., *Journal of the Rubber Research Institute of Malaya.* (1968) **20(4)**:201-215.
15. Low, F.C., *Journal of the Rubber Research Institute of Malaysia.* (1978) **26(1)**: 21-32.
16. Archer, B.L., Audley, B.G. and Bealing, F.J., *Journal of Rubber Research Institute of Malaya.* (1982) **21 (4)**: 560-569.
17. Hahn, A.M., Hermann, J. Marianti. Mariano, A and Walujeno, K., *Communications of the Research Institute for Estate Crops.* (1971) **1**.
18. Bowler, W.W., Electrophoretic mobility of fresh *Hevea* latex. *Industrial Engineering Chemistry.* (1953) **45**: 1790.
19. Nair, N.U., Thomas, M., Sreelatha, S., Simon, S.P., Vijaya kumar, K.R., and George, P.J., *Indian journal of Natural Rubber Research.* (1993) **6 (1& 2)**: 143-145.
20. Archer, B.L., Barnard, D., Cockbain, E.G., Dickenson, P.B and McMullen, A.I., *The Chemistry and Physics of rubber Like Substances* (Ed. L. Batteman). Maclaren and Sons Ltd., London. (1963) 41-72.
21. Cook, A.S. and Sekhar, B.C., *Journal of the Rubber Research Institute of Malaya.* (1953) **14 (286)**: 163-168.

22. Archer, B.L., Audley, B.G., Mcsweeney, G.P. and Hong, T.C., *Journal of the Rubber Research Institute of Malaya*. (1969) **21(4)**: 560-569.
23. Southorn, W.A. and Yip, E., *Journal of the Rubber Research Institute of Malaya*. (1968) **20(4)**:201-215.
24. Williams, C. G., *Phil. Trans.* (1860) 241; *Proc. Soc.* (1860) **10**: 516 and *J. Chem. Soc.* (1862) **15**, 110.
25. Tata, S.J. and Yip, E., *Rubber Research Institute of Malaya*, Kuala Lumpur. (1968) Research Archive No.59.
26. Dickenson, P.B., *Proceedings of the Natural Rubber Producers' Research Association jubilee Conference*. (1964) 52-66.
27. Archer, B.L., *Proceedings of the Natural Rubber Producers' Research Association Jubilee Conference*, Cambridge, London. (1964) 101-112.
28. Sarath Kumara, P.H., *Handbook of Rubber: Processing* (2003) 1-13.
29. Bowler, W.W., Electrophoretic mobility of fresh Hevea latex. *Industrial Engineering Chemistry* (1953) 45: 1790.
30. Bouchardat, G., *Bulletin Society Chemistry*. (1875) **24**:105.
31. Leynen, F., *Journal of Rubber Research Institute of Malaya*. (1969) **21(4)**:389-406.
32. Bonner, J., *Journal of Chemical Education*. (1949) **26**: 628.
33. Arreguin, B., Bonner, J. and Wood, B.J., *Archives Biochemistry and Biophysics*. (1951) **31(2)**: 417- 444.
34. Bandurski, R.S. and Teas, H., *J. Plant Physiology*. (1957) **32 (6)**: 643.

35. Park, R.B. and Bonner, J., *Journal of Biological Chemistry* (1956) 233 (2): 340-343.
36. Lynen, F., Agranoff, B.W., Eggerer, H., Henning, U. and Moslein, E.M., *Angewandte Chemie*. (1959) **71**: 657.
37. Archer, B.L., Audley, B.G., Cockbain, E.G. and Mcsweeney, G.P., *Biochemical Journal*. (1963) **89**: 565-574.
38. McMullen, A.I. and Mcsweeney, G.P., *Biochemical Journal*. (1966) **101**: 41.
39. Archer, B.L., Audley, B.G., *Advances in Enzymology*. (1967) **29**: 221-257.
40. Archer, B.L. and Cockbain, E.G., *Methods in Enzymology*. (1969) **15**: 476-480.
41. Madhavan, S. and Benedict, C.R., *Plant Physiology*. (1984) **75**: 908-913.
42. Schulz, G.V. and Mula, A., *Proceedings of the Natural Rubber Research Conference, Kuala Lumpur, Malaysia*. (1960). 602-610.
43. Bunn, C.W., *Proceedings of the Royal Society*. (1942) **180** (980): 40.
44. Golub, M.A., Fuqua, S.A. and Bhacca, N.S., *Journal of American Chemical Society*. (1962) **84** (2): 4981.
45. Naunton, W.J.S., *Text book on The Applied Science of Rubber*. (1961) 5.
46. Rubber Research Institute of Malaysia, *Plrs" Bull.* (1973) **124**: 4-13.
47. Chin, H.C., *RRIM Training Manual on Analytical Chemistry*. (1979) 63.

48. Kuriakose, B., *Natural Rubber: Biology, Cultivation and Technology*. (1992) 370-398.
49. Rubber Research Institute of Malaysia, *Plrs" Bull.* (1980) **163**: 4-13.
50. Rosamma Alex, Premalatha, C.K., Baby Kuriakose and Ramesh B. Nair, *J.Rubb.Res. of Malaysia*. (2003) **6 (4)**: 221-230.
51. Kaida, K., Determination of Dry Rubber Content of Hevea Latex by Microwave Technique. *Petanika*. (1982) **5(2)**:192.
52. Chin Hong Cheaw., *Plrs" Bull. Rubb. Res. Inst. Malaysia*. (1981), **169**: 136-149.
53. Harris E.M., *Proc. Inter. Rubb. Conf*, Kuala Lumpur, Malaysia. (1985) 271-285.
54. Nadarajah, M. and Muthukuda, S., *Quart. J.Rubb.Res.Inst.Ceylon*. (1963) **39** : 85-93.
55. Nair, K.K and Sivaramakrishnan, N. H., *Rubber Board Bulletin*. (1970-71) **11(1)**:17-24.
56. Whiteby G Stafford, *Plantation rubber and the testing of rubber*. (1920) 135-138.
57. Whiteby G Stafford.,*Plantation rubber and the testing of rubber*. (1920) 138.
58. Sumarno Kartowardojo, *J.Rubb.Res.Inst.Malaysia*. (1969) **22(4)**, 389-398.
59. Kaida Bin Khalid, Yahya Mat Hassan and Abd Rahman Ramali, *Proc. RRIM Growers Conference*, Malacca. (1989) 493-504.

60. Gambhir, P.N., Joshi, D.K., Tiwari, P.N. and Mani, J. *Journal of Natural Rubber Research*. (1993) **8(3)**: 208-212.
61. Gambhir, P.N., Joshi, D.K., Tiwari, P.N. and Mani, J. *13th International Conference on magnetic resonance in biological systems*. (1993).
62. Kaida Bin Khalid and Mohammad Daud, *J. Rubb. Res. Inst. of Malaysia*. (1994) **7 (4)**: 281-289.
63. British Standard, *British Standard methods of testing Natural Rubber Latices BAS167*, (1972) 8.
64. Chin, H.C. and Mohinder Singth, *Manual of Laboratory Methods of Testing Hevea Latex*, Rubber Research Institute of Malaysia, Kuala Lumpur. (1971) 10-14.
65. Eaton, B., *F.M.S Department Agricultural bulletin*. (1912) 17.
66. Eaton, B., *Agricultural bulletin of F.M.S Department*, (1914) **2**:225-230 and 314 -322.
67. Smith, H Fairfield, Specific Gravity of Latex and of Rubber, *J. Rubb. Res. of Malaysia*, (1940) 218.
68. Smith, H. Fairfield, *Journal of Rubber Research Institute of Malaysia*. (1940) **9**:218-124 (Communication, 214).
69. Smith, H. Fairfield, *Journal of Rubber Research Institute of Malaysia*. (1947) **12**:47-61 (Communication, 263).
70. Ridson, E.J., *Determination of the dry rubber content of natural rubber latex. Part III – Methods for fresh latex with special reverence to the*

- metrolac*. Rubber Research Institute of Ceylon quarterly Circular. (1955) **31**: 34-50.
71. O' Brien, T.E.H. Glass Hydrometer for latex. Rubber Research Institute of Ceylon, *Second quarterly circular*. (1924) 3-5.
72. Van Der Bie, G.J., *Chronica Naturac*. (1947) **103**: 36.
73. Sarath Kumara, P.H. and Warnajith Pradad, A.K.D., *Bulletin of the Rubber Research Institute of Sri Lanka*. (2006) **47**: 51-58.
74. Sarath Kumara, P.H., *International Natural Rubber Conference*. (2006) 453-460.
75. Leelamma Varghese, Radhakrishnan Nair, N. and Kumaran, M.G., *Agro management and crop processing*, Rubber Research Institute of India. (2000) 377-385.
76. De Vries, O., *Rubber Cultivation*. (1919) **3**: 183 - 206.
77. Van Gils, G.E. Arch, *Rubber Cultivation*. (1939) **23**: 130 -139.
78. Rhodes, E., *Journal of Rubber Research Institute of Malaysia*. (1934) **5**: 243-250.
79. Rhodes, E., *Journal of Rubber Research Institute of Malaysia*. (1939) **9**: 126-141.
80. John, C.K. and Newsam, A., *Plrs. Bull. Rubb. Res. Inst. Malaya*, (1969) **105**: 289-293.
81. John, C.K., *J. Rubb. Res. Inst. Malaya*. (1971) **23(2)**: 147-156.
82. Van Gils, G.E., *Trans. Inst. Rubber Ind.* (1947) **23**: 74-76.

83. Khoo, T.C., Ong, C.O. and Abdul Rahman Rais, *Proc. RRIM Rubb. Growers' Conf. Malaysia*. (1991) 495-510.
84. Blackley, D.C., *Polymer Latices: Science and Technology* Chapman and Hall Publishers, London. (1997) 1: 35-38.
85. Saovanee Kovuttikulrangsie and Yasuyuki Tanaka, *J. Rubb. Res.* (1999) 2(3): 150-159.
86. Schoon, Th, G.F., *Archf Rubber cult. Extra No.2*. (1953) 228.
87. Van Rossem, A. *Colloid Chemistry*. The Chemical Catalog Company Inc, New York. (1932) 4: 235.
88. Schoon, Th, G.F., *Archf Rubber cult. Extra No.2*. (1953) 1.
89. Jirgensons, B and Straumanis, M.E., *A Short Textbook of Colloid Chemistry, 303 and 307*. John Wiley and sons Inc, New York. (1956).
90. Piddlesden, J.H., *J. Rubb. Res. Inst. Malaya*. (1937) 7:117.
91. Van Gils, G.E., *Archf Rubbercult.* (1940) 24: 74.
92. Compagnon, P.and Et Le Conte, J. *Revue gen. Caoutch.* (1944) 21 (5): 102.
93. Farrar, T.C. and Becker, E.D., *Pulse and Fourier Transform NMR*. New York: Academic Press, (1971)
94. Martin, M.L., Dulpuech, J.J and Martin, G.J., *Practical NMR Spectroscopy*, London. Hyden and Sons Ltd. (1980).
95. Fukushima,E. and Roeder, S.B.W., *Experimental Pulse NMR*, Addison Wesley Publishing Company Inc. (1981).

96. Gadian, D.G., *Nuclear Magnetic Resonance and its Applications to Living systems*. Oxford: Clarendon Press. (1982).
97. Jones, S.A. and Stronks, H.J., Determination of the Solid Content of Rubber Latex by Means of Pulsed NMR Using the Bruke Minispec., pp-100. *Bruke's Minispec. Application Note, 20*.
98. Ang, T.T. and Roberts, J.D., *Plastics and Rubber: Materials and Applications*. (1970) **4**:138.
99. Rubber Research Institute of Malaysia, *Plrs" Bull. Rubb. Res. Inst. Malaysia*. (1974) **130**: 21-29.
100. Reji Kumar, R, Najamul Hussain, S and Philip, J., *J. Rubb. Res. Inst. of Malaysia*. (2007) **10 (1)**: 17-25.
101. Calvert, J.M and Mc Causland, M.A.H., *Text Book of Electronics*, John Wiley & Sons, New York. (1978) 12-19.

CHAPTER TWO

Estimation of Dry Rubber Content in Natural Rubber Latex by FTIR Spectroscopy and TGA Techniques

In this chapter we present the work done on the estimation of DRC in rubber latex using two analytical techniques viz. Fourier Transform Infrared Spectroscopy (FTIR) and Thermo Gravimetric Analysis (TGA) techniques. Details of the experimental methods and the results obtained are presented in the following sections.

2.1: Fourier Transform Infrared Spectroscopy

2.1.1: Introduction

In the mid-infrared (MIR) range, the region in which FTIR typically operates, all organic compounds interact with infrared radiation, yielding compound specific absorption characteristics whose intensity follows the Beer's law¹. The MIR range extending from wave number 4000 cm^{-1} to 400 cm^{-1} provide direct information concerning the specific constituents in the sample, as well as their characteristic molecular structure² and chemical composition^{3,4}. In the region of wave numbers between $4,000\text{ cm}^{-1}$ and $1,500\text{ cm}^{-1}$, in general, there is absorption by various stretching modes of functional

groups of molecules, and the region below $1,500\text{ cm}^{-1}$ is significant for deformation, bending, and ring vibrations and is frequently referred to as the fingerprint region of the spectrum⁴.

Fourier transform infrared (FT-IR) spectroscopy can effectively provide chemical information about the structure and composition of biological materials at the molecular level, expanding the applications of vibrational spectroscopy⁵⁻⁹. This noninvasive, convenient, and rapid technique has been applied to the study of various types of healthy and malignant tissues and is a powerful tool in investigating the biochemistry of cancer¹⁰⁻¹⁵. The technique also has promising potential for detecting cancer at an early stage. FTIR spectroscopy has been successfully used to diagnose multiple kinds of carcinoma, such as stomach, colon, liver, esophagus, lung, gall bladder, breast, and parotid gland¹⁶⁻²⁸.

Originally introduced by Naumann and co-workers²⁹⁻³⁰, FTIR spectroscopy is a fast technique for classification and identification of microorganisms³¹⁻³⁴. Moreover, it is a valuable tool for rapid screening of environmental isolates³⁵. FTIR is a very cost-efficient technique which allows a rapid and simple identification of micro-organisms³³ in several situations.

2.1.2: Principle of the method

In a FTIR instrument, the monochromator and the slits in a conventional instrument are replaced by an interferometer, usually of Michelson type. In the interferometer (Fig. 2.1), a beam of IR radiation is divided into two by means of a beam splitter. A path difference between the beams is introduced

whereupon they are allowed to recombine. In this way, interference between the beams is realized and the intensity of the output beam from the interferometer can be monitored as a function of path difference using an appropriate detector.

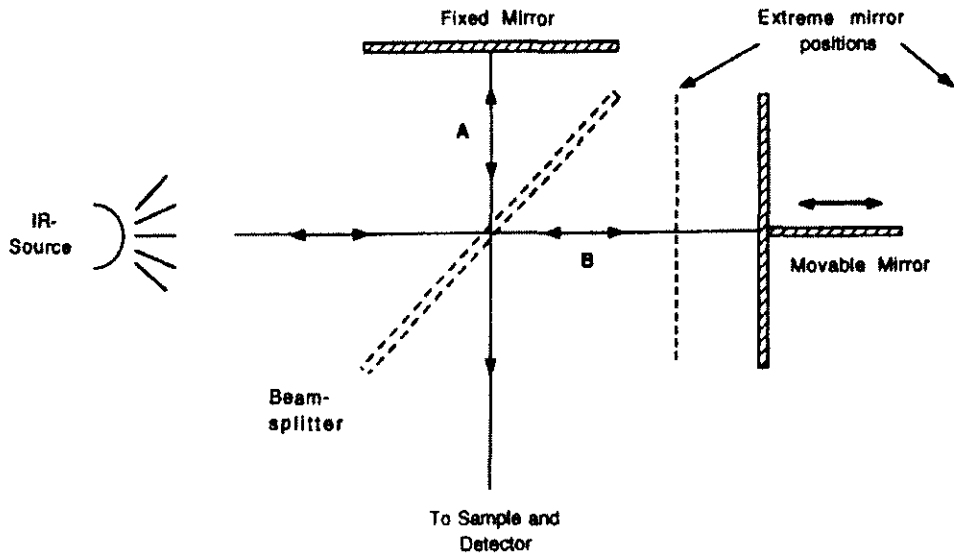

Fig. 2.1: Schematic layout of a Michelson Interferometer.

Mathematically, the signal treatment can be described in the following way. If $I(x)$ is the intensity of the beam measured at the detector at a displacement of the movable mirror by x cm, and if $B(\nu)$ represents the intensity of the source as a function of frequency ν , the equation for the signal at the detector (i.e. the interferogram) can be written as

$$I(x) = B(\nu) \cos 2\pi\nu x \quad \dots\dots 2.1$$

For a dichromatic source (with frequencies ν_1 and ν_2), the signal at the detector is the sum of two cosine waves given by

$$I(x) = B(\nu_1) \cos 2\pi\nu_1 x + B(\nu_2) \cos 2\pi\nu_2 x \quad \dots 2.2$$

For a polychromatic source, as in a real instrument, the detector output, which is the interferogram, is related to the spectrum by

$$I(x) = \frac{1}{2} \pi \int_{-\infty}^{+\infty} B(\nu) \cos 2\pi\nu x d\nu \quad \dots 2.3$$

The spectrum is related to the interferogram by the following relation,

$$B(\nu) = I(x) \int_{-\infty}^{+\infty} \cos 2\pi\nu x dx \quad \dots 2.4$$

Equations 2.3 and 2.4 relate an interferogram signal to an infrared single beam spectrum through Fourier transformation.

2.1.3: Experimental procedure

The analysis of latex samples have been carried out using a Thermo Nicolet Make Avatar 370 FTIR Spectrometer. The quality and reproducibility of the results are ensured through automatic system and accessory recognition. The heart of the instrument is an Enhanced Synchronization Protocol (ESP) technology which brings integration and intelligence in every measurement. Despite its compact size, the instrument offers a full size sample compartment which holds a wide range of accessories required for sample analysis. The system accessory modules of the system provide an unprecedented level of communication with the Nicolet system. Unique

features of the spectrophotometer include permanent alignment of optics for better performance, rugged and enclosed design for optics, automatic recognition for optics and diagnostic checks to ensure optimal performance and check for human errors. Other features of the instrument include quick equilibrium time when an accessory is changed, multimedia tutorials help to use maximum potential, spectral quality checks and suggest improvements for quality FTIR results. The system is loaded with Val Q spectrometer validation package based on the ASTM Standard for FTIR to verify systems performance in compliance with ISO and GLP criteria. The system hardware consists of a base plate, diamond tuned, pinned in place mirrors, pinned and pre aligned Ever Glo Source for easy replacement, interferometer with drive and DSP control, reference He- Ne laser and DTGS detector for signal detection etc. Entire function of the spectrophotometer is controlled using the OMMC software loaded in a stand alone computer. The block diagram of the FTIR instrumentation system is shown in Figure 2.2 and a photograph of the FTIR spectrophotometer is shown in Fig 2.3.

The FTIR spectrum of the latex samples from 2500 cm^{-1} to 500 cm^{-1} is obtained using Attenuated total reflectance (ATR) technique in the transmission mode. Latex sample of volume 2-3 ml spread over a ZnSe crystal is allowed to homogeneously distribute the sample over the crystal. The ATR assembly is loaded in to the instrument and the background spectrum is recorded. The spectrum is reordered for several latex samples.

The latex samples for all the experiments described in this work, were collected from the experimental field of Rubber Research Institute of India, Kottayam, Kerala, India. For the work reported in this paper, latex samples (Clone: RRII 105, Year of planting: 1989-93, D₃ tapping system) with wide variations in DRC were collected. The latex samples were prepared after filtration, 10-15 ml of each sample was collected in separate containers to determine their DRC values following the standard laboratory procedure and another 2-3 ml of latex for FTIR measurements, as outlined above.

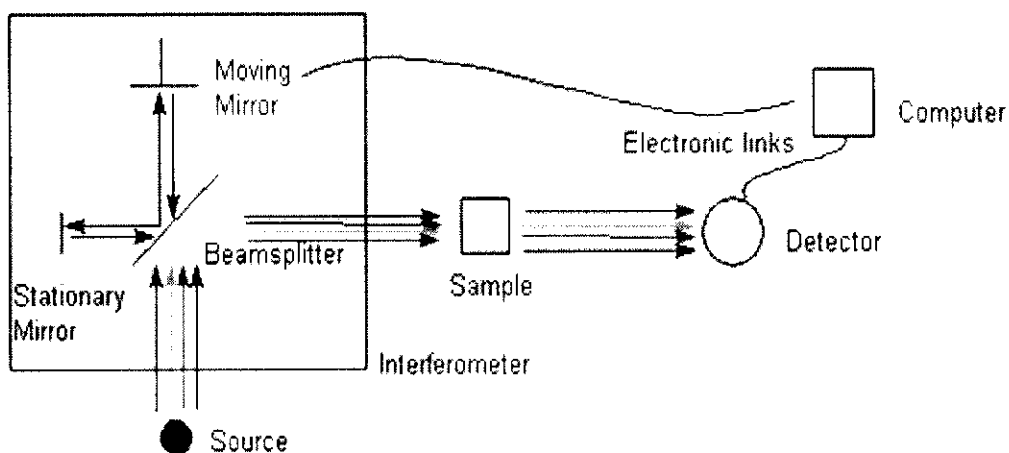

Figure 2.2: Block diagram of a FTIR Spectrophotometer



Figure 2.3: Photograph of FTIR Spectrophotometer

2.1.4: Results and Discussion

Figure 2.4 shows the FTIR absorption spectrum of one sample of natural rubber latex. We can notice a distinct absorption around 835 cm^{-1} , which can be interpreted as due to the absorption by solid rubber (isoprene) molecules. The absorption at 1375 cm^{-1} is due the carbohydrate molecules present in the latex. Such spectra have been recorded for a number of different latex samples. The IR absorption spectra for two representative samples between 1000 cm^{-1} and 650 cm^{-1} are shown in Figures 2.5 and 2.6.

The differences in transmittance between 830 cm^{-1} and 840 cm^{-1} have been determined for each sample. The % DRC values of all these samples have been determined separately following the laboratory drying method. Figure 2.7 shows the variation of % normalized differential transmittance around 835 cm^{-1} with corresponding % DRC values. It can be seen that the normalized differential transmittance between 830cm^{-1} and 840cm^{-1} varies linearly with % DRC with a positive correlation coefficient of 0.91. The sensitivity of normalized differential transmittance to % DRC works out to $0.24\% / \% \text{ DRC}$.

Figure 2.8 shows the transmittance spectra of samples with different DRC values around 1375 cm^{-1} . The % transmittance at 1375 cm^{-1} for different samples have been determined and plotted against the corresponding % DRC values, determined following the laboratory drying method. This variation is shown in fig. 2.9. It can be seen that this variation exhibits a negative correlation of 0.91.

The purpose of this study is to analyze the absorption pattern of latex samples at specific wave numbers in the MIR range, which are the characteristic absorption wave numbers for carbohydrates and natural rubber present in the latex. We could see that the IR absorption is very high at these wavelengths. We assume that the absorption of IR at wave numbers around 835 cm^{-1} is significant for deformation, bending, and ring vibrational modes of rubber molecules, a monomer of isoprene, present in the latex.

Figure 2.4: FTIR absorption spectrum of one sample of natural rubber latex.

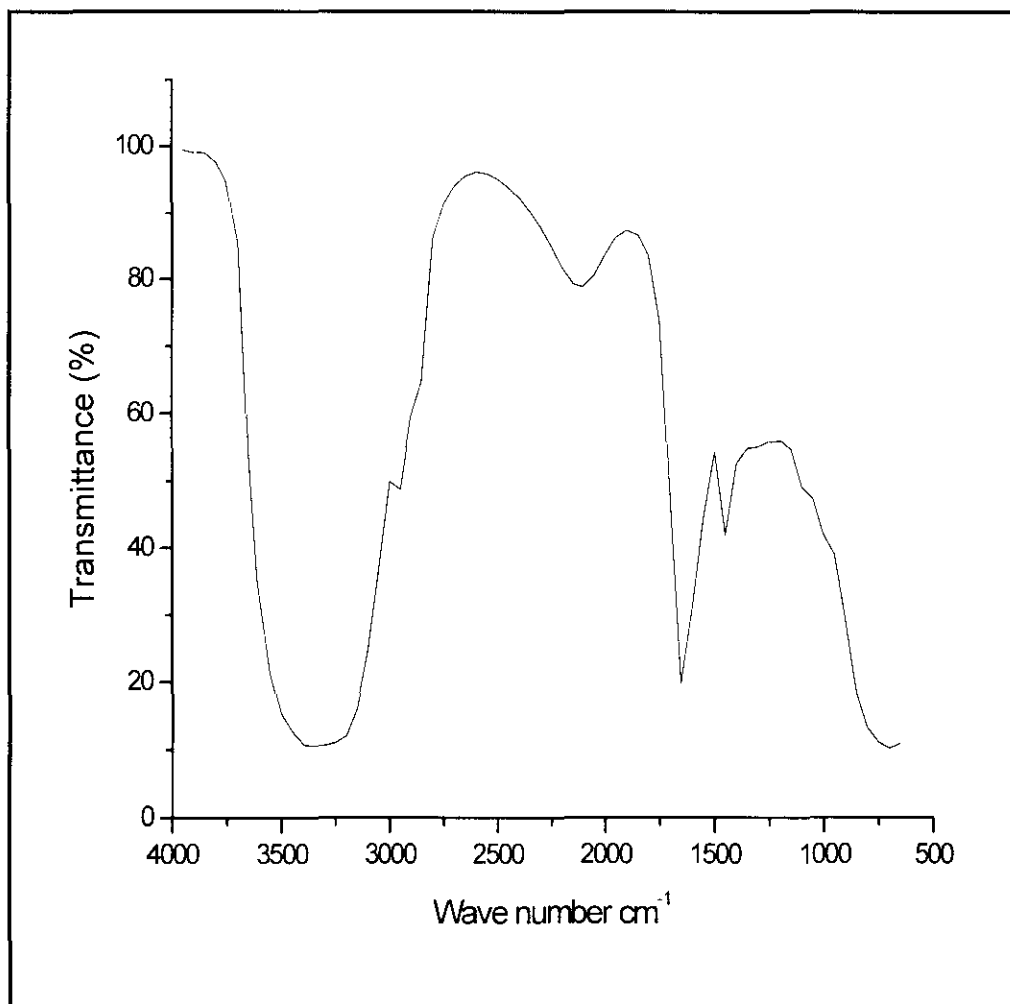

Figure 2.5: Variation of % transmittance around wave number between 1000 cm^{-1} and 650 cm^{-1} with % DRC of latex.

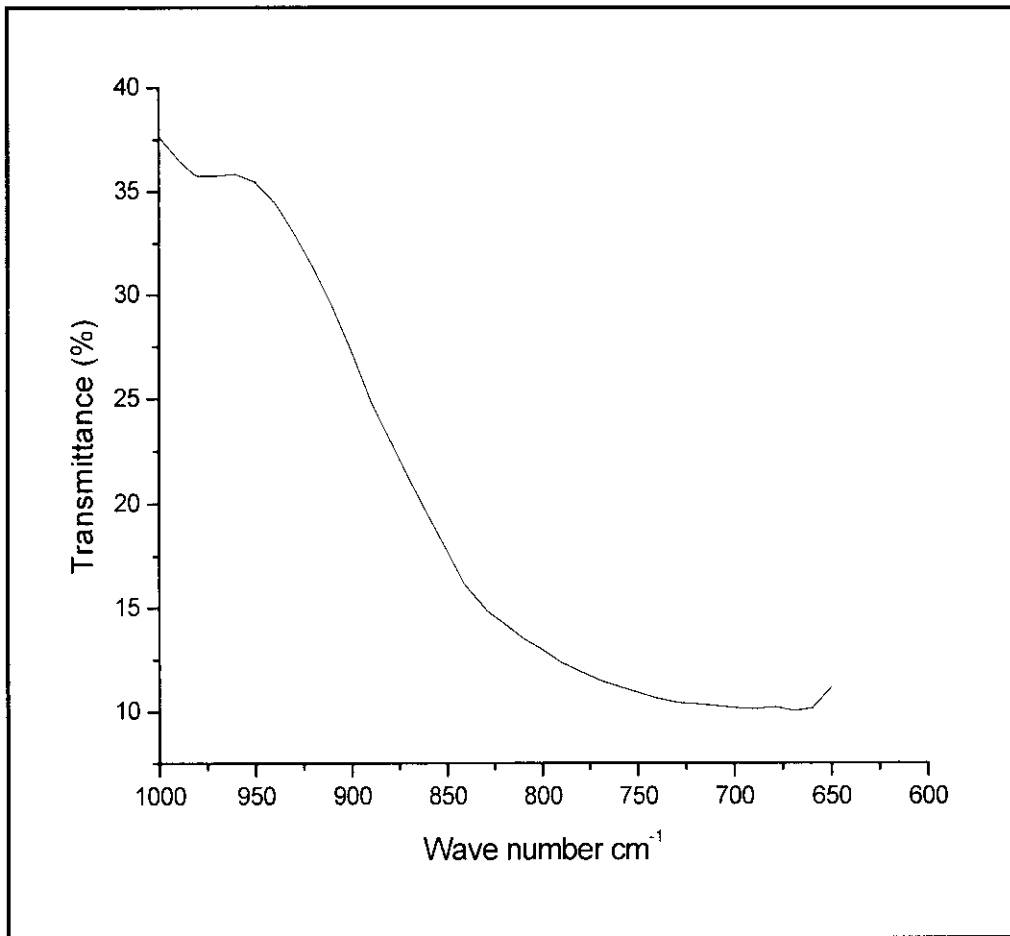

Figure 2.6: Variation of % transmittance around wave number between 1000 cm^{-1} and 650 cm^{-1} with % DRC of latex.

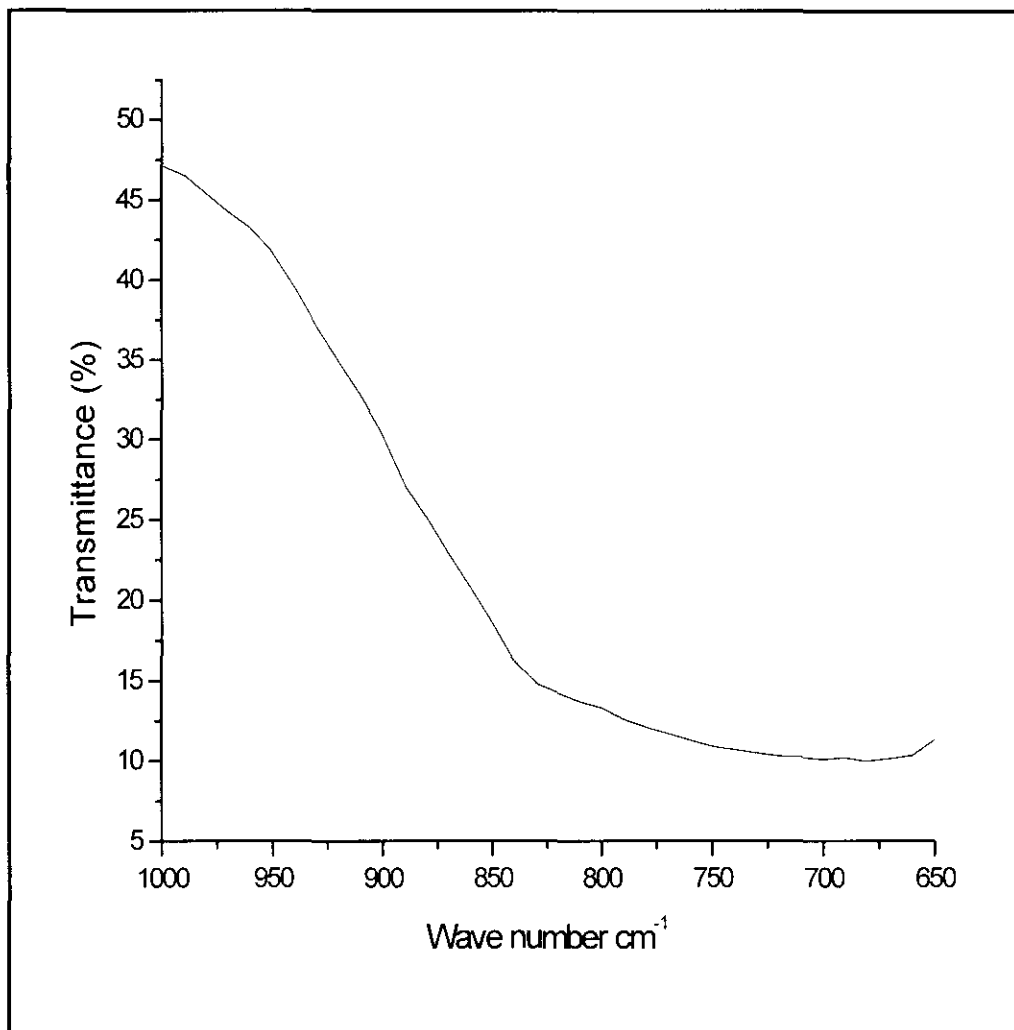

Figure 2.7: Variation of %normalized differential transmittance around wave number 835 cm^{-1} with % DRC of latex.

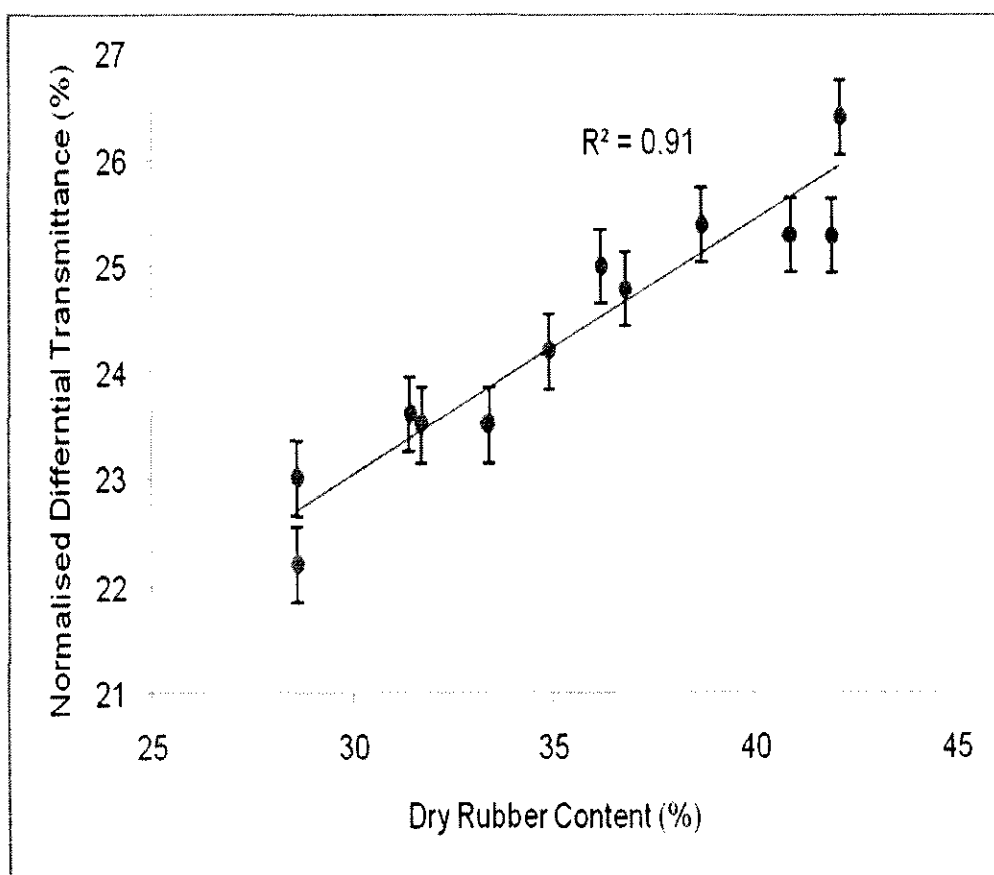

Figure 2.8: Transmittance spectra of different samples (with different % DRC values around 1375 cm^{-1}).

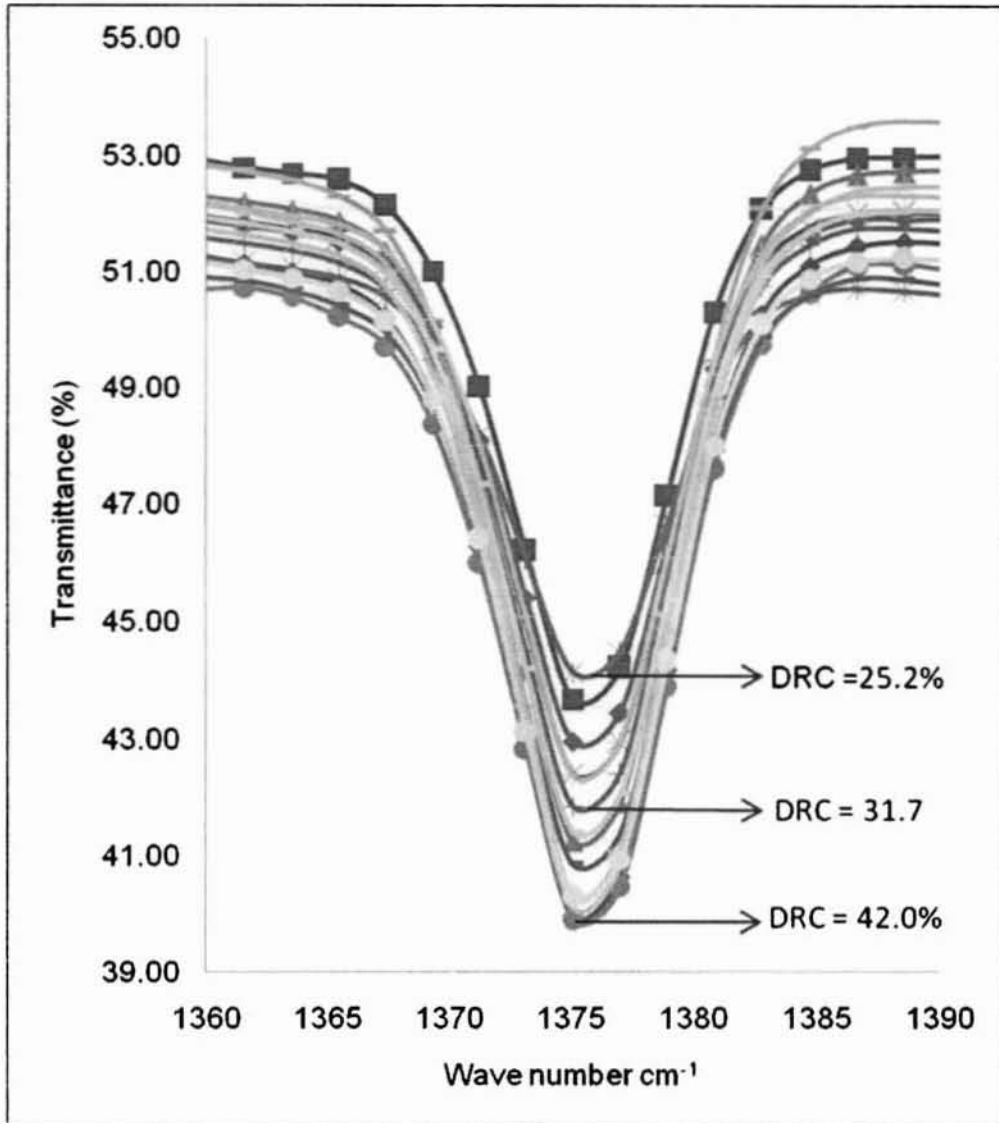
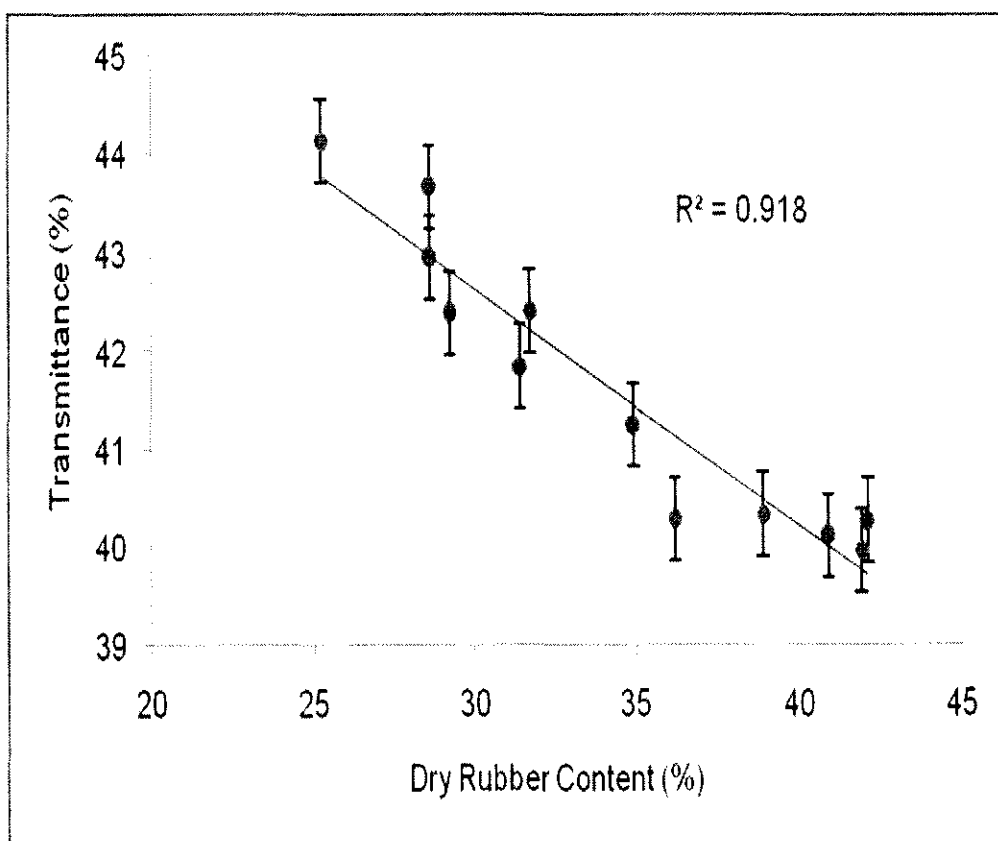

Figure 2.9: Variation of % transmittance at wave number 1375 cm^{-1} with % DRC of latex.



2.1.5: Conclusions

The analysis of IR spectra of natural rubber latex using FTIR spectroscopy in the MIR range has established a direct relation between the normalized differential transmittance at specific wavelengths with the DRC values of the natural rubber latex following laboratory drying method. It is found that the IR absorption at specific wavelengths is due the molecular vibrations of carbohydrates and natural rubber present in natural rubber latex. Though we have established a direct relation between IR transmittance at specific wave numbers 835 cm^{-1} and 1375 cm^{-1} and DRC, we have not studied the IR absorption of non rubber constituents such as lutoids, proteins, lipids and inorganic salts. We assume that the effect of these on the measurements at 835 cm^{-1} and 1375 cm^{-1} is not significant as their characteristic IR absorptions are at different wave numbers of the IR spectrum. Further, we have not studied the effect of anticoagulants and adulterants in latex samples on IR reflectance. We think that the information provided by the present investigations would be useful for quick quantification of dry rubber content in natural rubber latex. In this work we have been able to show that FTIR spectroscopy can be developed in to an accurate technique for the estimation of the DRC of rubber latex, though it does not overcome other limitations such as being expensive and requiring skilled personnel for measurement.

The information collected from the study will be useful in designing a practical DRC measurement system with suitable IR sources and detectors.

With the FTIR technique, quick estimation of the DRC of latex is possible as it quantifies the rubber content directly and other biochemical elements present in the latex do not influence the measurement. Such a system can be accurate, environmental friendly and can be used in the field without the assistance of any skilled personnel. We think that the design and development of a DRC measurement system based on this technique is viable.

2.2: Thermo Gravimetric Analysis

2.2.1: Introduction

In thermo gravimetric analysis (TGA) the mass of a sample in a controlled atmosphere is recorded continuously as a function of temperature or time as the temperature of the sample is increased (usually linearly with time). A plot of mass or mass percent as a function of time is called thermogram⁴³ or a thermal decomposition curve⁴⁴. The TGA technique is widely employed for qualitative as well as quantitative analysis of a wide variety of chemical compounds. Applications of the TGA instrumentation system are analysis of chemical composition of samples, identification of decomposition temperatures, oil volatility measurements, flammability studies, heat of transition, thermal stability analysis, oxidative stability analysis and transition temperature detection. TGA techniques are widely employed for flammability tests on covers of rubber conveyor belts⁴⁵, pyrolysis kinetics of cotton fabrics⁴⁶, thermal degradation of polychloral fiber/cotton blend⁴⁷, analysis of a cellulosic fabric⁴⁸, kinetic analyses of non-isothermal decomposition of

organometallic arylidene polyester⁴⁹, analysis bauxite ore⁶⁰, study H₂O bound to samples of illite-1*M*, illite-2*M*₂ and leucophyllite-1*M*⁵¹, analysis to elucidate water-repellency changes in heated soils⁵², characterization of heavy weight and light weight polypropylene prosthetic mesh explants from a single patient⁵³, properties of fibrillated collagen scaffolds⁵⁴ and so on.

2.2.2: Principle of the method

The new generation thermo gravimetric instruments consists of (1) a sensitive analytical balance, (2) a furnace, (3) a purge gas system for providing an inert atmosphere and (4) a microcomputer / microprocessor for instrument control, data acquisition and display. In addition, a purge gas switching system is a common option for application in which the purge gas or mist gas must be changed during experiment. The thermo balance of TGA system normally provides quantitative information about samples ranging in mass from 1 mg to 100 g and the most common balance available in the latest system has a range from 5 mg to 20 mg. The block diagram of a TGA instrument and a photograph of the instrument used in the present investigations are shown in figures 2.10 and 2.11 respectively.

The sample holder is housed in the furnace and rest of the balance is isolated from the furnace. A change in sample mass causes a deflection of the beam, which interposes a light shutter between a lamp and one of two photo diodes. The resulting imbalance in the photo diode current is amplified and fed in to a coil, which is situated between the poles of a permanent magnet. The magnetic field generated by the current in the coil restores the

beam to its original position. The amplified photo diode current is monitored and transformed into mass or mass loss information by the data acquisition system. In most cases mass versus temperature data can either be plotted in real time or stored for further manipulation or display at a later time.

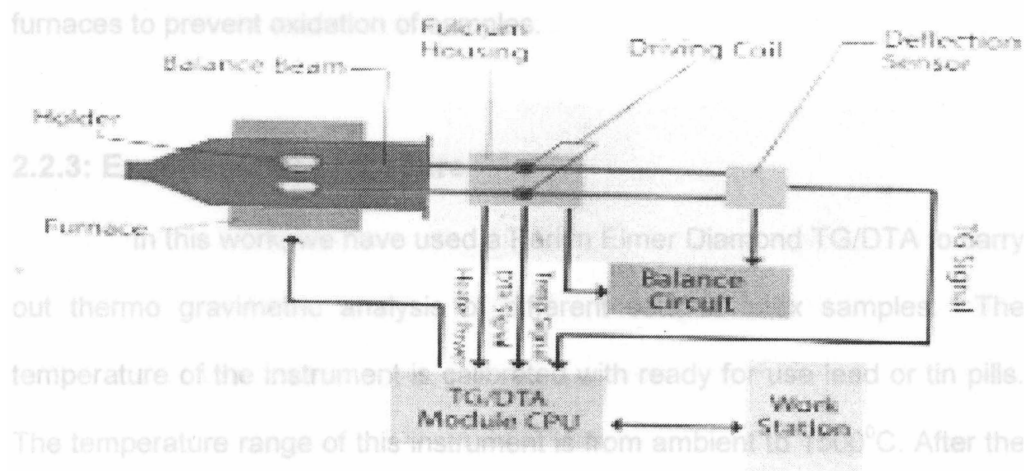

Figure 2.10: Block diagram of a TGA Instrumentation

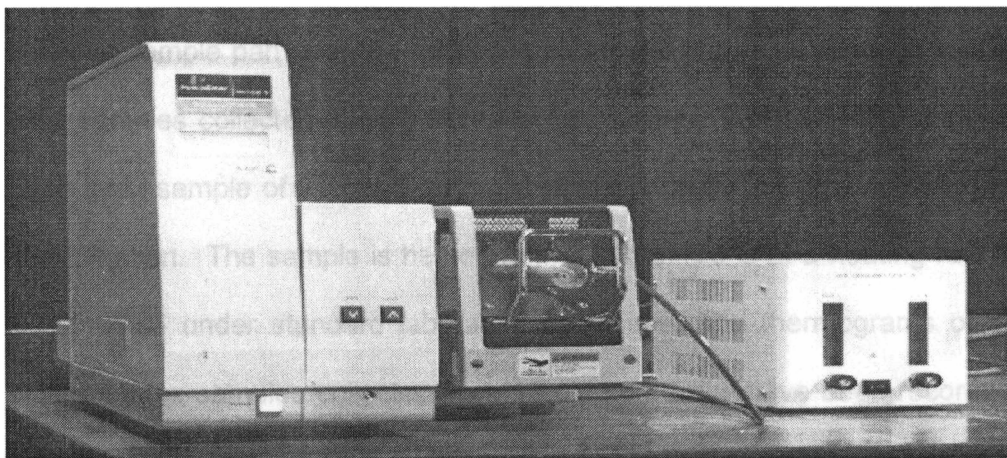

Fig. 2.11: Photograph of the TGA instrument used in the present work (Perkin Elmer Diamond)

New generation system employs a dedicated computer for instrument control and data processing. The furnace of a TGA system operates within a temperature range typically from ambient to 1500°C. The rate of cooling or heating of furnaces can be from somewhat greater than zero up to 200°C/minute. Inert gases such as nitrogen or argon can be used in these furnaces to prevent oxidation of samples.

2.2.3: Experimental procedure

In this work, we have used a Perkin Elmer Diamond TG/DTA to carry out thermo gravimetric analysis of different sets of latex samples. The temperature of the instrument is calibrated with ready for use lead or tin pills. The temperature range of this instrument is from ambient to 1500°C. After the calibration one aluminum pan is placed on the sample pan of the microbalance kept in the furnace of the instrument. The weight difference between sample pan and the reference pan is nullified. Fresh natural rubber latex samples collected directly from the field are used for the TGA analysis. Each latex sample of weight 5-10 mg is placed directly in the aluminum pan after filtration. The sample is heated from 30°C to 170°C at a heating rate of 10°C/minute under standard laboratory conditions. The thermograms of 12 different latex samples collected from 12 different trees have been recorded. The weight loss in each case is determined and plotted against temperature.

The latex samples for all the experiments described in this work have been collected from the experimental field of Rubber Research Institute

of India, Kottayam, Kerala, India. Fresh latex samples from different trees (Clone: RR11 105, Year of planting: 1989-93, D3 tapping system) with wide variations in DRC are collected. The latex samples are filtered and 10-15 ml of each sample is collected in separate containers to determine their DRC values following the standard laboratory drying method and another 10-15 mg of each for TGA measurement, as outlined above.

2.2.4: Results and Discussion

Figures 2.12 (A-C) show the TGA curves for three representative latex samples, recorded from 30°C to 170°C at a heating rate of 10°C per minute. At the end of the heating cycle, the residue remaining in the pan is the dry rubber portion of the sample. Such TGA plots have been recorded for all the samples. The masses of the residues in each case have been expressed as % mass losses between 30°C and 120°C. The mass losses for each sample have been plotted against the corresponding DRC values determined following the laboratory drying method. This variation is shown in Fig. 2.13. It can be seen that the % mass loss varies linearly with DRC values, which is an expected result. This variation has a positive correlation of 0.96.

The objective of this study is to see the variation of weight loss with DRC values when the sample is subjected to a controlled temperature program. The very purpose of this work is to establish the relation, if any, between changes in weight of the latex sample as water escapes from it with its DRC value and see whether it can be used as a technique to measure the

DRC values of unknown samples. We could establish a good correlation between DRC values and the % weight loss values.

Figure 2.12 : Thermograms of three representative samples (A-C)

Fig. 2. 12 (A)

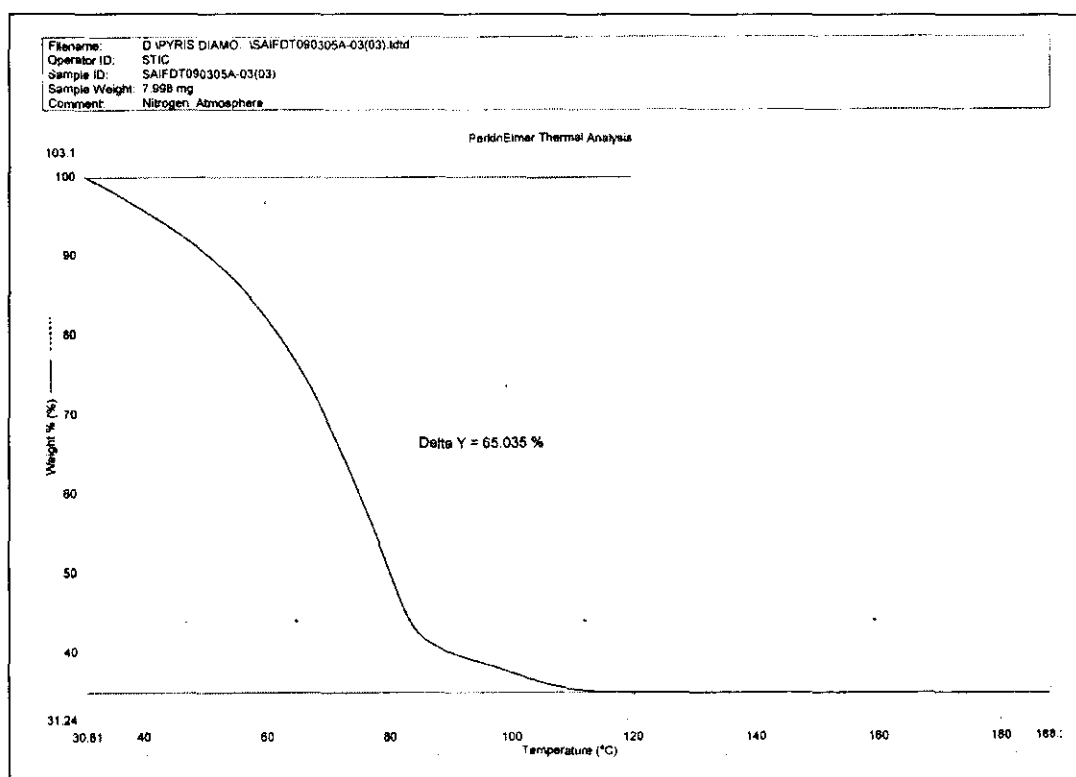

Fig. 2.12 (B)

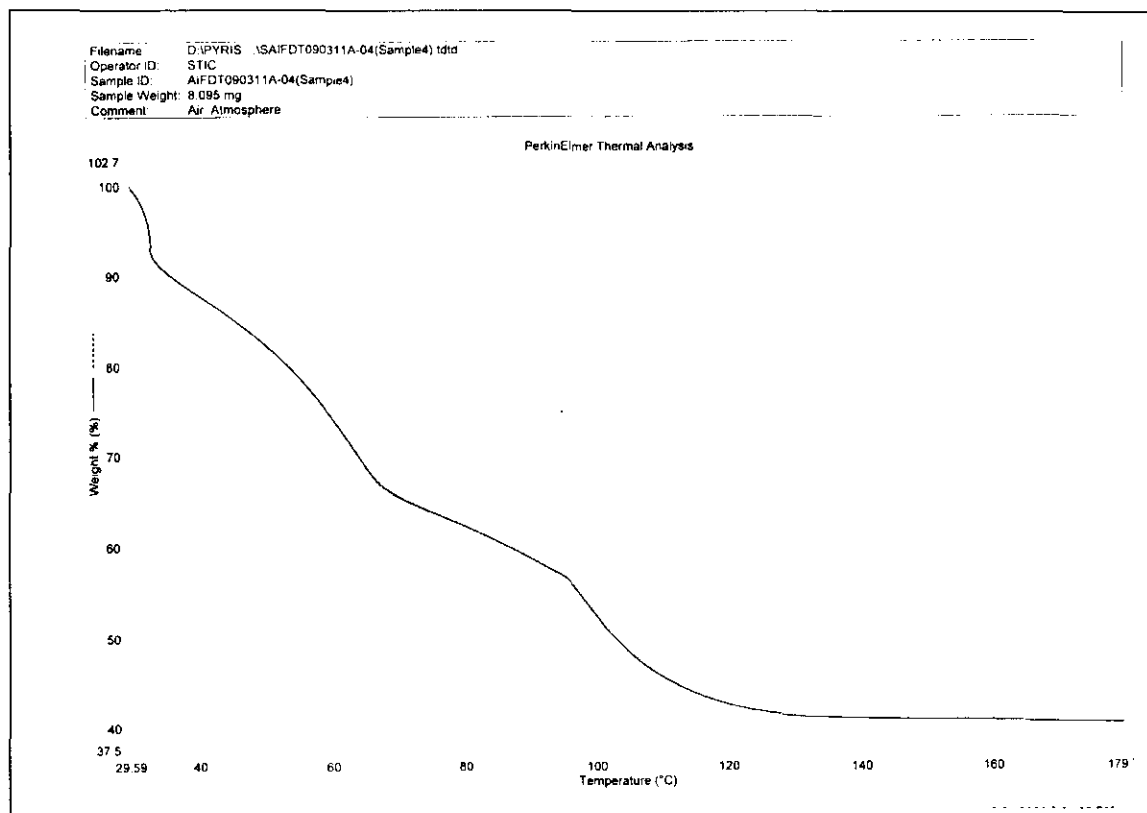

Fig. 2.12 (C)

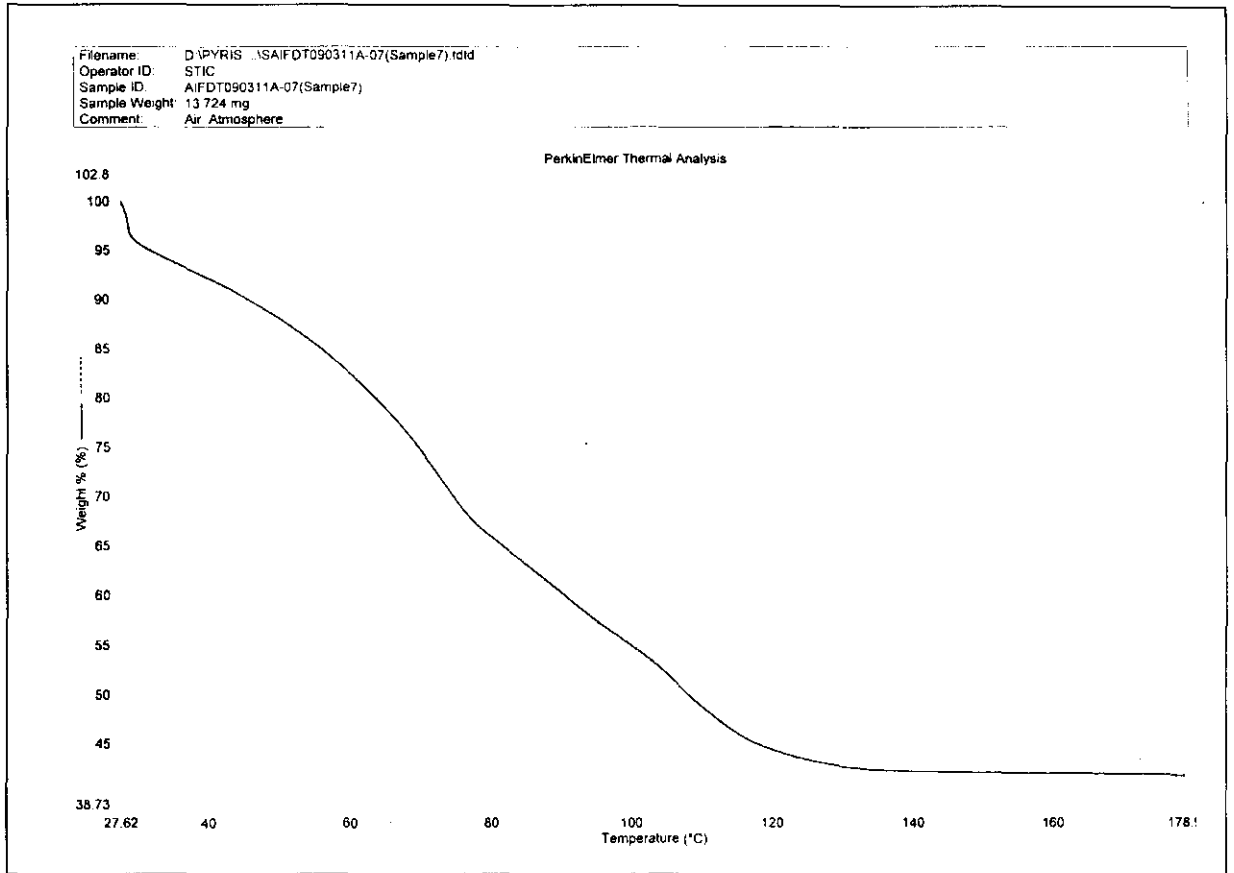

Figure 2.13: Variation of % weight loss determined by with corresponding DRC values obtained from laboratory drying method.

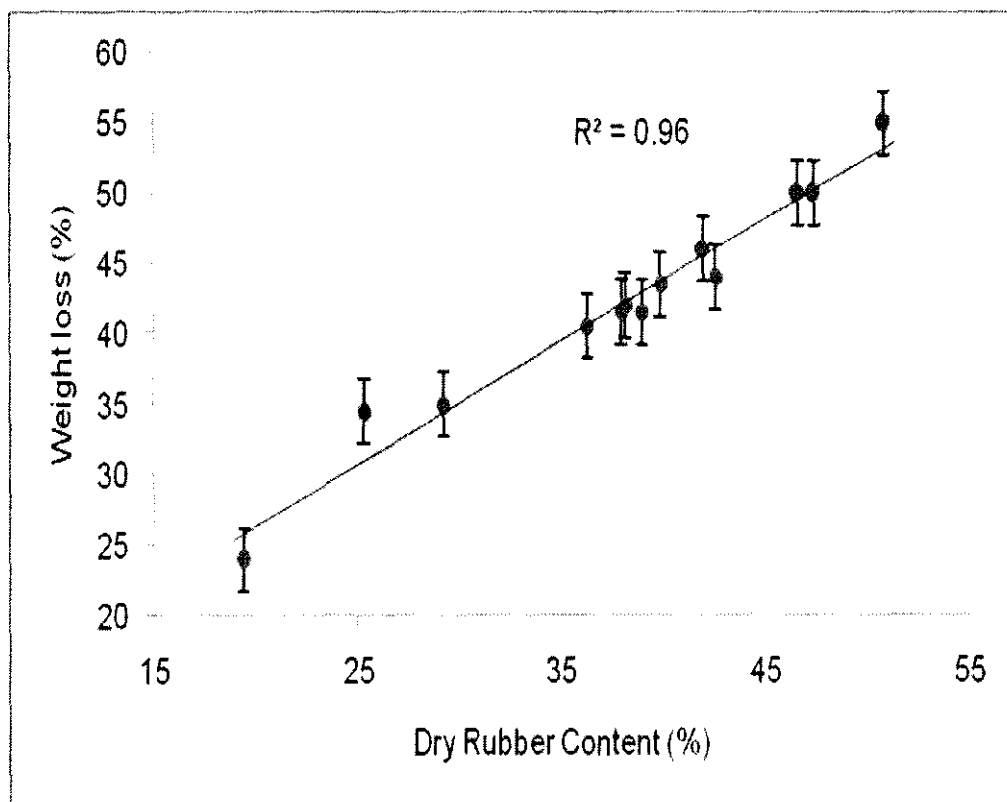

Figure 2.14 : Thermogram of one undiluted centrifuged latex.

Fig. 2.14 (A)

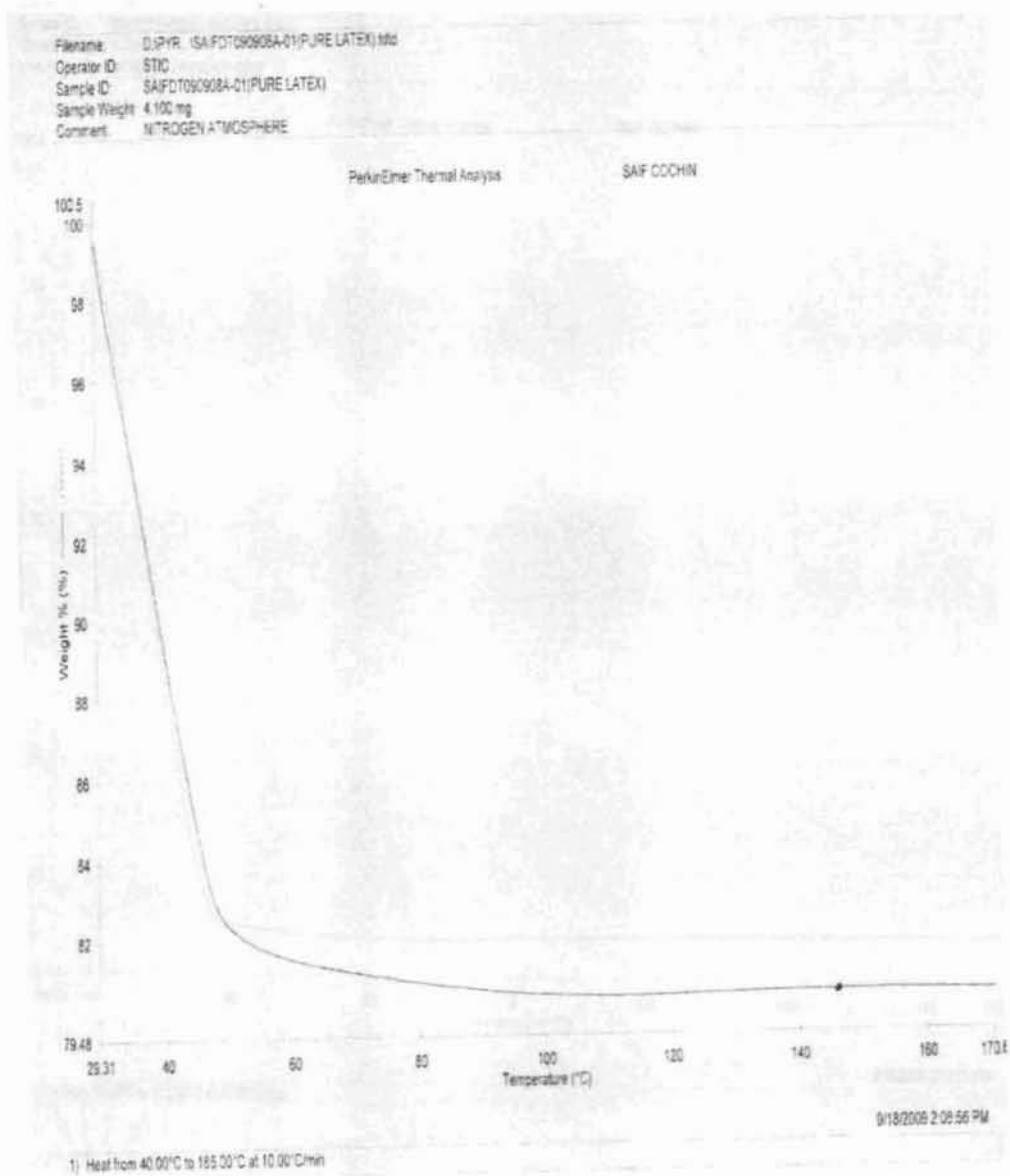

Fig. 2.14 (B): Thermogram of centrifuged latex diluted with 50% water.

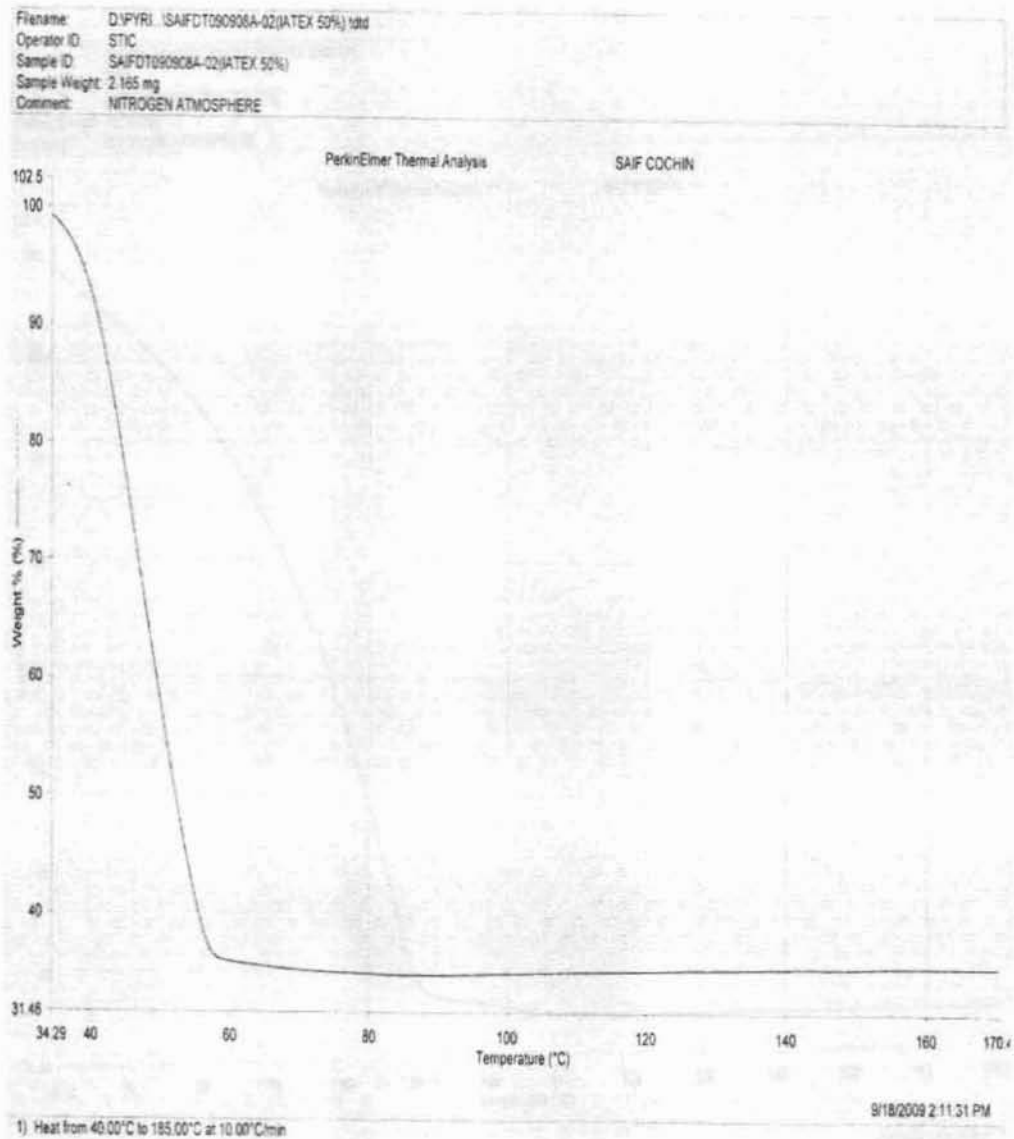

Fig.2.14 (C): Thermogram of centrifuged latex diluted with 66 % water.

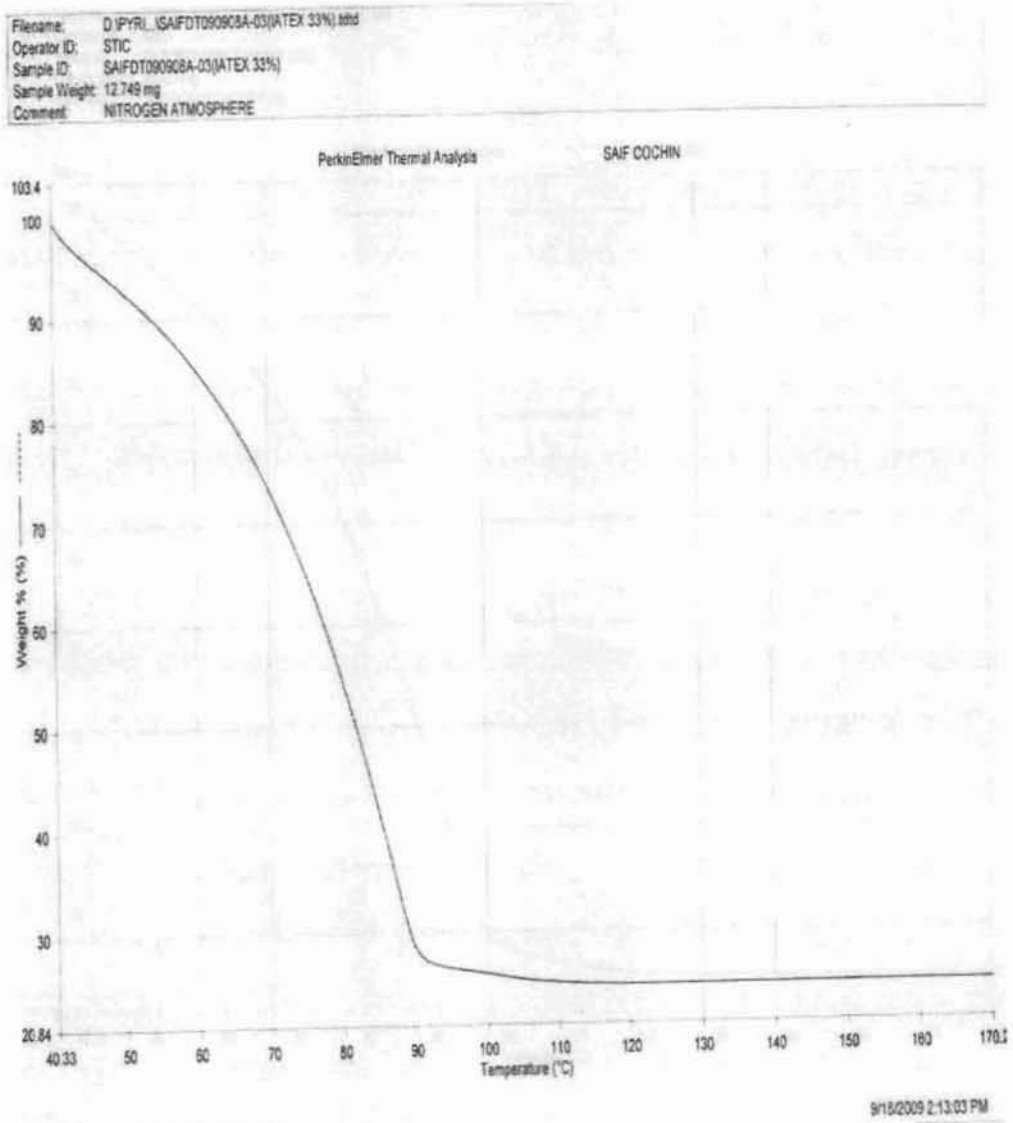
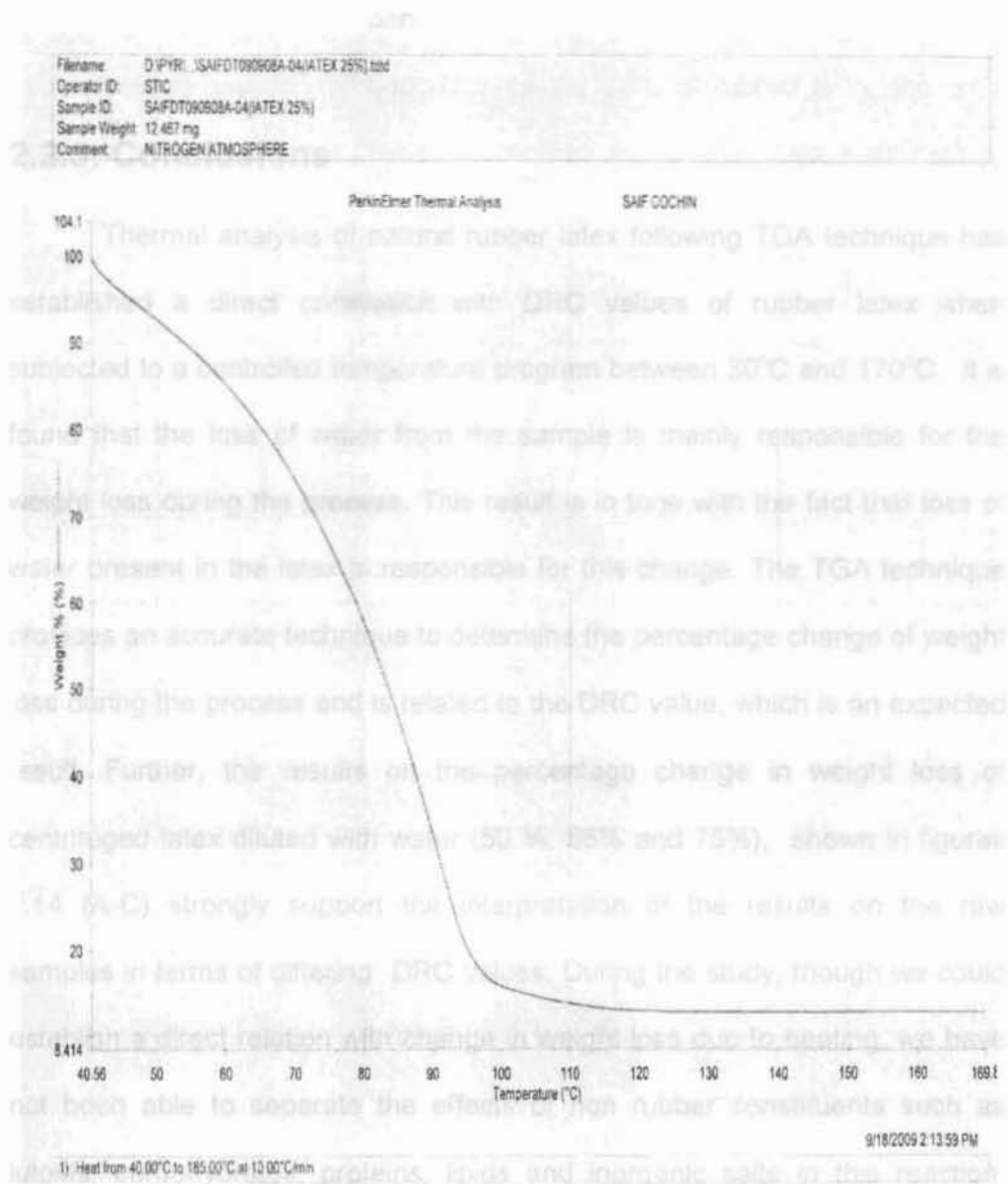

Fig. 2.14 (D): Thermogram of centrifuged latex diluted with 75 % water.



Figures 2.14 (A-D) show the % change in weight loss with temperature for one centrifugal latex sample and diluted with 50%, 66% and

75% water. A comparison of figures 2.13 and 2.14 show that the weight loss between 30°C and 120°C is primarily due to loss of water from the samples.

2.2.5: Conclusions

Thermal analysis of natural rubber latex following TGA technique has established a direct correlation with DRC values of rubber latex when subjected to a controlled temperature program between 30°C and 170°C. It is found that the loss of water from the sample is mainly responsible for the weight loss during the process. This result is in tune with the fact that loss of water present in the latex is responsible for this change. The TGA technique provides an accurate technique to determine the percentage change of weight loss during the process and is related to the DRC value, which is an expected result. Further, the results on the percentage change in weight loss of centrifuged latex diluted with water (50 %, 66% and 75%), shown in figures 2.14 (A-C) strongly support the interpretation of the results on the raw samples in terms of differing DRC values. During the study, though we could establish a direct relation with change in weight loss due to heating, we have not been able to separate the effects of non rubber constituents such as luteins, carbohydrates, proteins, lipids and inorganic salts in this reaction. Moreover, it has not been possible to study the effect of anticoagulants and adulterants on latex samples in a TGA thermogram. We think that the information provided by the present investigations would be useful for quick quantification of dry rubber content in natural rubber latex and to design

quality standards for the products manufactured using natural rubber latex. In this work we have been able to show that Thermo Gravimetric Analysis is an accurate technique for the estimation of the DRC of rubber latex, though it does not overcome other limitations such as being expensive and requiring skilled personnel for measurement.

References

1. American Society for Testing and Materials, Philadelphia, PA. (1997).
2. Etzion, Y., R. Linker, U. Cogan, and I. Shmulevich, *J. Dairy Sc* (2004) **87:2779–2788**.
3. Griffiths, P. R., and J. A. de Haseth, *Fourier transform infrared spectrometry*. John Wiley & Sons, New York, N.Y (1986).
4. Schmitt, J., and H. Flemming, FTIR-spectroscopy in microbial and material analysis. *Intl. Biodeterior. Biodegr* (1998) **41:1–11**.
5. Graham J, Leslie B, Antony W, Marinos E., *Clin Chem* (1999) **45:1077–81**.
6. Franck P, Sallerin JL, Schroeder H, Gelot M.A, Nabet P., *Clin Chem* (1996) **42:2015–20**.
7. Rahman J, Hewlett A, Taylor DR, Xiao SY, Wu JG, Soloway, R.D., *Gastroenterology* (2002) **122 (Suppl): A303**.
8. Kruse-Jarres, J.D, Janatsch, G., Gless, U., Marbach, R., Heise, H.M., *Clin Chem* (1990) **36:401-2**.
9. Christopher, V.E., Arnold, M.A., *Clin Chem* (2001) **47:1279-86**.
10. Rigas B, Morgello S, Goldman IS, Wong, P.T., *Proc Natl Acad Sci U S A* (1990) **87:8140–4**.
11. Koenig, F., et al, *Urology* (1998) **51:342–345**.
12. Wang, H.P., Wang, H.C., Huang, Y.J., *Sci Total Enviro* (1997) **204:283–287**.

13. Huleihel, M. J., *Biochem Biophys Methods* (2002) **50**:111–21.
14. Fung Kee Fung, M., et al, *Gynecol Onco* (1997) **66**:10–5.
15. Argov, S., et al, *J Biomed Opt* (2002) **7**:248-54.
16. Wang, J.S., et al, *World J Gastroenterol* (2003) **9**:1897–1899.
17. Zhao, D.W. et al. *Gastroenterology*. (1996) **110**(Suppl) : A620.
18. Li, W.H. et al, *Gastroenterology* (1997) **112**(Suppl):A604.
19. Wang, J.S., et al, *Chin J Hepatobiliary Surg* (2003) **9**:657–60.
20. Ren, Y., et al, *Spectrosc Spect Anal* (2003) **23**:681–684.
21. Yang, L.M., et al, *Spectrosc Spect Anal* (2003) **23**:883–884.
22. Xu, Y.Z. et al. *Chem J Chin Uni.* (2004) **25**: 348–50.
23. Wu, J.G., et al, *Biopolymers*. (2001) **62**:185–92.
24. Wang, F. et al. *Spectrosc Spect Anal* (2003) **23**:498–501.
25. Xu, Y.Z., et al, *Gastroenterology* (2000) **118**:A6438.
26. Sun, X.J., et al, *Gastroenterology* (2003) **124**(Suppl):A420-421.
27. Peng, Q., Xu, Y.Z., Li, W.H., Zhou, X.S., Wu, J.G., *Spectrosc Spect Anal* (1998) **18**:528–31.
28. Sun, C.W., et al, *Spectrosc Spect Anal* (1996) **16**:22–5.
29. Helm, D., Labischinski, H. & Naumann, D., *J. Microbiol Method.* (1991) **14**: 127-142.
30. Naumann, D., Helm, D. & Schultz, C., *Bacterial Diversity and Systematics*, Edited by F. G. Priest, A. Ramos Cormenzana & B. J. Tindall, New York: Plenum (1994) 67-85.

31. Holt, C., Hirst, D., Sutherland, A. & MacDonald, F., *Appl Environ Microbiol* (1995) **61**: 377-378.
32. Goodacre, R., Timmins, E., M., Burton, R., Kaderbhai, N., Woodward, A. M., Kell, D. B. & Rooney, P., *J. Microbiology* (1998) **144**: 1157-1170.
33. Kummerle, M., Scherer, S. & Seiler, H., *Appl Environ Microbiol.* (1998) **64**: 2207- 2214.
34. Timmins, E. M., Howell, S. A., Alsberg, B. K., Noble, W. C. & Goodacre, R., *J Clin Microbiol* (1998) **36**:367- 374.
35. Tindall, B. J., Brambilla, E., Steffen, M., Neumann, R., Pukall, R., Kroppenstedt, R. M. and Stackebrandt, E., *Environ Microbiol.* (2000) **2**: 310-318.
36. Kirschner, C., et al, *J. Clin. Microbiol* (2001) **39**:1763 –1770.
37. Kummerle, M., S. Scherer, and H. Seiler, *Appl. Environ. Microbiol* (1998) **64**:2207– 2214.
38. Sockalingum, G. D., et al, *Vib. Spectrosc* (2002) **28**:137–146.
39. Galichet, A., G. D. Sockalingum, A. Belarbi, and M. Manfait, *FEMS Microbiol. Lett* (2001) **197**:179–186.
40. Orsini, F., D. Ami, A. M. Villa, G. Sala, M. G. Belloti, and S. M. Doglia, *J. Microbiol Methods* (2000) **42**:17–27.
41. Schmalreck, A. F., P. Trankle, E. Vanca, and R. Blaschke-Hellmessen, *Mycoses* (1998) **41**(Suppl. 1):71–77.

42. Timmins, E. M., D. E. Quains, and R. Goodacre, *Yeast* (1998) **14**:885–893.
43. Douglas, A. Skoog, F. James Hollar and Timothy A., Nieman, *Principles of Instrument Analysis*, Harcourt Brace & Company (1992), 799.
44. Earnest, C.M., *Anal Chem* (1984) **56**:1471A
45. Yuichi Nakagawa, *Journal of Fire Sciences*. (1990) **8(6)**: 455-476.
46. Ning Jianguo, *Journal of Fire Sciences* (1986) **4(5)**: 355-362.
47. Kazuhiko Fukatsu, *Journal of Fire Sciences* (1990) **8(3)**: 194-206.
48. Seyed Morteza Mostashari, *Journal of Industrial Textiles* (1999) **37(1)**: 31-42.
49. Mohamed M.M. Abd El-Wahab, *High Performance Polymers* (1992) **4(4)**: 215-224.
50. Paola Castaldi, Margherita Silveti, Laura Santona, Stefano Enzo and Pietro Melis, *Clays and Clay Minerals* (2008) **56(4)**: 461-469.
51. Victor A. Drits and Douglas K. McCarty, *Soil Sci Soc Am J* (2008) **72**:1-10.
52. Pavel Dlapa, Ivan Simkovic, Jr., *Clays and Clay Minerals* (2006) **54(1)**: 80-86.
53. C.R. Costello, *Surgical Innovation* (2007) **14(3)**:168-176.
54. Natesan Shanmugasundaram, *Clays and Clay Minerals* (1997) **45(2)**: 213-220

CHAPTER THREE

Measurement of Dry Rubber Content in Natural Rubber Latex with a Capacitive Transducer

3.1: Introduction

In October 1745, Ewald Georg von Kleist of Pomerania in Germany invented the first recorded capacitor, a glass jar with water inside as one plate held, on the hand which acted as the other plate. A wire in the mouth of the bottle received charges from an electric machine, and released it as a spark¹. A typical capacitor consists of a pair of conductors separated by a thin layer of dielectric substance - that is, by an electrical insulator that contains essentially no mobile, current - carrying, charged species. The simplest capacitor consists of two sheets of metal foil separated by a thin film of dielectric such as air, oil, plastic, mica, paper, ceramic, or metal oxide. A useful property of a capacitor is its ability to store an electrical charge for a period of time and then to release the stored charge when needed². The capacity is defined as the charge that the capacitor can store per unit of potential difference between the

plates. The capacity of a condenser is increased by interposing a dielectric material between the plates³.

In tensammetry the capacitance of the electrical double layer of an electrode is measured. The capacitance value is strongly influenced by the presence of absorbing species. Although tensammetry is possible at all kinds of electrode surfaces, mercury is the most widely used electrode material¹. Detectors with mercury electrodes (mercury-coated³, dropping mercury^{4,5}, and hanging or static modes⁶) are mainly used for the determination of substances in solutions. Other electrode materials based on the capacitance principle have also been developed. A tantalum capacitance sensor is used for the detection of proteins by immunochemical binding reactions⁷. Berggren and Johansson immobilized monoclonal antibodies on gold substrates. The antibody layers and their interactions with antigens in solution were investigated with capacitance measurements and with cyclic voltammetry. The capacitance change versus the logarithm of antigen concentration is linear over three decades⁸. A gas sensitive semiconductor based on a palladium MOS field effect capacitor for the determination of ammonia in air and aqueous solutions has also been described⁹. The main problem in preparing a stationary working electrode for tensammetric measurements is the formation of a homogeneous and well-defined surface³. Double layers are not a special feature of the electrode-electrolyte interfaces; they are a general consequence of the junction of two phases at a boundary¹⁰. Owing to its high dielectric

constant (78.5 at 25 °C) water is the primary species, which can be measured by changes of the capacitance¹¹. Capacitive transducers are used for root extent measurement¹² of plants and estimating root mass in maize¹³.

Time-resolved patch clamp capacitance measurements are now widely used to study the changes in plasma membrane area associated with exocytosis and endocytosis⁴⁹. For high resolution recordings, a sinusoidal voltage is added to the holding potential, and the resulting current is analyzed by a two-phase lock-in amplifier. When the phase of the lock-in amplifier is properly adjusted, the two outputs directly provide the changes of membrane conductance in one channel and the changes of membrane capacitance in the other channel⁵⁰⁻⁵³. This method is widely used to detect very small capacitance changes and the opening of individual fusion pores in single secretory granules⁵⁴⁻⁵⁷.

Capacitive transducers are extensively used for measuring various physical parameters such as displacement¹⁵, mass²¹, torque²³, micrometer displacements²⁴, force²⁵, strain²⁶, speed^{31,41}, acceleration³², noise⁴⁵, distance⁴⁷, surface force⁴⁸, pressure³⁶, dielectric parameters³⁰ and contact stiffness⁴⁰. Another major application of capacitive transducers is in Ultrasonics^{17, 20,46,59-65,67-80} and its imaging^{27, 29}. Capacitive transducers are also used for the detection of chemicals²⁸, endotoxin³³ and even heavy metals³⁴.

In textile manufacturing, capacitive transducers are used for the measurement of yarn evenness parameters³⁷ and liquid absorption in non woven fabric⁸². Capacitive transducers are used in multi sensor systems³⁸, acoustic emission⁴² and diffraction loss⁸¹ measurements, two dimensional space time analysis⁴³, and in miniature microphones⁶⁶. In agriculture, capacitive transducers are widely employed for the measurement of water intake of plants³⁹, soil water content^{83, 85-87, 89-90,97}, soil salinity effects^{85, 91-92}, soil water dynamics⁹¹⁻⁹⁴, soil analysis⁹⁵⁻⁹⁸, herbage yield¹⁰⁰ and for irrigation control⁸⁸.

In this work, our objective is to develop a method to determine the DRC of rubber latex, by measuring the variation of the capacitance of a specially designed capacitive transducer with the latex acting as the dielectric. The method is found to be accurate, fast, inexpensive, user-friendly and adaptable to varying environmental conditions. The correlation of DRC values with capacitance variation and the related electrical properties, such as impedance, loss factor etc. are established and discussed. The shortcomings and limitations of the method are also discussed.

3.2: Principle of the Method

An elementary parallel plate capacitor consists of two conducting plates, electrically isolated from one another by an insulating medium. The capacitance (C) of this elementary capacitor is proportional to (i) the cross -

sectional area A of the plates, (ii) the permittivity (or dielectric constant K) of the insulating medium and (iii) the reciprocal of the separation, t, between the plates. The relation is given by¹⁰¹

$$C = \frac{KA}{t} \quad \dots\dots 3.1$$

If the area of the plates and the separation between them are kept constant, the capacitance of the capacitor is directly proportional to the dielectric constant or permittivity of the medium. If there is a direct relation between the DRC and dielectric constant of latex, then the same relationship should hold good for the capacitance and DRC of rubber latex, if used as the dielectric. A capacitor, when connected to a sinusoidal voltage source, responds to it sinusoidally with definite impedance following the relation,

$$V = V_o e^{j\omega t} \quad \dots\dots 3.2$$

where the angular frequency $\omega = 2\pi f$, stores, f being the test frequency

When vacuum is it's dielectric, the induced a charge,

$$Q = C_o V \quad \dots\dots 3.3$$

and draws a charging current given by

$$I_c = \frac{dQ}{dt} = j\omega C_o V, \quad \dots\dots 3.4$$

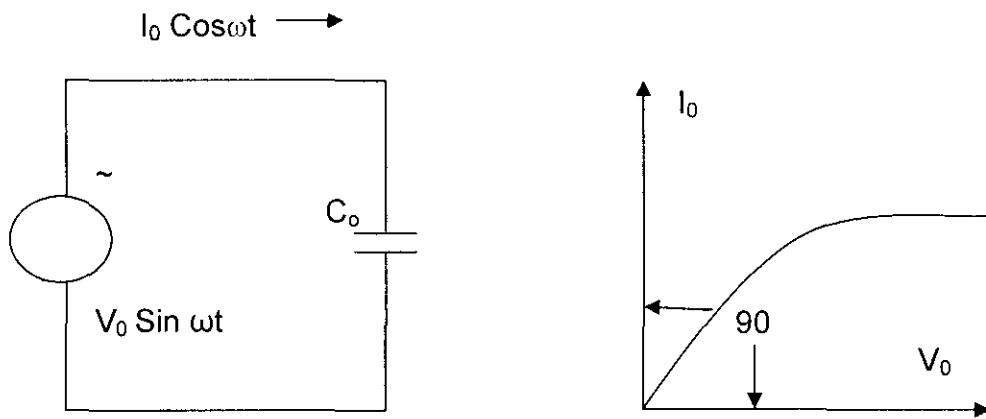

Fig 3.1: Current –voltage relation in an ideal capacitor

which leads the voltage by a temporal phase angle of 90° (Fig. 3.1). C_0 is the vacuum (or geometrical) capacitance of the capacitor. Here, V is the instantaneous voltage, V_0 is the peak value of voltage, ω is the signal angular frequency and t is the time. When filled with a dielectric medium of absolute permittivity ϵ' , the capacitance value gets modified as

$$C = C_0 \epsilon' / \epsilon_0 = C_0 K' \quad \dots\dots 3.5,$$

where C_0 is the capacitance with air or vacuum as the dielectric, ϵ_0 is the permittivity of free space and K' is the dielectric constant of the medium. A dielectric material with higher relative permittivity enhances the storage capacity of a capacitor by neutralizing the charges at the electrode surfaces, which otherwise would have contributed to the applied external field. The impedance of a capacitor is not a pure reactance, but is modified by the series resistance of the leads and plates, losses in the dielectric, parallel resistance

of the plates and leakage effects. One way to handle this complex situation is to combine all these effects in to an equivalent series resistance (R_s), measured directly with an impedance bridge or indirectly with instruments such as Q meters. The overall impedance of the system is given by

$$\mathbf{Z} = R + j\mathbf{X} \quad \text{.....3.6}$$

where X is the reactance of the capacitor. The impedance, Z, is the inverse of admittance, Y,

$$\text{or, } \mathbf{Y} = 1/\mathbf{Z} \quad \text{.....3.7}$$

$$\text{or } \mathbf{Y} = \mathbf{G} + j\mathbf{B} \quad \text{.....3.8}$$

where $\mathbf{G} = 1/R$ and $\mathbf{B} = \omega C_p$

Here G is the conductance, C_p is the parallel plate capacitance and B is the susceptability of the medium.

$$\omega = 2\pi f, f \text{ being the test frequency.}$$

The dissipation factor D can be expressed as

$$\mathbf{D} = 1/Q \quad \text{.....3.9}$$

where Q is the quality factor. The equivalent resistance (R) of the capacitor is given by

$$\mathbf{R} = |\mathbf{Z}| \cos \theta \quad \text{.....3.10}$$

where $|Z| = \sqrt{R^2 + X^2}$, and $\theta = \tan^{-1} (X/R)$, θ being the phase lag due to capacitive reactance.

3.3: Capacitance Transducer Design and Measurement

Method

3.3.1: General description

Experimental set up presented in this chapter consists of a specially designed capacitive transducer and an LCR (Inductance, Capacitance, Resistance) meter. The designed capacitive transducer consists of six concentric metallic cylinders with increasing diameters, insulated from each other and firmly fixed. Each cylinder acts as the plate of a capacitor with the alternate cylinders connected externally in parallel to increase the effective area of the electrodes.

The equivalent diagram of the capacitor combination and a schematic diagram of the assembled capacitive transducer are shown in Figures 3.2 and 3.3 respectively. The block diagram of the experimental set up used for measurements is shown in Figure 3.4. The effective capacitance of the capacitive transducer is C and is given by

$$C = C_1 + C_2 + C_3 + C_4 \quad \dots\dots\dots 3.11$$

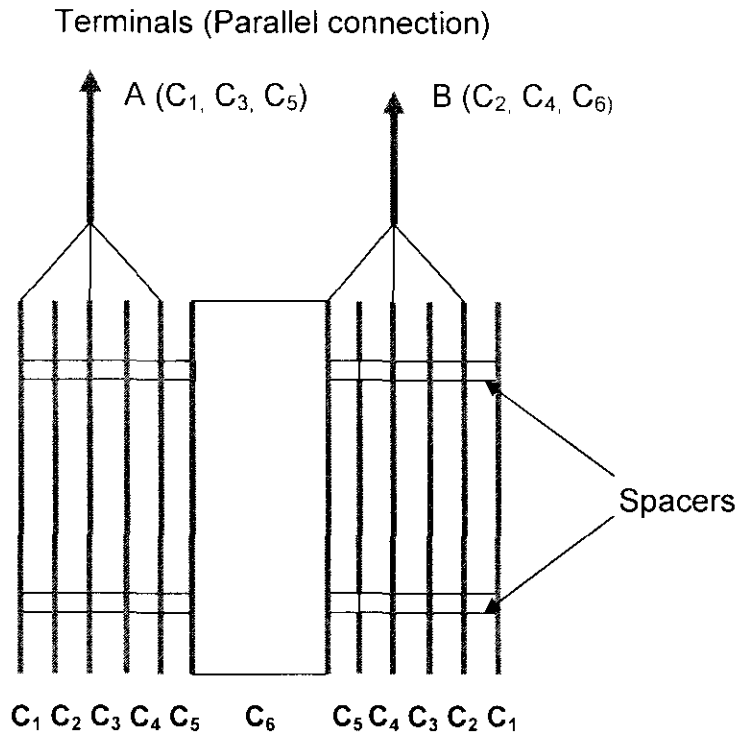

Fig 3.2: Assembled capacitive transducer

Figure 3.2 shows arrangement of the individual capacitors in the capacitance transducer. The capacitance transducer is fabricated using six hollow tubes (Aluminum) of increasing diameters. The tubes are finely machined to obtain a uniform wall thickness throughout its length. The length of each tube is seven centimeters and all the tubes are arranged according to the diameters as shown in the figure. The cylinders are placed 1 mm apart and insulated using a Teflon spacer. Holes of size 0.5 mm are drilled into the walls of the tubes vertically to take out the connection leads. High quality wires are positioned into these holes and punched using special tools. The connections

are checked thoroughly to ensure that there are no failures. Parallel connections are derived from the transducer as shown in the figure. Assembled tubes are then firmly fixed on a Teflon sheet to hold the tubes in position.

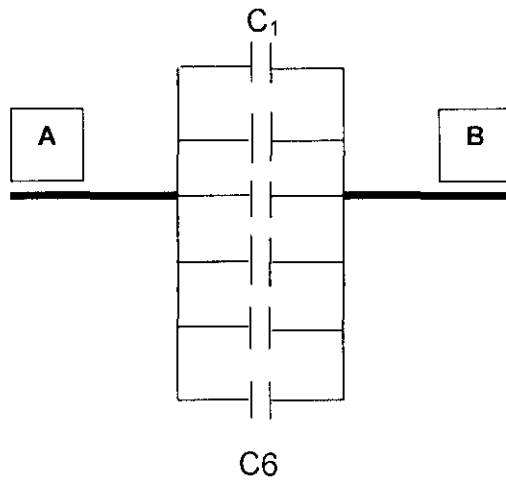

Fig 3.3: Equivalent Capacitive transducer

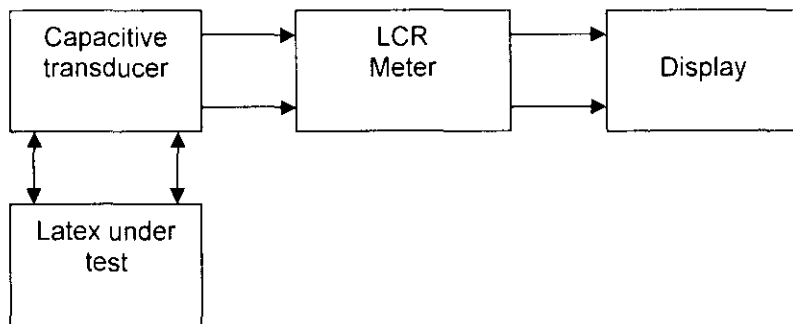

Fig 3.4: Block diagram of the measurement set up

This capacitive transducer is immersed in a beaker containing a constant volume of latex (400 ml), whose capacitance is to be measured. The terminals A and B of the assembled capacitive transducer (Figure 3.1) are connected to an LCR meter (Agilent Technologies Model 4263 B) for measuring the capacitance with natural rubber latex as the dielectric medium. The capacitance, as well as other parameters, is measured at a frequency of 100Hz under standard laboratory conditions. All measurements have been carried out within four hours of collecting the samples from the collection Centre. Other parameters such as resistance (R), dissipation factor (D), impedance (Z) and susceptibility (G) are also measured with the same LCR meter. All these parameters for different samples with different DRC values are measured under the same physical and environmental conditions for direct comparison.

3.3.2: Sample collection and preservation for measurement

The latex samples for all the experiments described in this work, are collected from the Factory Management Division (FMD) of Rubber Research Institute of India, Kottayam, Kerala, India. This division collects latex from small holders as well as from the experimental farm of Rubber Research Institute of India to make value added latex products. For the work presented in this thesis, latex samples (Clone: RR11 105, Year of planting: 1989-93, D₃ tapping system) with wide variations in DRC are collected. The latex samples

are collected after filtration and an anticoagulant is added to each sample to preserve it. The amount of anticoagulant (Ammonia) added to each sample is kept constant to ensure that the effect of the anticoagulant is the same in all measurements. After the preparation of latex samples by adding the anticoagulant, 10-15 ml of each sample is collected in separate containers to determine their DRC values following the standard laboratory drying method and another 400 ml of the latex for capacitance measurement, as outlined above. The general procedure of the laboratory drying method is to coagulate a known weight of representative sample of the latex with dilute acetic acid, sheet the coagulum and dry it at about 75°C in an oven. The DRC of the latex is therefore the percentage by weight of the dry sheet over the weight of latex under test

3.4: Results and Discussion

The experimental data collected from a series of measurements on different sets of samples are presented in Table 3.1. The parameters tabulated and their units are listed at the bottom of the table. The estimated uncertainties of each of the parameters are also indicated in this table. Figures 3.7 to 3.10 show the variations of series and parallel capacitance values of the capacitive transducer as well as other parameters with DRC of the latex. The results obtained are analyzed using standard statistical tools.

The parallel and series capacitance values exhibit high negative correlations (-0.84 and -0.86 respectively), whereas the Dissipation factor (D)

and Resistance (R) exhibit a high positive correlations (0.76 and 0.79 respectively). Impedance (Z) shows a medium positive correlation (0.59). The uncertainties indicated in the figures take into account all the uncertainties involved in the measurement of DRC and capacitance values. One can notice that both series and parallel capacitances of the capacitor are inversely proportional to the DRC of the latex. The proportionality constants obtained are 0.123nF/%DRC and 0.117nF/%DRC respectively.

The purpose of this work is to see whether a relation between the DRC of rubber latex with its dielectric properties could be established. With a proper design of the present capacitive transducer, we see that the capacitance, in general, is inversely proportional to the DRC and it can be measured with sufficient sensitivity and accuracy. The other electrical/dielectric properties naturally follow the dielectric constant or permittivity of the medium. For the design of a practical measuring instrument one need not measure all the parameters presented in Table 3.1. We find that the series capacitance of the measuring capacitor is most sensitive to variations in DRC compared to other measured parameters.

While designing a practical DRC meter following this scheme, one need to provide provision to measure just the series capacitance accurately. We think that such an instrument can be made at a comparatively low cost and the measurements can be done in the field with a battery- operated instrument. Since the DRC measurements need to be made by non- technical personnel working at latex collection centers, it is important that the instrument

is made user friendly and the measurements are done in a short period of time. The design and fabrication of such an instrument, we think, is feasible.

Table 3.1: Variation of capacitance and other physical parameters with DRC of latex.

No	DRC (%)	Cp (nF)	Cs (nF)	D	R (Ω)	Z (Ω)
1	25.2	928.4	928.8	0.0234	40.75	1.7167
2	28.6	928.2	928.7	0.0241	42.33	1.7145
3	29.2	928.0	928.5	0.0248	43.54	1.7147
4	30.3	927.9	928.3	0.0244	42.91	1.7152
5	31.4	927.7	928.2	0.0246	43.50	1.7155
6	33.4	927.2	927.9	0.0251	44.38	1.7165
7	34.9	926.7	927.2	0.0251	44.26	1.7176
8	36.8	927.5	928.1	0.0249	44.19	1.7157
9	36.8	927.3	927.7	0.0247	43.37	1.7164
10	38.9	927.6	928.0	0.0241	42.62	1.7160
11	40.9	926.8	927.3	0.0262	45.79	1.7169
12	41.9	926.0	926.7	0.0264	47.35	1.7222

Cp- Parallel capacitance, Cs- Series capacitance, D-Dissipation factor, R- Resistance, Y- Admittance, G-Suceptance, nF- nano farad, Ω - ohm, ms- milli siemens.

Figure 3.5: Variation of series capacitance with % DRC of latex. Measurement uncertainties are indicated in the figure.

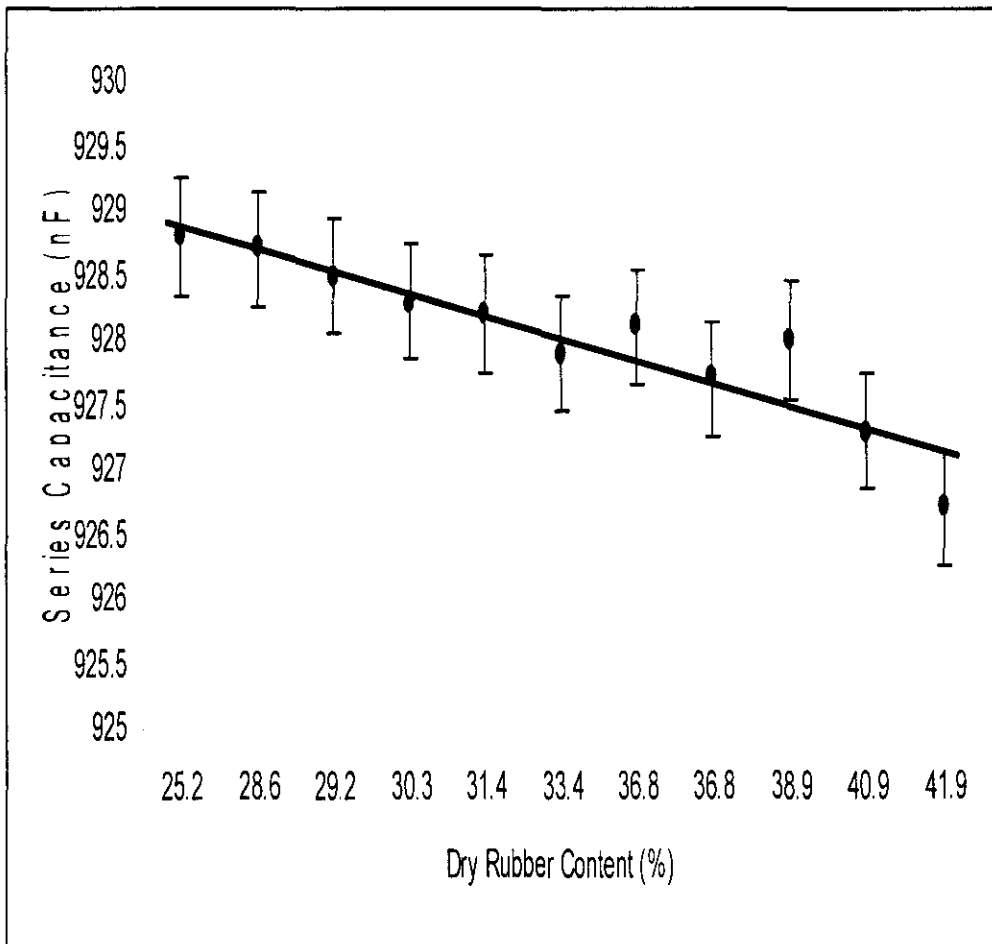

Figure 3.6: Variation of parallel capacitance with % DRC of latex.

Measurement uncertainties are indicated in the figure

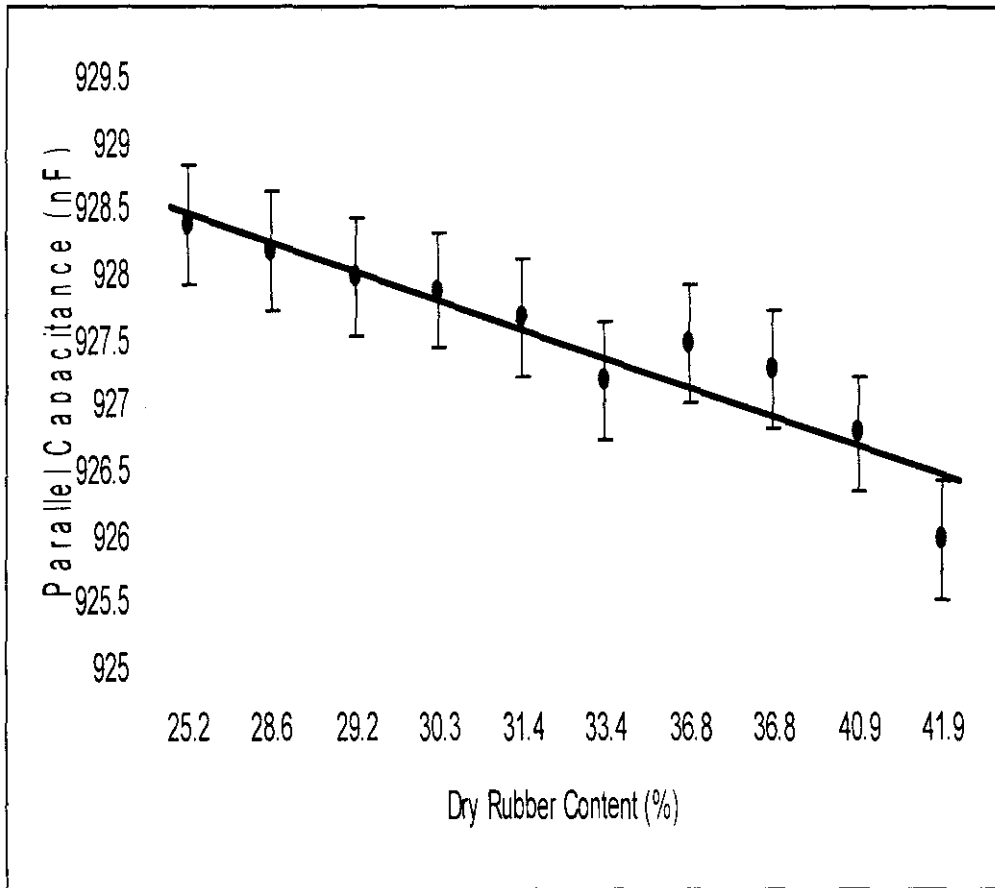

Figure 3.7: Variation of dissipation factor with % DRC of latex. Measurement uncertainties are indicated in the figure.

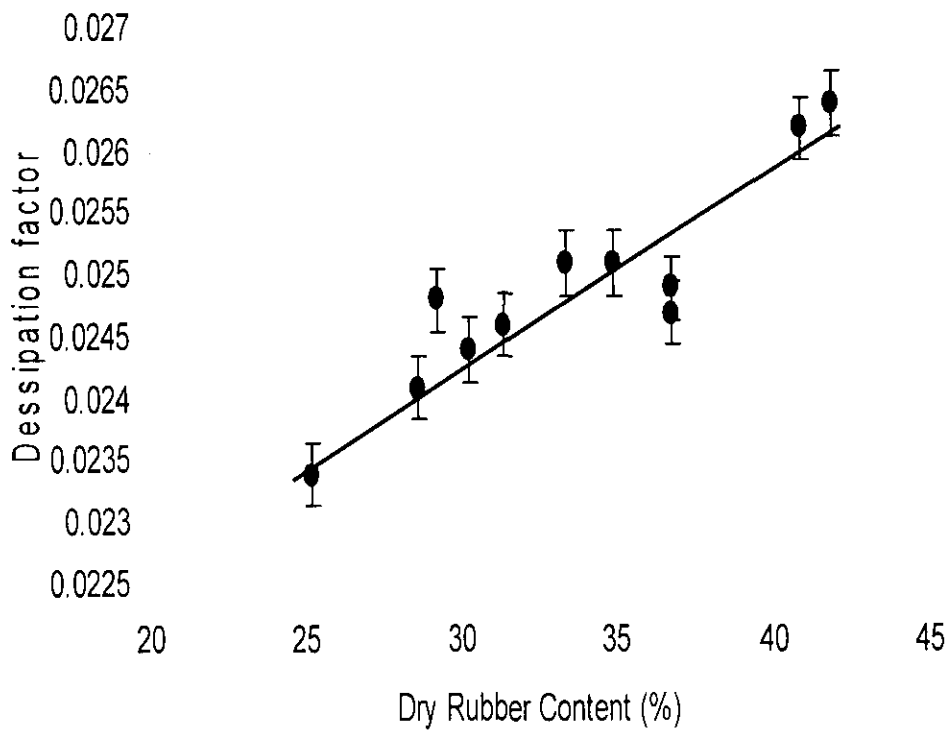
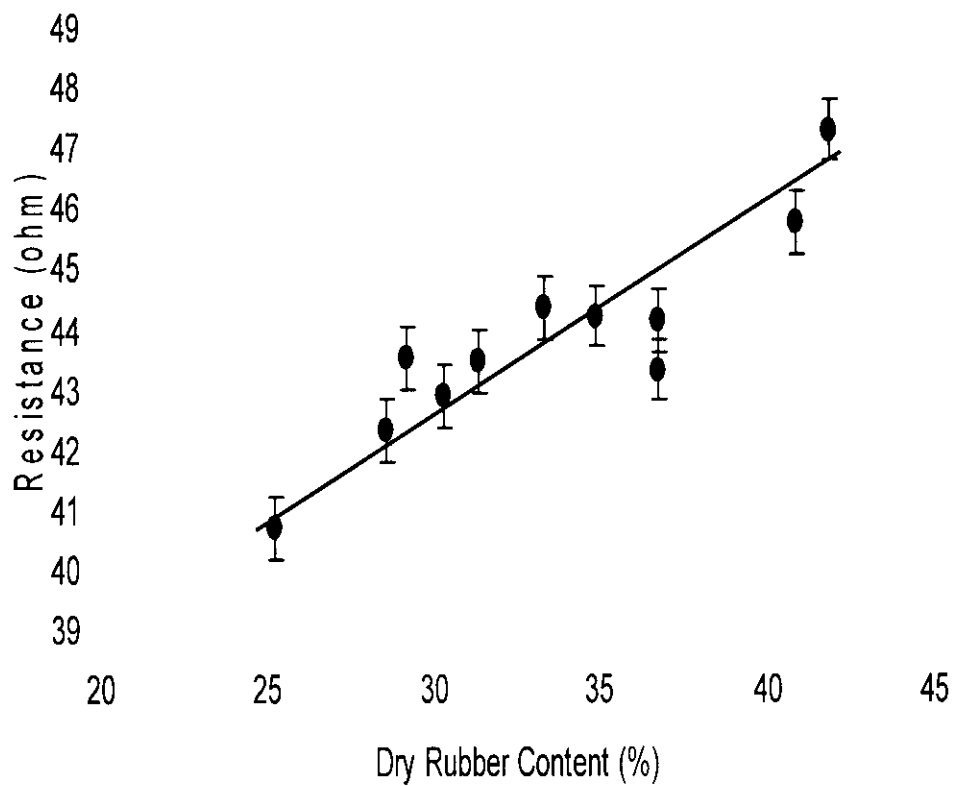

Figure 3.8: Variation of resistance with % DRC of latex. Measurement uncertainties are indicated in the figure.



3.5: Limitations of the Method

Though we could establish a good correlation between DRC values and the corresponding capacitance values of natural rubber latex, this technique suffers from several limitations. Natural rubber latex, as already explained, contains lutoids and inorganic ions which contribute to ionic activity in this colloidal dispersion. As time passes breaking of more lutoids takes place thereby releasing more ion pairs into the medium. These ion pairs certainly increases the ionic activity in latex contributing to a change in capacitance values of the latex. Owing to this activity and the possible variation in capacitance measurements this method suffers from nonreproducibility of the results. Another drawback of this method is the effect of the anticoagulant. The latex, immediately after collection at the collection centre is treated with anticoagulant for preservation. The addition of anticoagulant also alters the polar nature of the medium and this in turn affects the capacitance measurement. Moreover, this technique requires high sample volume (400 ml) and so a tree - wise measurement of DRC of latex for scientific purposes is rather difficult.

3.6: Conclusions

We have been able to establish a good correlation between DRC and dielectric/electrical properties of natural rubber latex samples. It is found that DRC is sensitive to the capacitance of the specially designed capacitor, which could be used to design a practical instrument, based on the above principle.

Even though we have been able to establish the relationships between DRC and dielectric/electrical properties of rubber latex, we have not attempted to bring out the microscopic phenomena responsible for the observed effects. Further, we have not investigated the influence of non-rubber constituents and adulterants in these measurements. Interpretation of the results in terms of the molecular polarizability of the medium would be very informative to understand the electrochemical processes relevant to this complex medium. We estimate that a practical measurement system following this method will have measurement uncertainties up to $\pm 2\%$ due to various factors. However, we think that the measurement uncertainties can be reduced considerably by optimizing the transducer design and measurement procedures. In spite of these positive aspects, the method suffers from the limitations discussed earlier. Due to these limitations it is not advisable to make efforts to develop instruments to measure DRC of latex based on capacitive transducers.

References

1. Zorpette and Glenn, *IEEE Spectrum*,(2005) **42 (1)**: 32.
2. Douglas A. Skoog, James Hollar, F and Timothy A. Nieman, *Principles of Instrumental Analysis*, Harcourt Brace College Publishers, Chicago (1998) 30-31.
3. Bos, M., Van Willigen, and Van Der Linden, W.E., *Anal. Chim. Acta* (1984) **156**: 71.
4. Bos, M., *Anal. Chim. Acta* (1982) **135**: 249.
5. Rosen, M.J., Hua, X., Bratin, P., and Cohen, A.W., *Anal. Chem* (1981) **53**: 232.
6. Emons, H., Schmidt, T and Stulik, K., *Analyst*. (1989) **114**: 1593.
7. Gebbert, A., Alvarez- icaza, M., Stcklein, W., and Schmid, R.D., *Anal. Chem* (1992) **64**: 997.
8. Berggren, C. and Johansson, G., *Anal. Chem* (1997) **69**: 3651.
9. Winqvist, F., Spetz, A., Lundstrm, I and Danielsson, B., *Anal. Chim. Acta*. (1984) **164**: 127.
10. Bockris, J.O.M. and Reddy, A.K.N., *Modern electrochemistry*, A Plenum Rosetta Edition (1973) 2: 630-632.
11. Janata, J., *Principles of Chemical Sensors*, Plenum Press, New York (1989) 231.
12. Dalton, F.N., *Plant and Soil* (1995) **173**:157-156.
13. Van Been, J., Smith, M., and Zobel, R., *Agronomy Journal* (1998) **90**:566-570.

14. Carr, H and Wykes, C., *Ultrasonics* (1993) **31**: 13-20.
15. Franco Cabiati and Valter Giaretto, *Rev. Sci. Instrum* (2000) **71**: 1887.
16. Ashkan and Hossein Golnabi, *Rev. Sci. Instrum* (1999) **70**: 3483.
17. Ergun, A. S., A. Atalar, B. Temelkuran, and E. Özbay, *Appl. Phys. Lett* (1998) **72**: 2957- 2959.
18. Huang, S., Green, R.G., Plaskowski, A., and Beck, M.S., *Instrumentation and Measurement, IEEE Transactions* (1988) **37 (3)**: 368 – 373.
19. Schindel, D. W., D. A. Hutchins, L. Zou, and M. Sayer, *IEEE Trans. Ultrason. Ferroelectr. Freq. Control* (1995) **42**: 42–50.
20. Soh, H.T., I. Ladabaum, A. Atalar, C. F. Quate, and B. T. Khuri Yakub, *Appl. Phys. Lett* (1996) **69**: 3674.
21. Hossein Golnabi Simple, *Rev. Sci. Instrum* (1997) **68**: 1613.
22. Holland, S. D., S. V. Teles, and D. E. Chimenti *J. Acoust. Soc. Am.* (2004) **115**: 2866–2872.
23. Turner, J.D., *J. Phys. E: Sci. Instrum* (1989) **22**: 82-88.
24. Schofield, J.W., *J. Phys. E: Sci. Instrum* (1972) 5822-5825.
25. Cannella, M and F. Marinozzi, *Rev. Sci. Instrum.* (2001) **72**: 3411.
26. Strittatter, R.P., R. A. Beach, G. S. Picus, and T. C. McGill, *J. Appl. Phys.* (2003) **94**: 5958.
27. Robertson, T. J., D. A. Hutchins, and D. R. Billson, *Meas. Sci. Technol.* (2002) **13**: 758–769.

28. Park, K.K., H. J. Lee, G. G. Yaralioglu, A. S. Ergun, Ö. Oralkan, M. Kupnik, C. F. Quate, and B. T. Khuri-Yakub, *Appl. Phys. Lett* (2007) **91**: 94-102.
29. Liu, W., Zagzebski, et al, *Physics in Medicine and Biology* (2008) **53(15)**: 4169-4183.
30. Bera, S.C and Chattopadhyay, S.A., *Measurement*. (2003) **33 (1)**: 3 - 7.
31. Mohammed, E.B and Rehman, M., *Measurement Science and Technology*. (2002) **13(12)**: 2027-2031.
32. Gotlib, V.M., et al, *Cosmic Research* (2004) **42 (1)**: 54-59.
33. Limbert, et al, *Analytical and Bio analytical Chemistry*. (2007) **389 (2)**: 517-525.
34. Saatci, etal, *International Journal of Environmental and Analytical Chemistry* (2007) **87(10-11)**: 745-754.
35. Chiou, etal, *Micro system Technologies* (2008) **14(6)**: 787-797.
36. Aebersold, J., et al, *Invest Ophthalmol Vis Sci* (2008) **49**: E-Abstract 688.
37. Joao, L., Monteiro, Filomena, O., Soares, and Rosa M. Vasconcelos, *Yarn Textile Research Journal* (2008) **78 (2)**: 119-127.
38. Gerard, C. M., Meijer, Frank, M. L., Vander Goes, Paul C. De Jong, Xiujun Li, and Ferry N. Toth, *Journal of Intelligent Material Systems and Structures* (1999) **10 (2)**: 105-115.
39. Mcdonald, A. J. S., J. R. Jordan and E. D. Ford Leice, *Transactions on Electronics E90-C* (2007) **10**:1892-1899.

40. Syed Asif, S.A., K. J. Wahl and R. J. Colton, *Rev. Sci. Instrum* (1999) **70**:2408.
41. Rehman, M., and V. G. K. Murti, *Phys. E: Sci. Instrum* (2001) **13**: 655-657.
42. Ozevin, D., D W Greve, I. J. Oppenheim and S. P. Pessiki, *Smart Mater. Struc* (2006) **15**: 1863-1871.
43. Zhang, Z.Y., and J. X. Luo, *J. Phys. Conf. Ser* (2006) **48**: 274-280.
44. Mol, L., L A Rocha, E Cretu and R. F., Wolffenbuttel, *J. Micromech. Microeng* (2008) **18**: 6.
45. Andrea Marin, *et al.*, *Class. Quantum Grav* (2002) **19**: 1991-1996.
46. Mattila, P., J Stor-Pellingén, J. Ignatius, J. Hietanen and M. Luukkala, *Meas. Sci. Technol* (2000) **11**: 1119-1125.
47. Alexander Steiner, *Meas. Sci. Technol* (2000) **11**: 865-869.
48. Stewart, A. M., *Meas. Sci. Technol* (2000) **11**: 298-304.
49. Lindau, M. Q., *Rev. Biophys* (1991) **24**:75-101.
50. Neher, E., and A. Marty, *Proc. Natl. Acad. Sci, USA* (1982) **79**:6712-6716.
51. Joshi, C., and J. M., Fernandez, *Biophys. J* (1988) **53**:885-892.
52. Lindau, M and E. Neher, *Pflügers Arch. Eur. J. Physiol* (1988) **411**:137-146.
53. Gillis, K. D. *Techniques for membrane capacitance measurements*, In *Single-Channel Recording*, 2nd ed. B. Sakmann and E. Neher, editors. Plenum Press, New York (1995) 155-198.
54. Breckenridge, L. J., and W. Almers, *Nature* (1987) **328**: 814-817.

55. Spruce, A. E., L. J. Breckenridge, A. K. Lee, and W. Almers, *Neuron* (1990) **4**: 643-654.
56. Lindau, M. Q., *Rev. Biophys* (1991) **24**:75-101.
57. Hartmann, J., and M. Lindau, *FEBS Lett* (1995) **363**:217-220.
58. Peter Frantx, Alexander Artsyukhovich, Robert W. Carpick and Miquel Salmeron, *Langmuir* (1997) 5957-5961.
59. Haller, M. I. and B. T. Khuri Yakub, *Proc. IEEE Ultrason. Symp.*,(1994) 1241–1244.
60. Jin, X. C., I. Ladabaum, F. L. Degertekin, S. Calmes, and B. T. Khuri Yakub, *J. Microelectromechanical Systems* (1999) **8(3)**: 100 -114.
61. Huang, Y., A. S. Ergun, E. Haeggstrom, M. H. Badi, and B. T. Khuri Yakub, *J. of Micro electromechanical Systems* (2003) **12(2)**: 128 -137.
62. Jin, X. C., O. Oralkan, F. L. Degertekin, and B. T. Khuri-Yakub, *IEEE Trans. on Ultrason. Ferroelect. Freq. Contr* (2001) **48**: 750 - 759.
63. Bayram, B., et al., *IEEE Trans. on UFFC* (2005) **52(2)**: 326 - 339.
64. Ladabaum, I., X. C. jin, H. T. Soh, A. Atalar, and B. T. Khuri Yakub, *IEEE Trans. Ultrason., Ferroelect. Freq. Cont* (1998) **45(3)**:678 - 690.
65. Ecceaedt, P., K. Niederer and B. Fisher. *Ultrasonics Symp*, Toronto, Canada (1997).
66. Hohm, D. and G. Hes. *J. Acoust, Soc. Am. J* (1989) **85(1)**: 476 - 480.
67. Suzuki, K., K. Higuchi and H. Tanigawa, *IEEE Trans. Ultrason. Ferroelect. Freq. Contr* (1989) UFFC- **38**: 620 - 627.
68. Rafiq, M. and C. Wykes, *Measur. Sci. Technol* (1991) **2(2)**: 168 - 174.

69. Haller, M.I, B. T. Land and Khuri Yakub, *Ultrasonics Symp.*, Cannes, France (1994) 1241–1244.
70. Schindel, D. W., D. A. Hutchins, L. Zou, and M. Sayer, *IEEE Trans. Ultrason. Ferroelect. Freq. Contr* (1995) **42**: 42 - 50.
71. Ladabaum, I., B. T. Khuri Yakub, D. Spoliansky, and M. I. Haller, *Ultrasonics Symp*, Seattle, WA (1995) 501- 504.
72. Haller, M. I. and B. T. Khuri Yakub, *IEEE Trans. Ultrason. Ferroelect. Freq. Contr* (1996) **43**: 1 - 6.
73. Ladabaum, I., B. T. Khuri Yakub and D. Spoliansky, *Appl. Phys. Lett* (1996) **68(1)**: 7- 9.
74. Ladabaum, I., X. C. Jin, and B. T. Khuri Yakub, *Ultrasonics Symp.* Toronto, Canada (1997) 983 - 986.
75. Jin, X. C., I. Ladabaum and B. T. Khuri Yakub, *Int. Conf. Solid-State Sensors and Actuators*, Chicago, IL. (1997) 437- 440.
76. Eccardt, P., K. Niederer, T. Scheiter and C. Hierrold. *Ultrasonics Symp* San Antonio, TX (1996) 959–962.
77. Jin, X. C., I. Ladabaum, and B. T. Khuri Yakub, *IEEE/ASME J. Micro electromech. Syst* (1998) **7**: 295–302.
78. Ladabaum, I., X. C. Jin, H. T. Soh, F. Pierre, A. Atalar, and B. T. Khuri Yakub, *Ultrasonics Symp.*, San Antonio, TX (1996) 335–338.
79. Ladabaum, I., X. C. Jin, H. T. Soh, A. Atalar, and B. T. Khuri –Yakub, *IEEE Trans. Ultrason., Ferroelect., Freq. Contr* (1998) **45**: 678–690.

80. Jin, X. C., I. Ladabaum, and B. T. Khuri Yakub, *IEEE Workshop on Micro electromechanical Systems*, Heidelberg, Germany (1999) 649 - 654.
81. Atalar, A., *IEEE Trans. Ultrason., Ferroelect., Freq. Contr* (1988) **35** : 612–617.
82. Russell, S. J. and N. Mao, *AUTEX Research Journal* (2000) **1(2)**:47-53.
83. Starr, J. L. and R. Rowland, *52 SSSAJ* (2007) **71**: 51-52.
84. Baumhatdt, R.L., R.J. Lascano, and S.R. Evett, *Soil Sci. Soc. Am. J.* (2000) **64**:1940 -1946.
85. Buss, P., *Proc. Natl. Conf. Irrig and Drainage*, Launceston, Tasmania. Irrig. Assoc. of Australia, Homebush, NSW (1993).
86. Chanzy, A., J. Chadoeuf, J.C. Gaudu, D. Moharth, G. Richard and L. Bruckler, *Eur. J. Soil Sci* (1998) **49**:637–648.
87. Evett, S.R., B.B. Ruthardt, S.T. Kottikamp, T.A. Howell, A.D. Schneider, and J.A. Tolk, *Trans. 17th World Congress of Soil Science*, Bangkok, Thailand (2002) 3181–3188.
88. Fares, A and A.K. Alva, *Irrig. Sci* (2000) **19**:57- 64.
89. Fares, A and A.K. Alva. *Soil Sci. Soc. Am. J* (2000) **64**:311 - 318.
90. Groves, S.J and S.C. Rose, *Soil Use Manage* (2004) **20**:96 - 97.
91. Kelleners, T.J., R.W.O. Soppe, J.E. Ayars, and T.H. Skaggs, *Soil Sci. Soc. Am. J* (2004) **68**:770 - 778.
92. Morgan, K.T., L.R. Parsons, T.A. Wheaton, D.J. Pitts, and T.A. Obreza, *Soil Sci. Soc. Am. J* (1999) **63**:987- 989.

93. Paltineanu, I.C., and J.L. Starr, *Soil Sci. Soc. Am. J* (1997) **61**:1576 - 1585.
94. Starr, J.L., and I.C. Paltineanu, *Soil Sci. Soc. Am. J* (1998) **62**:114 -122.
95. Starr, J.L., and I.C. Paltineanu, *Capacitance devices. In* J.H. Dane and G.C. Topp (ed.) *Methods of soil analysis. Part 4. SSSA Book Ser. 5.* SSSA, Madison, WI (2002) 463 - 474.
96. Herve´ BolvinN, Andre´ Chambarel, and Andre´ Chanzy, *Soil Sci. Soc. Am. J* (2004) **68**:440 - 446.
97. Evett, S.R., and J.L. Steiner, *Soil Sci. Soc. Am. J* (1995) **59**:961- 968.
98. Chanzy, A., J. Chandocuf, J.C, Gaudu, D. Mohrath, G. Richard, and L. Bruckler, *Eur. J. Soil Sci* (1998) **49**: 637- 648.
99. Straub, A., *IEEE Trans. Geosci. Remote Sens* (1994) **32**:261 – 266.
100. Currie, P.O., T.O. Hilken, and R.S. White, *J. Range Manage* (1987) **40**: 537- 541.
101. Calvert, J.M and Mc Causland, M.A.H., *Text Book of Electronics*, John Wiley & Sons, New York (1978) 12-19.

CHAPTER FOUR

Near IR Spectral Response of Natural Rubber Latex in the Reflectance Mode

4.1: Introduction

The near Infrared (NIR) region of the electromagnetic spectrum extends from the upper wavelength end of the visible region at about 770 nm to 2500 nm (13,000 to 4000 cm^{-1}). Absorption bands in this region are overtones or combinations of fundamental stretching vibrational bands that occur in the region of 3000 cm^{-1} to 1700 cm^{-1} . The bonds involved are usually C-H, N-H and O-H¹⁻². Near-Infrared Reflectance Spectroscopy (NIRS) is an important tool in chemical analysis³. It is a secondary technique to obtain primary patterns (a calibration set) to analyze substances⁴. NIRS can be used in a laboratory for routine scanning of samples, but continual monitoring is necessary to ensure accurate results. This system for monitoring is detailed by Shenk et al⁵. Traditionally, NIRS has been used to determine the composition of agricultural products, but today, it is also used in other areas, such as the oil industry, pharmaceuticals, polymers, food industry, and clinical

laboratories⁶. NIRS also has many advantages over traditional methods in that it does not use chemical reactants and, thus, does not pollute the environment⁷. Use of NIRS in chemical analysis has grown due to development of computers and specific softwares in analytical techniques and statistical tools⁸. Near-infrared (NIR) techniques are quite suitable for short wavelength (near NIR) range applications because of the inexpensive optical sensors available today. Its other advantages include speed, simplicity, and simultaneous measurement of a number of constituents⁹.

In addition to the chemical composition of materials, near infrared spectra are also influenced by the physical structure of material. The size and shape of the particles, the voids between particles and the arrangement of particles affect the extent of light transmission through a sample and thereby influence the reflectance¹⁰. Near infra red reflectance spectroscopy is a non-destructive analytical technique for studying interactions between incident light and a material surface¹¹. The technique was first developed more than three decades ago for rapid moisture analysis of grains¹². Now NIRS is the dominant analytical technique used for grain and forage quality assessments. Near – infrared reflectance spectroscopy is also used as an identification and/or characterization technique in polymer and related industries¹³⁻¹⁵.

Near-infrared (NIR) diffuse reflectance spectroscopy involves the illumination of a spot on the sample with NIR light (750–2500 nm). The light is partially absorbed and partially scattered, depending upon its interaction with chemical components within the tissue, before being reflected back to a

detector¹⁶. The instrumental setup and basic principle of the method is similar to that of the double-sphere method, developed by Van den Akker¹² et al. in 1966 and later refined and applied to establish the NIST (National Institute of Standards and Technology) reflectance scale¹⁷⁻¹⁸.

Keyworth (1961) first demonstrated the analytical utility of NIR spectroscopy for measurement of water in organic solvents, since water strongly absorbs NIR radiation with a large absorption band centered at 5200 cm^{-1} . A band of NIR radiation is passed through the sample of interest, and the amount of water present is calculated based on the absorbance of 5200 cm^{-1} radiation. Venz and Dickens (1989) also used NIR spectroscopy to follow and quantify water uptake in various resin composite restorative materials.

In this work, our objective is to develop a method to determine the DRC of rubber latex, which measures the variation of the NIR absorption in the reflectance mode. This method is found to be accurate, fast, inexpensive, user-friendly and adaptable to varying environmental conditions. The correlation of NIR absorption with DRC is established and discussed.

4.2: NIR spectroscopy in agriculture and food sciences

Ben-Gera and Norris¹² first described the potential of near-infrared reflectance (NIRS) spectroscopy as a technique for routine quantitative analysis of agricultural products. The technique has extensive applications for the analysis of constituents of agricultural crops, feeds, and foods¹⁹⁻²³. Its

ability to accurately predict yield of field crops such as soybean or maize (*Zea mays* L.) allows producers, economic agencies, and buyers to make decisions with respect to crop management, pricing and available markets²⁴. Infrared (IR) reflectance can provide an instantaneous, nondestructive, and quantitative assessment of the crop's ability to intercept radiation and photosynthesis²⁵. The input of reflectance into yield production models has been shown to improve yield estimates²⁶⁻²⁷.

The amount of reflectance in the near IR (NIR) range is determined by the optical properties of the leaf tissues: their cellular structure and the air–cell wall–protoplasm–chloroplast interfaces²⁸. This technique is also used for measuring the content of glucose in water and protein matrix. Infrared technique is used for measuring glutamine, ammonia, lactate and glutamate in aqueous solutions simultaneously²⁹⁻³¹. The most widespread use of this technique has been for the determination of protein, moisture, starch, oil, lipids and cellulose in agricultural products such as grains and oil seeds³².

Previous work has demonstrated the potential of NIR spectroscopy as a tool for the rapid evaluation of detergent fiber, total dietary fiber, and the components of dietary fiber in wheat bran mixtures, oat bran and diverse cereal products³³⁻³⁹. NIR spectroscopy has also been investigated as a tool for the evaluation of barley protein and moisture content and for the quality evaluation of malt⁴⁰⁻⁴².

The NIR spectroscopy has been used to measure the contents of various constituents in dairy products such as milk, skim milk, milk powder,

whey and cheese⁴³⁻⁵⁴. The NIRS is also used for the determination of soil carbon⁵⁵⁻⁵⁹, levels of ergovaline in tall fescue⁶⁰, alkaloids and phenolics in green tea⁶¹, phosphorus in sugarcane Leaves⁶², vitamin content, carbohydrates and fats⁶³.

4.3: NIR spectroscopy in medical and dental sciences

Combined with advanced data processing techniques, chemometric analysis and fiber optic technologies, NIR spectroscopy has been applied to biomedical fields and has demonstrated a substantial potential for diagnosing diverse clinical diseases⁷⁰⁻⁷¹. NIR spectroscopy is also an alternative method for measurement of water sorption by dental materials⁷².

NIRS is a continuous, noninvasive bedside technique that can be used to monitor cerebral oxygenation⁷³⁻⁷⁵, for conducting observational study during carotid endarterectomy⁷⁶, determination of thresholds for severe cerebral ischaemia during carotid surgery, measurement of cerebral blood volume⁷⁷⁻⁷⁸, blood flow index⁷⁹, blood flow and oxygen consumption⁸⁰, noninvasive prediction of glucose in blood / tissue⁸¹⁻⁸³, and detection of lipid pool, thin fibrous cap, and inflammatory cells in human aortic atherosclerotic plaque⁸⁴.

Near infra red reflectance spectroscopy (NIRS) is capable of rapidly determining various chemical parameters of forages with a high degree of accuracy⁸⁵⁻⁸⁷. NIRS has been successfully used to measure the composition



and quality of single species⁸⁸⁻⁸⁹ and mixed species forages⁹⁰⁻⁹² as well as to determine animal response⁹³.

4.4: Near Infrared absorption by molecules

Absorption of light by a sample at specific wavelengths is a characteristic property of the sample. The specific wavelengths absorbed by a sample are determined by the electronic, vibrational and/ or rotational energy levels of the atomic and /or molecular species present in the sample. In the normal transmission mode one can apply the Beer- Lambert law to determine the concentration of a specific analyte in the sample at a specific wavelength, given by⁹⁷.

$$A = \epsilon IC \quad \dots\dots 4.1$$

where, at a specific wavelength, A is the measured absorbance, ϵ is the molar absorption or the extinction coefficient ($M^{-1}cm^{-1}$), l is the path length (cm) and C is the analyte concentration. The relationship between Absorbance and Transmittance T is given by⁹⁷

$$A = - \log T \quad \dots\dots 4.2$$

The Beer – Lambert law describes a linear relationship between absorbance and concentration. The absorbance or transmittance in a sample can be measured in the normal transmission mode of a UV-Vis-NIR Spectrophotometer under normal circumstances.

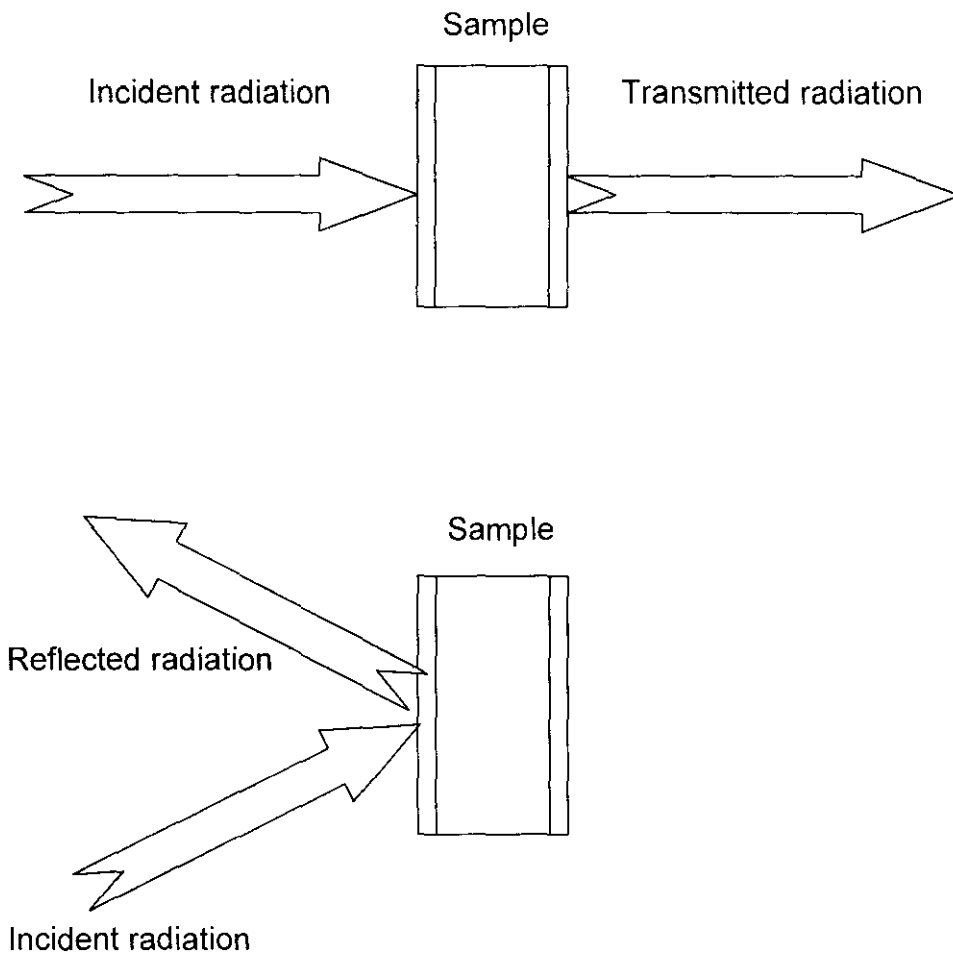

Fig 4.1: Through transmission and reflection modes of experimental set up

In addition to the normal transmission mode mentioned above, a UV-Vis-NIR Spectrophotometer can also be used to measure the reflectance of materials. Normal transmission and reflectance modes of measurement are demonstrated in fig. 4.1. Reflectance refers to the intensity of light reflected

from the surface of a sample when light is incident at an angle larger than the critical angle for the sample. Reflectance at a specific wavelength carries the same information as the transmittance in the normal absorption mode. Reflectance intensity is obtained by subtracting the absorbed intensity from the incident intensity. It is much more convenient and accurate to measure absorbance in the reflectance mode from samples that are highly absorbing or scattering.

A diffuse reflectance spectrophotometer is similar to a standard UV-Vis-NIR Spectrophotometer, which can provide a bandwidth narrow enough to record well resolved spectra, yet wide enough to cover the energy levels of interest for the sample under test. A reflectance spectrophotometer must also have necessary optics and electronic systems of high sensitivity, and should be able to physically accommodate the reflectance accessories. Moreover, the instrument should have capability to measure reflectance as the wavelength is varied.

4.5: Experimental Method

First, we tried to record Near Infrared absorption spectra of natural rubber latex samples using a Varian Make Carry 5000 UV-Vis-NIR spectrophotometer in the normal absorption mode. It was noticed that the absorbance is very high throughout this spectral range and it was not possible to resolve any of the features of the absorption spectra in this mode. Then the

absorption spectrum in the same wavelength range was recorded in the reflectance mode utilizing the Internal Diffuse Reflectance Attachment Model DRA 2500 attached to the same spectrophotometer. The latex samples were taken in rectangular quartz cuvettes for these measurements. The reflectance spectra were recorded for several fresh latex samples. The spectra of the same samples diluted with different percentages of water were also recorded to understand the effect of dilution on the reflectance intensity.



Fig 4.2 Photograph of Varian Make Cary 5000 UV-Vis-NIR Spectrophotometer

We have used a Varian Make Cary 5000 UV-Vis-NIR Spectrophotometer for conducting NIR reflectance studies on latex samples.

The spectrophotometer combines with PbS smart technology extending the wavelength range into the NIR up to 3300 nm. The Carry 5000 spectrophotometer can be used for a range of applications from quantifying out-of-band blocking characteristics of band pass filters to measuring the high transmission of next generation fiber optic materials. The Carry 5000 UV-Vis-NIR spectrophotometer is having a wavelength range from 175 to 3300 nm and floating aluminum casting for isolating the optics from external disturbances. The PbS NIR detector used in this instrument provides excellent signal to noise ratio and linearity for the instrument in the NIR region. The Schwarzschild coupling optics employed in the instrument provides maximum level of light throughput for more accurate measurements at low transmission levels. The silica overcoating protects the optical system of the instrument from the environment and allows cleaning the reflective surface without any damage to it. The spectrophotometer is equipped with variable and fixed slit arrangements for optimum control over data resolution and the spectral bandwidth can be set down to 0.01 nm. The slits can be fixed in the NIR as well as the UV - Vis regions. The photometric noise and the effect of stray light are optimized for excellent resolution using out-of-plane double Littrow monochromator. The other feature of the Carry 5000 spectrophotometer is the advanced electronics system which can measure the absorbance beyond 8 Abs with reference beam attenuation. The spectrophotometer has separate nitrogen gas purge facility for monochromator and sample compartments for creating a neutral atmosphere

during analysis. The lamps used in the instrument can be easily replaced and are pre aligned requiring no adjustment. The lamp management electronic ensures that a wide range of design can be accommodated.

Extending the PbSmart™ technology from the Cary 5000, the PbS NIR detector is Peltier cooled and optimized in real time. This PbSmart technology extends the performance of traditional PbS detectors. With Varian's Lock-down™ lever for installing accessories, one doesn't need any tools, saving time. An internal DRA can be used with all of Varian's high end UV instruments, so as to choose the detector options that best suit the needs. Sample mounting options are provided as standard for the instrument. The liquid sample holder is ideal for measuring the transmission of liquid samples. It holds a standard 1 cm path length cuvette and mounts on the standard poles. It can be placed over both the transmittance or reflectance port of the internal DRA. When mounted in the reflectance position, it can be used to measure the reflectance of powdered samples as well. The powder cell holder allows for reflectance measurement of powder and paste samples. It fits in the small sample holder and is mounted on the reflectance port of the internal DRA. This kit contains a pre-packed PTFE cell for use as a reflectance standard, a powder cell holder for sample measurement, a funnel for easy loading of powdered sample and small sample holder. Each cell has a quartz window and can be used to measure samples across the 200-2500 nm wavelength range. The powder cell holder is "plunger" operated allowing it to

accommodate a range of sample volumes, making it ideal for measuring small amounts of sample. The minimum practical volume is approximately 100 mm³ (which equates to a depth of 1 mm), and the maximum volume is approximately 1 cm³. However, this is dependent on the particle size and opacity of the sample. The double aperture attachment is used in conjunction with the Cary Win UV Validate software to measure the photometric accuracy of the system. The double aperture attachment mounts onto the polarizer mount which comes standard with the internal DRA.

The latex samples for all the experiments described in this work, were collected from the Experimental Farm of Rubber Research Institute of India, Kottayam, Kerala, India. The essential details of the trees from which latex samples were collected are: Clone: RR11 105, Year of planting: 1989-93, D₃ tapping system). Samples with wide variations in DRC were collected for measurement. During sample collection 10-15 ml of each sample is collected in two separate containers to determine their DRC values following the standard laboratory drying procedure (gravimetric method) and from reflectance measurements, as outlined above.

4.6: Treatment with adulterants

The DRC of latex forms the basis of payments to producers and hence its accurate estimation is very important from a commercial point of view. Comprehensive list of adulterants or treatments which have been used in

practice is not available, through several have been postulated by different latex buyers³⁸. It is rather difficult to prove the use of adulterants in latex as latex buyers find it difficult to separate the effect of adulterants from lower DRC values of latex. So, even though use of adulterants is not proved beyond doubts, latex buyers are always concerned about the possible use of adulterants in latex. In this work we have carried out a systematic study with five suspected adulterants, viz. coconut water, saturated salt solution, rice effluent, rice water and ground water added to natural rubber latex. Latex samples have been treated with three known concentrations (25 %, 50 %, and 75 %) of each adulterant and their reflectance measured using the UV-Vis-NIR spectrophotometer fitted with Internal DRA.

4.7: Results and Discussion

Spectral reflectance data have been recorded in a series of measurements on different sets of samples. The variations of the reflectance values for different latex samples as a function of wavelength in the region 1425 nm to 1500 nm are shown in Figure 4.3. The spectral responses beyond this region are not shown because they are not of any interest for the results presented in this work. It can be noted that the absorbance is maximum or reflectance is minimum at 1460 nm. The variation of the percentage reflectance at 1460 nm for different latex samples with the corresponding DRC values, measured following the laboratory drying method, is tabulated in Table

4.1, with the corresponding variation drawn in Fig. 4.4. The results are analyzed using statistical tools and it is found that reflectance and the % DRC values, as shown in Table 4.1 as well as Figure 4.4, possess a correlation better than 0.95.

The reflectance values from latex samples after dilution with different adulterants are tabulated in Table 4.2. Figures 4.5 to 4.9 show the reflectance of latex samples diluted with different adulterants. Treatment of latex samples with adulterants show that the reflectance decreases with increase in the concentration of adulterants and thus no financial advantage would accrue by doing this, if the DRC values are measured following this technique. Measurements indicate that addition of adulterants would show up as a decrease in DRC values. Uncertainties in these measurements have been estimated from repeated measurements on the same sample. The estimated uncertainties are ± 0.6 %, with a coverage factor of 2, at a confidence level of 95 %.

The very purpose of this work is to see whether there is a relation between optical absorption and the DRC values of rubber latex. The spectral reflectance measurements with the internal DRA of a high resolution UV-Vis-NIR Spectrophotometer have shown that latex sample absorbs infrared radiation strongly around 1460 nm, which is due to the water molecules present in the latex. The reflectance intensity from the sample decreases with the increase of water content in the latex, and hence it is proportional to the dry rubber content of the latex.

Fig. 4.3: Reflectance spectra of different latex samples

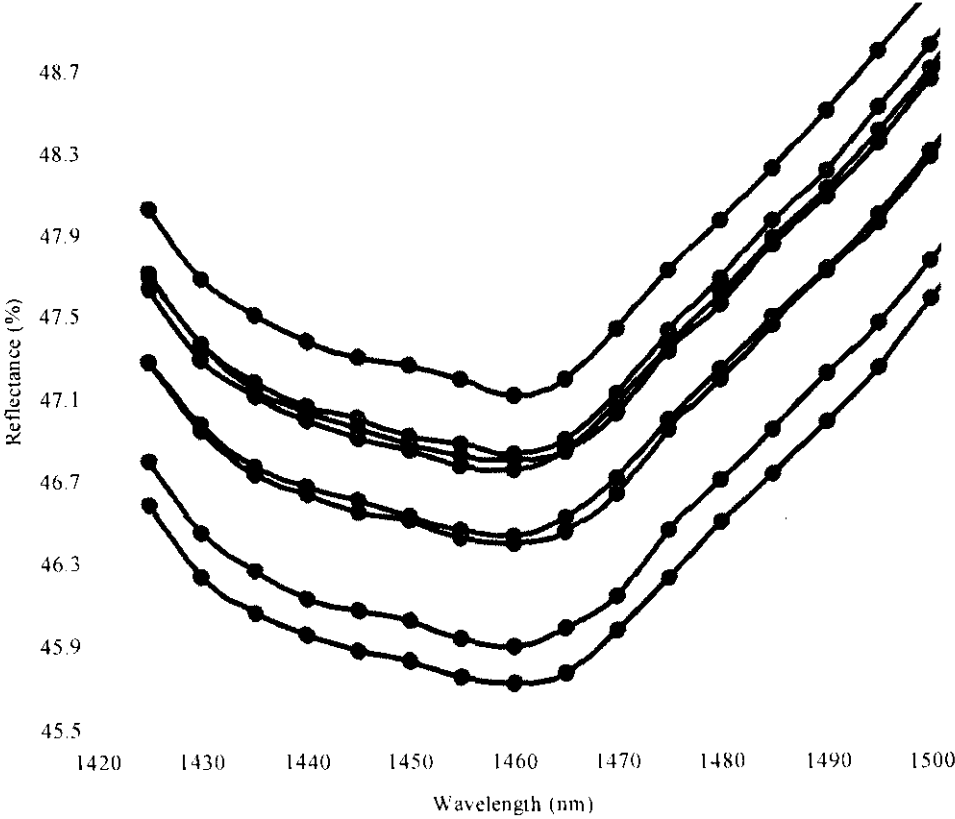

Table 4.1: Percentage Reflectance values in the Near IR region at 1460 nm for samples with different DRC values (measured by gravimetric method).

Serial No.	DRC (%) laboratory drying method ($\pm 0.5\%$)	NIR Reflectance (%) ($\pm 0.8\%$)
1	34.45	45.90
2	34.82	45.75
3	35.05	45.90
4	35.81	45.79
5	36.39	45.83
6	37.34	46.21
7	38.61	46.03
8	39.28	46.33
9	41.51	46.27
10	44.35	46.89
11	44.77	46.86
12	44.89	46.91
13	46.43	46.74
14	48.64	46.94
15	48.74	47.27

Fig 4.4: Variation of % Reflectance with % DRC at 1460 nm in different latex samples

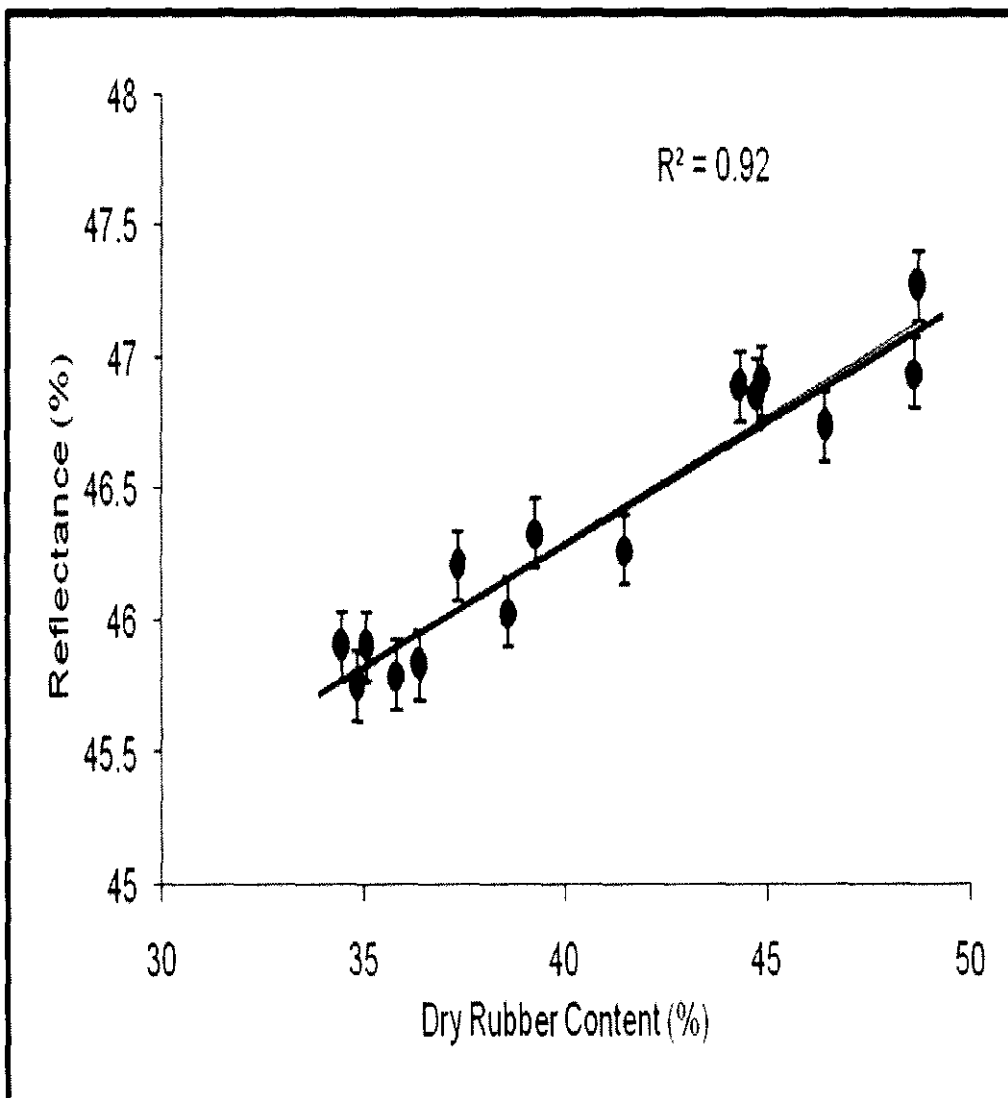

Table 4.2: Reflectance values of latex samples after dilution with different adulterants

Name of Adulterant	No. of treatment	Reflectance (%) at wavelength 1460 nm				
		R ₁	R ₂	R ₃	R ₄	R ₅
A ₁	T ₁	32.62	34.12	47.08	47.34	48.13
	T ₂	32.23	33.89	47.29	47.48	48.47
	T ₃	31.37	32.12	46.70	46.57	47.84
	T ₄	28.05	28.29	43.90	44.33	45.29
A ₂	T ₅	32.15	31.90	46.93	47.79	48.28
	T ₆	30.94	31.30	45.86	46.58	47.45
	T ₇	28.37	30.29	43.18	44.77	45.18
A ₃	T ₈	31.86	33.08	46.80	47.68	47.90
	T ₉	30.41	31.13	45.63	46.53	46.51
	T ₁₀	27.87	27.88	42.47	44.01	43.85
A ₄	T ₁₁	31.71	33.33	47.18	48.22	48.23
	T ₁₂	31.16	32.11	46.58	47.64	47.53
	T ₁₃	28.44	28.89	43.82	43.86	44.64
A ₅	T ₁₄	32.03	32.43	47.34	47.34	48.33
	T ₁₅	31.16	31.73	46.63	45.89	47.86
	T ₁₆	28.10	28.47	43.93	43.36	45.56
DRC (%) of unadulterated samples		38.65	39.00	43.17	43.58	44.35

A1 – ORDINARY WATER, A2 – COCONUT WATER, A3 – SATURATED SALT SOLUTION, A4 – RICE WATER, A5 – RICE EFFLUENT. R₁- R₅: Number of replications, T₁ : Unadulterated latex samples, T₂ – T₁₆ : latex samples treated with adulterants. T₂, T₅, T₈, T₁₁, T₁₄: 25%, T₃, T₆, T₉, T₁₂, T₁₅: 50%, T₄, T₇, T₁₀, T₁₃, T₁₆ : 75 %.

Fig 4.5: Variation of % Reflectance at 1460 nm diluted with ordinary water (in %) to latex.

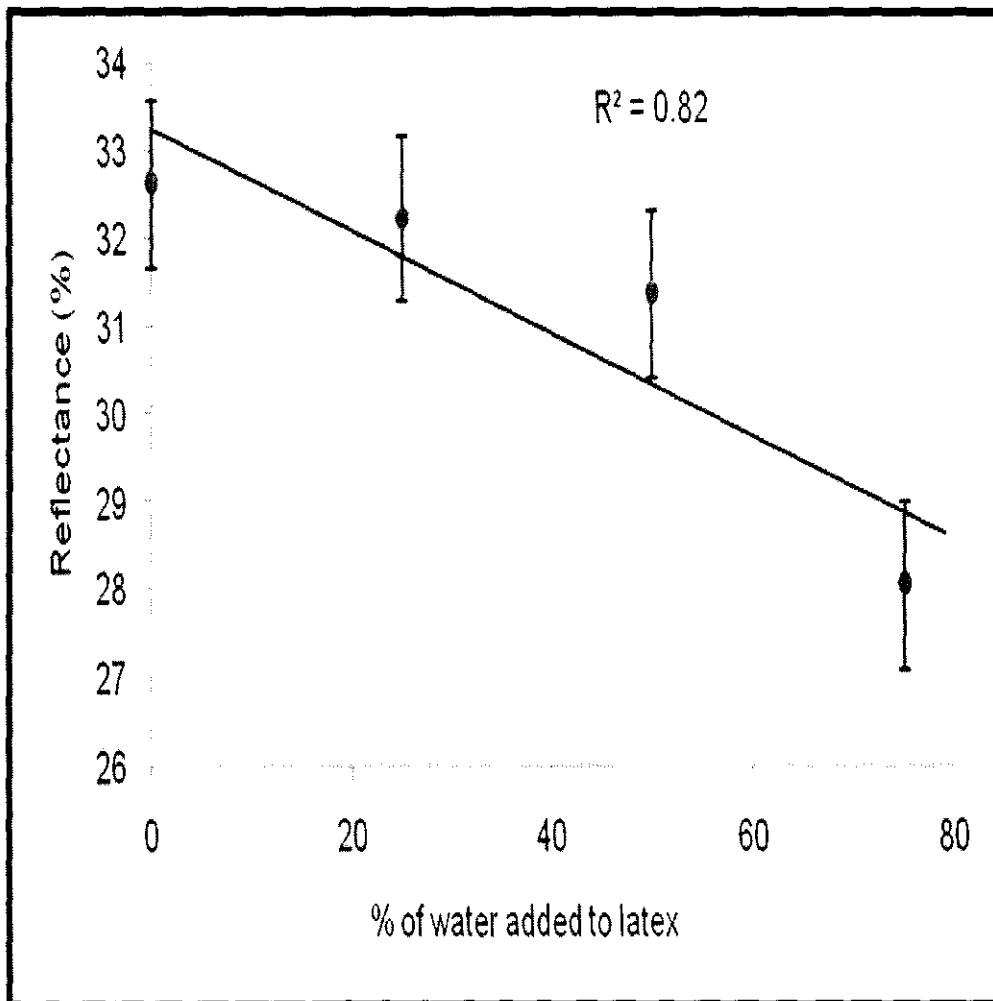

Fig 4.6: Variation of % Reflectance at 1460 nm diluted with % coconut water (in %) to latex.

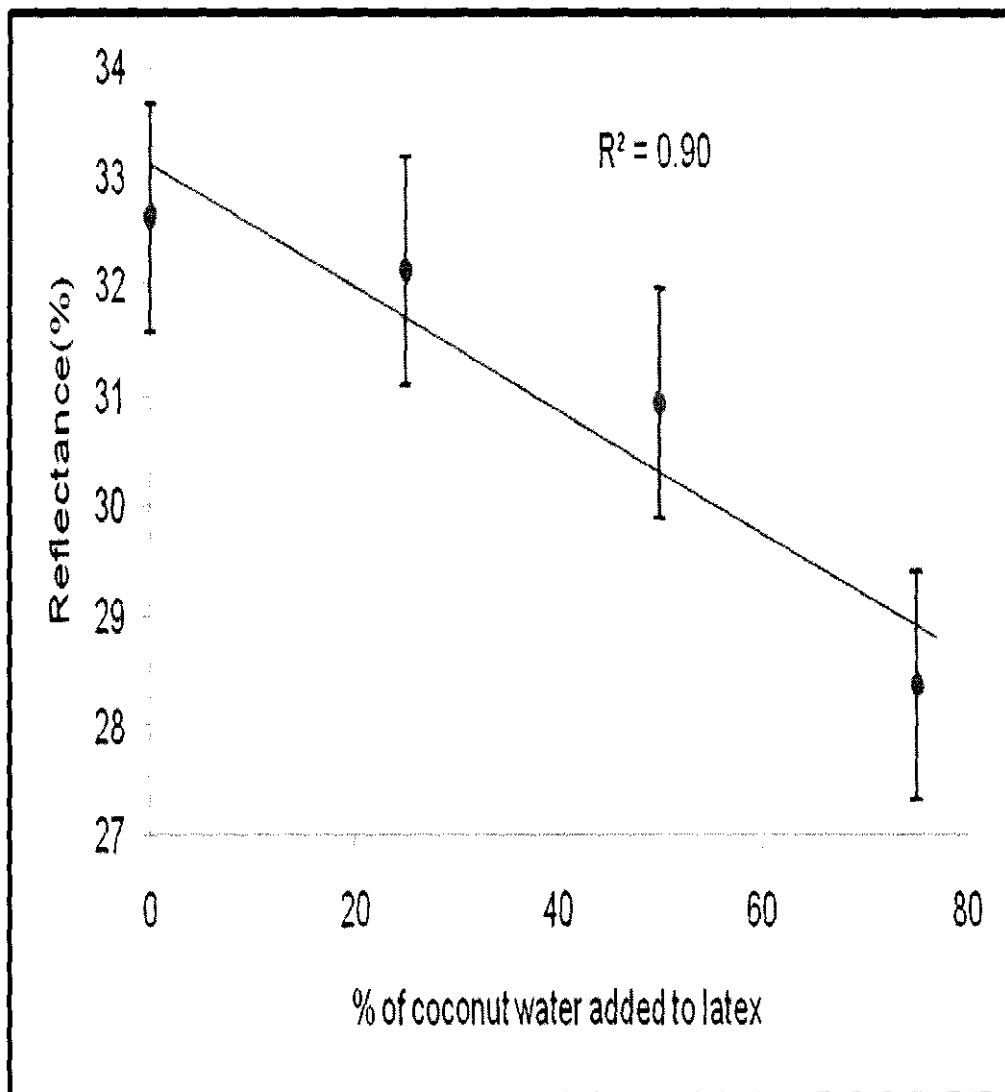

Fig 4.7: Variation of % Reflectance at 1460 nm diluted with saturated salt solution (in %) to latex samples.

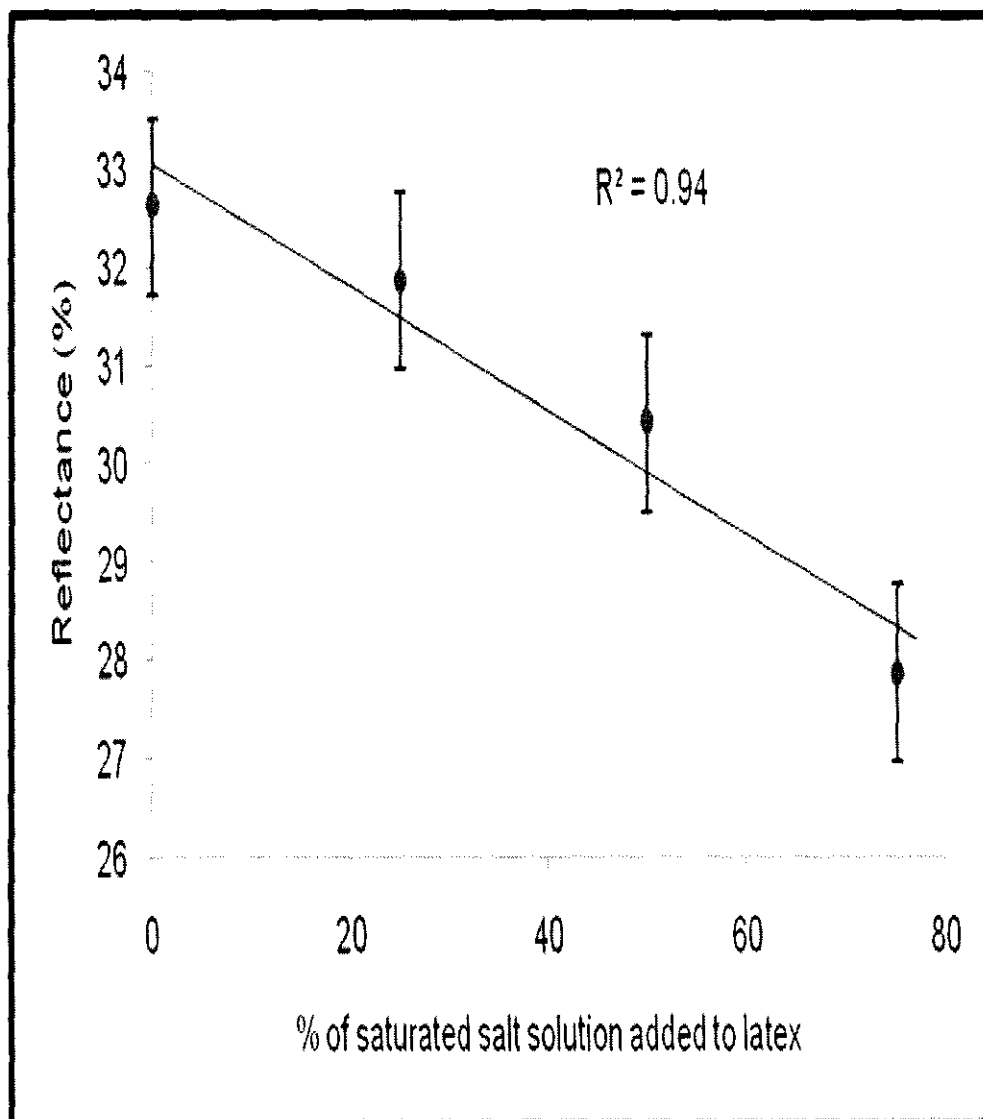

Fig 4.8: Variation of % Reflectance at 1460nm diluted with rice water (in %) to latex samples.

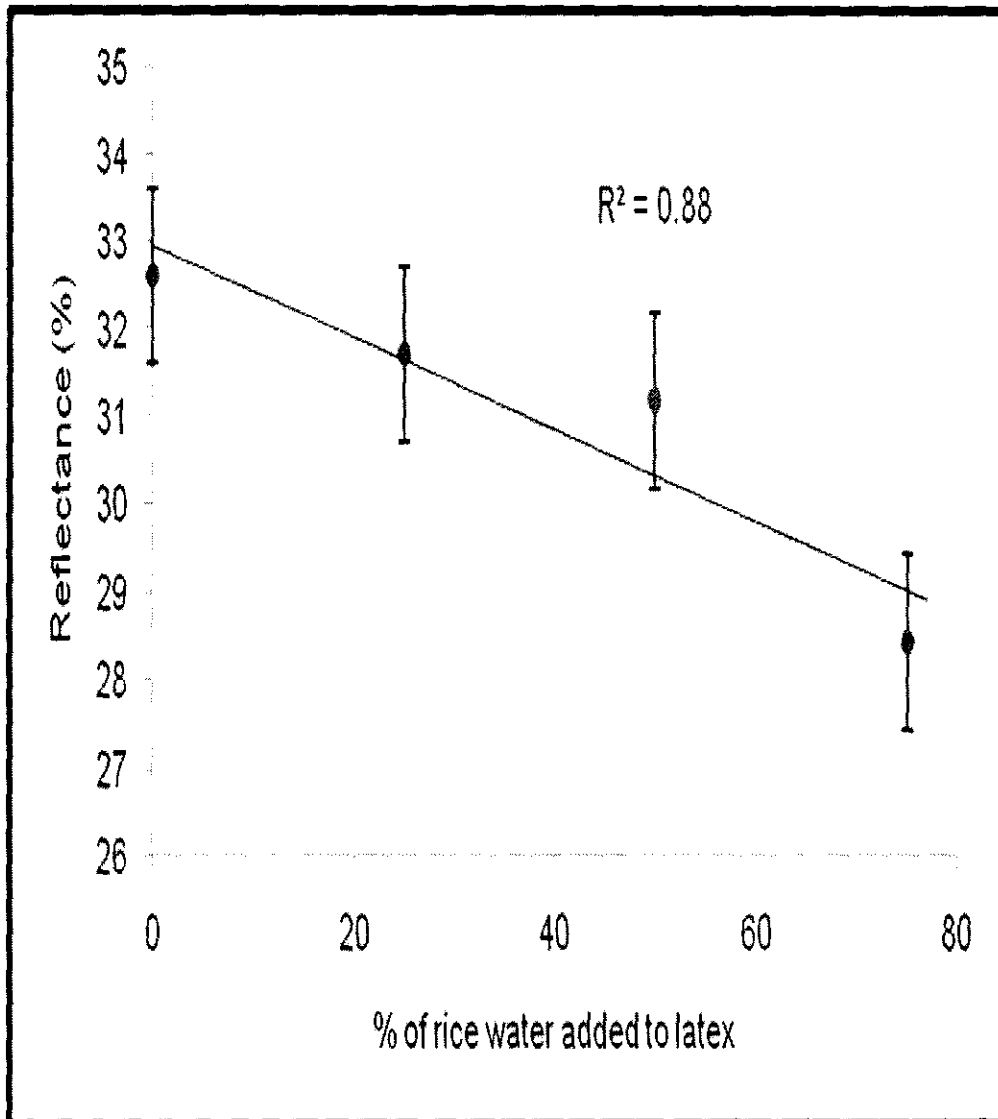
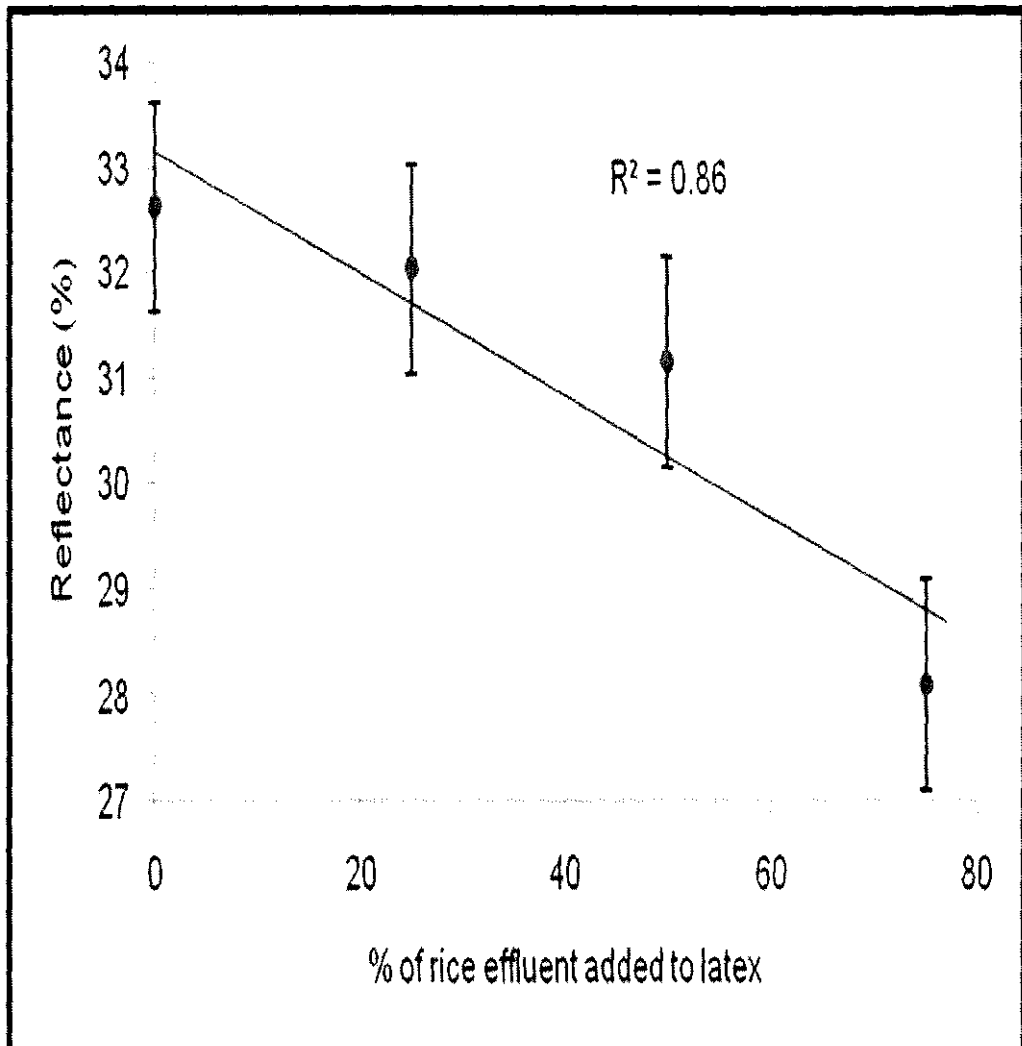

Fig 4.9: Variation of % Reflectance at 1460 nm diluted with (in %) rice effluent to latex samples.



4.8: Conclusions

We have been able to establish a good correlation between % DRC and reflectance of natural rubber latex samples in the near infrared region. It is found that water molecules in the latex selectively absorb near infrared radiation at specific wavelengths, which can be used as a technique to estimate the DRC of natural rubber latex. Though we have been able to establish the relationship between % DRC and % reflectance from latex, we have not been able to bring out the influence of non rubber constituents on reflectance in these measurements. The reflectance of latex with different concentrations of adulterants decreases with the increase in concentration of the adulterant. Since the major contents of adulterants are again water, we anticipate the reflectance values to decrease correspondingly with the addition of such adulterants.

Based on the results obtained from the infrared absorption studies we estimate that a viable DRC measurement system following this technique will have measurement uncertainties in the range of $\pm 1\%$ due to various factors. Measurement uncertainties can be further reduced by improving the signal to noise ratio by increasing the radiant power, optimizing the detection electronics and measurement procedures.

References

1. Burns, D.R. and Ciurczak, Eds. New York: Marcel Dekker (1992).
2. Mc Clure, *Anal. Chem.*, (1994) **66**: 43.
3. Shenk, J.S., and M.O. Westerhaus, *Forage Quality, Evaluation, and Utilization*, Madison (1994) 406 - 449.
4. Shenk, J.S., and M.O. Westerhaus, *Analysis of Agriculture and Food Products by Near Infrared Reflectance Spectroscopy*, Infracsoft International, Port Matilda, PA (1995).
5. Shenk, J.S., M.O. Westerhaus, and S.M. Abrams, Near Infrared Reflectance Spectroscopy (NIRS): Analysis of Forage Quality. *Agriculture Handbook*, USDA, Washington, DC (1989).
6. Hall, J.W., and A. Pollard, *Clin. Chem.* (1992) **38**:1623–1631.
7. Norris, K.H., Near Infrared Reflectance Spectroscopy (NIRS): Analysis of Forage Quality. *Agriculture Handbook*, USDA, Washington, DC (1989).
8. Moore, D.S., J.S.White, and B.A Harbin, *Anal. Chim. Acta* (1994) **294**:85 - 94.
9. Tsenkova, R., S. Atanassova, K. Toyoda, Y. Ozaki, K. Itoh and T. Fearn, *J Dairy Sci* (1999) **82**:2344 - 2351.
10. Wetzel, D.L., *Anal. Chem* (1983) **55**:1165 A - 1176 A.

11. Chen – Wen Chang, David A. Laird, Maurice J. Mausbach, and Charles R Hurburgh Jr, *Soil. Sci. Soc. Am J* (2001) **65**:480-490.
12. Ben –Gera, I., and K.H. Norries, *Isr. J. Agric, Res* (1968) **18**: 124 -132.
13. Craser, C.S and A.M.C. Davies, *Royal Soc. Chem*, (1988) 1-171.
14. Murray, L. and I.A Cowe, *Making light work: Advances in near infrared spectroscopy*, Weinheim, New York (1992).
15. Workman, J.J., *Appl. Spec. Rev* (1996) **31**: 251-320.
16. Van Den Akker, J. A., et al, *J. Opt. Soc. Am* (1966) **56**: 250-252.
17. Goebel, G. D., et al, *J. Opt. Soc. Am*, (1966) **56**: 783-788.
18. Venable, H.W. et al, *J. Res. Natl. Bur. Stand* (1977) **82**: 29-55.
19. Williams, P.C., and K.H. Norries, Near Infrared technology in the agricultural and food industries. *American Association of cereal Chemists*, St. Paul, MN (1987).
20. Williams, P.C., Near Infra red technology in the agricultural and food industries, 2nd edition, *Am. Asso. Of cereal chemists*, St. Paul. MN (2001).
21. Martin, G.C., J.S. Shenk, and F.E. Barton, Near infrared reflectance spectroscopy (NIRS): Analysis of forage quality. *USDA Agri. Hand book 643*, US. Govt. Print. Office, Washington DC (1989).
22. Osborne, B.G., T. Fearn and P.H. Hindle, *Practical NIR Spectroscopy with applications in food and beverage analysis*. Longman Scientific and Technical, Harlow, UK (1993).

23. Roberts, C.A., J.Workman, Jr. and J.B. Reeves. *Agron. Monogr*, ASA, CSSA, and SSSA, Madison, WI (2004) 44.
24. Ma, B. L, Lianne M. Dwyer, Carlos Costa, Elroy R. Cober, and Malcolm J. Morison. *Agron. J* (2001) **93**:1227-1234.
25. Ma, B.L., M.J. Morrison, and L.M. Dwyer. *Agron. J* (1996) **88**:915 - 920.
26. Clevers, J., C. Buker, H.J.C. Van Leeuwen, and B.A.M. Bourman, *Remote Sens. Environ* (1994) **50**:161–170.
27. Clevers, J. *Remote Sens. Environ* (1997) **61**: 221-228.
28. Kumar, R., and L. Silva., *Appl. Optics* (1973) **12**: 2950-54.
29. Hazen KH, Arnold MA, Small GW, *Appl. Spectrosc* (1998) 52: 1597-1605.
30. Marquardt, L.A., Arnold, M.A., Small, G.W., *Anal Chem* (1993) **65**:3271-3278.
31. Chung H, Arnold MA, Rhiel M, Murhammer, D.W., *Appl Spectrosc* (1996) **50**:270-276.
32. Reeves, J.B. and C.M. Zapf., *J. Agric. Food Chem* (1998) **46**:3614 - 3622.
33. Baker, D., *Cereal Chem* (1983) **60**: 217-219.
34. Horvath, L., K.H. Norries, M. Horvath – Masonyi, J. Rigo, and E. Hegedus – Volgesi, *Acta Aliment* (1984) **13**: 355-382.
35. Williams, P.C., H.M. Cordeiro, and M.F.T.Harnden, *Cereal foods world* (1991) **36**: 571-574.

36. Kays, S.E., W.R. Windham, and F.E. Barton, *J. Agric. Food Chem* (1996) **44**: 2266 - 2271.
37. Kays, S.E., W.R. Windham and F.E. Barton, *J. Agric. Food Chem* (1998) **46**: 854 - 861.
38. Kays, S.E and F.E. Barton, *J. Agric. Food Chem* (2002) **50**: 3024-3029.
39. Archibald, D.D and S.E. Kays, *J. Agric. Food Chem* (2001) **48**: 4477 – 4486.
40. Angelino, S.A.G.F, *MBAA Tech. Quart* (1986) **33**: 170 -172.
41. Henry, R.J., *J. Inst. Brew* (1985) **91**: 393 – 396.
42. Lu, M.Q, L.O' Brien and I.M. Stuart, *Aust. J. Agric. Res.* (2000) **51**: 247 - 258.
43. Baer, R. J., J. F. Frank, and M. Loewenstein, *J. AOAC* (1983) **66**:858 - 863.
44. Baraba'ssy, S. P and S. Turza, *Near Infrared Spectroscopy: The Future Waves*. A.M.C. Davies and P. Williams, ed. NIR Publ, Chichester, United Kingdom (1996) 611–616.
45. De Boever, J. L., G. Huyghebaert, C.H. Boucq and G. De Groote, *Proc. 3rd Int. Conf, Near Infrared Spectrosc* (1990) 279.
46. Dy'az-Carrillo, E., A. Munoz-Serrano, A. Alonso-Moraga, and J.M. Serradilla-Manrique, *J. Near Infrared Spectrosc* (1993) **1**:141-146.
47. Pierce, M. M. and R. L. Wehling, *J. Agric. Food Chem* (1994) **42**:2830 - 2835.

48. Pouliot, M., P. Paquin, R. Martel, S. F. Gauthier, and Y. Pouliot, *J. Food Sci* (1997) **62**:475–478.
49. Saputra, D., F. E. Payne, R. A. Lodder, and S. A. Shearer, *Trans ASAE* (1992) **35**:1597–1605.
50. Sato, T., S. Kawano, and M. Iwamoto, *J.Dairy Sci* (1990) **73**:3408 - 3413.
51. Sato, T., M. Yoshino, S. Farukawa, Y. Someya, N. Yano, J. Uozumi, and M. Iwamoto, *Jpn. J. Zootech. Sci* (1987) **58**:698 -706.
52. Wittrup, C., and L. Norgaard, *J. Dairy Sci* (1998) **81**:1803–1809.
53. H. M. Al-Quadiri, et al, *J Dairy Sci* (2008) **91**: 950 - 958.
54. S. Sivakesava and J. Irudayaraj, *J. Dairy Sci* (2002) **85**: 487-493.
55. Dalal, R.C. and R.J. Henry, *Soil Sci. Soc. Am. J* (1986) **50**:120–123.
56. Meyer, J.H., *S. Afr. Tydskr. Plant Grond* (1989) **6**:59–63.
57. Janik, L.J. and J.O. Skjemstand, *Aust. J. Soil Res* (1995) **33**:637-650.
58. Reeves, J.B., G.W. McCarty, and J.J. Meisenger, *J. Near Infrared Spectrosc* (1999) **7**:179–193.
59. Reeves, J.B., G.W. McCarty, and V.B. Reeves, *J. Agric. Food Chem* (2001) **49**:766–772.
60. Roberts, C.A., R.E. Joost, and G.E. Rottinghaus, *Crop Sci* (1997) **37**: 281–284.
61. Schulz, H., et al, *J. Agric. Food Chem* (1999) **47**:5064–5067.
62. Ming Chen, et al, *Agron. J* (2002) **94**:1324–1331.

63. Pires, F. F., M. C. Lemos, J. C. Petersen and A. M. Kessler, *J. Appl. Poult. Res* (2001) **10**:412–418.
64. Jing Wang, et al, *Journal of the American College of Cardiology* (2002) **39(8)** : 1305-1306.
65. Hiroshi Shitomi and Ichiro Saito. *National Metrology Institute of Japan (NMIJ), National Institute of Advanced Industrial Science and Technology Ibaraki, JAPAN. p1.*
66. Wetzel, D.L., *Anal. Chem* (1983) **55**:1165 A – 1176 A.
67. H.W. Venable, et al, *J. Res. Natl. Bur. Stand* (1977) **82**: 29-55.
68. Watson, C., *Anal Chemistry* (1977) **49**: 835 A
69. Wetzel, D.L., *Anal Chemistry* (1983), **55**: 1165 A
70. Kirkpatrick, P J., Lam, J., Al- Rawi et al, *J Neurosurg* (1998) **89**:389–94.
71. Dempsey, R., Davis, D.G., Buice, R.G., and Lodder, R.A., *Appl. Spectroscopy* (1996) **50**:18A–34A.
72. A.M. Diaz-Arnold, M.A. Arnold, and V.D. Williams, *J Dent Res* (1992) **71(3)**: 438-442.
73. Timothy Lovelli, A., Huw Owen-Reece, Clare E. Elwell, Martin Smith, and John C. Goldstone, *Anesth Analg* (1999) **88** : 554.
74. Levy W.J, Levin, S and Chance, B., *Anesthesiology* (1995) **83**:738 – 46.
75. Mason PF, Dyson EH, Sellars V, Beard, J. D., *Eur J Vasc Surg* (1994) **8**:590-594.

76. Kirkpatrick PJ, Smielewski P, Whitefield PC, et al, *J Neurosurg* (1995) **82**:756–63.
77. Gupta, A.K, Menon, D.K., Czosnyka, M., et al, *Br J Anaesth* (1997) **78**:39 - 43.
78. Hopton, P., T. S. Walsh, and A. Lee, *J Appl Physiol* (1999) **87**: 1981-1987, 8750-7587/99.
79. Patrick Meybohm, et al, *Clay Minerals* (2000) **35 (5)**: 753-761.
80. De Blasi, R. A., M. Ferrari, A. Natali, G. Conti, A. Mega and A. Gasparetto, *Heart* (2006) **92**:1678-1685.
81. Jagemann K, Fischbacher C, Danzer K, Muller Ua and Mertes B. Z., *Phys Chem* (1995) **191**:179-190.
82. Stephen F. Malin, et al, *Clinical Chemistry* (1999) **45 (9)** : 1651–1658.
83. Malin S.F, Ruchti. T.L, Blank T.B, Thennadi, S.N and Monfre, S.L., *Clin Chem* (1999) **45**:1651-1658.
84. Pedro R. Moreno, et al, *Circulation* (2002) **105**:923-927.
85. Marten, G. C., et al, *Crop Sci* (1984) **24**:1179.
86. Marten, G. C., J. L. Halgerson and J. H. Cherney, *Crop Sci* (1983) **23**:94.
87. Norris, K. H., R. F. Barnes, J. E. Moore and J. S. Shenk, *J. Anita. Sci.* (1976) **43**:889.
88. Shenk, J. S., M. O. Westerhaus and M. R. Hoover, *J. Dairy Sci* (1979) **62**:807.
89. Burdick, D., F. E. Barton and B. D. Nelson, *Agric. J* (1981), **73**: 399.

90. Moe. A. J and S. B. Carr, *J. Dairy Sci* (1984) **67**:1301.
91. Bengtson, S and K. Larsson, *J. Sci. Food Agric* (1984) **35**:951.
92. Colerman, S. W., F. E. Barton, and R. D. Meyer, *Crop Sci* (1985) 25:834.
93. Eckman, D. D., J. S. Shenk, P. J. Wangsness, and M. O. Westerhaus, *J. Dairy Sci* (1983) **66**:1983.
94. Burns, D.R. and Ciurczak, *Handbook of Near Infrared Analysis*, Marcel Dekker, New York (1992).
95. Douglas A. Skoog, James Hollar, F and Timothy A., *Nieman Principles of Instrumental Analysis*, Harcourt Brace College Publishers, Chicago (1998) 422.
96. Rubber Research Institute of Malaysia, *Plrs" Bull* (1974) **130**: 21-29.

CHAPTER FIVE

Estimation of Dry Rubber Content in Natural Rubber Latex by Differential Scanning Calorimetry

5.1: Introduction

Differential scanning Calorimetry is a thermal analysis technique in which differences in heat flow into a substance and a reference are measured as a function of temperature while the two are subjected to a controlled temperature program¹. Such measurements provide qualitative and quantitative information about the physical and chemical changes involving endothermic or exothermic processes or changes in heat capacity of the sample. DSC technique generally covers the temperature range from -100°C to 1000°C with variable atmospheres². In this technique, the sample and reference are mounted on two separate pans which are heated with small (but powerful) heaters. The temperatures of the two pans are monitored by platinum resistance thermometers, with the two heater windings supplied with

variable current, so that both windings heat or cool the pans at the same rate, which can be up to 80°C/min. The power difference required for the two heaters to keep the sample and reference temperatures the same is measured (ΔH) and recorded as a function of the program temperature. This record shows the physical or chemical changes in the sample and the power difference is proportional to the thermal energy absorbed or released by any process. The technique presents an elegant method for investigating solid state phase reactions, phase transformations and inversions in compounds, for investigating reaction kinetics and phenomena associated with polymerization, thermal oxidative degradation, solvent retention, curing or drying properties of products etc³. DSC has developed into a very powerful thermal analysis technique today.

Differential scanning Calorimetry has been shown to be a valuable tool in studying ice in a variety of biological systems⁴. In DSC a number of overlapping transitions with a net endothermic effect are observed when microorganisms are heated⁵⁻⁹. Thermal analysis by thermo gravimetry and differential scanning calorimetry are widely applied to coal, charcoal, peat, and lignite¹⁰⁻¹² and also been used to assess humification of organic matter in whole soils, chemically extracted humic substances and composts¹³⁻¹⁶.

The differential scanning calorimetry is widely used for the study of lipids¹⁷⁻³⁸, phosphocholines¹⁸, lipoprotein²⁰, ice pre melting²¹, escherichia coli^{22, 23} cholesterol in gallstones²⁴, whey proteins^{25, 28}, lactoglobulin²⁷, Apo- α -lactalbumin³⁰, H – Hexane³¹, hydration zeolites³², polymers³³, effect of

insecticides in mango fruits³⁴, bornite – digenite^{35, 39} yeast and glucose³⁶, polyurethane elastomers³⁷, Alcohol⁴⁰, wool⁴¹, water status and cellulose^{42,43}, milk, fats, cheese^{44-47, 50,52}, fugally degraded wood⁴⁹, plasma proteome⁵⁰, and anticancer drug⁵³. The DSC is also used for research on food science²⁶, biochemistry and biology⁴⁸. The applications of DSC are numerous.

In the present DSC studies our objectives have been to see whether any physical relation exists between the DRC of latex and the change in enthalpy of the sample as it is heated over a defined temperature range measured by heat flux DSC technique and explore the possibility of developing a method to determine the DRC of latex based on the information collected from the study. The correlation of normalized area under the DSC curve with DRC is established and discussed in the following sessions.

5.2: Principle of the method

According to Newton's law of heat flow, the rate of heat flow ($-dQ/dt$) from a body is directly proportional to the difference in temperature (ΔT) the body (T_2) and the surroundings (T_1). The heat flow depends upon the nature of the surface of the body and the area of the exposed surface. The rate of heat flow can be expressed as,

$$\frac{dQ}{dt} = K \Delta T \quad \dots\dots 5.1$$

or

$$\Delta T = K \frac{dQ}{dt} = KC_p\beta \quad \dots\dots 5.2$$

where K is the calorimetric constant, C_p is the specific heat capacity and β is the rate of heating (dT/dt).

In differential scanning calorimetry the final result of a particular experiment is a thermogram showing exothermic or endothermic conventions of heat flux versus temperature or time. The DSC thermogram can be used for calculating the enthalpies of transitions. In an exothermic reaction the energy is released while in an endothermic process energy is absorbed during the reaction.

In a DSC thermogram a negative peak is represented by an exothermic reaction (+ ΔH) and a positive peak represents endothermic (- ΔH) reactions. The enthalpy change of a system can be written as⁵⁴,

$$\Delta H = H_{final} - H_{initial} \quad \dots\dots 5.3$$

or

$$\Delta H = KA \quad \dots\dots 5.4$$

where ΔH is the enthalpy change, H_{final} final is the enthalpy of the system, $H_{initial}$ is the initial enthalpy of the system measured in joules. K is the calorimetric constant and A is the area under curve.

5.3: Experimental procedure

In this work, we have used a Mettler Toledo Model DSC 822^e Differential Scanning Calorimeter to carry out thermal analysis on different sets of latex samples. In DSC 822^e, the multistar FRS5 sensor has a star shaped arrangement of 56 thermocouples providing excellent sensitivity and resolution, and flat baseline. The FRS5 is used as a universal full range DSC sensor. The ceramic sensor plate guarantees robustness and design flexibility. The DSC measurements with 56 (FRS5) or 120 (HSS7) thermocouples guarantee high sensitivity. Further, the DSC instrument is having a digital resolution of 16 million points, excellent baseline stability without data manipulation and broadest dynamic measurement range for investigations. The calibration of the instrument is carried out with the help of 40 ready for use lead or tin pills for temperature and enthalpy calibration.

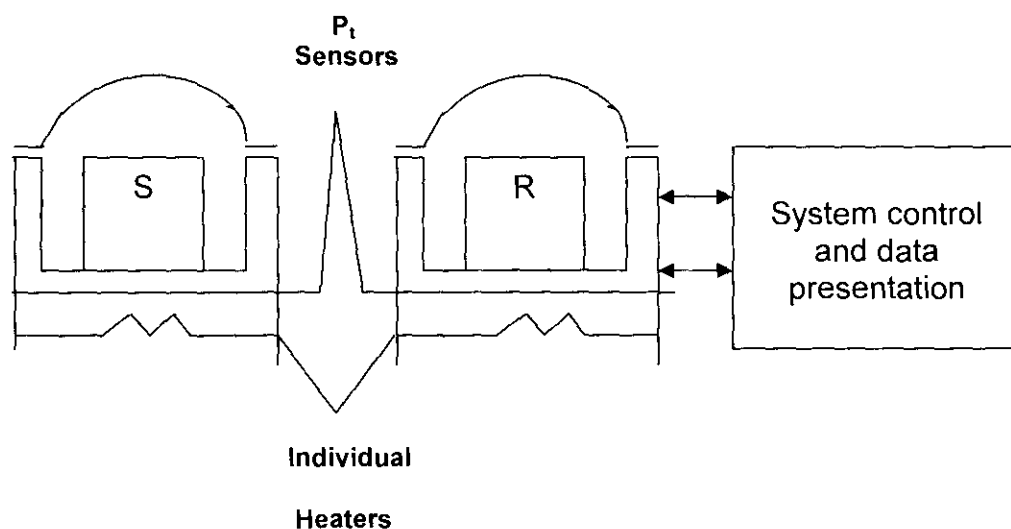

Fig. 5.1 Block diagram of a DSC system

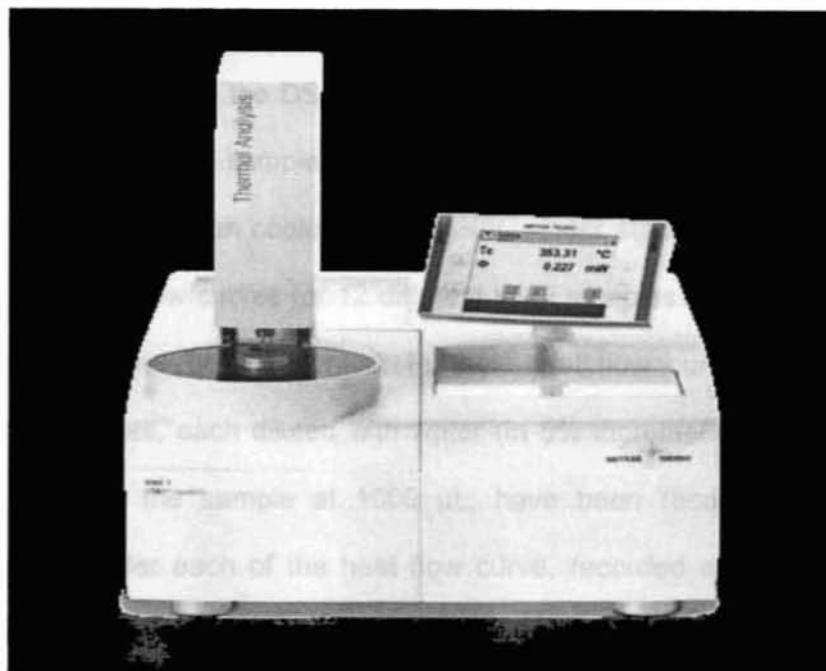

Fig. 5.2: Photograph of a DSC system

The advantages of this DSC instrument are good sensitivity, efficient automation, handling of small and large sample volumes, tailor made solutions for current and future needs. The flexible calibration and adjustment features guarantee accurate and precise measurement results under all conditions. The temperature range of the instrument is from -100°C to 700°C . The ergonomic design of the systems improves intelligence, simplicity and safety to facilitate daily work.

Fresh natural rubber latex samples collected directly from the field are used for the work reported in this thesis. Each latex sample of weight 10-

15 mg, weighed with a Model MX5 Mettler Toledo microbalance, is placed in an aluminum pan after filtration. The sealed aluminum pan containing the sample is then loaded in to the DSC instrument, with an identical empty pan used as the reference. The sample is heated from 30°C to 170°C at a heating rate of 10°C/minute and then cooled back to 30°C under standard laboratory conditions. The heat flow curves for 12 different latex samples collected from 12 different trees have been recorded. Further, heat flow curves for four different latex samples, each diluted with water (in 5% increments), keeping the total volume of the sample at 1000 µL, have been recorded. The normalized area under each of the heat flow curve, recorded as described above, is determined using the system software of the DSC instrument.

The latex samples for all the experiments described in this work have been collected from the experimental field of Rubber Research Institute of India, Kottayam, Kerala, India. Fresh latex samples from different trees (Clone: RR11 105, Year of planting: 1989-93, D3 tapping system) with wide variations in DRC are collected. The latex samples are filtered and 10-15 ml of each sample is collected in separate containers to determine their DRC values following the standard laboratory drying method and another 10-15 mg of each for DSC measurement, as outlined above.

5.4: Results and Discussion

Figure 5.3 shows a typical DSC curve of one latex sample during heating and cooling cycles between 30°C and 170°C. From such DSC

curves for all the samples, the areas of the thermograms between 30°C and 170°C for all the samples have been determined. A few more DSC thermograms are shown in Figures 5.4 (A-D). The calculated mass normalized areas, of the DSC curves along with the corresponding DRC values are tabulated in Table 5.1. It can be noted that sample with higher DRC values have larger areas for their DSC thermograms in the above temperature range. Figure 5.5 shows the variation of the mass normalized area under the DSC thermogram with the corresponding DRC values for the samples determined following the standard laboratory drying method. Figure 5.6 shows the variation of the mass normalized area of the DSC thermograms plotted for one latex sample diluted with water, with the quantity of water added to the sample.

The normalized areas under the DSC thermograms of the samples have good correlation with the DRC values of the samples. The mass normalized area under the DSC curve exhibits a positive correlation coefficient of 0.92 with the corresponding DRC values. Similarly, the mass normalized area of the DSC curve for the sample diluted with water exhibits a positive correlation coefficient of 0.99. We have estimated that a maximum variation of $\pm 5\%$ can occur in the values of normalized area under DSC curve of latex samples. Consequently this can cause an error of $\pm 0.5\%$ in corresponding DRC values. The very purpose of this work is to establish the relation, if any, between changes in enthalpy of the latex sample as water escapes from it with its DRC value and see whether it can be used as a technique to measure

the DRC values of unknown samples. We could establish a good correlation between DRC values and the mass normalized areas, which are a measure of the change in enthalpy of the sample, is established and reported.

Fig. 5.3: A typical DSC Curve of a typical latex sample during heating and cooling cycles.

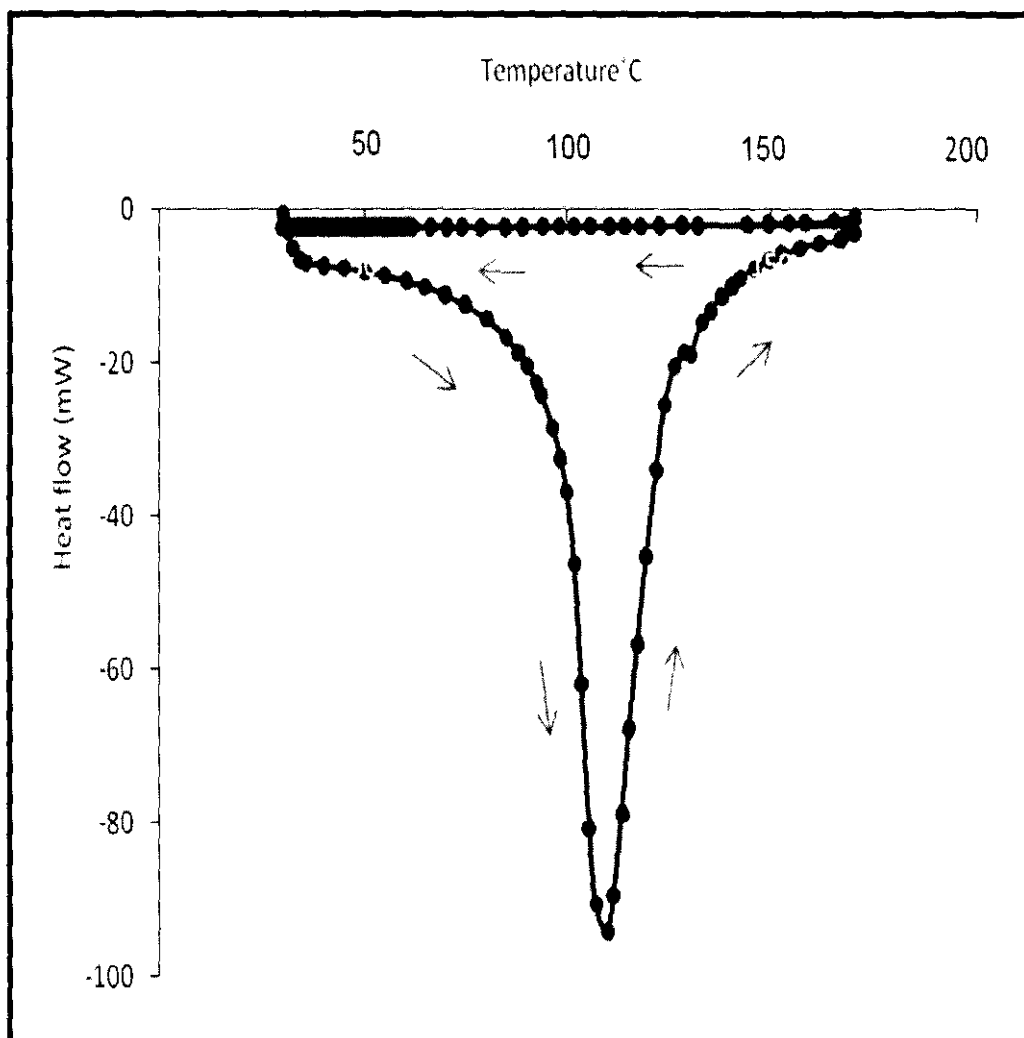

Fig. 5.4 (A to D): DSC curves of different latex sample (DRC values from 25.32 to 50.80 %) in the temperature range 30°C -170°C.

Fig. 5.4 (A)

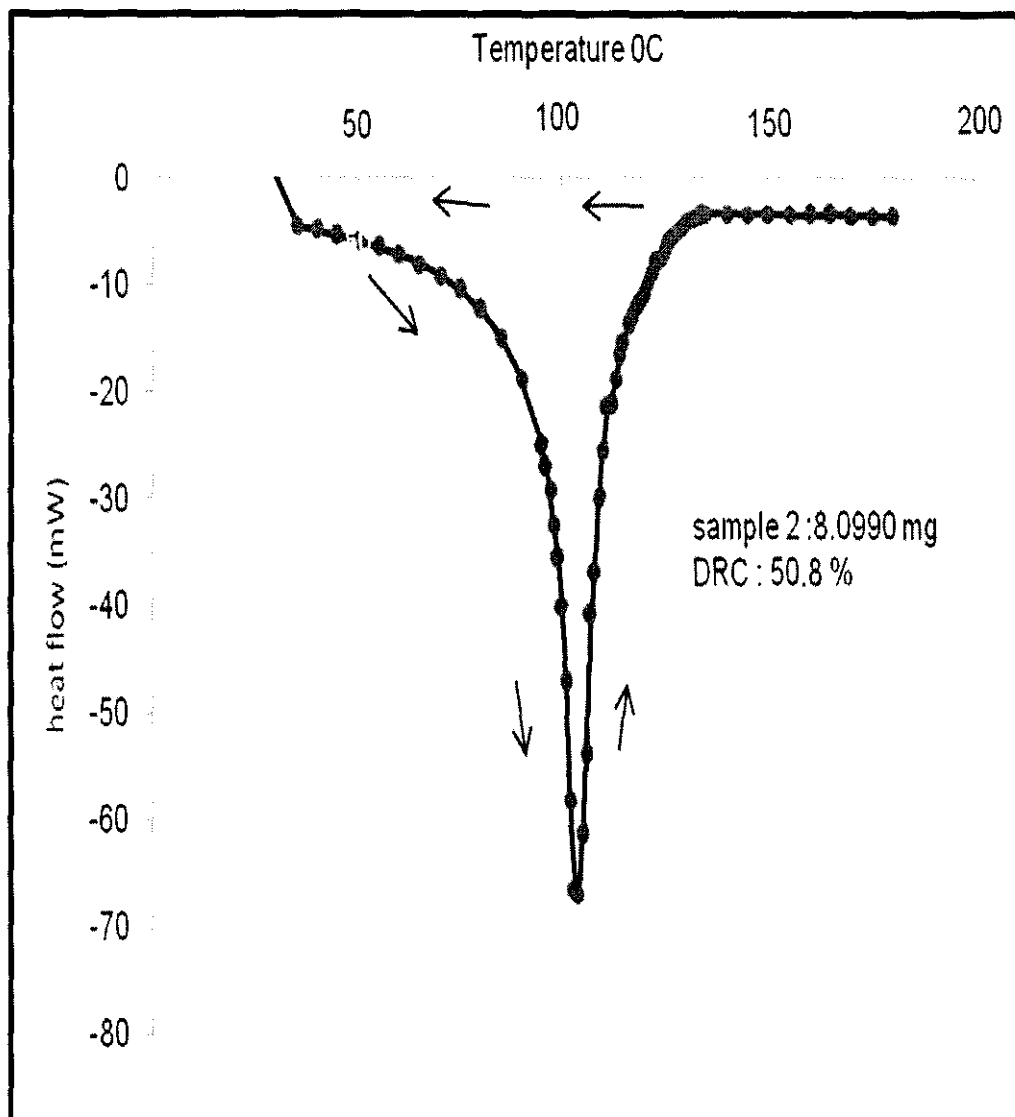

Fig. 5.4 (B)

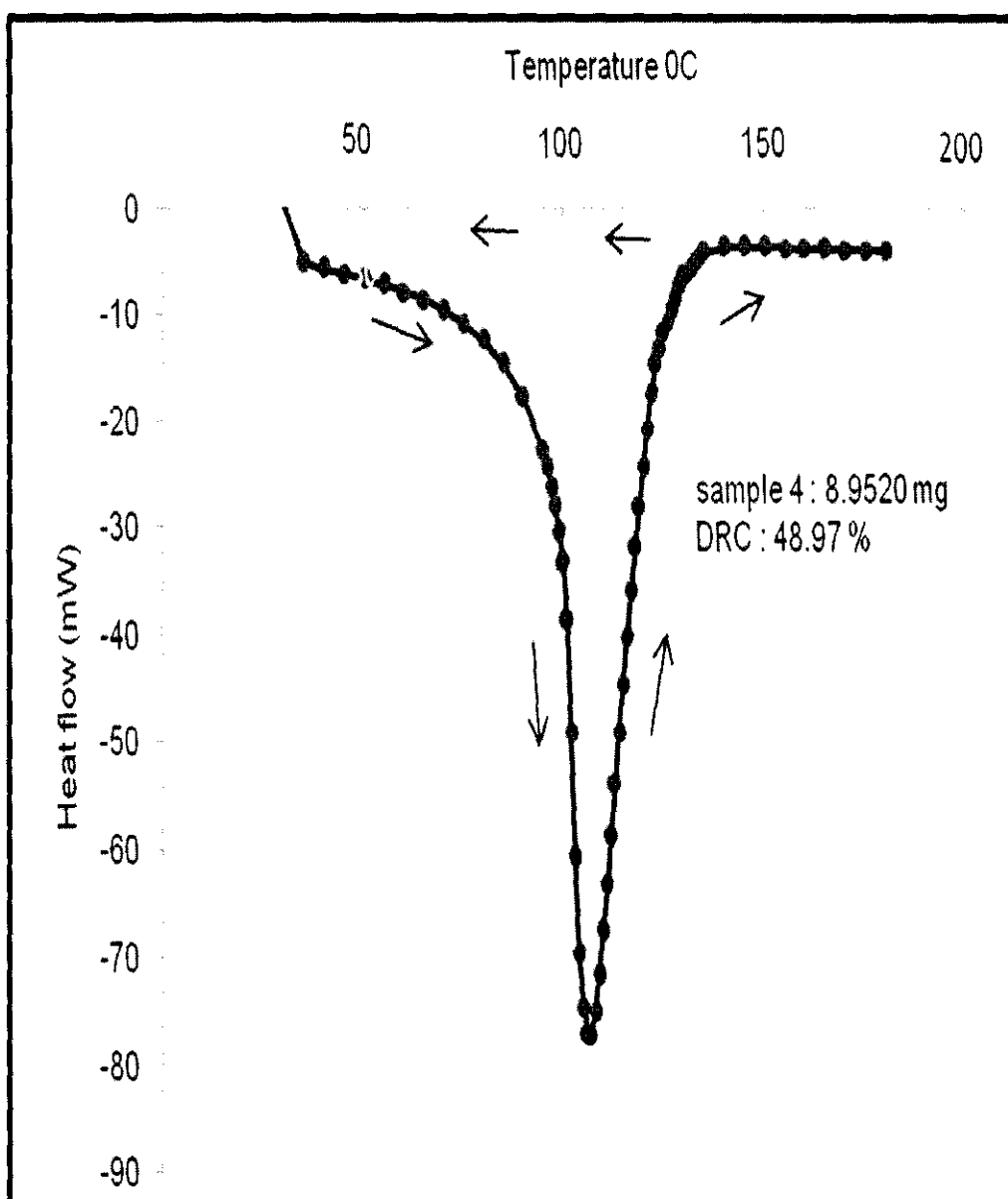

Fig. 5.4 (C)

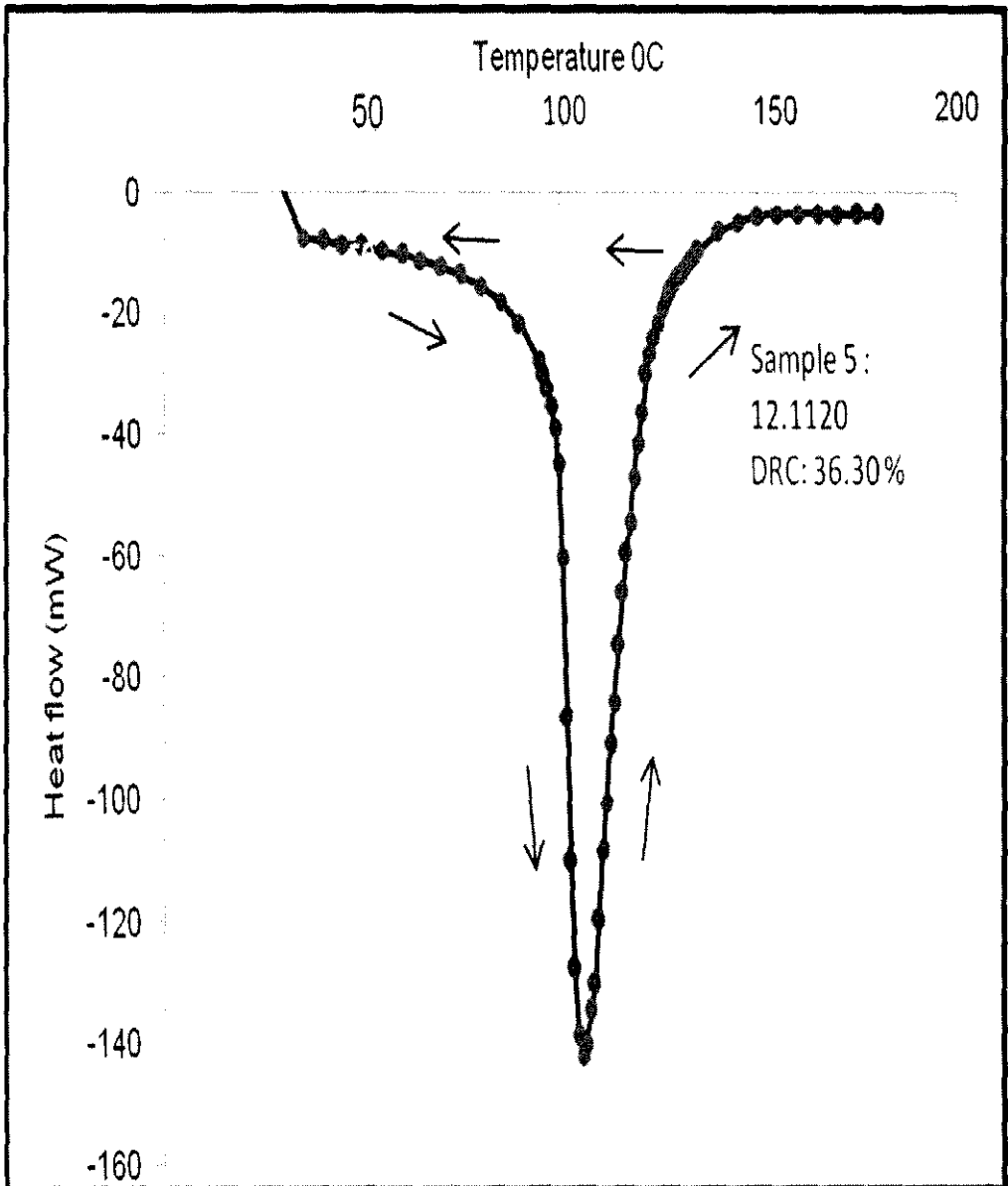

Fig. 5.4 (D)

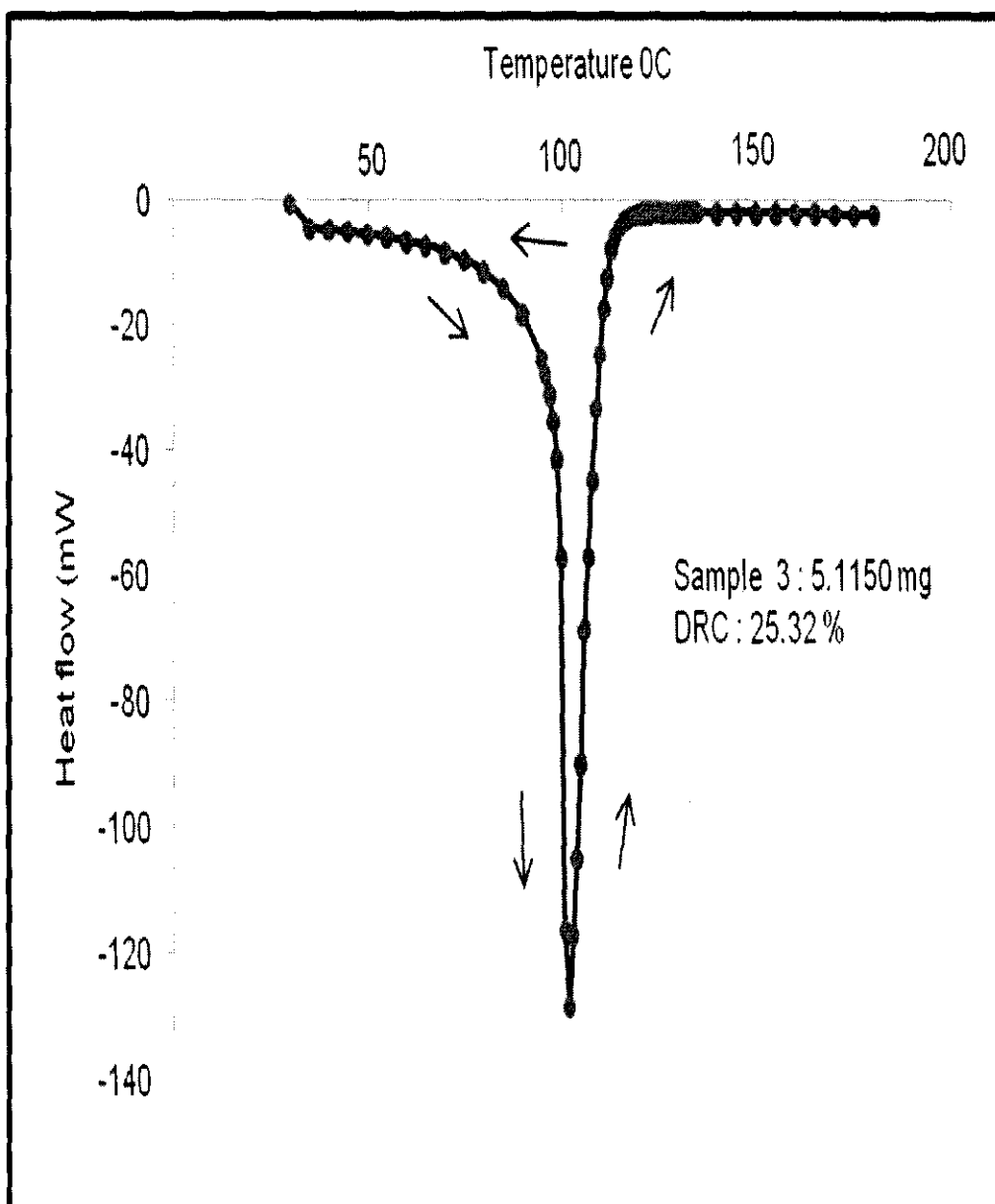

Table 5.1: Variation of Normalized area with Dry Rubber Content for different samples

Sample No.	Weight of the sample (mg) (W)	Total area under DSC curve (mJ) (T)	Normalized area (Jg^{-1}) N = W/T	DRC (%)
1	5.115	-6618	-1294	25.32
2	16.254	-17690	-1089	36.3
3	9.675	-10140	-1048	38.24
4	18.932	-19320	-1021	37.98
5	14.437	-14440	-1003	38.18
6	6.67	-6035	-905	39.88
7	12.753	-11370	-892	40.23
8	9.321	-7583	-867	41.2
9	11.344	-8644	-856	41.95
10	8.952	-6644	-742	48.97
11	12.674	-8318	-656	49.41
12	8.099	-5194	-641	50.8

Fig. 5.5: Variation of normalized area of DSC curves (heat flow) with DRC values measured by laboratory drying method.

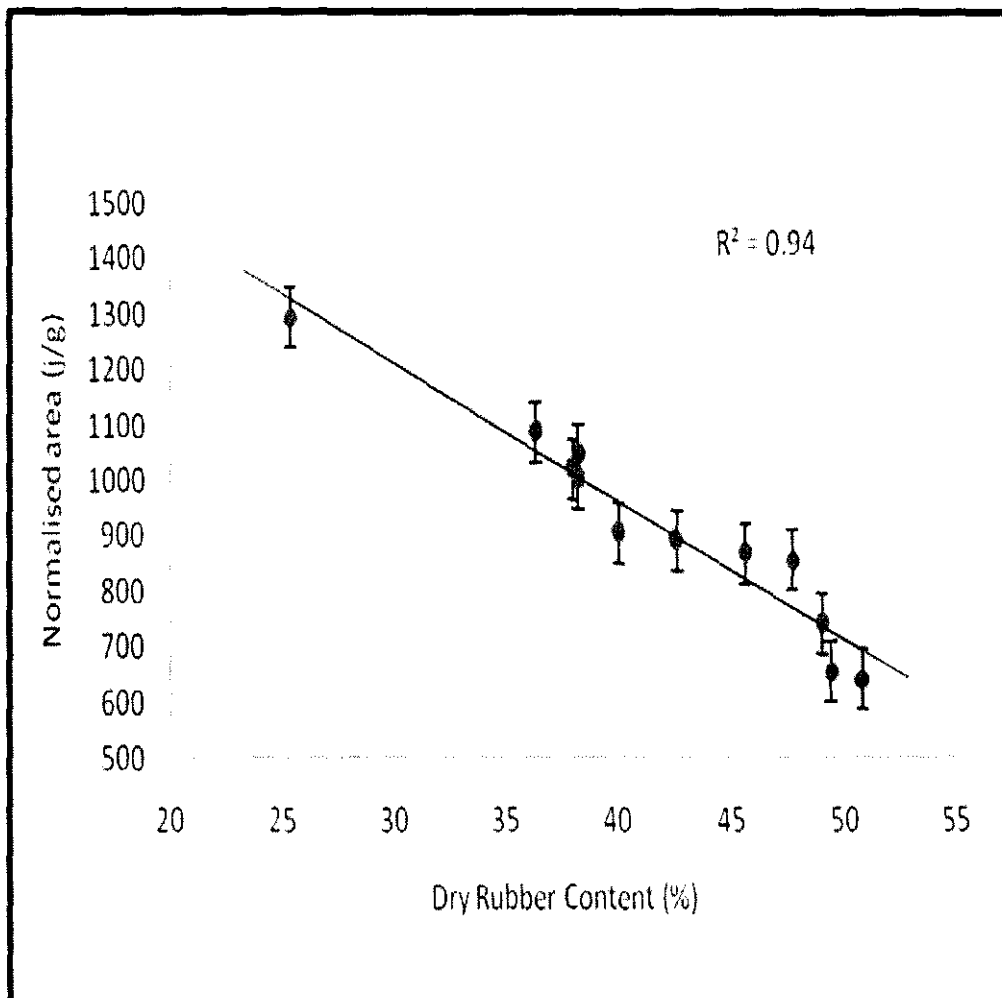
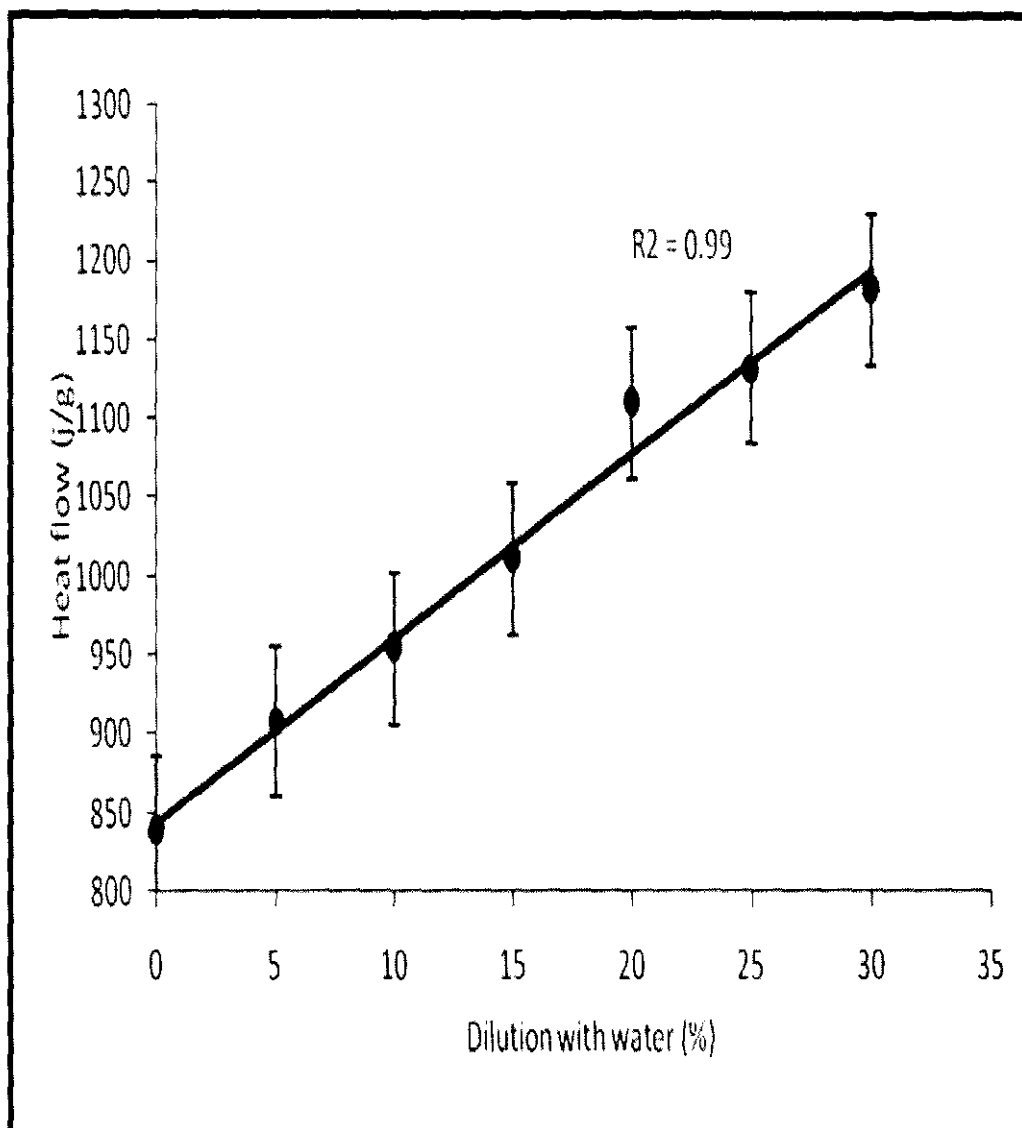

Fig. 5.6: Variation of mass normalized areas of DSC thermogram area (heat flow) with percentage of water added to latex.



5.5: Conclusions

Thermal analysis of natural rubber latex following DSC technique has established a direct proportionality between normalized area of the DSC thermogram or the change in enthalpy of the transition between 30°C and 170°C with the DRC of natural rubber latex. It is found that the above transition is caused by loss of water from the sample, and it is an exothermic process releasing heat from the sample. This result is in tune with the fact that the major constituent of natural rubber latex is water. The DSC technique provides an accurate technique to determine the amount of energy released and relate that directly to the DRC value. Further, the results on the variation of the change in enthalpy of the sample diluted with water (Fig 5.6) strongly support the interpretation of the results on the raw samples with different DRC values (Fig 5.5). Though we could establish a direct relation with total change in enthalpy in the reaction, we have not been able to separate the effects of non rubber constituents such as luteoids, carbohydrates, proteins, lipids and inorganic salts in this reaction. Moreover, it has not been possible to study the effect of anticoagulants and adulterants in latex samples on the DSC thermogram. We think that the information provided by the present investigations would be useful for quick quantification of dry rubber content in natural rubber latex and to design quality standards for the products manufactured using natural rubber latex. In this work we have been able to show that differential scanning calorimetry is an accurate technique for the

estimation of the DRC of rubber latex, though it does not overcome other limitations such as being expensive and requiring skilled personnel for measurement.

References

1. Douglas A. Skoog, James Hollar, F and Timothy A. Nieman, *Principles of Instrumental Analysis*, Harcourt Brace College Publishers, Chicago (1998) 805-806.
2. Khandpur, R.S., *Handbook of analytical instruments*, second edition, Tata McGraw-Hill Professional Electrical Engineering Series, New Delhi (2006) 456-458.
3. Hobart H. Williard, Lynne L. Merrit, Jr., John A. Dean, *Instrumental methods of Analysis*, D. Van Nostrand Company, Inc, New York (1965) 464-465.
4. Strambini, G.B., and E.Gabelheri, *Biophys. J* (1996) **70**: 971 –976.
5. Anderson, W. A., N. D. Hedges, M. V. Jones, and M. B. Cole, *J. Gen. Microbiol* (1991) **137**:1419–1424.
6. Kaletunc, G., *Novel process and control technologies in the food industry*, IOS Press, Amsterdam, The Netherlands (2001) 227-235.
7. Mackey, B. M., C. A. Miles, S. E. Parsons, and D. A. Seymour, *J. Gen. Microbiol* (1991) **137**:2361–2374.
8. Miles, C. A., B. M. Mackey, and S. E. Parsons, *J. Gen. Microbiol* (1986) **132**:939–952.
9. Mohacsi Farkas, C., J. Farkas, L. Meszaros, O. Reichart, and E. Andrassy, *J. Therm. Anal. Calor* (1999) **57**:409–414.

10. Jines, M.J., A.W.Harding, S.D.Brown, and K.M.Thomas, *Carbon* (1995) **33**: 833 – 843.
11. Varley, J.A., C.J.Hindrnarsh, and K.T.Thomas, *Fuel* (1996) 75: 164 – 176.
12. Elisa Lopez – Capel, Saran P. Sohi, John L. Gaunt, and David, A.C. Manning, *Soil Sci. Soc Am. J* (2005) 69: 136 - 140.
13. Grisi, B., C. Grale, P.C. Brookes, A. Benedetti and M.T. Dell' Abate, *Soil. Biol. Biochem* (1998) **30**: 1309 -1315.
14. Dell' Abate, M.T., A. Benedetti, and P.C.Brookes, *J Sep. Sci* (2003) **26**: 433 – 440.
15. Dell Abate, M.T, S. Canali, A. Trinchera, A. Benedetti, and P.Sequi, *J. Thermal. Anal. Calorim* (2000) **61**: 389 - 396.
16. Siewert, C., *Investigation of the thermal and biological stability of soil organic matter*, Shaker Valrlag, Anachen, Germany (2001).
17. Musti J. Swamy, Brigitta Angerstein, and Derek Marsh, *Biophysical Journal* (1994) **66**: 31-39.
18. Shaukat Ali, Sharma Minchey, Andrew Janoff, and Eric Mayhew, *Biophysical Journal* (2000) **78**: 246–256.
19. Sharwan Kakar and Frederick A. Berrelheim, *Investigative Ophthalmology & Visual Science* (1991) **32 (3)**: 562-566.
20. John E. Hale and Friedhelm Schroeder, *Journal of Lipid Research* (1981) 22:38-851.

21. Wilson, P. W., J. W. Arthur, and A. D. J. Haymet, *Biophysical Journal* (1999) **77**: 2850–2855.
22. Jaesung Lee and Go`Nu`I Kaletunc, *Applied and Environmental Microbiology* (2002) **68(11)** : 5379–5386.
23. Javier Cervera, et al, *J. of Biological chemistry* (1993) **268 (17)**: 12504-12511.
24. Giuseppe D'Ascenzo, et al, *Clinical Chemistry* (1978) **24 (1)**: 119 - 121.
25. Bernal, V., and P. Jelen, *J. Dairy Sci.* (1985) **68**:2847.
26. Costas Billiaderis, G., *A review. Food Chem* (1983) **10**:239.
27. Mraw, S.C., *Rev. Sci. Instrum* (1982) **53**:228.
28. Paulsson, M., and P. Dejmek, *J. Dairy Sci* (1990) **73**: 590.
29. Relkin, P., and B. Launay, *Food Hydrocolloids* (1990) **4**:19.
30. Relkin, P., B. Launay, and L. Eynard, *J Dairy Science* (1993) **76**:36-47.
31. Pires, J., M. Brotas De Carvalho, A..P., et al, *Clays and Clay Minerals* (2000) **48(3)**: 385-391.
32. Neuhoff, P. S., and J. Wang, *Clays and Clay Minerals* (2007) **55(3)**: 239-252.
33. Wunderlich, B., and M. Pyda, *Journal of Reinforced Plastics and Composites* (1999) **18(6)** : 487-498.
34. Elbadi M. Yahia and Marisela Rivera Dominguez, *Hort. Science* (1994) **29**: 427-581.

35. Grguric, B. A., R. J. Harrison and A. Putnis, *Mineralogical Magazine* (2000) **64(2)**: 213-231.
36. Catanzano, F., A. Gambuti, G. Graziano and G. Barone, *Biochem* (1997) **121(3)** : 568-577.
37. Govorcin Baisic, E., V. Rek, A. Sendijarevic, V. Sendijaievic, K. C. Frisch, *Journal of Elastomers and Plastics* (2000) **32(2)**: 162-182.
38. Hiroyuki Kaneko, Kaoru Obuchi and Koki Horikoshi, *J. Biochem* (2000) **128(5)**: 727-729.
39. Benjamin, A. Grguric, and Andrew Putnis, *The Canadian Mineralogist* (1998) **36(1)**: 215-227.
40. Akiyoshi Tanaka, *J. Biochem* (1998) **123 (2)**: 289-293.
41. Philips, D.G., *Textile Research Journal* (1985) **55 (3)**: 171-174.
42. Toshihiko Sugiura, Mitsura Yoshida, Jun Magoshi, Sukeyyuki, *Journal of Reinforced Plastics and Composites* (1999) **18(6)**: 476-486.
43. Kunio Nakamura, Tatsuko Hatakeyama, Hyoe Hatakeyama, *Textile Research Journal* (1981), **51(9)**: 607-613.
44. Lopez, C., P. Lesieur, C. Bourgaux and M. Ollivon, *J. Dairy Sci.* (2005) **88**: 511–526.
45. Keller, G., et al, *J. Thermal Anal.* (1998) **51**:783–791.
46. Keller, G., F. Lavigne, C. Loisel, M. Ollivon, and C. Bourgaux, *J. Thermal Anal* (1996) **47**:1545–1565.
47. Marie Paulsson and Petr Dejmek, *J Dairy Sci.* (1990) **73**:590-600.
48. Sturtevant, J. M., *Ann. Rev. Biophys. Bio.Engg* (1974) 3:35.

49. Ursula Reh, Gunda Kraepelin, and Ingolf Lamprecht, *Applied and Environmental Microbiology* (1986) 1101-1106.
50. Michael H. Tunick, et al, *J Dairy Sci* (1989) **72**:1976-1980.
51. Nichola C. Garbett et al, *Clinical Chemistry* (2007) **53** (11): 2012 – 2014.
52. Lopez, C., V. Briard-Bion, B. Camier, and J. Y. Gassi, *J. Dairy Sci* (2006) **89**:2894–2910.
53. Miriam Almagor and R. David Cole, *Cancer Research* (1989) **49**: 5561-5566.
54. Olaf Runquist, Clifford J Creswell, J. Thomas Head, *Thermodynamics and kinetics: in Chemical principles*, Burgas Publishing Company, Vakils, Feffer and Simons Private Limited, Mumbai (1979) 266-272.

CHAPTER SIX

Summary and Conclusions

7.1: Summary of the work done

Though the dry rubber content is an important parameter for the natural rubber latex industry for various decision making purposes, an accurate and rapid method to measure this is yet to be developed. Substantial work has been done to develop a rapid, economical and accurate system. The most accurate method to determine the DRC is the standard laboratory drying procedure. The main disadvantages of this method are the requirement of high capital investment, demand of labour and nonadaptability for use in the field. The most rapid method to determine DRC is by using hydrometer. However, unbiased and accurate measurements cannot be made with a hydrometer due to various factors. Several methods, such as, microwave techniques, low resolution NMR technique and titration method are also reported for the rapid measurement of DRC. These methods suffer from several drawbacks such as being expensive, inaccurate, not environment friendly, difficult to use and unable to adapt to the field. The investigations presented in the thesis are carried out to gather useful information for the design and develop of a rapid instrumentation system to measure the DRC of natural rubber latex with sufficient accuracy.

At first, we have carried out, Mid IR absorption studies on latex samples in the spectral range 500 cm^{-1} to 4000 cm^{-1} and we could establish a relation between normalized differential transmittance around a specific wave number with DRC values of latex samples determined under standard laboratory drying method. A systematic study of latex samples employing TGA techniques was carried out. The results show that the percentage weight loss in a specific temperature range shows a high positive correlation with DRC values estimated by laboratory drying method. A capacitive transducer has been designed and fabricated for measuring the dielectric properties of latex. The capacitances of several latex samples are measured using the capacitive transducer and a standard LCR meter. A good correlation has been obtained between dielectric properties and the corresponding DRC values.

We have also carried out NIR absorption measurements on several latex samples. We could not find any notable change in NIR absorption with corresponding DRC value in the transmittance mode. The experiments have been performed with a Diffused Reflectance Assay in the spectral range of 500 nm to 2000 nm. The spectral responses of a number of latex samples have been analyzed and we could establish a proportionality relation between the reflectance values at 1460 nm and with the corresponding DRC values. The major constituent of latex is water. The variations in the intensity of IR radiation in this wavelength range are interpreted as due to the molecular vibrations of water molecules.

The Differential Scanning Calorimetry has been employed to study changes in enthalpy of latex sample when subjected to a controlled temperature program. We could see that the normalized areas under DSC curves for different latex samples exhibit a direct proportionality relation with DRC values of latex samples. We could establish a high correlation between mass normalized enthalpy changes in a defined temperature range with the corresponding DRC values.

7.2: Conclusions

During the course of this research work, we have developed several techniques to estimate the DRC of natural rubber latex using various instrumentation techniques. The major drawback of the capacitance method is that it lacks reproducibility of results due to the ionic activity in the latex medium. Measurement of various parameters using the techniques such as TGA, DSC and NIR have established direct relation with DRC of latex estimated using laboratory drying method. However these techniques suffer from limitations such as being expensive, difficulties for use in the field and requirement of skilled man power for handling the instrumentation systems. In the FTIR studies we have seen that at 835 cm^{-1} , the normalized differential transmittance exhibit a good correlation with DRC. The change in intensity is in this region is due to the molecular vibration of isoprene polymer (rubber). By measuring the transmittance at that particular wave number, we are

actually quantifying the rubber present in the latex. Information collected from these FTIR studies might turn out to be useful in designing a viable DRC measurement system by incorporating suitable sources and detection systems.

7.3: Future scope for work

We have developed different methods, including a direct measurement method employing the Fourier Transform Infra Red Spectroscopy in the MIR range around 835 cm^{-1} for estimating the DRC of latex. We have not studied the effect of adulterants and anticoagulants in this measurement. A systemic measurement of latex samples after adding anticoagulants and adulterants in different concentrations are desirable to understand the effect of these on the transmittance at 835 cm^{-1} . The information collected from the FTIR study is useful in designing a practical DRC measurement system. We are investigating the possibilities of designing a practical field usable and economical instrument based on this technique.

Even after decades of development work we still do not have an instrument to measure DRC of latex, which is economical, quick, field usable and requiring no skilled man power. We are still working on it. We hope the results presented in this thesis will help to develop such an instrument in the near future.

