

# **A STUDY ON THE WATER RETENTION CHARACTERISTICS OF SOILS AND THEIR IMPROVEMENTS**

*A Thesis*

*Submitted by*

**MARIAMMA JOSEPH**

*for the award of the degree  
of*

**DOCTOR OF PHILOSOPHY  
(Faculty of Engineering)**



**DIVISION OF CIVIL ENGINEERING  
SCHOOL OF ENGINEERING  
COCHIN UNIVERSITY OF SCIENCE AND TECHNOLOGY  
Kochi – 682 002  
November 2010**

## *Certificate*

Certified that this thesis entitled “**A Study on the Water Retention Characteristics of Soils and their Improvements**”, submitted to Cochin University of Science and Technology, Kochi for the award of Ph.D. Degree is the record of bonafide research carried out by Smt. Mariamma Joseph under my supervision and guidance at School of Engineering, Cochin University of Science and Technology,. This work did not form part of any dissertation submitted for the award of any degree, diploma, associate ship or other similar title or recognition from this or any other institution

**Dr.Babu T.Jose**

(Supervising Guide)

Emeritus Professor

School of Engineering

Cochin University of Science & Technology

Kochi-22

23/11/2010

## *Declaration*

I, Mariamma Joseph hereby declare that the work presented in the thesis entitled **“A Study on the Water Retention Characteristics of Soils and their Improvements”**, being submitted to Cochin University of Science and Technology for the award of Doctor of Philosophy under the Faculty of Engineering, is the outcome of original work done by me under the supervision of Dr.Babu T. Jose, Emeritus Professor, School of Engineering, Cochin University of Science and Technology,Kochi-22.This work did not form part of any dissertation submitted for the award of any degree, diploma, associate ship or other similar title or recognition from this or any other institution

Kochi-22

23/11/2010

Mariamma Joseph

Reg. No. 2679

---

## *Acknowledgement*

---

*I thank the Almighty who has gracefully overseen all my humble efforts in fulfilling this piece of work which would be a land mark prelude into achieving a glorious goal.*

*I have great pleasure in placing on record my deep sence of indebtedness and gratitude to my guide Prof (Dr.) Babu. T. Jose, Emeritus Professor, School of Engg, Cochin University of Science and Technology for his timely advice, whole hearted guidance, valuable suggestions, continued assistance and pains taken by him for the successful completion of this work.*

*I express my deep sincere gratitude to Dr.Benny Mathews Abrahm Head of Civil Division , School of Engineering, Cochin University of Science and Technology for his help, constructive comments and discussions during the various phases of the work.*

*I am deeply indebted to Dr. T.S Ramanatha Iyer former Director of Technical Education Kerala for his valuable advice and suggestions throughout the course of work.*

*I am grateful to Dr.Sobha Cyrus, Reader in Civil Engineering, School of Engineering, Cochin University of Science and Technology for all sort of academic & other helps rendered to me throughout this venture.*

*I wish to thank Dr. Pushkala.S former Professor in Soil Physics, Agricultural College, Vellayini, Trivandrum for the suggestions and helps rendered to me at very initial stage of this work. I express my sincere thanks to Dr.Xaviar Jacob, Head of Agricultural Engineering and Dr.P.B Usha, Professor in Soil Science and applied Chemistry, Agricultural College, Vellayni, Trivandrum for their help and suggestion during the course of work.*

*I wish to express my gratitude to Dr. Byju.G, Senior Scientist and Laboratory staff of Central Tuber Crops Research Institute, Trivandrum and the Chemist & Staff of Government Analysts Laboratory, Trivandrum for their help and support for the timely completion of this work.*

*I would like to place on record my sincere thanks to the Principal, College of Engineering, Trivandrum for granting permission to carry out my research work.*

*I wish to express my sincere and heartfull thanks to all the faculty members, laboratory staff and research students of college of engineering for their help rendered during the course of work.*

*I wish to thank the laboratory staffs Smt.Saramma E.J, Shri. P.A Aboobakker and others for their help and co-operation during the course of work.*

*I express my heartfelt thanks to my husband Tomy and children Shilpa and Shikha for their forbearance, co-operations and cheerful dispositions which were vital for sustaining the effort required for computing the doctoral pogramme. I also express my gratitude to my parents and family members for love and affection bestowed on me over the period of work.*

***Mariamamma Joseph***

## ABSTRACT

Soil moisture plays a cardinal role in sustaining ecological balance and agricultural development – virtually the very existence of life on earth. Because of the growing shortage of water resources, we have to use the available water most efficiently by proper management. Better utilization of rainfall or irrigation management depends largely on the water retention characteristics of the soil.

Soil water retention is essential to life and it provides an ongoing supply of water to plants between periods of irrigation so as to allow their continued growth and survival.

It is essential to maintain readily available water in the soil if crops are to sustain satisfactory growth. The plant growth may be retarded if the soil moisture is either deficient or excessive. The optimum moisture content is that moisture which leads to optimum growth of plant. When watering is done, the amount of water supplied should be such that the water content is equal to the field capacity that is the water remained in the saturated soil after gravitational drainage. Water will gradually be utilized consumptively by plants after the water application, and the soil moisture will start falling. When the water content in the soil reaches the value known as permanent wilting point (when the plant starts wilting) fresh dose of irrigation may be done so that water content is again raised to the field capacity of soil.

Soils differ themselves in some or all the properties depending on the difference in the geotechnical and environmental factors. Soils serve as a reservoir of the nutrients and water required for crops.

Study of soil and its water holding capacity is essential for the efficient utilization of irrigation water. Hence the identification of the geotechnical parameters which influence the water retention capacity, chemical properties which influence the nutrients and the method to improve these properties have vital importance in irrigation / agricultural engineering. An attempt in this direction has been made in this study by conducting the required tests on different types of soil samples collected from various locations in Trivandrum district Kerala, with and without admixtures like coir pith, coir pith compost and vermi compost. Evaluation of the results are presented and a design procedure has been proposed for a better irrigation scheduling and management.

## CONTENTS

<i>Acknowledgement</i>	<i>i</i>
<i>Abstract</i>	<i>iii</i>
<i>Table of contents</i>	<i>iv</i>
<i>List of tables</i>	<i>viii</i>
<i>List of figures</i>	<i>x</i>
<b>CHAPTER -1 INTRODUCTION</b>	<b>1</b>
1.1 General	1
<b>CHAPTER -2 LITERATURE REVIEW</b>	<b>6</b>
2.1 Introduction	6
2.2 Irrigation Methods	6
2.3 Precision Farming & Fertigation	7
2.4 Classification of Soil	8
2.4.1 Particle size Classification	8
2.4.2 Textural Classification	10
2.5 Soil, Water and Plant Relationships	12
2.6 Soil Physical Properties	12
2.6.1 Soil Composition	12
2.6.2 Soil Texture	13
2.6.3 Soil Structure	14
2.6.4 Bulk Density and Porosity of Soil	14
2.7. Soil Moisture Properties	15
2.7.1 Evaporation	15
2.7.2 Water Retention Capacity of Soil	16
2.7.3 Field Capacity	18
2.7.4 Permanent Wilting Percentage or Wilting Coefficient	19
2.7.5 Available water	19
2.7.6 Hygroscopic Coefficient	20
2.7.7 Hydraulic Conductivity	20
2.8 Soil Chemical Properties	20
2.8.1 Exchange Capacity	20
2.8.2 Soil pH	21
2.9 Soil Biological Properties	21
2.10 Relation between Plant and Water	21

2.10.1 Water Quality	23
2.10.1.1 <i>Physico-Chemical Qualities</i>	24
2.10.1.2 <i>Bacteriological Contamination</i>	25
2.10.1.3 <i>Irrigation Water Quality</i>	27
2.11 Admixtures for Better Water Retention	28
2.11.1 Coir Pith	28
2.11.2 Coir pith Compost	29
2.11.3 Vermi Compost	30
2.12 pH of Soil	30
2.13 Cation Exchange Capacity	31
2.14 Nutrients of Soil	31
2.14.1 Essential Nutrients	32
2.14.1.1 <i>Macro Nutrients</i>	32
2.14.1.2 <i>Micro Nutrients</i>	34
2.15 Previous Studies	35
2.17 Objectives	40
2.16 need for the study	40
<b>CHAPTER – 3 MATERIALS AND METHODS</b>	<b>41</b>
3.1. Introduction	41
3.2 Materials Used	41
3.2.1 Soils	42
3.2.2 Water	47
3.2.3 Admixtures	48
3.2.3.1 <i>Coir Pith</i>	49
3.2.3.2 <i>Coir Pith Compost</i>	49
3.2.3.3 <i>Vermi Compost</i>	50
3.3 Methods for Determination of Moisture and Material Characteristics	52
3.3.1 Evaporation Loss and Field Capacity	52
3.3.2. Field Capacity by Pressure Plate Apparatus	55
3.3.3 Hydraulic Conductivity	61
3.3.4. pH, Nutrients and Cation Exchange Capacity of various soils	64
3.3.5 Quality of Water	69



**CHAPTER – 4 STUDIES ON RETENTION CAPABILITY OF UNTREATED SOILS 72**

4.1 Introduction	72
4.1.1 Soil Texture and Porosity	72
4.1.2. Field Capacity and Permanent Wilting Point	73
4.1.3 Factors Affecting water Holding Capacity of Soils	74
4.2 Textural Classification of Soils	74
4.3. Evaporation Losses and Water Holding Capacity	79
4.3.1 Factors affecting evaporation losses	79
4.3.2 Investigations on Evaporation Losses	80
4.3.3 Control of Evaporation losses	82
4.3.4 Studies on Water Holding Capacity	86
4.3.5 Water Use Efficiency and Irrigation Interval	92
4.4 Soil Moisture Tension	95
4.5. Study on Hydraulic Conductivity of Various Soils	98
4.6. Study on PH and Nutrients of Various Soils	99
4.7. Quality of Water	102

**CHAPTER -5 STUDIES ON WATER RETENTION CAPABILITY OF TREATED SOILS 105**

5.1. Introduction	105
5.1.1 Parameters for Selection of Admixtures	105
5.1.2 Coir Based Admixtures	106
5.2. Studies on Admixtures	107
5.3. Studies on Soils Treated With Admixtures	108
5.3.1. Studies on Soils Treated with Coir Pith	110
5.3.2. Improvement in Irrigation Interval with Admixtures	113
5.3.3. Studies on Soils Treated With Coir Pith Compost	118
5.3.4. Effect of Coir pith Compost on Irrigation Intervals	124
5.3.5. Studies on Soil Treated Vermi Compost	126
5.3.6. Comparative Study of the Soils when Treated with Different Admixtures	127
5.4. Effects of Admixture on Soil Moisture Tension	136
5.4.1 Effect of Coir Pith on Soil Moisture Tension	136
5.4.2 Effect of Coir pith Compost on Soil Moisture Tension	141
5.4.3 Effect of Vermi Compost on Soil Moisture Tension	144

5.5. Elements Required in Plant Nutrition	145
5.5.1 Effect of Varying Percentage of Admixtures on pH Value, Nutrients and Cation Exchange Capacity of Soils	146
5.5.2. Effect of Addition of Coir Pith on Essential Elements	147
5.5.3. Effect of Addition of Coir Pith Compost on Essential Elements	152
5.5.4 Effect of Addition of Vermi Compost on Essential Elements	157
5.6. Study on Hydraulic Conductivity of Soil	163
5.6.1 Variation of Water Content with Fineness of Soil	164
5.6.2 Effect of Admixtures on Hydraulic Conductivity	164
5.7 Effect of planting on treated soils	168
5.7.1 Chemical Analysis of Treated Soils after Planting	169
5.7.2 Chemical analysis of the effluent water	177
<b>CHAPTER -6 CONCLUSIONS</b>	<b>183</b>
6.1 Introduction	183
6.2 Water Holding Capacity and Relative Density of Soil	183
6.3 Evaporation Losses from Soil	184
6.4 Field Capacity and Permanent Wilting Point	184
6.5 Water Use Efficiency and Irrigation Interval	185
6.6 Hydraulic Conductivity	186
6.7 Nutrient Values of Soils and Quality of Water	186
6.8 Studies on Soils Treated With Admixture	187
6.8.1 Soil Treated with Coir Pith	187
6.8.2 Soil Treated with Coir Pith Compost	188
6.8.3 Soil Treated with Vermi Compost	189
6.9 Essential Elements in Plant Nutrition	189
6.10 Effect of Admixtures on Hydraulic Conductivity	190
6.11 Effect of Admixtures on Plant Growth	190
<b>REFERENCES</b>	<b>192</b>
<b>LIST OF PUBLICATIONS</b>	<b>200</b>

## LIST OF TABLES

Table.2.1.	Diameter and appropriate size of four types of soil particles .....	11
Table 2.2	Water Quality Standards as approved by Bureau of Indian Standards.....	26
Table 2.3	Standards for Irrigation waters .....	27
Table 2.4	Soil pH and Interpretation.....	30
Table 2.5	Limits for different nutrient parameters of soil .....	32
Table 3.1	Particle Size Distribution of Soils as per IS Classification .....	35
Table 3.2	Particle Size Distribution of Soils as per Textural Classification / Modified Textural Classifications .....	46
Table 3.3	Physical Properties of Soil.....	46
Table 3.4	pH Value and Nutrients of Soil Samples.....	47
Table 3.5	Quality of Water Used .....	48
Table 3.6	Chemical Composition of CP, CC and VC .....	51
Table 4.1	Textural Classification of Soils .....	75
Table 4.2	Relation between Relative Density, Porosity and Field capacity .....	77
Table 4.3	Dry Densities and Field Densities of Different Soils .....	78
Table 4.4	Results of Available Water .....	88
Table 4.5	Saturated Water Content and Field Capacity.....	97
Table 4.6	Hydraulic Conductivity of Various Soils .....	98
Table 4.7	OC, pH, NPK, CA and C EC Values of Soils on and after Three Months of Watering .....	101
Table 4.8	Comparison between Water Used and Effluent Water .....	103
Table 5.1	Water Retention Characteristics of Admixtures and Soils .....	107
Table 5.2	Improvement of Plant Available Water with admixtures .....	109
Table 5.3	Increase in FC, PWP, PAW for addition of 10% coir pith.....	139
Table 5.4	Increase in FC, PWP, PAW for addition of 10% coir pith compost .....	142
Table 5.5	Increase in FC, PWP, PAW for addition of 10% vermi compost.....	144
Table 5.6	Increase in PAW for the three admixtures .....	145
Table 5.7	Effect of CP on pH value, Nutrients and Cation Exchange Capacity of Soils.....	148
Table 5.8	Effect of Coir pith Compost on pH value, Nutrients and Cation Exchange Capacity of Soils .....	153
Table 5.9	Effect of Vermi Compost on pH value, Nutrients and Cation Exchange Capacity of Soils.....	158
Table 5.10	Effects of pH value and Nutrients on Soil With 10% Coir Pith .....	162
Table 5.11	Effect of pH value and Nutrients on Soil With 10% Coir Pith Compost .....	163

Table 5.12	Effect of pH value and Nutrients on Soil With 10% Vermi Compost.....	163
Table 5.13	Effect of Admixtures on the Hydraulic Conductivity of Different Soils.....	168
Table 5.14	Effect of CP on pH, OC, and CEC before and after Planting.....	170
Table 5.15	Effect of CP on N, P, K, Ca before and after Planting.....	171
Table 5.16	Effect of CC on pH, OC, and CEC before and after Planting.....	173
Table 5.17	Effect of CC on N,P,K and Ca before and after Planting.....	174
Table 5.18	Effect of VC on pH, OC, and CEC before and after Planting.....	175
Table 5.19	Effect of VC on N,P,K and Ca before and after Planting.....	176
Table 5.20	Effect of CP on Effluent Water for S1 after Planting.....	179
Table 5.21	Effect of CP on Effluent Water for S2 after Planting.....	180
Table 5.22	Effect of CP on Effluent Water for S3 after Planting.....	181
Table 5.23	Effect of CP on Effluent Water for S4 after Planting.....	181

## LIST OF FIGURES

Fig. 2.1	Grain Size Classification Scale .....	9
Fig 2.2	Textural Classification Chart .....	10
Fig 2.3	Modified Triangular Chart.....	11
Fig 2.4	The four components of soil Minerals and SOM.....	13
Fig 2.5	Simplified Comparison of the Water Holding Characteristics of different Textured Soils .....	13
Fig 2.6	Soil Structure.....	14
Fig 2.7	Generalized porosity in sandy and clayey soil .....	15
Fig. 2.8	Schematic Course of Evaporation from an Initially Wet Soil under Different Conditions.....	16
Fig. 2.9	Soil-Water Retention Curves for Four different Soil Types and their Ranges of Plant Available water. ....	18
Fig. 2.10	A soil at saturation, FC and PWP. Pictorial representation .....	22
Fig. 2.11	Relationship of soil texture with soil water content.....	23
Fig. 3.1	Particle Size Distribution curve for Soils S1, S2, S3 and S4 under Study .....	43
Fig. 3.2	Particle Size Distribution curve for Soils S5, S6 and S7 under Study.....	44
Fig. 3.3	a. Coir Pith .....	50
Fig. 3.3	b. Coir pith Compost.....	50
Fig. 3.3	c. Vermi Compost .....	50
Fig. 3.4	Particle Size Distribution Curve for Admixtures .....	51
Fig. 3.5	Test Specimens.....	54
Fig.3.6a.	5 Bar Pressure Plate Extractor .....	57
Fig.3.6b.	15 Bar Ceramic Plate Extractor.....	57
Fig. 3.7	Schematic View of Pressure Plate Test Setup.....	58
Fig. 3.8	Cross-section view of ceramic pressure plate cell and soil sample, in Extractor.....	59
Fig. 3.9	Soil samples kept for saturation.....	59
Fig 3.10	Experimental setup for Permeability Measurement .....	62
Fig. 3.11.	Vertical Permeability using Rowe Consolidometer. ....	63
Fig 3.12	Experimental setup for Permeability Measurement using Rawe cell apparatus .....	63
Fig 3.13	Experimental setup.....	65

Fig 3.14	Experimental setup.....	66
Fig. 3.15	Schematic Diagram .....	66
Fig. 4.1	Variation of Field Capacity with Relative Density .....	76
Fig. 4.2	Relation between in situ porosity and percentage of fines.....	79
Fig 4.3	Variation of Evaporation Loss with Time for S2 and S3 Kept at Sun Light and Room Temperature.....	81
Fig 4.4	Variation of Evaporation Loss with Time for Soils Exposed to Direct Sunlight and Kept at Room Temperature .....	84
Fig 4.5	Relation between the Time for Evaporation and Percentage Fines.....	85
Fig 4.6	Effect of Mulching with Percentage Fines .....	86
Fig. 4.7	Variation of Water Content of Soils with Time kept at Room Temperature.....	87
Fig.4.8.	Variation of Water Content with Fineness of Soil .....	88
Fig. 4.9	Relation between Field Capacity with Percentage of Fines.....	89
Fig. 4.10	Relation between Permanent Wilting Point and Percentage Fines.....	90
Fig. 4.11	Relation between Percentage of Soil Fines and Water Content.....	91
Fig. 4.12	Relation between Plant Available Water and Percentage Fines.....	91
Fig: 4.13	Variation of Water Content with Time for S2 and S3 at Room Temperature .....	93
Fig 4.14	Variation of Water Content with Time for S2 and S3 Kept at Sun Light.....	94
Fig. 4.15	Variation of Water Content of Soils with Water Potential.....	96
Fig. 4.16	Relationship between pF (Logarithm of pressure head in cm) value and Moisture Content of Soils .....	97
Fig. 4.17	Relationship between Hydraulic Conductivity and Percentage Fines.....	99
Fig. 5.1	Field Capacities of Different Admixtures and Soils .....	108
Fig. 5.2	Variation of Water Content with Time for S1 Mixed with CP .....	111
Fig. 5.3	Variation of Water Content with Time for S2 Mixed with CP .....	112
Fig. 5.4	Variation of Water Content with Time for S3 Mixed with CP .....	114
Fig. 5.5	Variation of Water Content with Time for S4 Mixed with CP .....	115
Fig 5.6	Percentage of Coir Pith Vs Water Content for S1 after 10, 20 and 30 Days .....	117
Fig 5.7	Percentage of Coir Pith Vs Water Content for S2 after 10, 20 and 30 Days. ....	117
Fig. 5.8	Percentage of Coir Pith Vs Water Content for S3 after 10, 20 and 30 days.....	119
Fig. 5.9	Percentage of Coir Pith Vs Water Content for S4 after 10, 20 and 30 days.....	119
Fig. 5.10	Variation of Water Content with Time for S1 Mixed with CC .....	120

Fig. 5.11	Variation of Water Content with Time for S2 Mixed with CC .....	121
Fig. 5.12	Variation of Water Content with Time for S3 Mixed with CC .....	122
Fig. 5.13	Variation of Water Content with Time for S4 Mixed with CC .....	123
Fig. 5.14	Percentage of Coir pith Compost Vs Water Content for S1 after 10, 20 and 30 days. ...	124
Fig. 5.15	Percentage of Coir pith Compost Vs Water Content for S2 after 10, 20 and 30 days. ...	124
Fig 5.16	Percentage of Coir pith Compost Vs Water Content for S3 after 10, 20 and 30 days. ...	126
Fig. 5.17	Percentage of Coir pith Compost vs Water Content for S4 after 10, 20 and 30 days.....	126
Fig. 5.18	Variation of Water Content with Time for S1 Mixed with VC .....	128
Fig. 5.19	Variation of Water Content with Time for S2 Mixed with VC .....	129
Fig. 5.20	Variation of Water Content with Time for S3 Mixed with VC .....	130
Fig. 5.21	Variation of Water Content with Time for S4 Mixed with VC .....	131
Fig 5.22	Variation of Evaporation Loss with Time for S1.....	132
Fig. 5.23	Variation of Evaporation Loss with Time for S2.....	133
Fig. 5.24	Variation of Evaporation Loss with Time for S3.....	134
Fig. 5.25	Variation of Evaporation Loss with Time for S4.....	135
Fig 5.26	SWRC for S1 Mixed with CP.....	137
Fig 5.27	SWRC for S2 Mixed with CP.....	137
Fig 5.28	SWRC for S3 Mixed with CP.....	138
Fig 5.29	SWRC for S4 Mixed with CP.....	139
Fig 5.30	SWRC for S1 Mixed with CC.....	140
Fig 5.31	SWRC for S2 Mixed with CC.....	140
Fig 5.32	SWRC for S3 Mixed with CC.....	141
Fig 5.33	SWRC for S4 Mixed with CC.....	141
Fig 5.34	SWRC for S1 Mixed with VC.....	142
Fig 5.35	SWRC for S2 Mixed with VC.....	143
Fig 5.36	SWRC for S3 Mixed with VC.....	143
Fig 5.37	SWRC for S4 Mixed with VC.....	144
Fig. 5.38	Effect of Coir Pith on pH .....	149
Fig. 5.39	Effect of Coir Pith on Organic Carbon.....	149
Fig. 5.40	Effect of Coir Pith on Nitrogen .....	150
Fig. 5.41	Effect of Coir Pith on Phosphorous.....	150

Fig. 5.42	Effect of Coir Pith on Potassium .....	151
Fig. 5.43	Effect of Coir Pith on Calcium .....	151
Fig. 5.44	Effect of Coir Pith on Cation Exchange Capacity .....	152
Fig. 5.45	Effect of Coir pith Compost on pH value.....	154
Fig. 5.46	Effect of Coir pith Compost on Organic Carbon .....	154
Fig 5.47	Effect on Coir pith Compost on Nitrogen .....	155
Fig. 5. 48	Effect of Coir pith Compost on Phosphorous .....	155
Fig. 5.49	Effect of Coir pith Compost on Potassium.....	156
Fig. 5.50	Effect of Coir pith Compost on Calcium.....	156
Fig. 5.51	Effect of Coir pith Compost on Cation Exchange Capacity.....	157
Fig. 5.52	Effect of Vermi Compost on pH .....	159
Fig. 5.53	Effect of Vermi Compost on Organic Carbon.....	159
Fig. 5.54	Effect of Vermi Compost on Nitrogen .....	160
Fig. 5.55	Effect of Vermi Compost on Phosphorous.....	160
Fig. 5.56	Effect of Vermi Compost on Potassium .....	161
Fig. 5.57	Effect of Vermi Compost on Calcium.....	161
Fig. 5.58	Effect of Vermi Compost on Cation Exchange Capacity .....	162
Fig 5.59	Effect of Admixtures on Hydraulic Conductivity of S1.....	165
Fig 5.60	Effect of Admixtures on Hydraulic Conductivity of S2.....	166
Fig 5.61	Effect of Admixtures on Hydraulic Conductivity of S3.....	167
Fig 5.62	Effect of Admixtures on Hydraulic Conductivity of S4.....	167
Fig. 5.63	Experimental Set up (3 months after Planting).....	178



## **1.1 GENERAL**

Soil moisture plays a cardinal role in sustaining ecological balance and agricultural development. Unfortunately this resource is finite and its usage has not been very prudent. In spite of several water management programs organized in this country, the actual water utilized in agriculture is only one third of the total utilizable surface and ground water resources. Therefore there is a distinct need for a critical review and proper planning for the optimal utilization of water for crop production. The different physical processes making up the soil water balance are infiltration from rainfall or irrigation, redistribution of the infiltrated water in the soil water zone, plant water uptake mainly in the form of actual evaporation and percolation out of or capillary rise into the reservoir of soil water.

The better utilization of rain fall, irrigation facilities and effective control of soil erosion and run off depend largely on the water retention characteristics and erodibility indices of the soil. Soil texture, organic matter and cation exchange capacity to a large extent determine the water retention/ release and infiltration rate in soil (Sharma and Verma 1972; sharma et al. 1987). The water movements in the unsaturated zone, together with the water holding capacity of this zone, are very important for the water demand of the vegetation, as well as for the recharge of the ground water storage. The water that falls on the land or added to a soil by irrigation moves in a number of directions. In vegetated areas, 5 – 40% is usually intercepted by plant foliage and returns to the atmosphere by evaporation without ever reaching the soil. In some evergreen forest areas, one third to one half the precipitations is intercepted and does not reach the soil. In level areas with friable soils, most of the added water penetrates the soil. But in rolling to hilly areas, especially if the soil is

not loose and open, considerable run off and erosion take place, thereby reducing the proportion of water that can percolate into the soil.

Once the water penetrates the soil, part of it is subjected to downward percolation and eventual loss from the root zone as drainage occurs. In humid areas, up to 50% of the precipitation may be lost as drainage water. However, during periods of low rainfall, some of this downward percolating water may later move up into the plant root zone by capillary aeration, and thereby become available for plant absorption.

Water is the major input for the growth and development of all types of plants. Plants absorb water. The availability of water, its movement and its retention are governed by the properties of soil. The properties like bulk density, mechanical composition, hydraulic conductivity etc. depend on the nature and formation of soil and land use characteristics in addition to the weathering processes and the geological formations.

It is essential to maintain readily available water in the soil if crops are to make satisfactory growth. The plant growth may be retarded if the soil-moisture is either deficient or excessive. If the soil moisture is only slightly more than the wilting coefficient, the plant must expend extra energy to obtain it and will not grow healthy. Similarly, excessive flooding fills the soil pores with water, thus driving out air. Since air is essential for satisfactory plant growth, excessive water supply retards plant growth. The optimum moisture percentage is thus that which leads to optimum growth of the plant. When watering is done, the amount of water supplied should be such that the water content is equal to the field capacity. 'Field Capacity' (FC) is the amount of water remaining in the soil after all gravitational water has drained. Water will gradually be utilized consumptively by plants after the water application, and the soil moisture will start falling. When the water content in the soil reaches a specific value, called the Permanent Wilting Point (PWP), fresh dose of irrigation may be done so that water content is again raised to the field capacity of soil.

Moisture conservation and efficient utilization of rainfall are important for the successful production of crops in dry land agriculture. Soils differ among themselves in some or all the properties depending on the differences in the genetic

and environmental factors. They serve as a reservoir of nutrients and water, required for crops. The entry and storage of rain water in soil depend upon soil characteristics. According to Dr. H.H. Bennet, “Soil without water is desert and water without soil is useless”. The problem of conserving moisture is of paramount importance in the extensive regions of low and uncertain rainfall. The key to water conservation is the utilization and treatment of land according to its water retention capabilities.

Study of soil and its water holding capacity is essential for the efficient utilization of irrigation water. Hence identification of geotechnical parameters which influence the water retention capacity and the method of adding admixtures to improve the retention capacity of soil, play an important role in irrigation engineering. Coir pith, Coir Pith Compost and Vermi Compost are good admixtures for improving the water retention capacity as well as nutrients of the soil. India is one of the leading countries of the world in area and production of coconuts. The coconut husk finds numerous applications due to its fibrous structure and resilience. Coir pith is a waste product produced during the process of extraction of fibre from coconut husk which contains one third of fibre and two third of pith. Thus for every tonne of fibre about 2 tonnes of coir pith waste is generated. This is mostly unutilized at present and poses a great problem to the fibre manufacturing units as it occupies large area due to its fluffy nature ( dry density = 0.2gm/cc). Apart from space problem it also poses environmental problems due to fire hazards and pollution. The adverse effects of acidic nature can be mitigated by rinsing it with water three to four times.

Although several methods have been suggested for the disposal and utilization of coir pith, only a few have been successful and only a nominal part of the total production could be successfully made use of. This is mainly due to economic reasons, restricted demands for the products and finally for the lack of appropriate technology developed for its proper use.

In spite of the above limitations of coir pith, it is possible to convert this waste into wealth. This can be done by proper exploitation of its useful properties viz. phenomenally high water holding capacity, low bulk density, excellent aeration, good hydraulic conductivity, high infiltration rate, inbuilt slow release mechanism

and some macro and micro nutrients content. All the above properties clearly point to its potential use in agriculture.

Composted coir pith is being widely used along with organic supplements for many crops especially in Horticulture and Floriculture. Composted coir pith is highly beneficial in improving crop productivity in plants by raising the water holding capacity and leading to a high conversion ratio. Moreover, its ability in management of certain root diseases has also been well recognised. Now several techniques have been perfected to convert it in to useful products. Vermi Compost is the excreta of the earth worm which is rich in humus. It increases the aeration porosity and provides moderate water holding capacity and increases the drainage in heavy soils.

The above three admixtures increase in addition to water holding capacity, the nutrient contents favourable to the growth of plants and also make changes in hydraulic conductivity favourable to plant growth.

In this study investigations were carried out to determine the functional properties like water holding capacity and hydraulic conductivity and chemical properties of soils from various locations of Trivandrum district without additives and with additives to improve the above properties. The results of the investigations are used to suggested a suitable irrigation schedule for soils with and without admixtures for the efficient utilization of irrigation water.

The contents of various chapters of this thesis are briefly described below.

**Chapter 1** presents the need of water for plant growth and the significance of proper planning for the optimum use of water for crop production and the studies required on the soil to assess the water retention characteristics.

**Chapter 2** presents the review of the investigations by earlier research workers. The different methods of irrigations used and the soil classification methods are described. The soil physical properties like texture, structure, bulk density and soil moisture properties like evaporation, field capacity, permanent wilting point, hydraulic conductivity and the parameters which affect the chemical properties are discussed. The general properties of the admixtures used here to improve the above properties are also mentioned.

**Chapter 3** describes in detail the materials used, their physical and chemical properties and also the different methods used for this investigation including measurement of soil moisture tension using pressure plate apparatus.

**Chapter 4** gives a detailed description of the investigations carried out on untreated soil. Based on the investigation, the results obtained are discussed and a method for irrigation scheduling is suggested for the better utilization of water.

**Chapter 5** discusses in detail the studies made on soils treated with admixtures. The improvements in the functional and chemical properties due to the addition of admixtures are described. From the results, the percentage of admixture required to maintain a particular water content for a particular period and irrigation interval for the better utilisation of water are suggested.

**Chapter 6** presents the conclusions derived, methods and procedures that have been established from the detailed investigations for the efficient use of irrigation water.

---

## **LITERATURE REVIEW**

---

### **2.1 INTRODUCTION**

Plant growth depends on the use of two important natural resources, soil and water. Soil provides the mechanical and nutrient support necessary for plant growth. Water is the major input for the growth and development of all types of plants. Plants remove water. The availability of water, its movement and its retention are governed by the properties of soil. The properties like bulk density, mechanical composition, hydraulic conductivity etc depends on the nature and formation of soil and land use characteristics in addition to the weathering processes and the geological formations. Effective management of the resources for crop production requires the need to understand relationship between soil, water and plants. Study of soil and its water holding capacity is essential for the efficient utilization of irrigation water. Hence identification of geotechnical parameters which influences the water retention capacity and the method of adding admixtures to improve the retention capacity play an important role in Irrigation Engineering.

### **2.2 IRRIGATION METHODS**

Water is the most crucial input, which needs to be utilized very judiciously. One of the reasons for the low yield is lack of proper irrigation management as the plants are sensitive to availability of soil moisture. The method of irrigation followed affects the distribution and availability of soil water to the plants and ultimately the nutrients uptake and growth.

The surface method of irrigation is usually followed, however in recent years drip irrigation is getting popular due to its several advantages. Except for the comparatively higher initial cost, the advantages include saving in labour, water and power, immediate response to crop need, better soil-water-plant

relationship and rooting environment, besides better yield and quality (Capra and Nicosia 1987; Pyle 1985; Smajstrla 1993). Investigations have been carried out for determining the most effective irrigation method for growing crops and it was found that sprinkler and drip irrigation yielded the best pomological effects. Drip irrigation is claimed to be the most effective with excellent water use efficiency (Ozsan et al. 1983). The response of crops to drip irrigation and microjet irrigation has been studied under different locations (Richards and Warnke 1968). Drip and micro-sprinkle irrigation trial was also carried out (Grieve 1988). The studies on efficiency of macro and mini sprinkler irrigation on growth, water use and yield of Hamlin orange (Marler and Davies 1990) and Shamouti orange (Moreshet et al, 1988) were also conducted which led to the conclusion that the micro-sprinkler produced the best results in comparison to the flooding method.

### **2.3 PRECISION FARMING & FERTIGATION**

Precision Farming is a technique used to give crops exactly the right amount of water and fertilizer and nothing more- and to invest in weather forecasting systems, to ensure that agriculture treatments are applied when the chance of runoff from rain fall is the lowest.

Traditional farming methods are slowly giving way to new precision farming that is changing the way the world grows its food. Precision farming according to farmer's gusset is the application of technologies and agronomic principles to manage space and temporal variability associated with the aspects of agricultural production for the purpose of improving crop performance and environmental quality.

Fertigation can be described as the application of plant nutrients in irrigation water to accomplish fertilizer. Fertigation becoming widely accepted in the industry due to the fact that a properly designed system will perform accurately is now economically easy to install, saves time labour and most

importantly the cost. A proper system will eliminate waste, sludge and residues. It allows one to “fine tune” fertility levels, and will monitor the rates of fertilizer being applied. A good system will also address the reduction of fertigation water run off which can be environmentally reused.

## **2.4 CLASSIFICATION OF SOIL**

Soils seldom exist in nature separately as sand, gravel or any other single component; they are usually found as a mixture with varying proportions of particles of different sizes. A soil classification system is therefore essential to define the soil property. Investigations relative to the field of irrigation have two objectives, namely, suitability of soil for the construction of dams and other kinds of hydraulic structures, and the effect on fertility of soil when it is irrigated. Soil survey and soil classification are also done by agricultural departments from the point of view of suitability of the soil for crops and its fertility. Each of these agencies has adopted different systems for soil classifications.

### **2.4.1 Particle size Classification**

In this classification system, soil is classified in to four broad groups, namely, gravel, sand, silt size and clay size. Some of the classification systems based on particle size are:

- (i) U.S. Bureau of soil classification
- (ii) International classification
- (iii) M.I.T. classification
- (iv) Indian standard classification

These four systems are shown in Fig 2.1.



	0.005 mm	0.05	0.10	0.25	0.50	1.0	2.0 mm
Clay (Size)	Silt (Size)	V. F.	Fine	Medium	Coarse	Fine Gravel	Gravel
		Sand					

(a) U.S. Bureau of Soils and PRA Classification

	0.0002	0.0006	0.002	0.006	0.02	0.05	0.1	0.2	0.5	1.0	2.0 mm
Ultra Clay	F	C	F	C	F	C	F	M	C	V.C.	Gravel
(Colloids)	Clay		Silt		MO (Majla)		Sand				

(b) International Classification

	0.0002	0.006	0.02	0.06	0.2	0.6	2.0 mm
Clay (Size)	Fine	Med.	Coarse	Fine	Med.	Coarse	Gravel
(Colloids)	Silt (Size)			Sand			

(c) M.I.T Classification

	0.002 mm	0.075	0.425	2	4.75	20	80	300
Clay (Size)	Silt (Size)	Fine	Med.	Coarse	Fine	Coarse	Cobble	Boulder
		Sand			Gravel			

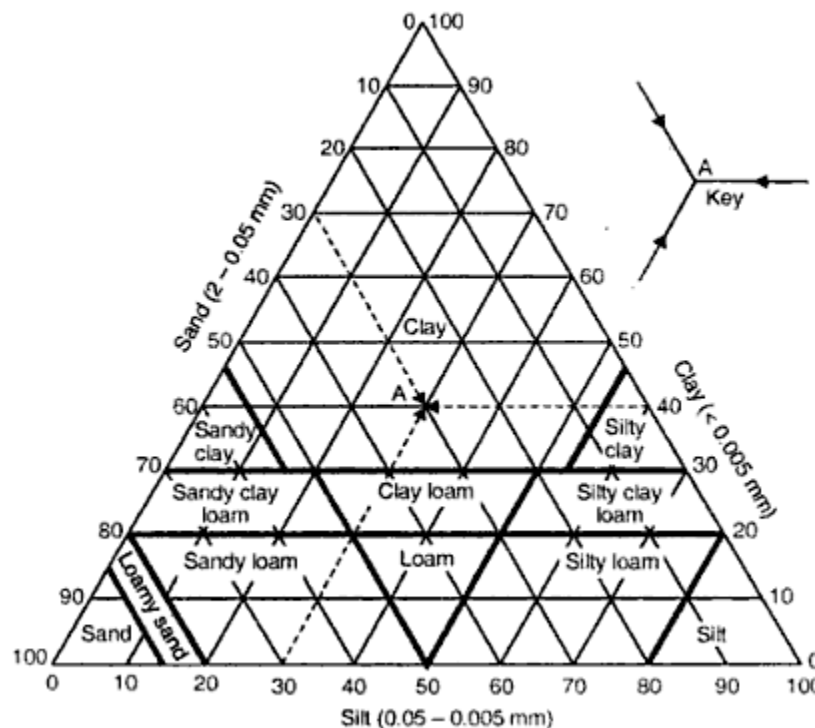
(d) I.S Classification (IS : 1498-1970)

**Fig. 2.1 Grain Size Classification Scale**

The behaviour of fine grained soil depends on its plasticity characteristics; coarse grained soil, on the other hand, depends mainly on particle size. Thus these classification systems are more useful for coarse grained soil.

### 2.4.2 Textural Classification

The textural classification incorporates only particle size. In soil engineering, the term textural classification is used in a restricted sense. The triangular classification system suggested by the U.S. Public Road Administration is shown in Fig 2.2.



**Fig 2.2 Textural Classification Chart**  
(Adapted from U.S. Public Road Administration)

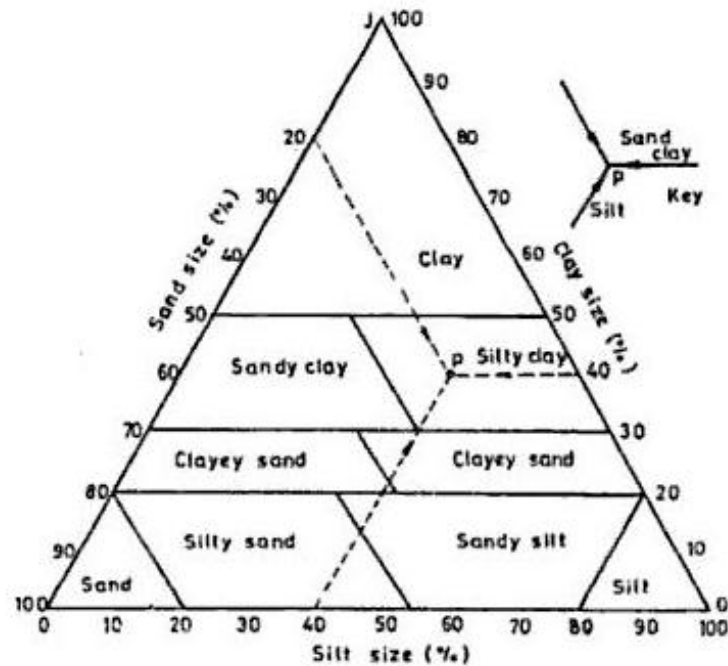
In this classification system, the percentage of three constituents, namely sand (size 0.05 to 2.0mm), silt (size 0.005 to 0.05mm) and clay (size less than 0.005mm) are plotted along the three sides of an equilateral triangle. The classification system assumes that the soil does not contain particles larger than 2.0mm. However, if the soil contains soil particles larger than 2.0mm, a correction is required to sum the percentage of sand, silt and clay to 100%. Further classification of the given soil is based on the corrected percentages.

The Mississippi River Commission (USA) has modified the above triangular classification system by eliminating ‘Loam’ as it is generally used by agricultural engineering and it is shown in Fig 2.3. Soil texture can have a profound effect on many other properties and is considered among the most important physical properties. Texture is the proportion of three mineral particles, sand, silt, and clay, in a soil. These particles are distinguished by size, and make up the fine mineral fraction (Table 2.1).

**Table.2.1. Diameter and appropriate size of four types of soil particles**

Soil Particle	Diameter (mm)
Gravel	> 2.0
Sand	0.05-2.0
Silt	0.002-0.05
Clay	< 0.002

Particles over 2mm in diameter (the ‘coarse mineral fraction’) are not considered in texture, though in certain cases they may affect water retention and other properties. The relative amount of various particle sizes in a soil defines its texture, i.e., whether it is a clay loam, sandy loam or other textural category (Fig. 2.3).



**Fig 2.3 Modified Triangular Chart**

Texture is the result of ‘weathering’, the physical and chemical breakdown of rocks and minerals. Because of differences in composition and structure, materials will weather at different rates, affecting a soil’s texture. For example, shale, an easily weathered rock, forms clay-rich soils, whereas granite, a slow weathering rock, usually forms sandy, coarse soils. Since weathering is a relatively slow process, texture remains fairly constant and is not altered by management practices.

## **2.5 SOIL, WATER AND PLANT RELATIONSHIPS**

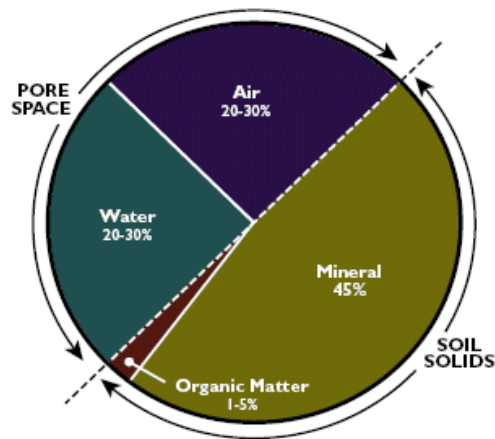
Plant growth depends on the use of two important natural resources, soil, and water. Soil provides the mechanical and nutrient support necessary for plant growth. Water is essential for plant life processes. Effective management of these resources for crop production requires the understanding of relationships between soil, water, and plants. Knowledge about available soil water and soil texture will lead to the decision regarding what crops to plant and when to irrigate.

Agricultural Engineering deals with both the agronomic and engineering aspects of soil. They are concerned primarily with soil properties that influence the engineering phase of tillage, erosion, drainage and irrigation. For crop production, the porosity, soil temperature, soil moisture, size and amount of aggregates, plant nutrient availability and level of biological activity are most important.

## **2.6 SOIL PHYSICAL PROPERTIES**

### **2.6.1 Soil Composition**

Soil is composed of minerals, soil organic matters (SOM), water and air as shown in Fig 2.4. The composition and proportion of these components greatly influence soil physical properties, including texture, structure and porosity, the fraction of pore space in a soil. In turn, these properties affect air and water movement in the soil, and thus the soil’s ability to retain the water. The amount of water and air present in the pore spaces varies over time in an inverse relation. This means that for more water to be contained in the soil there has to be less air. The percentage proportions of variable particle size fractions viz gravel, sand, silt and clay of soils have direct relationship between the hydraulic conductivity and water retention.

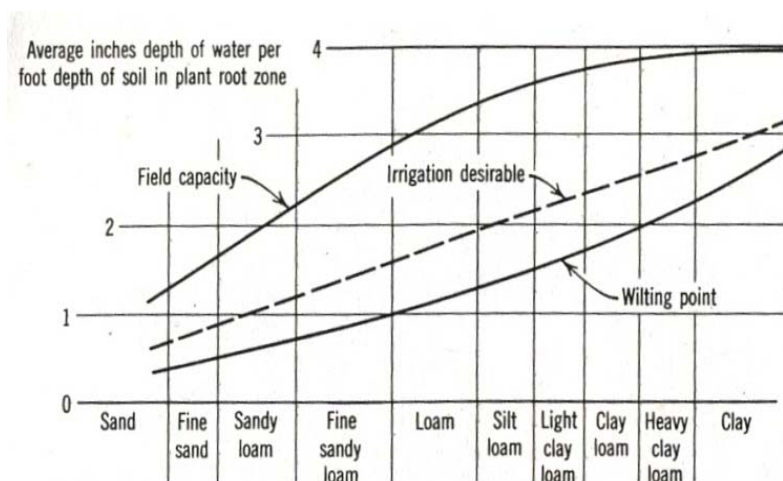


**Fig 2.4 The four components of soil. Minerals and SOM make up the solid fraction, whereas air and water comprise the pore space fraction. A typical agricultural soil is usually around 50% solid particles and 50% pores. (Source: Buckman and Brady, 1998)**

### 2.6.2 Soil Texture

Soil texture has a profound effect on many other properties and is considered among the most important physical properties. Soil texture is determined by the size of the particles that make up the soil. Texture is the proportion of three mineral particles, sand, silt, and clay, in a soil. Clay is an important soil fraction because it has the most important influence on such soil behaviour as water holding capacity.

The effect of soil texture on water holding capacity is shown in a simplified form in Fig. 2.5.



**Fig 2.5 Simplified Comparison of the Water Holding Characteristics of different Textured Soils (Courtesy U. S. Department of Agriculture, 1955)**

### 2.6.3 Soil Structure

Soil structure is the arrangement and binding together of soil particles such as sand, silt, clay, organic matter and fertilizers into larger clusters, called aggregates. Soil structure also refers to the arrangement of these aggregates separated by pores and cracks as shown in Fig. 2.6. Soil structure is an important characteristic used to classify soils and heavily influences agricultural productivity and other uses. The principal forms of soil structure are platy, prismatic, columnar, blocky and granular. Aggregated soil types are generally the most desirable for plant growth. Soil structure refers to the degree to which individual particles are grained together to form aggregates. Aggregation has a pronounced effect on soil properties like erodibility, porosity, permeability, infiltration and water holding capacity. Soil consistency varies with texture, structure, organic matter, percentage of colloidal material and type of clay mineral.

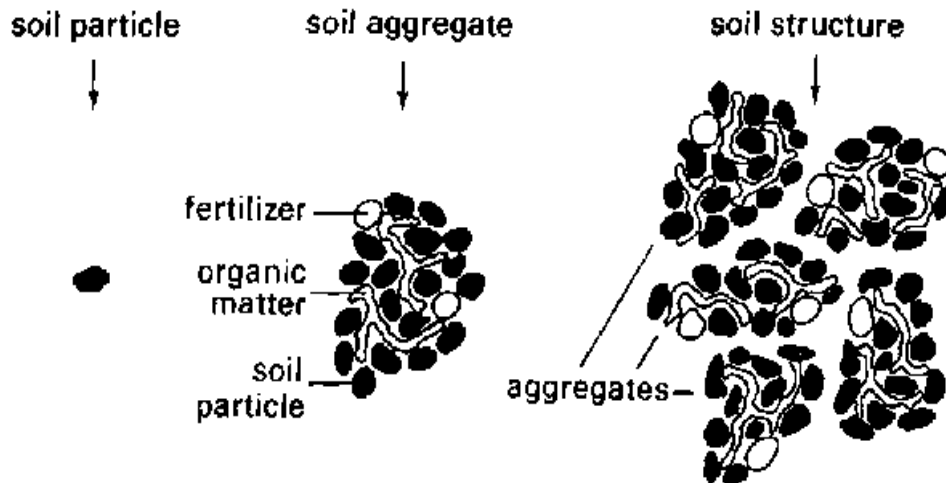
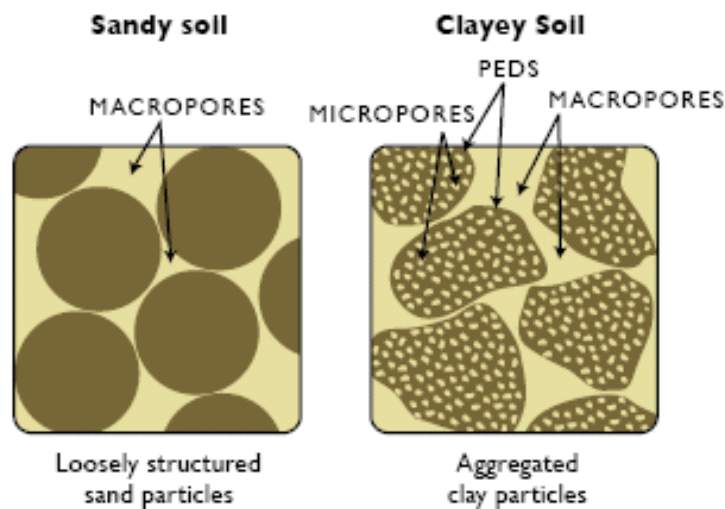


Fig 2.6 Soil Structure

### 2.6.4 Bulk Density and Porosity of Soil

The soil bulk density is important because it gives a measure of the porosity of the soil. Coarse-textured soils have many large (macro) pores because of the loose arrangements of large particles with one another. Fine textured soils are more tightly arranged and have more small (micro) pores as shown in Fig 2.7. Macropores in fine-textured soils exist between aggregates. Because fine-textured soils have both macro and micropores, they generally have a greater total porosity than coarse-textured soils.



**Fig 2.7 Generalized porosity in sandy and clayey soil**

Soil voids are divided arbitrary in to aeration porosity and capillary porosity. Aeration porosity is the percentage of pore space filled with air after the soil has drained to field capacity. Capillary porosity is the percentage of pore space that may be occupied by capillary water. Aeration porosity influences plant growth, permeability and density. The quantity of air in the soil is continuously changing because of factors like climate, tillage, tamping of livestock, plant roots and biological activity. Porosity changes in general with soil texture and structure. Sand and organic soils have high aeration porosity and clay has low aeration porosity. But clay has high total porosity.

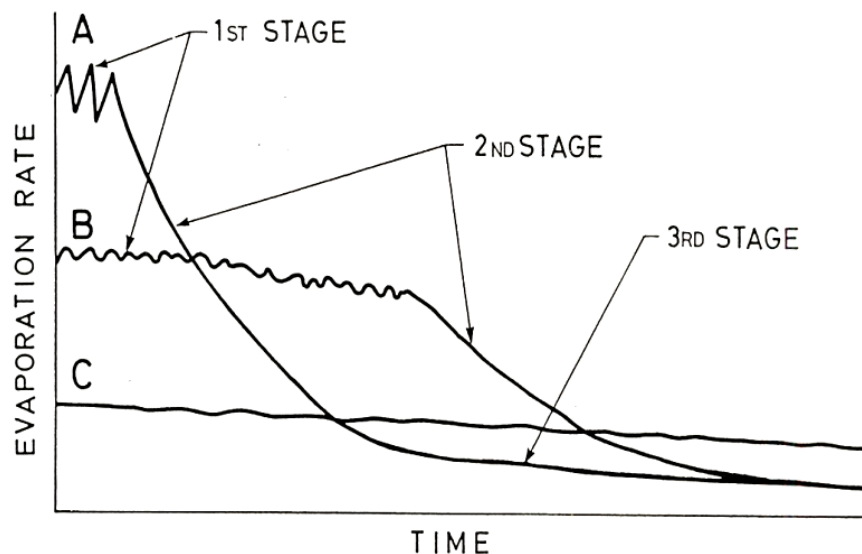
## **2.7. SOIL MOISTURE PROPERTIES**

### **2.7.1 Evaporation**

Two types of water vapor movement occur in soils, internal and external. Internal movement takes place within the soil, that is, in the soil pores. External movement occurs at the land surface, and water vapor is lost by surface evaporation.

According to various estimates, soil water loss by evaporation from arable land is as large as transpiration in humid areas, and in semiarid areas up to 75 percent of the total rainfall. Therefore, evaporation control is one of the most important objects of soil management aimed at improved water supply to arable crops. The drying process of initially wet soils has been divided in to three successive stages (Fig. 2.8). The first stage is that of rapid loss of water where the capillary flow to the

soil surface never fails to meet the evaporative demand of the environment. The second stage is one of rapid decline in the rate of water loss as the soil surface dries. The atmospheric conditions are no longer as important as the ability of the soil to conduct water to the soil surface. The third stage is that of low and nearly constant evaporation rates, which are only slightly dependent upon air and soil surface conditions. The water loss is then 1mm per day or less. The theory of the three stages of evaporation process has been reviewed by Lemon (1956) and by Idso et al. (1974).



**Fig. 2.8 Schematic Course of Evaporation from an Initially Wet Soil under Different Conditions**

- A. High evaporative demand brings about a rapid formation of a dry surface layer and rapid decline in the rate of evaporation.
- B. Low evaporative demand lengthens the duration of the first stage. In the long run the cumulative loss of water approaches that of case A and may exceed it in specific cases.
- C. A straw mulch restricts effectively the transfer of heat to soil and of vapour from soil.

### 2.7.2 Water Retention Capacity of Soil

Soils can process and contain considerable amounts of water. They can take in water, and will keep doing so until they are full, or the rate at which they can transmit water into, and through, the pores is exceeded. Some of this water will steadily drain through the soil (via gravity) and end up in the waterways and streams. But much of it will be retained, away from the influence of gravity, for use of plants and other organisms to contribute to land productivity and soil health. The spaces

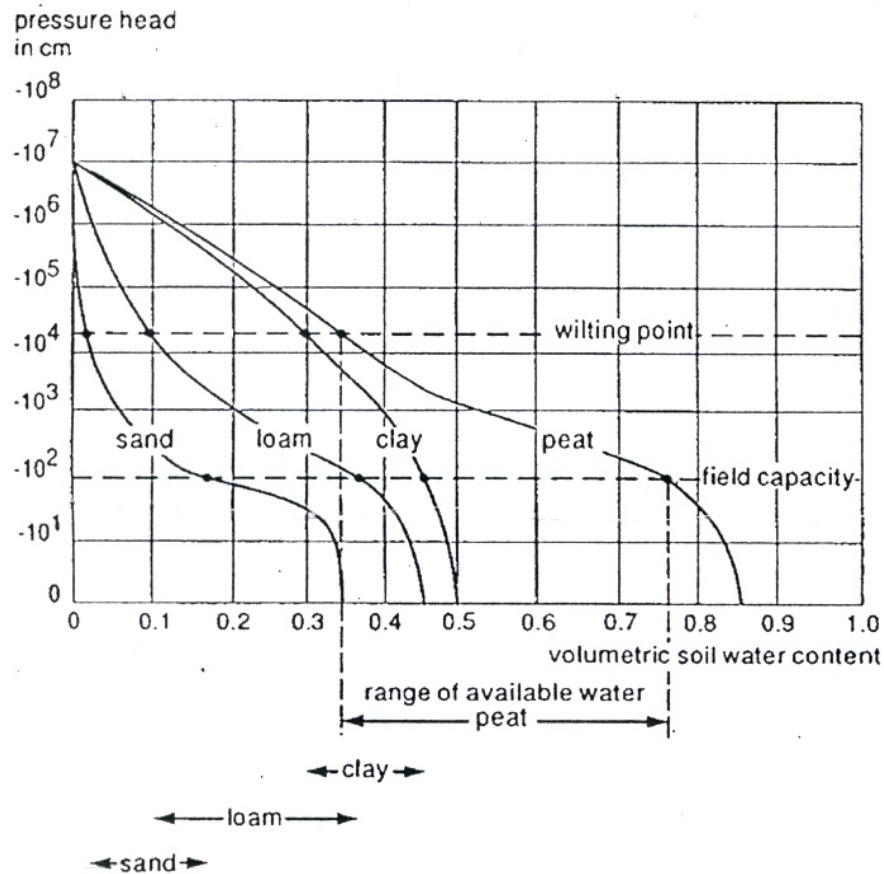


that exist between soil particles, called pores, provide for the passage and/or retention of gases and moisture within the soil profile. The ability of soil to retain water is strongly related to particle size. Water molecules hold more tightly to the fine particles of a clay soil than to coarser particles of a sandy soil, so clays generally retain more water (Leeper and Uren, 1993). Conversely, sands provide easier passage or transmission of water through the profile. Clay type, organic content and soil structure also influence soil water retention (Charman & Murphy 1977). Soil water retention is essential to life. It provides an ongoing supply of water to plants between periods of replenishment (infiltration) so as to allow their continued growth and survival.

During a heavy rain or while being irrigated, a soil may become saturated with water and ready downward drainage will occur. At this point, the soil is said to be saturated with respect to water and at its maximum retentive capacity. When the pressure head of the soil-water changes, the water content of the soil will also change. The graph representing the relationship between pressure head and water content is generally called the 'soil-water retention curve' or the soil moisture characteristic'. Applying different pressure heads, step by step, and measuring the moisture content allows us to find a curve of pressure head,  $h$ , versus soil-water content,  $\theta$ . The pressure heads vary from 0 (for saturation) to  $10^7$  cm (for oven-dry conditions). In analogy with pH, pF is the logarithm of the tension or suction in cm of water. Thus

$$pF = \log | h |$$

Typical water retention curves of four standard soil types are shown in Fig. 2.9.



**Fig. 2.9 Soil-Water Retention Curves for Four different Soil Types and their Ranges of Plant Available water.**

### 2.7.3 Field Capacity

The term 'field capacity' corresponds to the moisture conditions in a soil after two or three days of free drainage, following a period of thorough wetting by rainfall or irrigation. The downward flow becomes negligible under these conditions. For practical purposes, field capacity is often approximated by the soil-water content at a particular soil-water tension.

Following the rain or irrigation, there will be continued relatively rapid downward movement of some of the water in response to the hydraulic gradient. After two or three days, this rapid downward movement will become negligible. The soil is then said to be at its field capacity. At this time, water has moved out of the macropores, and its place has been taken by air. The micropores or capillary pores are still filled with water and will supply the plants with the moisture needed. The matric potential will vary slightly from soil to soil but generally ranges from -0.1 to -

0.3 bar, assuming drainage in to a less moist zone of similar porosity. Moisture movement will continue to take place, but the rate of movement (unsaturated flow) is slow because it now is due primarily to capillary forces, which are effective only in micropores.

#### **2.7.4 Permanent Wilting Percentage or Wilting Coefficient**

The 'wilting point' or 'permanent wilting point' is defined as the soil water condition at which the leaves undergo a permanent reduction in their water content (wilting) because of a deficient supply of soil water, a condition from which the leaves do not recover in an approximately saturated atmosphere overnight (Leeper & Uren 1993). The permanent wilting point is not a constant, because it is influenced by the plant characteristics and meteorological conditions. As plants absorb water from soil, they lose most of it through evaporation at the leaf surfaces (transpiration). Some water also is lost by evaporation directly from the soil surface. These two losses occur simultaneously, and the combined loss is termed evapotranspiration.

As the soil dries up, plants begin to wilt to conserve moisture during the daytime. At first the plants will regain their vigor at night, but ultimately they will remain wilted night and day. Although not dead, the plants are now in a permanently wilted condition, and will die if water is not provided. Under this condition, a measure of soil water potential shows a value of about -15 bars for most crop plants. The soil moisture content of the soil at this stage is called wilting coefficient or permanent wilting percentage. The water remaining in the soil is found in the smallest of the micropore and around individual soil particles.

#### **2.7.5 Available water**

The amount of water held by a soil between field capacity and wilting point is defined as the amount of water available for plants. Below the wilting point, water is strongly bound to the soil particles. Above field capacity, water either drains from the soil without being intercepted by roots, or too wet conditions cause aeration problems in the root zone, which restricts water uptake. The ease of water extraction by roots is not the same over the whole range of available water. At increasing desiccation of soil, the water uptake decreases progressively. For optimum plant production, it is better not to allow the soil to dry out to the wilting point.

### **2.7.6 Hygroscopic Coefficient**

As soil moisture is lowered below the wilting point, the water molecules that remain are very tightly held, mostly being adsorbed by colloidal soil surface. This state is approximated when the atmosphere above a soil sample is essentially saturated (98% relative humidity) with water vapor and equilibrium is established. The water is held so tightly (-31 bars) that much of it is considered nonliquid and can move only in the vapor phase. The moisture content of the soil at this point is termed the hygroscopic coefficient. Soils high in colloidal materials will hold more water under these conditions than will sandy soils and those low in clay and humus.

### **2.7.7 Hydraulic Conductivity**

The rate of movement of water within the soil differs for different types of soil and the hydraulic conductivity has influence on the water retention characteristics, ie field capacity and available water. The texture and structure of soils are the properties to which hydraulic conductivity is most directly related. Sandy soils generally have higher saturated conductivities than finer textured soils. The clay percentage was negatively related to the saturated hydraulic conductivity. Any factor affecting the size and configuration of soil pores will influence hydraulic conductivity. The total flow rate in soil pores is proportional to the fourth power of the radius.

## **2.8 SOIL CHEMICAL PROPERTIES**

### **2.8.1 Exchange Capacity**

Most chemical interactions in the soil occur on colloid surfaces because of their charged surfaces. Due to their chemical make-up and large surface area, colloids have charged surfaces that are able to sorb, or attract, 'ions' (charged particles) within the soil solution. The soil's ability to adsorb and exchange ions is its exchange capacity. Although both positive and negative charges are present on colloid surfaces, soils of this region are dominated by negative charges and have an overall (net) negative charge. Therefore, more cations are attracted to exchange sites than anions, and soils tend to have greater cation exchange capacities (CEC) than

anion exchange capacities (AEC). Fine-textured soils usually have a greater exchange capacity than coarse soils because of a higher proportion of colloids.

### **2.8.2 Soil pH**

Soil pH refers to a soil's acidity or alkalinity and is the measure of hydrogen ions ( $H^+$ ) in the soil. A high amount of  $H^+$  corresponds to a low pH value and vice versa. The pH scale ranges from approximately 0 to 14 with 7 being neutral, below 7 acidic, and above 7 alkaline (basic). Soil pH can affect CEC and AEC by altering the surface charge of colloids. A higher concentration of  $H^+$  (lower pH) will neutralize the negative charge on colloids, thereby decreasing CEC and increasing AEC. The opposite occurs when pH increases.

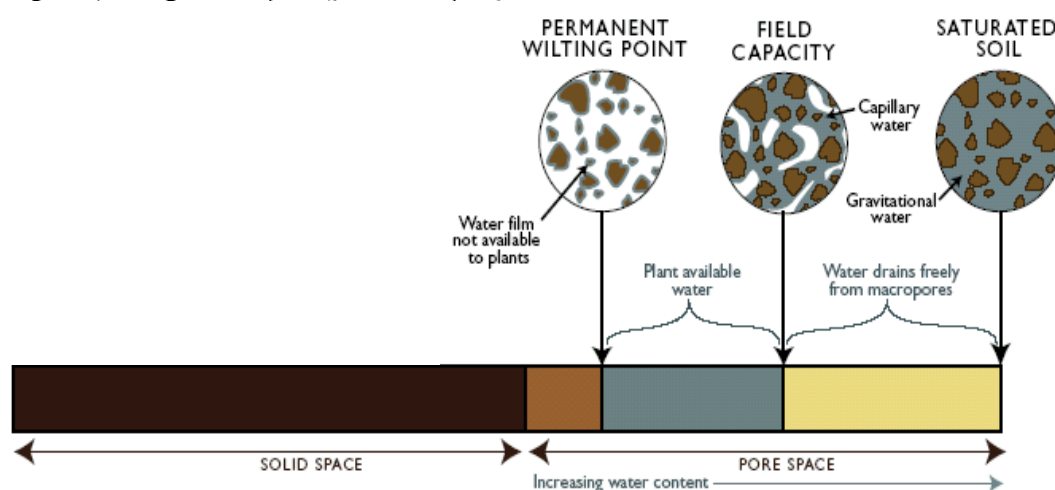
## **2.9 SOIL BIOLOGICAL PROPERTIES**

The soil environment is teeming with biological life and is one of the most abundant and diverse ecosystems on earth. Soil biota, including flora (plants), fauna (animals) and microorganisms, perform functions that contribute to the soil's development, structure and productivity. Soil biological activity is controlled by many factors in the soil. Residue and soil organic material quantity and quality, primarily nitrogen (N) content, are major limiting factors for soil organism activity. Other soil factors that promote activity are adequate levels of oxygen, near-neutral pH, temperatures between 85-95<sup>0</sup>F, and 50-60% moisture (Brady and Weil, 2002; Fig. 2.5). Combinations of these factors will result in maximum activity. Although some organisms have adapted to extreme environmental conditions, overall activity generally diminishes when conditions fall outside these ideal ranges. For example, if a soil becomes too wet, oxygen diffusion is impeded and overall activity slows since oxygen is required by most organisms.

## **2.10 RELATION BETWEEN PLANT AND WATER**

Soil texture, and the properties it influences, such as porosity, directly affects water and air movement in the soil with subsequent effects on the plant water use and growth. The proportion of pores filled with air and water varies, and changes as the soil wets and dries. When all pores are filled with water, the soil is 'saturated' and water within macropores will drain freely from the soil via gravity. 'Field Capacity'

(FC) is the amount of water remaining in the soil after all gravitational water has drained. Remaining water is held in micropores via attractive ‘capillary’ forces or surface tension between water and solids. Unlike gravitational water, capillary water is retained in the soil and can be only removed by plant uptake or evaporation. The amount of capillary water available to plants is the soil’s ‘water holding capacity’ (WHC) or ‘plant available point’ (PAP). This water is available for plant uptake until the ‘permanent wilting point’ (PWP) is reached, a point at which water is held too tightly by the soil for plants to extract it. These concepts are illustrated in Fig 2.10.

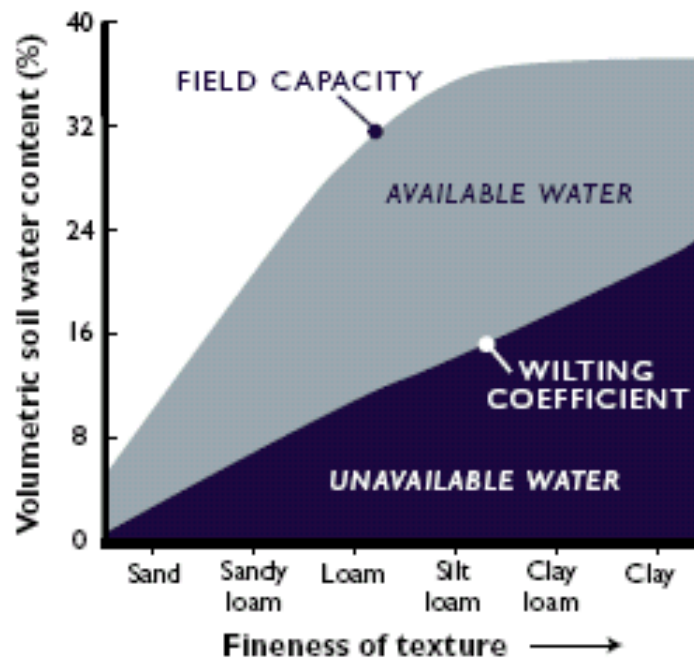


**Fig. 2.10 A soil at saturation, FC and PWP. At saturation, the soil is holding all the water it can. FC is approximately half the water content of saturation. Water content at PWP varies and will depend on the plants’ ability to withstand drought. Note that  $FC - PWP = PAW$ .**

(Source: Mc Cauley , 2005)

The ability of a soil to provide plants with adequate water is based primarily on its texture Fig 2.11. If a soil contains many macropores, like coarse sand, it loses a lot of water through gravitational drainage. Consequently, many pores are open for aeration, and little water remains for plant use before PWP is reached. This can cause drought stress to occur during dry periods. Conversely, a fine-textured soil, such as a clay loam, has mainly micropores which hold water tightly and don’t release it under gravity. Though such soils generally have greater PAW than coarser soils, they are prone to poor aeration and anaerobic (without oxygen) conditions, which can negatively affect plant growth. Well-aggregated, loamy soils are best suited for supplying plants with water because they have enough macropores to provide

drainage and aeration during wet periods, but also have adequate amounts of micropores to provide water to plants and organisms between or irrigation events.



**Fig. 2.11 Relationship of soil texture with soil water content.**

(Source: Buckman and Brady, 1998)

Similarly to clay, SOM is able to hold and retain large quantities of water. SOM aggregates have been shown to increase WHC, infiltration, and porosity, and reduce compactibility. Increasing residue returns and adding organic amendments may be an economically feasible method for improving a soil's WHC, among other benefits.

### 2.10.1 Water Quality

Quality of water refers to the degree of suitability for a specific purpose and it largely depends on its physico-chemical composition. Quality of water for irrigation refers to the degree of suitability for crop growth and it depends on nature of amount of dissolved salts which contain relatively small but important amounts of dissolved salts originating from dissolution weathering rocks and soil and dissolving of lime, gypsum and other salts sources as water passes over or percolates through them.

Depending on the impact of concentration of various ions in water on human health and plants, various standards have been laid down by different agencies. These standards are useful for deciding the suitability of water for drinking and irrigation purposes.

Ground water contamination denotes basically chemical and bacteriological pollution to a degree that inhibits the use of water or that creates an actual hazard to public health through poisoning or the spread of diseases.

Numerous activities including industrial production, agriculture, sewage discharge, urbanization, commercial and residential activities contaminate groundwater sources. The domestic sewage composed of faecal waste, kitchen, laundry waste are the major sources of pollution for the household wells. The important properties of water that determine the quality are physico chemical qualities and bacteriological qualities.

#### ***2.10.1.1 Physico-Chemical Qualities***

##### **Turbidity**

Turbidity is a measure of the resistance of water to the passage of light through it. Turbidity is expressed in parts per million. It is the turbidity produced by one milligram of silica in one liter of water. Turbidity of water sample is commonly determined by Turbidity rod.

##### **Acidity**

Acidity of water is its quantitative capacity to react with a strong base to a designed pH. Strong mineral acids, weak acids such as carbonic acids and acetic acid and hydrolyzing salt such as ferric and aluminum sulphides may contribute to the measured acidity according to the method of determination. Acidity determination is important as it interferes in the treatment of water as in softening, corrodes pipes, and affects aquatic life as in case of discharging waste into a natural source etc.

##### **Alkalinity**

Alkalinity of water is its quantitative capacity to neutralize strong acid to designed pH. Its determination is important in treatment of natural water and waste water. The alkalinity of natural water is due to presence of salts of weak acids like



carbonates, bicarbonates and hydroxides. Bicarbonates represent the major form of alkalinity in natural water. It also contains appreciable amount of  $\text{CO}_3$  and  $\text{OH}$  alkalinity, particularly surface waters blooming with algae. The carbonate alkalinity may be present with either hydroxide or bicarbonate alkalinity. But hydroxide and bicarbonate alkalinity cannot be present together in the same sample.

### **Hardness**

Hardness is the ability of water to cause precipitation of insoluble calcium and magnesium salts of higher fatty acids from soap solutions. The principal hardness causing cations are calcium, magnesium, chlorides and sulphates. It is expressed in terms of equivalent  $\text{CaCO}_3$ . Desirable limit of hardness is 300 mg/l. Higher values are problematic in the sense that it produces encrustation in water supply structures, in the domestic use it affects lathering of detergents.

### **Fluorides**

The concentration of fluoride in drinking water is critical considering health problems related to teeth and bones. High fluoride concentration causes dental fluorosis and skeletal fluorosis whereas the absence or low concentration of fluoride in drinking water results in dental caries in children particularly when the fluoride concentration is less than 0.5 mg/L. In India fluoridation is not needed since we are getting sufficient fluorides from other food items. The recommended desirable limit of fluoride in water is 1 mg/L.

### **Chlorides**

If water containing chloride is titrated with silver nitrate solution, chlorides are precipitated as white silver chloride. Potassium chromate is used as indicator, which supplies chromate ions. As the concentration of chloride ions approaches extinction silver ion concentration increases to a level at which reddish brown precipitate of silver chromate is formed indicating the end point.

### **Iron**

The acceptable limit of iron is 0.3 mg/l and the desirable limit is 1 mg/l. Beyond these limits, taste and appearance are affected. It has adverse effects on domestic uses like staining of plumbing and fixtures, oily appearance on top of water

body, deposits on boiling, colouration to the food prepared, promoting iron bacteria etc.

### 2.10.1.2 Bacteriological Contamination

Varieties of water borne diseases are attributed to untreated or inadequately treated ground water containing pathogenic forms of bacteria. Biological contamination of ground water may occur when human or animal waste enters an aquifer. Standard test to determine the safety of ground water for drinking purposes involves identifying whether bacteria belonging to coliform group are present. The recent faecal pollution of water sources are indicated by the presence of coliform bacteria viz., *Escherichia coli*. The result of coliform test is reported in terms of Most Probable Number (MPN/100ml) of coliform group of organism present in a given volume of water.

For analysis of water quality, standards approved by Bureau of Indian Standards (IS 10500-91) for drinking water are followed. The physical, chemical and bacteriological quality of water should not exceed the limits shown in Table 2.2.

**Table 2.2 Water Quality Standards as approved by Bureau of Indian Standards**

Parameter	Desirable limit	Maximum permissible limit
pH	6.5-8.5	6.5-8.5
Total dissolved solids (mg/l)	500	2000
Turbidity (NTU)	5	10
Total hardness (mg CaCO <sub>3</sub> /L)	300	600
Calcium (mg/l)	75	200
Magnesium (mg/l)	30	100
Total alkalinity (mg CaCO <sub>3</sub> /L)	200	600
Sulphate (mg/l)	200	400
Chloride (mg/l)	250	1000
Fluoride (mg/l)	1	1.5
Iron (mg/l)	0.3	1
Nitrate-N (mg/l)	10	-
Lead (mg/l)	0.05	0.05

Cadmium (mg/l)	0.01	0.01
Zinc (mg/l)	5	15
Copper (mg/l)	0.05	1.5
Total Coliform	NIL	NIL
Faecal Coliform	NIL	NIL

### 2.10.1.3 Irrigation Water Quality

In irrigation agriculture, the quality of water used for irrigation should receive adequate attention. Irrigation water, regardless of its source, always contains some soluble salts in it. Apart from the total concentration of the dissolved salts, the concentration of some of the individual salts, especially those which are most harmful to crops, is important in determining the suitability of water for irrigation. The constituents usually determined by analyzing irrigation water are the electrical conductivity for the total dissolved salts, soluble sodium percentage, sodium absorption ratio, boron content, pH, cations such as calcium, magnesium, sodium, potassium and anions such as carbonates, bicarbonates, sulphates, chlorides and nitrates.

On the basis of suitability of water for irrigation, the water may be classified under three categories, as shown in the Table.2.3

**Table 2.3 Standards for Irrigation waters**

Class	Electrical conductivity (micro-ohm/cm)	Total Dissolved Solids (ppm)	Exchangeable sodium (%)	Chloride (ppm)	Sulphate (ppm)	Boron (ppm)	Remarks
I	0-1000	0-700	0-60	0-142	0-192	0-0.5	Excellent to good

II	1000-3000	700-2000	60-75	142-355	192-480	0.5-2.0	Good to injurious; suitable only with permeable soils and moderate leaching. Harmful to more sensitive crops
III	> 3000	> 2000	> 75	> 355	> 480	> 2.0	Unfit for irrigation.

## 2.11 ADMIXTURES FOR BETTER WATER RETENTION

In real systems, the soil hydrological properties are subject to the influence of climatic and management factors. The incorporation of fresh organic matter modifies the functional properties of the soils. When incorporated into the soil, organic matter undergoes microbe-induced changes, driven by soil structural and micro-environmental factors. As different kinds of organic matter may be added to the soil for agro-environmental purposes, our hypothesis is that they may differently affect both the soil water retention values and their temporal changes.

### 2.11.1 Coir Pith

Coir pith, a highly lignocellulosic material is available in large quantities as a byproduct of the coir industry. This spongy cork like material left to itself is normally resistant to biodegradation. Extraction of 1 kg of coir fibre generates 2 kg of coir pith and in India, an estimated 5,00,000 M T of coir pith is produced per annum.

The nursery and green house industries use significant quantities of sphagnum peat in the formulation of artificial substrates for production of bedding plants. Environmental concern and increasing cost of mined peat have resulted in

plant lovers endeavoring for the development of an alternative to peat. Among various substitutes tried and scientific investigation and research undertaken in the matter, coir based substrates were found to be a suitable alternative to peat for the formulation of substrates for production of bedding plants. There is at present a consistently growing demand for coir dust/pith as a growth medium. Present indications are that this waste material can become an important source of organic matter and an important term of export besides the coir which is now used as geofabric in western countries who are more concerned about the biodegradability of the material and environmental pollution.

The coconut husk finds its noble use due to its fibrous structure and resilience. The coir pith is fibrous in nature and this property improves the physical properties of even the heaviest clay soil and allows free drainage when pith is incorporated as an ameliorant. Because of its sponge like structure, coir pith helps to retain water and improve aeration. It has a density very much lower than that of coir fibre. The specific gravity of air dried pith is only about 0.1 compared to that of the fibre which is about 1 to 1.5. The pith, however, is considerably more water absorbing. It absorbs about 600 to 800 percent by weight of water, whereas the figures for the fibers range over 10 to 40% only.

Characteristics of coir pith:

- High water holding capacity – can hold 6 times or more its weight of water.
- It can hold moisture (therefore nutrients in solution) for longer periods and make it available to the plants when required.
- Excellent drainage, which reduces irrigation that leads to the reduced loss of fertilizers.
- Loose structure provides better aeration and enables better root development.
- Resistant to bacteria and fungal growth, odourless, free from pathogens, weeds and toxins.
- Slow decomposition reduces replacement costs.
- Easier wet ability without adding wetting agents.
- Greater physical resiliency that withstands compression better.

- Ecofriendly, environmentally safe, very economical, user friendly, maintenance free, easily disposable or reusable.

### **2.11.2 Coir pith Compost**

Any organic material having wider C:N ratio offers stiff resistance to microbial degradation which results in setback in the growth of crops temporarily. Reduction of C and increasing N content resulting in narrowing down the C:N ratio is necessary before the organic material is applied to the soil. Composting has been found to be the most useful method among the several methods suggested for narrowing down the C:N ratio. Coir pith compost developed from coir waste is a good organic manure and soil conditioner applicable to agricultural crops. Pithplus, a spawn of edible mushroom *Pleurotus sojar-caju* speeds up the decomposition process and leads to 42% reduction in volume of coir pith. Application of coir pith manure improves the physical and chemical properties of the soil. The properties of coir pith compost are listed below:

- High moisture retention.
- Improves physical and biological condition of soil.
- Improves aeration.
- Reduces frequency of irrigation.
- Enhances strong and healthy root system.
- Excellent medium for plant growth.
- Better yield.

### **2.11.3 Vermi Compost**

Vermi compost is dark brown / black humus like material, soft in feel and free from any foul smell, live weed seeds and other contaminations. It is the excreta of earthworm, which is rich in humus. Mucus like substance coated on each particle, increases aeration in soil, provides excellent water holding capacity and increases drainage in heavy soils. It contains sufficient moisture at the time of packing. The properties of coir pith compost are listed below:

- Improves soil aeration, texture and tilth thereby reducing soil compaction.

- Improves water holding capacity of soil because of its high organic content.
- Promotes better root growth and nutrient absorption.

## 2.12 pH OF SOIL

Soil pH or soil reaction is an indication of the acidity or alkalinity of soil and is measured in pH units. The pH scale goes from 0 to 14 with pH as 7 as the neutral point. Correct pH is essential to ensure proper growing condition and the availability of nutrients. The soil pH and its interpretation is shown in Table 2.4.

**Table 2.4 Soil pH and Interpretation**

5.0	5.5	6.0	6.5	7.0	7.5	8.0
Strongly acidic	Medium acidic	Slightly acidic	Neutral	Neutral	Mildly alkaline	Moderately alkaline

Soil pH influences the solubility of nutrients. It also affects the activity of micro-organisms responsible for breaking down organic matter and most chemical transformations in the soil. Soil pH thus affects the availability of several plant nutrients.

A pH range of 6 to 7 is generally most favorable for plant growth because most plant nutrients are readily available in this range. However, some plants have soil pH requirements above or below this range.

Soils that have a pH below 5.5 generally have a low availability of calcium, magnesium, and phosphorus. At these low pH, the solubility is high for aluminium, iron and boron; and low for molybdenum.

## 2.13 CATION EXCHANGE CAPACITY

Any element with a positive charge is called a cation and in this case it refers to the basic cations, Calcium ( $\text{Ca}^{+2}$ ), Magnesium ( $\text{Mg}^{+2}$ ), Potassium ( $\text{K}^{+}$ ) and Sodium ( $\text{Na}^{+}$ ) and the acidic Cations < Hydrogen ( $\text{H}^{+}$ ) and Aluminium ( $\text{Al}^{+3}$ ). The amount of these positively charged cations a soil can hold is described as cation exchange capacity and is expressed in meq/100gm of soil. The larger the number, the more nutrients the soil can hold. A clay will have a larger CEC than a sandy soil. The CEC gives an indication of the soils potential to hold plant nutrients. Increasing the

organic matter content of any soil will help to increase the CEC since it also holds cations like the clays.

## **2.14 NUTRIENTS OF SOIL**

Efficient, balanced and integrated nutrient management is the key to sustainable food, feed and fibre production, nutritional quality and for maintenance of soil health. A nutrient management plan is defined in the United States Department of Agriculture (USDA) Natural resources Conservation service (NRCS) Standard (590) as, “Managing the amount, source, placement, form and timing of the application of nutrients and soil amendments”. The purpose of the 590 standard is to adequately meet the nutrient needs of the crop to be grown, while minimizing the loss of nutrients to surface and ground water. The purposes of a nutrient management plan are: adequate supply of nutrients for crop production, proper utilization of manure or organic by-products, minimization of agricultural non-point source pollution of surface and ground water resources, and maintenance or improvement of the physical, chemical and biological condition of soil. A nutrient management plan helps the farmers to manage cost-effectively the commercial fertilizer and animal manure inputs and improve the surface and ground water quality of the farm and adjoining areas. A nutrient management plan should consider all possible sources of nutrients including, N contributions from legumes and crop rotations, animal manure and organic by-products, commercial fertilizer, soil nutrient availability, waste water, and irrigation water.

### **2.14.1 Essential Nutrients**

The three major nutrients required for every plant are nitrate nitrogen (N), which promotes foliage growth and increases yield; phosphorous (P) to stimulate root growth; and potassium (K), which hardens tissue and increases resistance to disease. Other nutrients which are essential for the fertility of the soil are Nitrate Nitrogen, Phosphate, Calcium, Magnesium, Manganese, Aluminum, chloride, iron etc. The limits for different nutrient parameters are shown in Table 2.5

**Table 2.5 Limits for different nutrient parameters of soil**

	<b>OC (%)</b>	<b>N (Kg/ha)</b>	<b>P(Kg/ha)</b>	<b>K(Kg/ha)</b>	<b>Ca(Kg/ha)</b>
--	---------------	------------------	-----------------	-----------------	------------------



Low	<0.5	<280	<10	<120	<780
Medium	0.5 – 0.75	280 – 560	10 – 25	120 – 280	780 – 3900
High	>0.75	>560	>25	>280	>3900

### **2.14.1.1 Macro Nutrients**

#### **Nitrogen (N)**

Plants take up more nitrogen than any other nutrient. It is present in amino acids, enzymes, chlorophyll and genes. Nitrogen is needed in highest concentrations in plant parts that are actively growing such as young leaves and fruits (flowers) and root tips. Plants can take up nitrogen in both nitrate and ammonium forms. Toxicity can be a problem withers as a result of too high levels of the ammonium ion, by too much soluble manganese being released as the pH is lowered, or by interference with other nutrients.

#### **Phosphorus (P)**

Present in many forms in soils, phosphorous is essential to photosynthesis and the making of protein and new cells. During periods of rapid shoot and root extension it is vital phosphorous is available, otherwise growth will be stunted. Phosphorous is especially important early in a plant's life for good root system development and successful establishment.

#### **Potassium (K)**

This nutrient is taken up in fairly large amounts by plants. Being a macro element it is required for good plant growth and development increasing vigour, disease resistance and fruit quality. Potassium has role in controlling water movement between cells, as a balancing cation for anions and is used various chemical reactions.

#### **Calcium (Ca)**

Calcium improves the absorption of other nutrients by roots and their translocation within the plant. It activates a number of plant growth regulating enzyme systems, helps convert nitrate-nitrogen into forms needed for protein

formation, is needed for cell wall formation and normal cell division, and contributes to improved disease resistance. Calcium, along with magnesium and potassium, helps to neutralize organic acids, which form during cell metabolism in plants.

### **Magnesium (Mg)**

Magnesium is an essential component of the chlorophyll molecule, with each molecule containing 6.7 percent magnesium. Magnesium also acts as a phosphorus carrier in plants. It is necessary for cell division and protein formation. Phosphorus uptake could not occur without magnesium and vice versa. So, magnesium is essential for phosphate metabolism, plant respiration and the activation of several enzyme systems.

### **Sulphur (S)**

Sulphur is absorbed primarily in the sulfate form ( $\text{SO}_4^{2-}$ ) by plants. It may also enter the leaves of plants from the air as sulfur dioxide gas. It is part of every living cell and required for synthesis of certain amino acids and proteins. Sulphur is also important in photosynthesis and crop winter hardiness. Leguminous plants need sulphur for efficient nitrogen fixation. Sulphur is also important in the nitrate-reductase process where nitrate- nitrogen is converted to amino acids

#### ***2.14.1.2 Micro Nutrients***

### **Iron (Fe)**

Iron is involved in the production of chlorophyll, and iron chlorosis is easily recognised on iron- sensitive crops growing on calcareous soils. Iron also is a component of many enzymes associated with energy transfer, nitrogen reduction and fixation, and lignin formation. Iron is associated with sulphur in plants to form compounds that catalyse other reactions

### **Manganese (Mn)**

Involved in enzyme activation during carbohydrate reduction, chlorophyll and RNA/DNA synthesis and other reactions. Manganese deficiencies mainly occur on organic soils, high-pH soils, sandy soils low in organic matter, and on over-limed

soils. Soil manganese may be less available in dry, well-aerated soils, but can become more available under wet soil conditions when manganese is reduced to the plant-available form. Conversely, manganese toxicity can result in some acidic, high-manganese soils. Uptake of manganese decreases with increased soil pH and is adversely affected by high levels of available iron in soils.

### **Boron (B)**

A primary function of boron is related to cell wall formation, so boron-deficient plants may be stunted. Sugar transport in plants, flower retention and pollen formation and germination also are affected by boron. Seed and grain production are reduced with low boron supply.

### **Zinc (Zn)**

Acts as an enzyme activator in protein, hormone and RNA/DNA synthesis and metabolism; aids in ribosome complex stability. Zinc uptake by plants decreases with increased soil pH. Uptake of zinc also is adversely affected by high levels of available phosphorus and iron in soils

### **Copper (Cu)**

Copper is necessary for carbohydrate and nitrogen metabolism, so inadequate copper results in stunting of plants. Copper also is required for lignin synthesis which is needed for cell wall strength and prevention of wilting. Copper uptake decreases as soil pH increases. Increased phosphorus and iron availability in soils decreases copper uptake by plants.

### **Molybdenum (Mo)**

Molybdenum is involved in enzyme systems relating to nitrogen fixation by bacteria growing symbiotically with legumes. Nitrogen metabolism, protein synthesis and sulfur metabolism are also affected by molybdenum. Molybdenum has a significant effect on pollen formation, so fruit and grain formation are affected in molybdenum-deficient plants. Molybdenum uptake by plants increases with increased soil pH, which is opposite that of the other micronutrients.

## **Chlorine (Cl)**

Because chloride is a mobile anion in plants, most of its functions relate to salt effects and electrical charge balance in physiological functions in plants. Chloride also indirectly affects plant growth by stomatal regulation of water loss. Wilting and restricted, highly branched root systems are the main chloride-deficiency symptoms, which are found mainly in cereal crops. Most soils contain sufficient levels of chloride for adequate plant nutrition. However, chloride deficiencies have been reported on sandy soils in high rainfall areas or those derived from low-chloride parent materials.

### **2.15 PREVIOUS STUDIES**

Bandyopadhyay, S.K and Ray, S.K (1988) of Water Technology Centre, IARI, New Delhi conducted laboratory studies to find out, in quantitative terms, the effect of pure and different mixture of Jalsakthi with sandy loam soil on retention and release of available soil moisture, soil porosity and soil bulk density as compared to those of natural soil. Jalsakthi, a proprietary product jointly developed by the National Chemical Laboratory, Pune and Indian Organic Chemicals Limited, Bombay, is claimed to have outstanding water absorption capacity and may be used as soil amendment for release capacities.

Incorporation of Jalsakthi in increasing amounts with soil progressively reduced soil bulk density and thus increased soil porosity. Addition of Jalsakthi at the rate of 0.6 to 1.0 % to soil increased saturation moisture content by 41 to 46% over that of pure soil. Also, available soil moisture content was increased. Increase in total available soil moisture due to addition of Jalsakthi indicates the possibility of its use to increase retention of rain water in situ for better crop stand under rain fed and delayed irrigation situations.

Fredlund et al (1998) have demonstrated the applications of the soil water characteristic curves (SWCC) for estimation of unsaturated soil properties. It has been opioned that SWCC is an important soil function relating the water content of a soil to its suction. It is a representation of pore size distribution, amount of water content in pores and the stress state of soil and pore water.

Ponzoni, G. and Marchetti, G. (2006) carried out experiments to compare the water retention of two soils belonging to contrasting textural classes, added with different kinds of green manure, with that of non-manure controls. Water retention of the green-manure soils was also measured at subsequent time intervals after GM incorporation. In the green manure soils, the water retention increased in the months following incorporation. Water retention changes for varying green manure types and elapsing times after green manure incorporation may be attributed to different green manure composition and decomposition products.

Krishnamoorthi et al conducted field studies with coir pith and mentioned that the response of turmeric and sunflower, coir pith application was better than farmyard manures. The studies reveal that coir pith blended with NPK can be effectively used in sandy soils and effect is superior than control with NPK alone and comparable with other treatments like manures.

Kumar S., *et al.* (2002) studied the soil profiles developed under different land uses, viz., cultivation, orchards and forests for their water retention characteristics, infiltration and erodability indices in the mid hill region of Himachal Pradesh representing sub-temperate sub-humid climatic zone. Results revealed that land use and physical chemical property, namely, organic carbon, clay, water stable aggregate (WSA) and mean weight diameter (MWD) play a significant and positive role in water retention and erodability indices. Forest soils had higher water retention, infiltration rate, and lower dispersion and erosion ratios than the cultivated and orchard soils.

One of the most important parameters influencing crop production is the water available to plants either by rainfall or through irrigation. The behaviour of the soil water plant system may be considered with a description of the moisture regime existing in the soil. However, it is possible that while the total soil water content in the root zone appears to be adequate for plant growth, the distribution of water in layers of the soil is not optimal. Therefore, continued monitoring of soil moisture constant is of great significance in irrigation management (Jain C.K., Kumar, S. and Nachiappan, P., 1993).

Gajbhiye, K.S (1990) carried out experimental investigations to correlate the water retention at 33 and 1500 KPa tension with important properties of Vertisols and their intergrades occurring around Nagpur region. It was concluded that the water retention is strongly influenced by clay fraction and its associated charge characteristics. The regression equations based on interrelationship with silt and clay fractions would be useful for predicting the water retention property of soil, instead of that based on single factor.

Purandara, B.K and Kumar, C.P (2003) examined the hydrological behaviour of a hard rock catchments characterized by different land covers. The results showed high rates of infiltration and saturated hydraulic conductivity, particularly in forest soils which could be attributed to the presence of macropores as observed during the field investigations. This results in high degree of heterogeneity in catchments responses to rainfall events. This necessitated the determination of 'characteristic' values of hydraulic properties of soils for modeling purposes.

Subbaiah, R (1996) developed a simulation model to forecast the soil moisture status of the soil at the end of every day. The model includes the mechanisms for simulating the root growth and soil water movement. Model inputs and soil and crop parameters are easily attainable so that the model can be adopted to on-farm irrigation scheduling.

Kumar, C.P. and Seth, S.M (2001) carried out field and laboratory studies for determining soil moisture characteristics along the Hindon river in its upstream reach. They proposed an empirical relationship to derive the approximate soil moisture retention curve from saturated hydraulic conductivity data.

Namasivayam, C and Sangeetha, D (2006) conducted studies using coir pith to develop ZnCl<sub>2</sub> activated carbon and applied to the removal of toxic anions, heavy metals, organic compounds and dyes from water. Sorption of inorganic anions such as nitrate, thiocyanate, selenite, chromium (VI), Vanadium (V), Sulfate, molybdate, phosphate and heavy metals such as nickel (II) and mercury (II) has been studied. Removal of organics such as resorcinol, 4 – nitrophenol, catechol, bisphenol A, 2 – aminophenol, quinol, O – cresol, phenol and 2 – chlorophenol has also been investigated. Uptake of acidic dyes such as acid brilliant blue, acid violet, basic dyes

such as direct red 12B, congo red and reactive dyes such as procion red, procion orange were also examined to assess the possible use of the adsorbent for the treatment of contaminated ground water. Favorable conditions for maximum removal of all adsorbates at the adsorbate concentration of 20 mg/L were used. Results show that ZnCl<sub>2</sub> activated coir pith carbon is effective for the removal of toxic pollutants from water.

Nourbakhsh et al (2005) studied the basic soil physical and chemical properties and developed a method to estimate the field capacity and wilting point. The results indicated a strong linear correlation between the field capacity and sand and CEC, and between wilting point and silt and CEC. They found that CEC was a more important factor for estimating field capacity and wilting point than clay and organic matter content, as the former incorporates the effects of both clay and organic matter content.

Rajarithnam, S and Shashirekha.M.N (2007) carried out experiments with coir pith for its potential in serving as a growth substrate for the production of species of oyster mushroom. Amendment of coir pith with rice straw and horse gram plant residue tended to greatly modify the physical characteristics of inoculated mushroom. Changes in cellulose, hemicellulose and lignin contents of coir pith amended with rice straw were studied. Cellulose, hemicellulose and protease enzyme activities in the amended coir pith substrate showed continuous increase from inoculation till the end of fructification, whereas laccase activity decreased during fructification, in consonance with decreased lignin degradation during fructification.

Rathft, L.F et al (1983) conducted studies on soils by suction measurement using pressure plate apparatus. The available water for plants in various types of soils is discuss and mentioned that the available water will depends upon the soil texture and the available water for clayey soils is higher than that of sandy soils.

Savithri and Khan (1994) studied the chemical and physical properties of coir pith and also its effect on the physical, chemical properties and water holding capacity. They mentioned that coir pith can be used effectively in problem soils like sand for improving its functional properties. They also mentioned that it can be used as an effective substitute to farm manures by proper decomposition.

Sharma and Verma (1972) conducted experiments to study the organic carbon, soils texture and cation exchange capacity of soils for better utilization of rain fall, irrigation facilities, effective control of soil erosion and water retention. They reveal that soil texture , organic matter and cation exchange capacity to a large extent determine the water retention / release and infiltration rate in soil.

Thakur et al (2005) conducted studies on the parameters affecting soil-water characteristics curves of fine grained soils. Experiments were conducted to measure the suction of a locally available silty soil and commercially available white clay, using a Dewpoint PotentialMeter (WP4). The results were used to develop soil-water characteristic curves, SWCCs, for these soils and for checking the efficiency of different fitting functions, in high suction ranges. Efforts have also been made to demonstrate the influence of the soil type and dry unit weight on the soil suction. The study brings out the observation that dry unit weight has negligible influence on the soil suction and parameters effecting SWCC.

Rawls et al (1982) conducted soil survey and collected data for 1323 soils from 32 states. From the data, the Brooks and Corey water retention parameters, soil water retention volumes at 0.33 bar and 15 bar, total porosity and saturated conductivities for the major USDA soil textures classes were developed. Also, relationships for predicting water retention volumes for particular tensions and saturated hydraulic conductivities based on soil properties are presented.

## **2.16 NEED FOR THE STUDY**

Water is the major input for the growth and development of all types of plant. The availability of water its movement and its retention are governed by the properties of soil. Because of the growing shortage of water resources, study of soil and its water holding capacity is essential for the efficient utilization of irrigation water. Hence the identification of geotechnical parameters and the methods to improve it by adding admixtures play an important role in irrigation engineering. Measuring soil water content, soil evaporation, soil suction, cat ion exchange capacity are essential to produce more detailed guidelines for vegetation management. By measuring soil water content at field capacity, evaporation losses and the soil suction one can determine the water requirement and there by fix the irrigation scheduling or can design the soil with admixtures corresponding to the



irrigation schedule. Also can determine the changes in the chemical properties of the soil by the addition of admixtures and there by adjust the quantity of fertilizers to be used and to establish methods and procedures for the most efficient use of irrigation water which can increase the command area and can contribute to the prosperity of the country.

## **2.17 OBJECTIVES**

1. To identify the geotechnical parameter which affects the water retention capacity of soil.
2. To improve the water retention properties by proper additives.
3. To determine hydraulic conductivity of soil with and without additives.
4. To study the effect of effluent water before and after planting.
5. To suggest a design procedure for the soils with and without admixture for the efficient utilization of irrigation water.

---

## **MATERIALS AND METHODS**

---

### **3.1. INTRODUCTION**

Study of soil and its water holding capacity are essential for the efficient utilization of irrigation water. Hence identification of the geotechnical parameters which influence the water retention capacity of soil and the methods to improve the same, play an important role in irrigation engineering. In the present study, laboratory investigations have been carried out to determine the field capacity, soil moisture variations due to evaporation losses, nutrient content and hydraulic conductivity of soils collected from various locations in Trivandrum district in Kerala.

Studies were also conducted to assess in quantitative terms, the effect of some admixtures on the retention of available soil moisture as compared to that of normal soil. The effect of different admixtures on properties of soil such as hydraulic conductivity, pH, organic carbon, available nitrogen, cation exchange capacity etc was also investigated. The properties of the water when it passes through different untreated and treated soils were also determined and compared to the water used for irrigation as the water that reaches the root system may be different from the water that is supplied.

### **3.2 MATERIALS USED**

In order to study how the irrigation water passes through the soil fabric and how the retention capacity of each soil type is influenced by its geotechnical properties, soil samples were collected from farm lands of seven different locations in Trivandrum district. The soils were then treated with admixtures like coir pith, coir pith compost and vermi compost to improve the water retention capacity and to identify the parameters that influence the retention.

### 3.2.1 Soils

Bulk samples of soils were collected in jute bags from seven different locations prepared for cultivation, in Trivandrum district viz. Chavadimukku, Choozhatukotta, Kizharoor, Thrikkannapuram, Vilabhagam-Varkala, Njakkad-Varkala and Thiruvallam. Since the soil that is used for cultivation is only the top soil, soil samples were collected from the top 30 cms only. All the samples were air dried and the lumps were broken by pulverising between thumb and fingers. The soil samples collected from the above seven locations were given the following nomenclatures;

Soil S1 -	Chavadimukku
Soil S2 -	Choozhatukotta
Soil S3 -	Kizharoor
Soil S4 -	Thrikkannapuram
Soil S5 -	Vilabhagam-Varkala
Soil S6 -	Njakkad-Varkala
Soil S7 -	Thiruvallam

The grain size distribution of various soils was determined by wet sieve analysis and hydrometer analysis. Each soil mainly consists of silt with fine to coarse sand and clay. The soils are fertile and suitable for farming activities. The particle size distribution curves of the seven soils are shown in Fig.3.1 and 3.2 . Organic content and the physical properties were also determined. Soils were classified as per I.S classification, Textural classification and Modified Textural classification taking into consideration the practices followed by both geotechnologists and agricultural scientists.

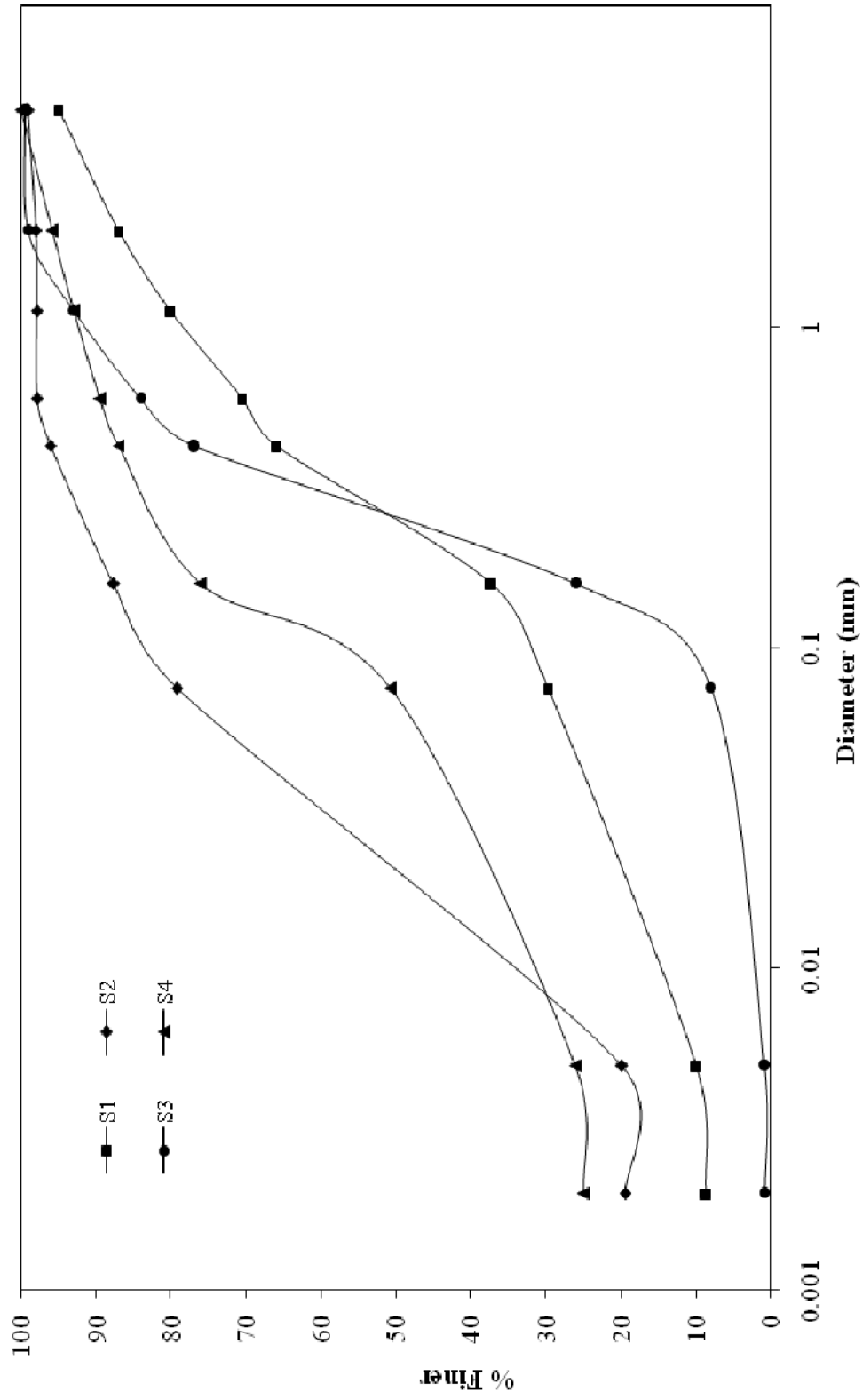
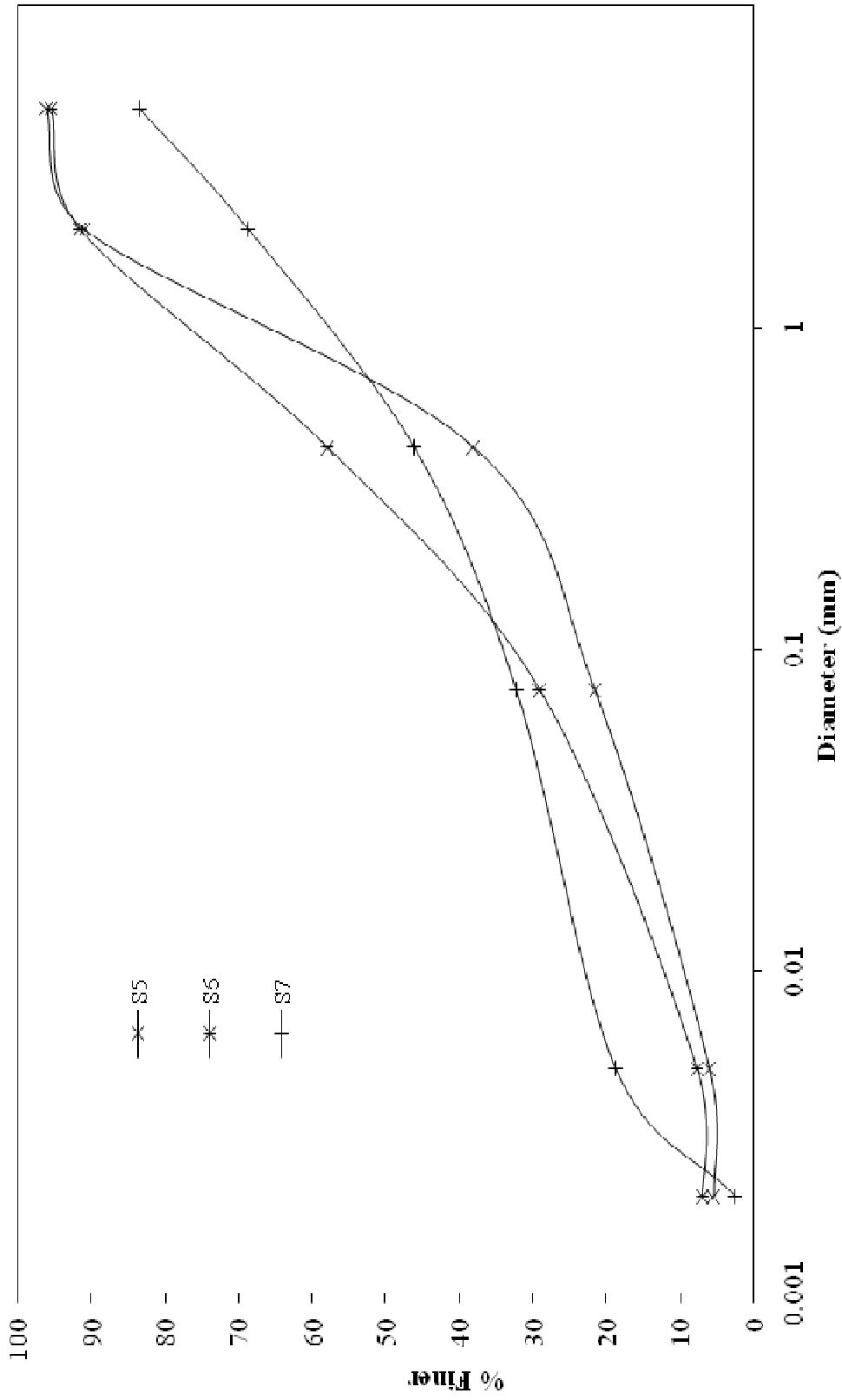


Fig. 3.1 Particle Size Distribution curve for Soils S1, S2, S3 and S4 under Study



**Fig. 3.2 Particle Size Distribution curve for Soils S5, S6 and S7 under Study**

Table 3.1 shows the grain size distribution by IS Classification followed in geotechnical engineering. However, as discussed in detail in the earlier chapter, agricultural scientists follow the Textural Classification using the triangular chart. The results from this method are also presented in Tables 3.1 & 3.2. Core sampling method was used to collect undisturbed soil samples which helped to determine the insitu density of soils. This method involves finding the weight of a known volume of soil taken in its natural state using a core sampler. Field density was determined using the core samples and the minimum and maximum densities were determined in the laboratory by packing the soil in loose state and compacting the soil by vibration. The values are presented in Table 3.3 along with other index properties. The chemical properties of the soil are pH, cation exchange capacity and nutrient contents like calcium, potassium, nitrogen, phosphorus etc. The pH value refers to the soil acidity or alkalinity and it is a measure of the H<sup>+</sup> ions in the soil. The soil's ability to absorb and exchange ions is its exchange capacity. The pH values, organic carbon, cation exchange capacity and nutrients of soil samples were also determined by standard methods and summarized in Table 3.4.

**Table 3.1 Particle Size Distribution of Soils as per IS Classification**

<b>Contents</b>	<b>S1</b>	<b>S2</b>	<b>S3</b>	<b>S4</b>	<b>S5</b>	<b>S6</b>	<b>S7</b>
Gravel (%)	5	1	0	0	4	5	11
Coarse sand (%)	8	1	1	4	5	4	15
Medium sand (%)	21	2	22	9	53	33	22
Fine sand (%)	36	17	76	35	17	29	27
Silt (%)	21	60	1	27	16	22	11
Clay (%)	9	19	0	25	5	7	14

**Table 3.2 Particle Size Distribution of Soils as per Textural Classification /  
Modified Textural Classifications**

<b>Contents</b>	<b>S1</b>	<b>S2</b>	<b>S3</b>	<b>S4</b>	<b>S5</b>	<b>S6</b>	<b>S7</b>
Sand (%)	70	28	94	52	77	73	56
Silt (%)	19	52	5	21	14	19	16
Clay (%)	11	20	1	27	9	8	28

**Table 3.3 Physical Properties of Soil**

<b>Properties</b>	<b>S1</b>	<b>S2</b>	<b>S3</b>	<b>S4</b>	<b>S5</b>	<b>S6</b>	<b>S7</b>
Specific Gravity(G)	2.58	2.35	2.58	2.50	2.54	2.49	2.57
Natural Water Content (%)	4.80	23.81	5.09	16.12	15.48	13.30	10.50
Liquid Limit	23.30	47.50	-	40.50	-	-	39.60
Plastic Limit (%)	17.22	28.92	-	18.21	-	-	23.57
Plasticity Index	6.08	18.58	-	16.29	-	-	10.93
$\gamma_d$ (max), kN/m <sup>3</sup>	17.10	12.00	16.30	15.40	16.00	15.90	15.80
$\gamma_d$ (min), kN/m <sup>3</sup>	15.20	10.40	13.70	12.70	13.90	13.50	13.00
$\gamma_d$ (field), kN/m <sup>3</sup>	15.90	11.00	14.40	13.70	14.50	14.40	14.00
Organic Matter (%)	1.9	4.1	1.2	2.9	0.3	0.4	0.7

**Table 3.4 pH Value and Nutrients of Soil Samples**

Sample	pH	OC%	Available N kg/ha	Available P Kg/ha	Available K Kg/ha	Available Ca Kg/ha	Cation exchange capacity cmol(p+ )kg <sup>-1</sup>
S1	5.09	0.30	46.38	44.38	53.76	666.18	9.66
S2	5.18	1.36	240	12.36	380.8	1101.18	24.10
S3	5.28	0.14	126	8.24	188.16	285.6	3.35
S4	5.10	0.48	70.00	131.18	239.68	568.51	16.51
S5	5.22	0.61	65.58	31.46	63.32	835.90	5.75
S6	5.43	0.59	51.24	35.41	59.12	876.45	5.80
S7	5.29	0.73	75.17	145.50	152.80	601.44	15.67

### 3.2.2 Water

Quality of water refers to its degree of suitability for a specific purpose and it largely depends on its physico-chemical composition. Quality of water for irrigation refers to the degree of suitability for crop growth and it depends on nature and amount of dissolved salts which contain relatively small but important amounts of dissolved salts originating from dissolution of weathering rocks and soil and dissolving of lime, gypsum and other salt sources, as water passes over or percolates through them.

The quality of water used in the experiment was subjected to physico chemical and bacteriological analysis. The properties of water used in the study such as pH, total dissolved solids, acidity, alkalinity etc were determined by using IS methods and summarized in Table 3.5 with a comparison to values recommended by American Public Health Association.



**Table 3.5 Quality of Water Used**

Sl. No.	Parameters that control Quality Characteristics	Parameters of Water used	Range of Parameters as per Standards
1	pH	7	6.5 to 8.5
2	Total dissolved solids	130.0 ppm	500-2000 ppm
3	Total hardness (as CaCO <sub>3</sub> )	60.0 ppm	300-600 ppm
4	Fluoride (as F)	Nil	1-1.5 ppm
5	Acidity	-	-
6	Alkalinity	70.6 ppm	200-600 ppm
7	Iron (as Fe)	0.3 ppm	0.3 – 1 ppm
8	Chloride (as Cl)	33.75 ppm	250-1000 ppm
9	Sulphates (as SO <sub>4</sub> )	Nil	200-400 ppm
10	Residual free Chlorine	Nil	0.2 ppm
11	Nitrate (as NO <sub>3</sub> )	2 ppm	45.0 ppm

### 3.2.3 Admixtures

Any material used at the surface of a soil primarily to reduce evaporation or to keep weeds down may be designated as a mulch. Examples are saw dust, manure, straw, leaves, crop residues and other litter. Mulches are highly effective in checking evaporation and are most popular for home gardens and for high-valued crops. Mulches comprised of crop residues are effective in curtailing evaporation and in turn, conserving soil moisture.

It is a well established fact that presence of organic matter increases the saturated hydraulic conductivity of soils (Lavti and Paliwal 1985) as well as soil water retention at field capacity and at wilting point (Badanur et al. 1990). The incorporation of fresh organic matter modifies the above functional properties of the soil . When incorporated into the soil, organic matter undergoes microbe-induced changes, driven by soil structural and micro-environmental factors. Coir pith, a byproduct of coir industry, coir pith compost, a manure developed from coir pith and vermi compost, the excreta of earth worm are the three admixtures selected for the present study and they are known to contain high organic carbon to aid aeration porosity. An attempt has been made here for a comparative assessment of the

efficiency of the above three admixtures in promoting water retention capabilities. The various admixtures used in this study and the reasons for selecting these admixtures are discussed below:

### **3.2.3.1 Coir Pith**

Coir Pith (CP) was collected from Kaniapuram in Trivandrum district, which is a by product of the coir industry (Fig. 3.3 a). This spongy cork like material left to itself, is normally resistant to biodegradation. Among various substitutes tried and tested by scientific investigation and research, coir based substrates were found to be a suitable alternative to peat for the formulation of substrates for production of bedding plants. There is at present a consistently growing demand for coir dust/pith as a medium to promote growth of vegetation. The coir pith is fibrous in nature and this improves the physical properties of even heavy clay soil and allows free drainage when pith is incorporated as an ameliorant or admixture. Because of its sponge like structure, coir pith helps to retain water and improve aeration.

Coir pith has a phenomenal high water holding capacity. It can hold water upto 6 times or more of its dry weight. It can hold moisture (therefore nutrients in solution) for longer periods and make it available to the plants when required. Loose structure of coir pith provides better aeration and enables better root development. It is resistant to bacteria and fungal growth, odourless and free from pathogens, weeds and toxins. Its slow decomposition reduces replacement costs. The particle size distribution curve and the chemical composition of coir pith are shown in Fig 3.4 and Table 3.6 respectively.

### **3.2.3.2 Coir Pith Compost**

Coir pith compost (CC) was collected from Agricultural College, Vellayani, Trivandrum (Fig. 3.3.b). Coir pith compost developed from coir waste is a good organic manure and soil conditioner applicable to agricultural crops. Pith plus, a spawn of edible mushroom *pleurotus sojar-caju* speeds up the decomposition process and leads to 42% reduction in volume of coir pith. Application of coir pith manure improves the physical and chemical properties of the soil. Coir pith compost has high moisture retention and it improves the physical and biological condition of soil. It improves aeration and reduces frequency of irrigation. It promotes strong and

healthy root system and is an excellent medium for plant growth. The particle size distribution curve and the chemical composition of coir pith compost are shown in Fig 3.4 and Table 3.6 respectively.

### **3.2.3.3 Vermicompost**

Vermicompost (VC) also was collected from Agricultural College, Vellayani, Trivandrum (Fig. 3.3 c). Vermicompost is dark brown / black humus like material, soft in feel and free from any foul smell, live weed seeds and other contaminations. It is the excreta of earthworm, which is rich in humus. Mucus like substance coated on each particle, increases aeration in soil, provides excellent water holding capacity and increases drainage in heavy soils. It contains sufficient moisture at the time of packing. The vermicompost promotes better root growth and nutrient absorption. The particle size distribution curve, chemical composition and water retention characteristics of vermicompost are shown in Fig 3.4 and Table 3.6 respectively.



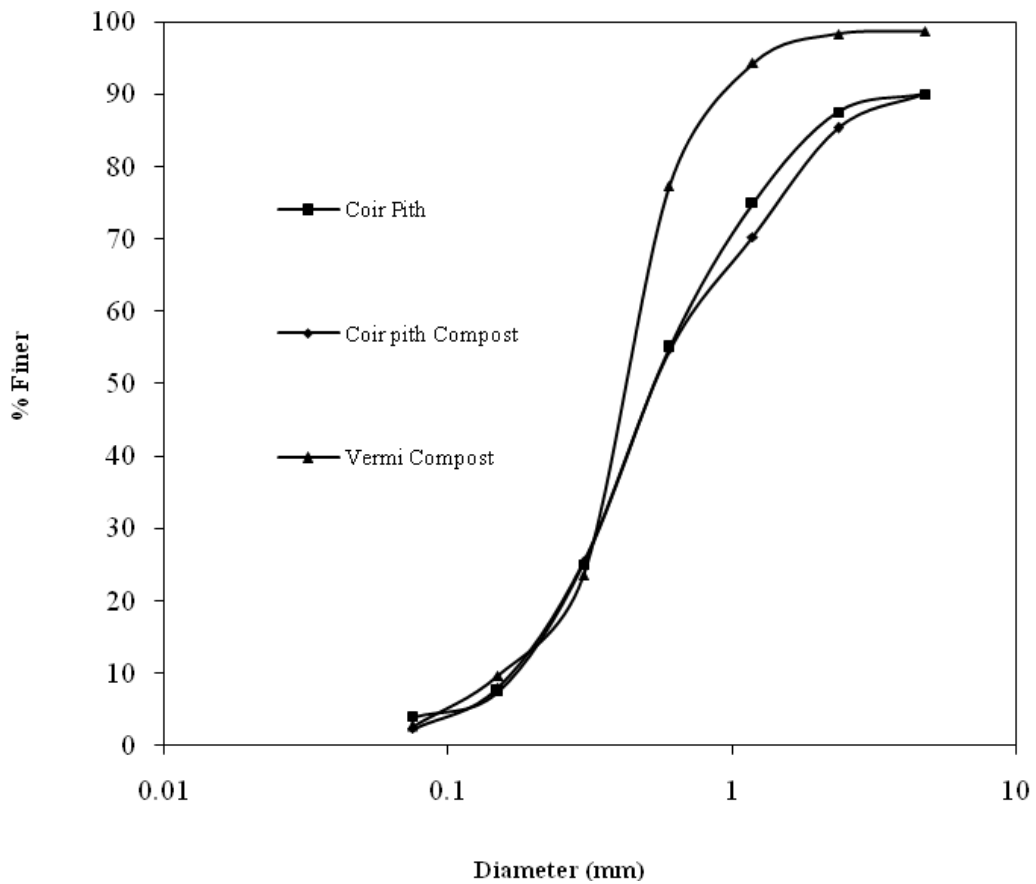
**Fig. 3.3 a. Coir Pith**



**Fig. 3.3 b. Coir pith Compost**



**Fig. 3.3 c. Vermicompost**



**Fig. 3.4 Particle Size Distribution Curve for Admixtures**

**Table 3.6 Chemical Composition of CP, CC and VC**

<b>Chemical composition</b>	<b>Coir Pith (CP)</b>	<b>Coir pith Compost (CC)</b>	<b>Vermi Compost (VC)</b>
Organic Carbon (%)	29.0	24.5	22.6
N (%)	0.26	1.06	1.0
P (%)	0.01	0.06	0.7
K (%)	0.78	1.2	1.5
Ca (%)	0.4	0.5	3.0
Mg (%)	0.36	0.48	0.4
Fe (%)	0.07	0.09	0.3
C:N ratio	112:1	24:1	14:1
Lignin (%)	30	4.8	-
Cellulose (%)	26.5	10.1	-

### **3.3 METHODS FOR DETERMINATION OF MOISTURE AND MATERIAL CHARACTERISTICS**

The present study is an attempt to evolve techniques to improve the water holding capacity of soil with a view to ensure the most efficient utilisation of irrigation water. As water becomes scarcer and scarcer, especially with the present all pervading environmental problems, irrigation efficiency has serious implications in agricultural production. This is definitely interdisciplinary in nature and any attempt to investigate the problem has to blend geotechnical and agricultural engineering practices. Experimental methods have to be evolved to determine:

1. the evaporation loss of saturated soil samples by measuring the water content continuously for 35 to 40 days keeping the samples at a room temperature of 28 – 33<sup>0</sup>C and at 33 to 39<sup>0</sup>C when kept open to sun light.
2. the field capacity of soils by saturating them and determining the water content after one or two days till the drainage is negligible
3. Field capacity, permanent wilting point and water content at different soil suction using pressure plate apparatus.
4. the saturated hydraulic conductivity by oedometer apparatus and Rawe Cell apparatus.
5. pH value, different nutrient contents and cation exchange capacity of the soils by standard procedures.
6. Parameter that control the quality of water which includes pH, total dissolved solids, total hardness, fluoride, acidity, alkalinity etc. by using IS standards.

#### **3.3.1 Evaporation Loss and Field Capacity**

Evaporation is the conversion of water from liquid to gaseous state through the absorption of heat energy. It is only due to evaporation that the moisture can reach the atmosphere from the ocean and land surface and finally result in rain fall which is the basic source of water for sustaining life. All the time evaporation is responsible for loss of water from land surface and plant surface. Evaporation is influenced by the temperature on the water / land surface and the air, relative humidity of the surrounding air and wind velocity. The temperature provides the necessary energy for vaporisation. If the relative humidity of the surrounding air is low that is it is dry then the vapour pressure difference increases which increases the

evaporation. High wind velocity also increases evaporation. Here the evaporation loss is determined by measuring the weight of the saturated soil sample every day for a specific period.

A parameter which is of paramount importance in irrigation efficiency is the field capacity of the soil. Field capacity is the amount of water remaining in the saturated soil after all gravitational water has been drained out. During a rain shower or irrigation application, the soil pores will be filled with water. If all soil pores are filled with water the soil is said to be saturated. Plants need both air and water in soil. At saturation no air is present and the soil is incapable of sustaining plant life. After the rain or irrigation has stopped, part of the water present in the larger pores will move downwards which is the process called drainage. After the drainage has stopped the larger soil pores are filled with both air and water, and smaller pores are still full of water. At this stage the soil is said to be at field capacity (FC) and at this field capacity the water and air contents of the soil are considered to be most ideal for crop growth.

Little by little the water stored in the soil is taken by plant roots or evaporation from the top soil into the atmosphere. If no additional water is applied to the soil, it gradually dries out. The drier the soil becomes, the more tightly the remaining water is retained and the more difficult it is for the plant roots to extract water. At a certain stage, the uptake of the water is not sufficient to meet the plant's needs. The plant loses freshness and wilts; the leaves change colour from green to yellow and finally the plant dies. The soil water content at this stage where the plant dies is called permanent wilting point. The amount of water actually available to the plant is the amount of water stored in the soil at field capacity minus the water that will remain in the soil at permanent wilting point. The soil still contains some water, but it is too difficult for roots to suck it from soil. This stage at which the water retained is difficult to be extracted by the plant roots to meet their needs is called the permanent wilting point (PWP).

In order to measure the above soil properties the air dried soil samples passing through 4.75 IS sieve were prepared in different relative densities in cylindrical containers perforated at bottom. Both the diameter and height of the cylinder container was 80mm. Filter paper was placed at the bottom of the cylindrical container and filled with known weight of soil samples in layers. Each layer of soil was pored into the cylinders and compacted to attain the desired density. The samples, kept in a tray which

has a constant water level 2cms deep, were allowed soak by capillary action for saturation. The saturation time for various soils were different, less time for sandy soils and maximum time for clayey soils ie 6 hours to 2 days.

After saturating the specimens, they were weighed and then transferred to a tray over which a coir mat was placed to absorb the drained water. The water in the samples was allowed to drain for 24 hours by keeping the cylindrical specimens on top of the coir felt. After 24 hours, the weight of each of the samples was noted every hour until the change in weight was negligible. The field capacity which is the water content after the gravitational water was drained out, was determined. The evaporation loss of the samples was then calculated by noting the change of the weight of the sample each day. The water content determination was then continued for 30 to 35 days till a steady state is achieved by keeping the specimens at room temperature to determine the evaporation loss. The samples were kept at room temperature or open to sunlight to simulate different field conditions. Once the samples of untreated soils were tested for field capacity and evaporation losses, there after samples were prepared with soils treated with admixtures coir pith, coir pith compost and vermi compost and tested. The admixtures were mixed with soil in two ways – random mixing or placed as a layer at a depth of 2cm from soil surface. Variation of water content with time for the two types of mixing was noted. The test specimens for determination of evaporation and field capacity are shown in Fig. 3.5.



**Fig. 3.5 Test Specimens**

The admixtures used for the study were added at 1, 3, 5 and 10% by dry weight to the soil. From the tests conducted on soils without admixture, the relative density corresponding to better field capacity and retention with time were found out. The soils with the admixtures were filled at the relative density approximately equal to that of field condition, in the cylindrical containers in the same procedure as mentioned above for S1, S2, S3, S4, S5, S6 and S7.

### **3.3.2. Field Capacity by Pressure Plate Apparatus**

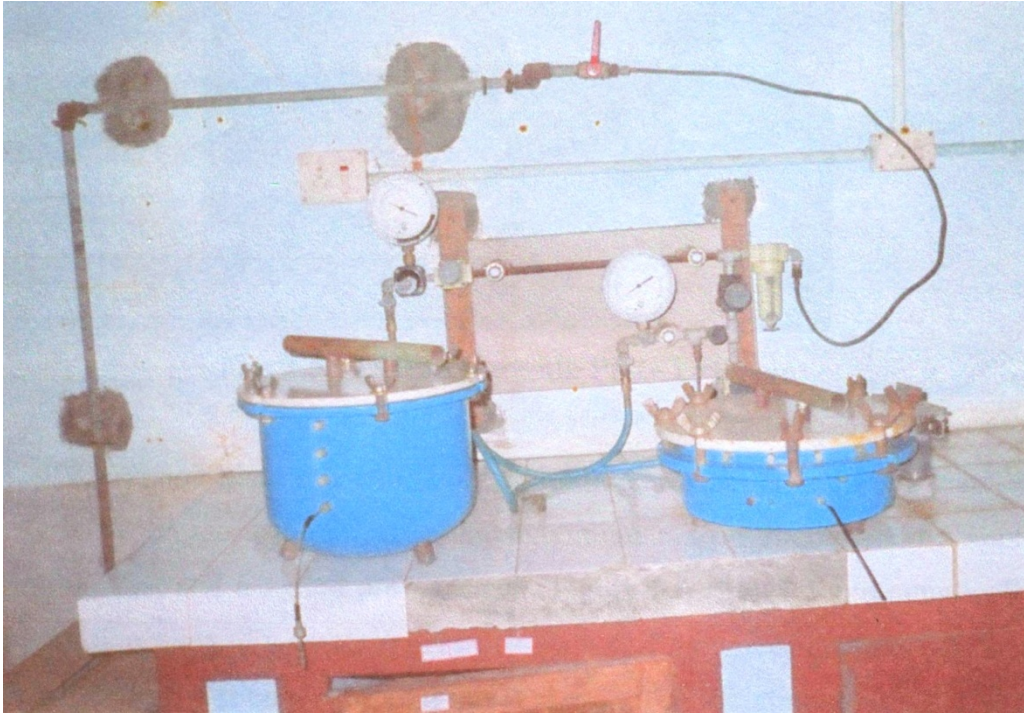
The amount of moisture retained by soils at tension between field capacity and permanent wilting point can be quantified. The amount of moisture a soil holds by metric tension by placing the water saturated soil on a porous plate and subjecting the two sides of the membrane to the desired difference in tension is the principle involved in the method. Pressure plate apparatus is commonly used to quantify the moisture retained in the soil. Pressure plate apparatus has been used as a standard technique for determination of soil water retention at an imposed matric potential since the introduction of the method by Richards and Fireman (1943) and Richards (1948). The technique involves placing a saturated soil sample on a porous ceramic plate inside a pressure chamber. The underside of the ceramic plate is maintained at atmospheric pressure while the soil samples are pressurized, thus creating a hydraulic gradient and subsequent flow of water from the samples through the saturated ceramic plate. In theory, flow ceases once the soil samples reach equilibrium with the imposed pressure.

If the water contained in the voids of a soil is subjected to no other force than gravity, the soil lying above the water table would be completely dry. However, powerful molecular and physico-chemical forces acting at the boundary between the soil particles and the water cause the water to be either (a) drawn up into otherwise empty void spaces or (b) held there without drainage following infiltration from the surface. The attraction that the soil exerts on the water is termed soil suction and manifests itself as a tensile hydraulic stress in a saturated piezometer with a porous filter placed in intimate contact with the water in the soil.



Total soil suction is defined in terms of the free energy or the relative vapour pressure (relative humidity) of the soil moisture. The total suction consists of two components: matric suction and osmotic suction. Both components are due to differences in relative humidity of the soil vapour. A meniscus forms at the soil-air interface due to the surface tension resulting in reduced vapour pressure in the water. The decrease in vapour pressure becomes more negative and the matric suction pressure increases as the radius of curvature of the meniscus decreases. The size of the soil pores decreases with decrease in soil particle size which then affects the size of the radius of curvature and consequently the matric suction pressure. The vapour pressure decreases as the degree of saturation decreases. The presence of dissolved ions in water decreases the soil vapour pressures, relative humidity, which then increases the total soil suction. Osmotic suction can form a significant portion of the total soil suction. Water flows through the membrane of the pressure plate apparatus into the solution due to the osmotic suction in the solution. Water flows through the membrane into the pure water due to the application of pressure on the solution. The pressure on the solution required in order to equalize the flow of water from the solution to the pure water is equal to the osmotic pressure of the solution.

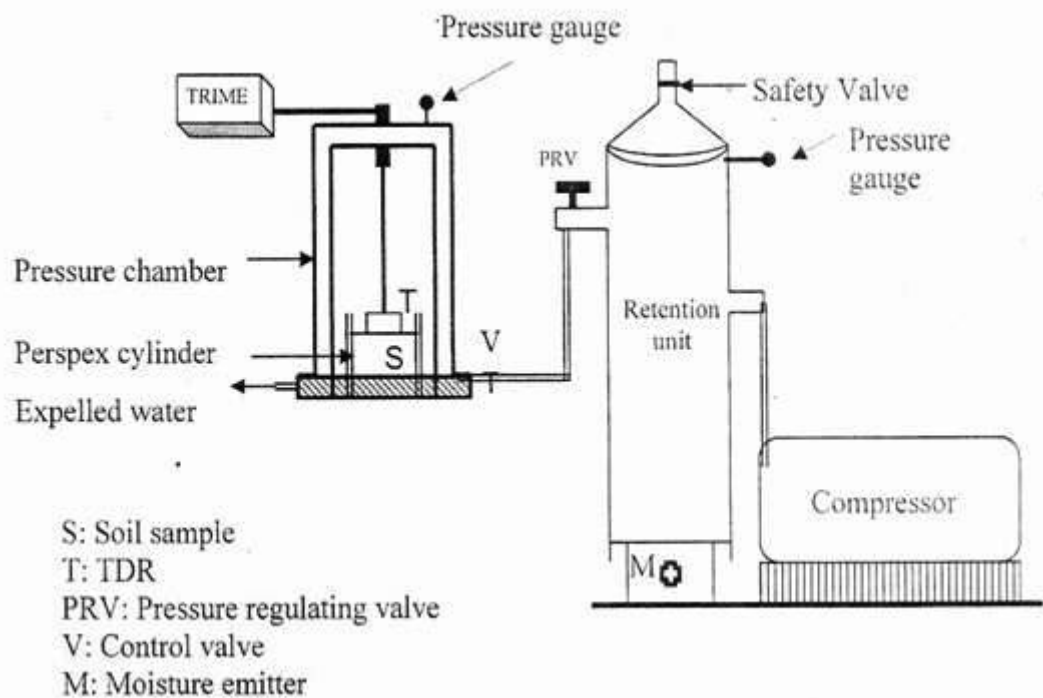
Soil water that is in equilibrium with free water is by definition at zero soil matric suction or saturation. The soil water characteristic curve (SWCC), which relates suction (matric, total, or both) to water content or saturation, is essential for characterizing the hydraulic and mechanical behaviour of unsaturated soils. The method used to measure the SWCC depends on the texture of the soil (coarse versus fine) and the magnitude of the suctions that must be established. For finer textured soils (silts, clays, and silty or clayey sands), a pressure plate extractor is normally used where lower suctions (<5 bar) are to be applied. For higher matric suctions, pressure plate extractors are used that have robust pressure cells, which can withstand higher air pressures (15bars). 5 bar pressure plate extractor and 15 bar ceramic plate extractor are shown in Fig. 3.6a and Fig. 3.6b respectively. Fig 3.7 shows the schematic of pressure plate apparatus.



**Fig.3.6a. 5 Bar Pressure Plate Extractor**



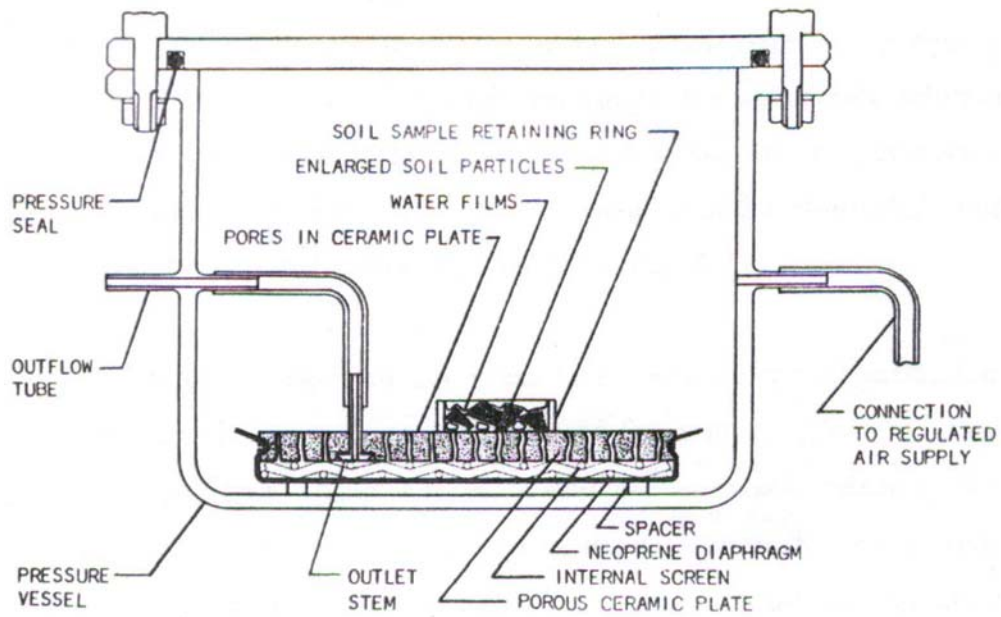
**Fig.3.6b. 15 Bar Ceramic Plate Extractor**



**Fig. 3.7 Schematic View of Pressure Plate Test Setup**

A pressure plate extractor has two main components: a porous plate with an air-entry pressure higher than the maximum matric suction to be applied during the test and a sealed pressure cell. Fig. 3.8 shows diagrammatically a cross-section view of a ceramic pressure plate cell mounted in a pressure vessel with outflow tube running through the vessel wall to the atmosphere and with the soil sample held in place on the porous ceramic surface of the cell.

Each ceramic pressure plate cell comprises of a porous ceramic plate, covered on one side by a thin neoprene diaphragm, sealed to the edges of the ceramic plate. An internal screen between the plate and diaphragm provides a passage for flow of water. An outlet stem running through the plate connects this passage to an outflow tube fitting, which connects to the atmosphere outside the extractor.



**Fig. 3.8 Cross-section view of ceramic pressure plate cell and soil sample, in Extractor**



**Fig. 3.9 Soil samples kept for saturation**

To use the ceramic pressure plate cell, one or more soil samples are placed on the porous ceramic surface, held in place by retaining rings of appropriate height. The soil samples together with the porous ceramic plate are then saturated with water. This is usually done by allowing an excess of water to stand on the surface of

the cell for several hours. After the porous ceramic plate in the pressure plate cell and the soil sample are completely saturated with water, the cell can be mounted in the pressure vessel and air pressure used to effect extraction of moisture from the soil samples under controlled conditions. The soil samples kept for saturation is shown in Fig. 3.9.

A source of regulated gas pressure is required for all extraction works. Compressed air from a compressor was used for applying the pressure. As soon as air pressure inside the chamber is raised above atmospheric pressure, the higher pressure inside the chamber forces excess water through the microscopic pores in the ceramic plate and out through the outlet stem via the passage afforded by the screen. The high pressure air, however, will not flow through the pores in the ceramic plate since the pores are filled with water and the surface tension of the water at the gas-liquid interface at each of the pores supports the pressure much the same as a flexible rubber diaphragm.

During a run, at any set air pressure in the extractor, soil moisture will flow from around each of the soil particles and out through the ceramic plate until such time as the effective curvature of the water films throughout the soil are the same as at the pores in the plate. When this occurs, equilibrium is reached and the flow of moisture ceases. The samples are then removed for water content determination. At equilibrium, there is an exact relationship between the air pressure in the extractor and the soil suction (and hence the moisture content) in the samples.

This method involves quantifying the amount of moisture retained by soils at tension between field capacity and wilting point. The amount of moisture a soil holds by matric suction by placing the water saturated soil on a porous plate and subjecting the two sides of the membrane to the desired difference in tension is the principle involved in the method. Pressure plate apparatus was used to quantify the moisture retained at 0.3, 1.0, 3.0, 5.0 & 15.0 bar tensions.

Using this method, the water retention of each soil was determined. The admixtures used for the study were added in percentages of 1, 3, 5 and 10% of the dry weight into the soil. From the laboratory tests conducted on soil as per clause 3.3.1 without admixture, the relative density giving better field capacity corresponding to  $\gamma_{d \text{ field}}$  and retention with time were found out. The soils with the admixtures were filled at that relative density in the cylindrical containers in the same procedure as mentioned above.

### **3.3.3 Hydraulic Conductivity**

The rate of movement of water within the soil differs for different types of soils and the hydraulic conductivity has influence on the water retention characteristics, ie field capacity and available water (the amount of water actually available to the plant is the amount of water stored in the soil at field capacity – the water that will remain in the soil at permanent wilting point.. The clay percentage was negatively related to the saturated hydraulic conductivity because as the clay content increases hydraulic conductivity decreases. The rate of movement of water can be determined by variable head permeameter method using Darcy's law.

The hydraulic conductivity was determined using oedometer apparatus and Rawe cell apparatus.

When the rate of flow through the soil sample is too small to be accurately measured in the constant head permeameter, the falling head apparatus is used. A coarse filter screen is placed at the upper and lower ends of the sample. The base of the sample is connected to the water reservoir; the top of the sample is connected to a glass standpipe of known cross-sectional area. This pipe is filled with water: as the water seeps down through the soil sample, observations are taken of time versus height of water in the standpipe above base reservoir level. The experimental setup is shown in Fig. 3.10.



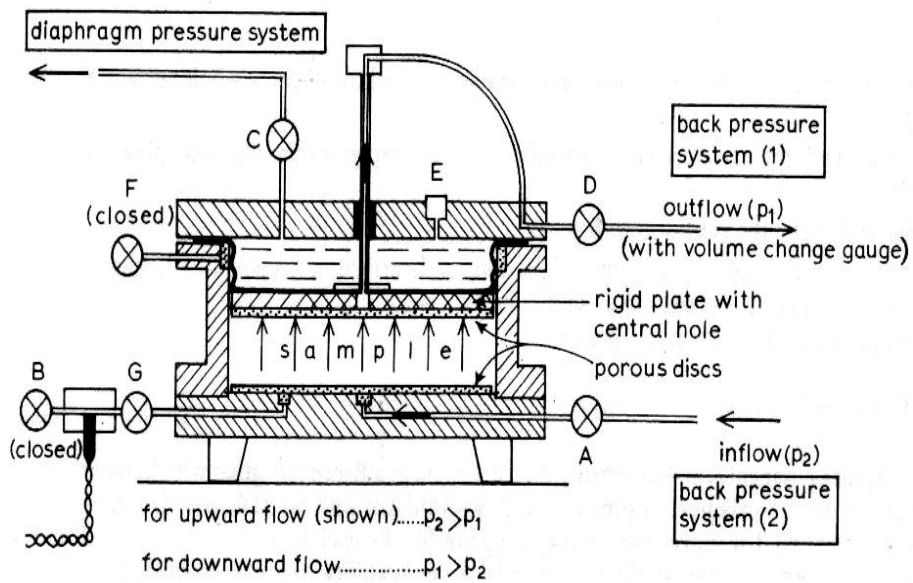
**Fig 3.10 Experimental setup for Permeability Measurement**

A series of tests were performed, using different sizes of standpipe, and the average value of the coefficient of permeability is taken. In this case the permeability is calculated by the following equation:

$$k = \frac{2.303.a.L}{A.t} \log_{10} \left( \frac{h_1}{h_2} \right)$$

Where  $a$  is the area of stand pipe and  $t$  is the time interval during which the head reduces from  $h_1$  to  $h_2$ .

Rowe's consolidation cell can be used to measure the hydraulic conductivity of soils. The experimental arrangement is showed in Fig. 3.11. In the vertical flow situation, a differential pressure between the base and the top of the sample is maintained by the inlet and the outlet pressure systems. The flow is indicated by the inlet burette and verified by the outlet burette. A manometer records the pressure difference across the sample. It is seen that a vertical pressure equal to the overburden pressure can be applied to the sample thus simulating the field stress state, and that the radial permeability of relatively large diameter samples can be measured. The photographic view of the Rowe cell is shown in Fig. 3.12.



**Fig. 3.11. Vertical Permeability using Rowe Consolidometer.**



**Fig 3.12 Experimental setup for Permeability Measurement using Rowe Cell Apparatus**

The preparation of the sample and assembly of the cell are summarised as follows:

- (1) Fit a bottom drainage disc on the cell base.
- (2) Set up the sample in the cell by the appropriate method
- (3) Fit a drainage disc and rigid steel plate on top of the sample. The hole in the plate must coincide with the settlement stem drainage outlet.
- (4) Assemble the cell top.



Three independently controlled constant pressure systems are required for the permeability test. One system is connected to valve C to provide pressure on the diaphragm. Two separate back pressure systems are used, one connected to valve D and the other to valve A. Each system may incorporate a volume change gauge, but if only one gauge is available it should be connected in the inlet line to the cell. Pore pressure readings are not required, except as a check on the B value if incremental saturation is applied before starting the test. Valve F remains closed.

The difference between the inlet and outlet pressures should be appropriate to the vertical permeability of the soil, and should be determined by trial until a reasonable rate of flow is obtained. The pressures can be adjusted to give either upward or downward flow. If the sample is fully saturated and maintenance of an elevated back pressure is not necessary, one surface of the sample may be connected to an open burette or reservoir instead of a constant pressure system, either from valve B for downward flow, or from valve D for upward flow.

When the rate of flow through the sample is small, the falling head principle can be used. The coefficient of permeability is calculated from the following equation, (K. H. Head 1986)

$$k_v = Q/60Ait \quad (\text{m/s})$$

where  $k_v$  = coefficient of permeability (m/s)

Q = measured volume of water (ml) in time t

t = time (minutes)

A = area of sample ( $\text{mm}^2$ )

i = hydraulic gradient =  $102 \times \Delta p/H$

$\Delta p$  = pressure difference (kPa) =  $p_1 - p_2$

H = height of sample (mm)

### **3.3.4. pH, Nutrients and Cation Exchange Capacity of various soils**

Air dried soil samples after powdering the lumps were used in the test. Admixtures were added in percentages 1, 3, 5 and 10% of the dry weight into the soil and mixed thoroughly. A rigid container having 30 cm height and 25cm diameter was used for the experiment. A drainage facility was also provided at the bottom to

collect the effluent water. The experimental set up is shown in Fig 3.13. A filter paper was placed at the bottom of the container and was filled with the known weight of mixed sample in the container to achieve the desired field density.



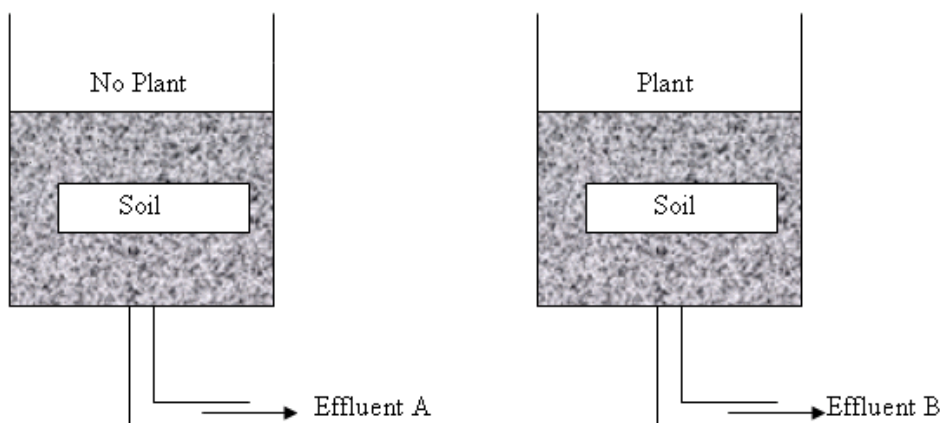
**Fig 3.13 Experimental setup**

All the prepared specimens were saturated and kept for three days. They were recharged every three days and allowed to drain. The effluent water was collected in a vessel. The same procedure was repeated for all the three types of soil with different percentages of admixtures. The specimens were kept for 60 days. The water collected at the outlet was taken for analysis to ascertain the quality of water. The soil samples were collected and tested to find the effect of admixtures on pH value, organic carbon, and nutrients such as available nitrogen, potassium, phosphorus and calcium.

The same procedure was repeated with brinjal to study the effect on planting with 5 and 10% admixtures. Experimental set up is shown in Fig 3.114. The schematic diagram is shown in Fig 3.15.



**Fig 3.14 Experimental setup**



**Fig. 3.15 Schematic Diagram**

### Soil pH

pH is the negative algorithm, to the base ten, of hydrogen ion concentration expressed in  $\text{mol L}^{-1}$ . It is determined using Glass electrode pH meter.

### Organic Carbon

Organic carbon in soil samples were analyzed using Walkley – Black method. The principle used is organic carbon in soil samples is oxidized to  $\text{CO}_2$  by an oxidizing agent, chromic acid (potassium dichromate + sulfuric acid) and the amount of dichromate remaining is determined by titration with a standard ferrous solution. Heat of dilution of  $\text{H}_2\text{SO}_4$  is used to provide the required temperature. Addition of O-phosphoric acid is essential when diphenyl amine indicators are used to ensure correct end point

### Calculation

$$\text{Organic carbon (\%)} = \frac{(\text{BV} - \text{TV}) \times \text{M} \times 0.003 \times 100}{\text{W}}$$

Where

BV	=	blank value, ml
TV	=	titre value, m
M	=	molarity ferrous solution
w	=	weight of soil (g)

Actual Organic carbon (%) = estimated organic carbon x 1.3

### **Available Nitrogen**

Micro diffusion method was used to analyze the available nitrogen content of the soil samples. The amount of soil nitrogen released as ammonia by alkaline permanganate solution, is estimated by distillation and the distillate is collected in boric acid – indicator solution and the ammonia liberated is determined by titration against standard H<sub>2</sub>SO<sub>4</sub>.

### **Calculation**

$$\text{Available N (\%)} = \frac{V_1 N_1 \times 0.014 \times 100}{w}$$

where

V <sub>1</sub>	=	Volume of N1 normal acid (titre value – blank value)
N <sub>1</sub>	=	Normality of H <sub>2</sub> SO <sub>4</sub>
w	=	weight of soil (g)

### **Available Phosphorus**

Bray and Kurtz method was used to analyze the available Phosphorus content of the soil samples. The dilute acid- fluoride extractant removes easily acid soluble phosphorus from phosphates bound to Al, Fe and Ca. Phosphate in the extract is determined colorimetrically.

The apparatus used are Reciprocating shaker, Photoelectric colorimeter or Spectro photo meter.

### Calculation

$$\text{Available P} = \frac{R \times 50 \times 50}{5 \times 5} \text{ (ppm)}$$

where

$$R = \text{P in aliquot in ppm obtained from standard curve}$$

### Available Potassium

In a weighed sample of soil, the exchangeable cations are displaced by  $\text{NH}_4^+$  ions by leaching the soil with neutral 1N ammonium acetate solution and the exchangeable K is determined using a Flame photometer.

### Calculation

$$\text{Available K (ppm)} = \frac{R \times 50 \times 50}{5 \times 5}$$

where

$$R = \text{ppm of K in the extract.}$$

Same principle was used to determine the Available calcium content of the soil sample using Flame photometer and Atomic absorption spectrophotometer.

### Cation Exchange Capacity (CEC)

Cation Exchange Capacity (CEC) is analyzed using Ammonium acetate method. In a weighed sample of soil, the exchangeable cations are displaced by  $\text{NH}_4^+$  by leaching the soil with neutral 1N ammonium acetate solution. The excess of ammonium acetate is removed with alcohol. Absorbed ammonium ( $\text{NH}_4^+$ ) is estimated by distillation and the distillate is collected in boric acid – mixed indicator solution and the ammonia liberated is determined by titration against standard acid.

The apparatus used are Kjeidahl distillation apparatus and Buchner funnel filtration assembly

### Calculation

$$\text{CEC (cmol (p+)kg}^{-1}\text{)} = \frac{\text{Volume of acid (ml)} \times \text{Normality of acid} \times 100}{\text{g of sample}}$$

where

$$\text{CEC of clay (cmol}_c\text{ kg}^{-1}\text{ clay)} = \frac{\text{CEC (soil)} \times 100}{\text{clay (\%)}}$$

### 3.3.5 Quality of Water

#### Total Hardness

A sample of 20ml was diluted in Erlenmeyer flask to 40ml by adding 20ml distilled water. 1ml of ammonia buffer solution was added so as to bring the pH to  $10 \pm 0.1$ . One or two drops of Erio chrome Black T indicator solution was added and the solution turned wine red. EDTA titrant was added with vigorous shaking till the wine red colour just turns blue. The volume of titrant added was noted as  $V_1$ .

$$\text{Hardness as CaCO}_3 = V_1 \times S \times 1000 / V$$

where  $V_1$  = ml of titrant used for sample

$S$  = mg of  $\text{CaCO}_3$  equivalent to 1ml of EDTA titrant.

1ml of EDTA = 1 mg of  $\text{CaCO}_3$ , hence  $S=1$ .

#### Acidity

A sample of 20ml was pipetted to the flask. 1 or 2 drops of methyl orange indicator was added to the sample and then the sample was titrated against 0.02N standard NaOH. The end point was noted as colour changes from orange red to yellow. The titrate value was recorded as  $V_1$ . The sample was added with one or two drops of phenolphthalein indicator and the titration was continued until colour changes to pink. The volume of titrant used was noted as  $V_2$ .

$$\text{Mineral acidity as mg/l of CaCO}_3 = V_1 \times N \times 50 \times 1000 / \text{Volume of sample} \\ (V_2)$$

#### Alkalinity

A sample of 20ml was pipetted to in to a clean Erlenmeyer flask ( $V$ ). Two drops of phenolphthalein indicator was added to the sample. This sample was titrated against standard acid, 0.02N  $\text{H}_2\text{SO}_4$  in the burette till the colour was just disappeared. The volume of titrant used was noted as  $V_1$ . Then two drops of methyl orange indicator was added and the colour was turned yellow. This is again titrated against the acid in the burette, till the yellow colour was just turned orange yellow. The volume of titrant used was noted as  $V_2$ .

$$\text{Phenolphthalein alkalinity as mg/l equivalent of CaCO}_3 = V_1 \times N \times 50,000/V$$

$$\text{Total alkalinity as mg/l equivalent of CaCO}_3 = V_2 \times N \times 50,000/V$$

Where  $N$  is the Normality of acid used.

## Iron

Iron is usually present in natural water and is not objectionable if present up to 0.3 ppm. It may be in true solution, in a colloidal state that may be peptized by organic matter, in inorganic or organic iron complexes, or in relatively coarse suspended particles. It may be ferrous or ferric, suspended or dissolved. Iron exists in soils and minerals mainly as insoluble ferric oxide and iron sulphide. It occurs in some areas, also as ferrous carbonate which is very slightly soluble. The spectrophotometer method is the standard procedure for the measurement of iron in water except when phosphate or heavy metal interferences are present.

$$\text{Iron (Fe) in mg} = \frac{\text{Optical density of unknown} \times (\text{Conc. of standard})}{\text{Optical density of standard}}$$

## Chlorides

20ml of sample was taken and diluted to 40ml (V). Since the sample was highly coloured, 3ml of aluminium hydroxide was added and shaken well. It was allowed for settling, filtering wash and collecting filtrate. Sample was brought to pH 7 – 8 by acid or alkali. 1ml of potassium chromate indicator solution was added and it is titrated against standard silver nitrate solution until a pinkish yellow colour was obtained. The volume was noted as V<sub>1</sub>. The procedure was repeated for blank and the volume was noted as V<sub>2</sub>.

$$\text{Chloride} = \frac{(V_1 - V_2) \times N \times 35.46 \times 1000}{V}$$

## Total Dissolved Solids

Total solids is the term applied to the material left in the vessel after evaporation of a sample of water/waste water and its subsequent drying in an oven at 103 – 105<sup>0</sup>C temperature. Total solids include total suspended solids, the portion of total solids retained by a filter and total dissolved solids, the portion that passes through the filter.

$$\text{Total dissolved solids, mg/l} = \frac{\text{mg of total dissolved solids} \times 1000}{\text{Ml of sample}}$$

## **Nitrate**

Nitrate reacts with phenol disulphonic acid and produces a nitro-derivative which in alkaline medium develops a yellow colour. The colour produced follows the Beer's law and is directly proportional to the concentration of nitrate present in the sample.

Plant growth can be sustained only if adequate supply of water and nutrients are ensured throughout its life. The quality of water that is used for irrigation is relevant as contaminated water may affect the fertility of farm land . Whether the admixtures used for improvement of water retention capacity affect the soil and water in any manner also has to be verified. Thus chemical analysis of all the ingredients of a farm soil is very relevant and this has been done in detail in this work , adopting the procedures described above.



---

## **STUDIES ON RETENTION CAPABILITY OF UNTREATED SOILS**

---

### **4.1 INTRODUCTION**

Soil is comprised of minerals, soil organic matter, water and air. The composition and proportion of these components greatly influence the physical properties of soil including its texture, structure, and porosity, which is the fraction of pore space in a soil. In turn, these properties influence the movement of air and water in the soil, and thus help the soil to function better to aid plant growth.

#### **4.1.1 Soil Texture and Porosity**

Soil texture has profound effect on water retention and is considered the most important among the physical properties. The term texture is used to express the percentage of the three constituents of soils, viz, sand, silt and clay. These particles are distinguished mainly by size, and make up the mineral fraction. Particles over 2mm in diameter are not considered in texture, though in certain cases, they may affect water retention and other properties. The relevant amount of various particle sizes in a soil defines its texture, i.e., whether it is a clay, loam, sandy loam or some other textural category.

Porosity is the ratio of the volume of voids to the total volume of the soil which can be calculated from the relative density of the soil. Relative density is the ratio of the difference between the void ratio of a cohesionless soil in the loosest state and any given void ratio, to the difference between its void ratios in the loosest and densest states. Unlike texture, porosity and structure are not constant and can be altered by management, water and chemical processes. Long term cultivation tends to lower total porosity because of a decrease in organic matter. Surface crusting and compaction decrease the porosity and inhibit water entry into the soil, possibly increasing surface run off and erosion. Calcareous and salt affected soils can also

alter porosity and structure. In general, increasing organic matter levels, reducing the extent of soil disturbance, and minimizing compaction and erosion will increase soil porosity and improve its structure.

Due to the geometry of the pore spaces between the soil particles and the nature of the surface, soil has the capacity to hold the water. This property enables the soil to retain precipitation or irrigation water in the root zone in the form of a reservoir of water to be used by plants over time. The amount of water held depends upon the porosity and pore size distribution and the capillary pressure of water in the soil. This relationship between the amount of water held by the soil (soil water content expressed on weight or volume basis) and the force by which it is held (capillary pressure or suction or tension referred to as soil matric potential/tension expressed in bars or kPa/MPa) is depicted in the form of a curve commonly referred to as the soil water characteristics or soil moisture release curve or soil moisture retention curve or simply the pF curve. Some typical soil water release curves were shown in chapter 2. Two regions of this curve are of particular interest to agriculturists and irrigation engineers i.e. the field capacity and the permanent wilting point as they represent the upper and lower limit of water availability to the plants.

#### **4.1.2. Field Capacity and Permanent Wilting Point**

Field capacity (FC) is the term used to describe the maximum amount of water that an initially saturated soil will retain after the gravitational water has drained out. It does not generally correspond to a fixed soil water suction (or water potential) which varies from 1/10 bar (10 kPa) for coarse textured soils to 1/3 bar (33 kPa) for fine textured soils. Since FC values are dependent on the structure, they are best estimated in the field. Even undisturbed cores are not truly representative of the field values.

Permanent wilting point (PWP) is the soil water content at or below which plants will wilt and all growth processes will cease. It is assumed to correspond to 15 bar soil water tension or suction. In the absence of equipment necessary to determine this, the permanent wilting point is determined by growing sunflower or some other

indicator plants that have an extensive rooting system and show clear wilting symptoms.

### **4.1.3 Factors Affecting water Holding Capacity of Soils**

The retention and movement of water in soils, its uptake and translocation in plants, and its loss to the atmosphere are all energy related phenomena. Vapour losses of water from the soils occur by evaporation at the soil surface and by transpiration from the leaf surface. The combined loss resulting from these two processes, termed evapotranspiration is responsible for most of the water removal from the soil during a crop growing period. A number of factors determine the relative losses from the soil surface and from transpiration:

- (a) plant cover in relation to the soil surface,
- (b) efficiency of water use by different plants;
- (c) proportion of time the crop is on the land and
- (d) climatic conditions.

Loss by evaporation from the soil is generally proportionately higher in drier regions than in humid areas. Such vapour loss is at least 60% of the total rainfall for dryland areas and losses by transpiration for about 35%, leaving about 5% for runoff.

Hydraulic conductivity and cation exchange capacity also have effect on the water holding capacity of the soils. The flow of water under saturated condition is determined by two major factors, the hydraulic force driving the water through the soil and the hydraulic conductivity, or the ease with which soil pores permit water movement. Cation exchange capacity depends on the capacity of the soil to hold positively charged cations. The larger the number of the Cation exchange capacity the more nutrients and water the soil can hold.

## **4.2 TEXTURAL CLASSIFICATION OF SOILS**

Texture is the result of weathering, the physical and chemical breakdown of rocks and minerals. Because of differences in composition and structure, materials will weather at different rates, affecting a soil's texture. The textural classification of soil incorporates only particle size. According to the triangular classification system followed by the agricultural scientists and modified triangular classification system

(developed by The Mississippi River Commission, USA) used by geotechnologists, the soils used in the study were classified as shown in Table 4.1 by conducting wet sieve analysis and hydrometer analysis.

According to both classification systems, the percentages of sand (size 0.05 to 2.0mm), silt (size 0.002 to 0.05mm) and clay (size less than 0.002mm) are plotted along the three sides of an equilateral triangle. The equilateral triangle is divided into 10 zones; each zone indicates a particular type of soil.

**Table 4.1 Textural Classification of Soils**

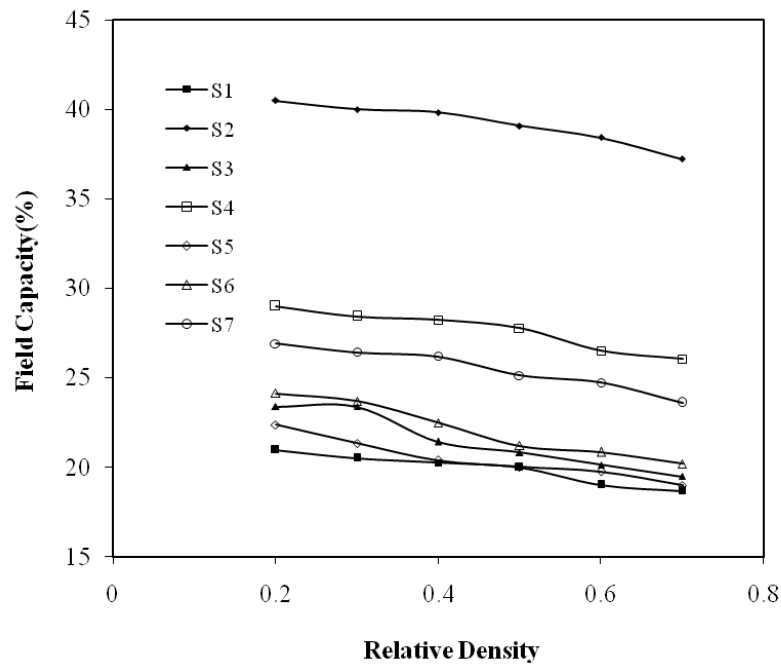
Type of Soil	Grain Size Distribution			Textural Classification (Used by Agricultural Scientists)	Modified Triangular Classification (Used by Agricultural Engineers)
	Sand	Silt (%)	Clay (%)		
S1	70	19	11	Sandy Loam	Silty Sand
S2	28	52	20	Silty Clay Loam	Sandy Silt
S3	94	5	1	Sand	Sand
S4	52	21	27	Sandy Clay Loam	Clayey Sand
S5	77	14	9	Sandy Loam	Silty Sand
S6	73	19	8	Sandy Loam	Silty Sand
S7	56	16	28	Sandy Clay Loam	Clayey Sand

From table 4.1, where all the seven soils are classified, the soils fall into four categories – sandy loam (soils S1, S5 and S6), silty clay loam (S2) S and (S3) and sandy clay loam (soils S4 and S7). Wherever detailed investigations were taken up, one from each category was chosen – soil S1 from sandy loam, soil S2 from silty clay loam, and S3 for sand and S4 from sandy clay loam.

In order to determine the effect of porosity / relative density on water holding capacity laboratory experiments were carried out on all the seven soils as described below.

All the soil samples were prepared in different relative densities of 0.2, 0.3, 0.4, 0.5, 0.6 and 0.7 in the cylindrical containers as discussed earlier in article 3.3.1. All the samples were allowed to get saturated initially and get drained till the gravitational drainage was negligible as indicated by the weight of the sample and the water content of sample was measured. This water content was a measure of the field capacity of the

corresponding soil samples. A graph is plotted between relative density (0.2, 0.3, 0.4, 0.5, 0.6 and 0.7) and this water content (field capacity) in Fig. 4.1.



**Fig. 4.1 Variation of Field Capacity with Relative Density**

It can be seen from the figure that the field capacity does not vary much with variation in relative density. For all the seven soils the variation in field capacity is just around 3% even for a significant change in relative density from 0.2 to 0.7 (which is 350%) which indicates that bulk density of soil has little influence in water retention capability of soil. In almost all the soils the fall is marginal for relative densities of 0.2 to 0.4 and higher from 0.4 to 0.7. The loosest state 0.2 gives the highest field capacity but it may not be maintainable in field. The normal relative density in field which is available or maintainable for all the soils, with wide variation in soil texture, is around 0.4 which was selected for further investigations.

In comparison to the change in relative density, the field capacity is more sensitive to the percentages of fines. Soil S2 with a fines content of 72% has a field capacity of 40.97%, which is followed by S4 and S7 which have fines contents of 48% and 44% and field capacities of 29.85% and 24.9% respectively.

The porosity corresponding to each relative density was determined for all the samples and are tabulated together with the corresponding field capacity values in Table 4.2.

**Table 4.2 Relation between Relative Density, Porosity and Field capacity**

R.D (%)	S1		S2		S3		S4		S5		S6		S7	
	n	F.C (%)	n	F.C (%)	n	F.C (%)	n	F.C (%)	n	F.C (%)	n	F.C (%)	n	F.C (%)
0.2	0.4	20.95	0.55	40.97	0.45	22.11	0.47	29.85	0.44	21.01	0.44	23.69	0.48	24.90
0.3	0.39	20.50	0.54	40.00	0.44	21.51	0.46	28.42	0.43	20.45	0.43	22.50	0.47	23.35
0.4	0.38	20.30	0.53	39.91	0.43	20.82	0.45	28.40	0.42	20.01	0.42	20.30	0.46	22.90
0.5	0.38	19.98	0.53	39.10	0.42	20.13	0.44	27.78	0.41	19.76	0.41	20.85	0.44	22.54
0.6	0.37	19.00	0.52	38.43	0.41	19.68	0.43	26.52	0.41	18.99	0.4	20.20	0.43	21.92
0.7	0.36	18.66	0.51	37.23	0.4	19.11	0.42	26.05	0.4	17.98	0.39	19.90	0.42	21.40

Note: R.D = Relative Density, n = Porosity, F.C = Field Capacity

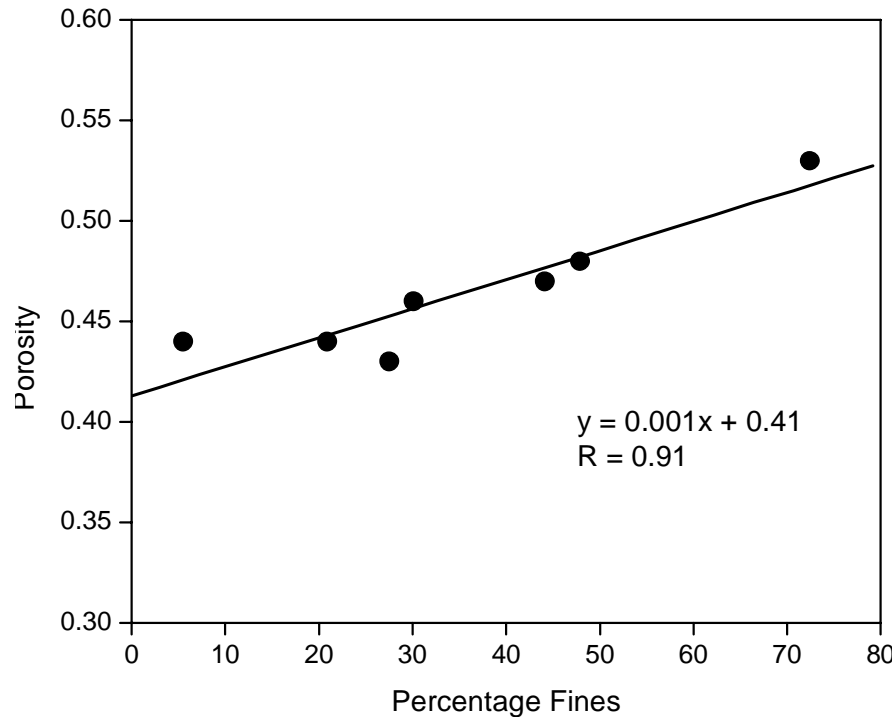
As the porosity increases, field capacity also increases and it was seen that the porosity has not much effect on field capacity. Also, only for silty clay loam field capacity was found to be high at a higher porosity.

Table 4.3 shows the in situ dry density of all the seven soils and the chosen dry density values obtained for relative density test. It can be seen from the table that five of the in situ dry densities are chosen to the values corresponding to R.D = 0.4 and the remaining two are for R.D = 0.3. This clearly shows that the normal relative density for a farm soil will be around 0.4. This value can be taken when soil specimens are prepared for various tests.

**Table 4.3 In situ and Dry Unit Weights of Different Soils**

Soils	S1	S2	S3	S4	S5	S6	S7
$\gamma_d$ in- situ (kN/m <sup>3</sup> )	15.90	11.00	14.40	13.70	14.50	14.40	14.00
$\gamma_d$ from tests (kN/m <sup>3</sup> )	15.90	11.00	14.40	13.40	14.30	13.30	14.40
<b>R.D</b>	0.4	0.4	0.3	0.4	0.3	0.4	0.4
<b>Porosity</b>	0.40	0.53	0.44	0.45	0.44	0.42	0.47
<b>% Fines</b>	30	72	6	48	23	27	44

Fig. 4.2 shows the relation between insitu porosity with percentage of fines of soil. It can be seen that there is only a marginal increase in porosity with the increase of percentage of fines i.e. silt and clay.



**Fig. 4.2 Relation between in situ porosity and percentage of fines**

A relation between insitu porosity and fines content has been obtained from the results presented in Fig. 4.2 as:

$$n = 0.001 F + 0.41 \text{ with a correlation co-efficient } R = 0.91$$

where  $n$  is the insitu porosity and  $F$  is the percentage of fines

### **4.3. EVAPORATION LOSSES AND WATER HOLDING CAPACITY**

More than half of the precipitation in dry land areas is usually returned to the atmosphere by evaporation directly from the soil surface. Evaporation losses are also high in arid regions irrigated agriculture. Even in humid region rained areas evaporation losses are of significance in hot rainless periods. Such losses rob the plants of much of their crop production potential.

#### **4.3.1 Factors affecting evaporation losses**

Solar radiant energy provides the calories (540) necessary to evaporate each gram of water whether it is from the soil (E) or from the leaf surface (T). On a cloudy day the solar radiations striking the soil and plant surface are reduced and evaporation potential is not as great.



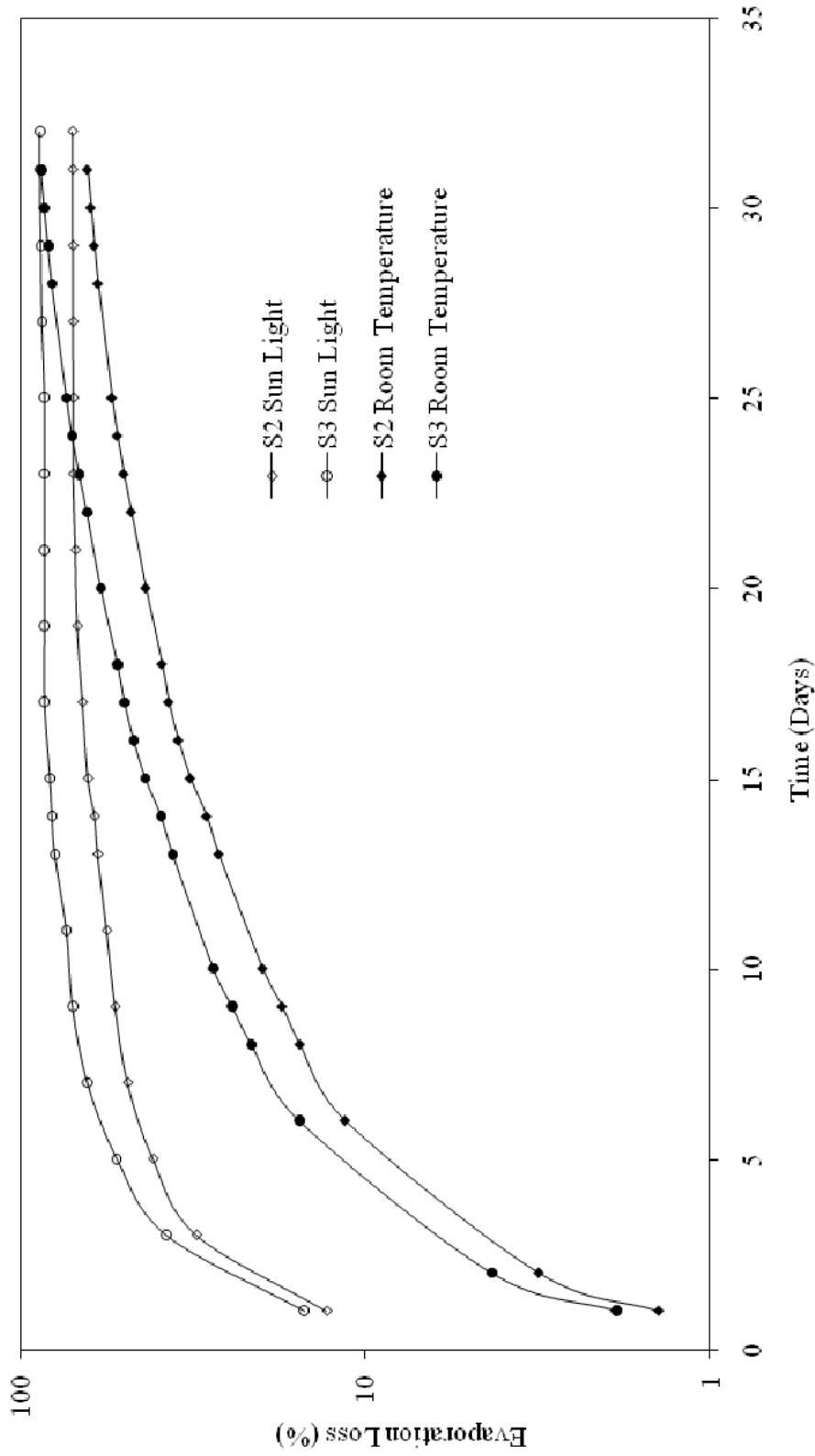
Evaporation occurs when the atmospheric vapour pressure is low compared to the vapour pressure at plant and soil surfaces. Evaporation is high from irrigated soils in arid climates and much lower in humid regions at comparable temperatures. A rise in temperature increases the vapour pressure at the leaf and soil surfaces but has much less effect on vapour pressure of the atmosphere. As a result on hot days, there is sharp difference in vapour pressure between soil surface and the atmosphere, and evaporation proceeds rapidly. This temperature difference definitely enhances the rate of evaporation. A dry wind will continually sweep away moisture vapour from a wet surface and hence intensify evaporation from soils.

Laboratory experiments were conducted, as per the methods described in chapter three, during a period January – May to study the drying process operating in agricultural soils of different textures collected from Trivandrum District. This period was selected for investigation as Kerala has dry spell from January to May while the remaining months comprises of the two monsoons. During that period, the temperature varies from 28 to 33<sup>0</sup>C inside the room and 33 to 39<sup>0</sup>C out side.

#### **4.3.2. Investigations on Evaporation Losses**

Studies on evaporation losses from the soil were carried out on all samples which were allowed to get saturated initially and get drained later till the water content reaches field capacity. The weights of the samples were to determined every day for a period of 4 to 5 weeks from which the water content and evaporation losses could be calculated for all the seven soils . Loss of water content from soil with plant life takes place due to two reasons, mainly water absorbed by plant life and water lost due to evaporation. In order to study the loss due to the latter, samples saturated were exposed to room temperature and to direct sun light and the evaporation loss was determined from the weight of the samples taken on each day.

Out of the seven soils, soil S2, collected from Chuzhattukota Trivandrum has the main content of fines ( Silt and clay) which is 72% and soil S3, collected from Kizhavor Trivandrum has the least content of fines viz 6% which is a sandy soil are selected. The relation between evaporation loss and time, for these two soils are shown in figure 4.3 when the soils are exposed to direct sunlight and room temperature. Though the trend in evaporation is same for both soils, for soil S3, the evaporation is rapid and for soil S2, it is comparatively slow which can be attributed to the fine texture of the soils. Soil S3 (sand) has a coarse texture so that it is difficult to prevent evaporation.



**Fig 4.3 Variation of Evaporation Loss with Time for S2 and S3 Kept at Sun Light and Room Temperature**

From that curve, we can note three stages in evaporation. First phase, at higher water content, the evaporation is fast and the slope of the curve is steep at that phase. In the second phase, evaporation is comparatively slower and the slope of the curve is less steep and in the third phase, the rate of evaporation is very low and the curve is almost flat. When the evaporation is carried out on sun light, the third phase is reached approximately after 15 days and at room temperature, it takes 30 days. There are techniques by which direct sun light could be almost totally controlled or even avoided to bring down the evaporation losses.

The texture of the soil especially the fines content influences the water retention capacity of the soil considerably. Soil S2 with 72% fines retains more water than soil S3 with 6% fines. However the rate of evaporation loss is more or less same in either case whether the soil is exposed to direct sunlight or not, as indicated by the two pairs of curves which seen parallel to each other in Fig 4.3.

#### **4.3.3. Control of Evaporation losses**

Any material used at the surface of a soil primarily to reduce evaporation or to keep weeds down is designated as mulch. Examples are sawdust, manure, straw, leaves, crop residue etc. Mulches are highly effective in checking evaporation and are most practical for home garden use and for high valued crops. Intensive gardening justifies the use of these moisture saving materials. Mulches composed of crop residue are effective in reducing evaporation and in turn in conserving soil moisture.

Spreading plastic sheets on the soil surface around the trees or crops or incorporating stubbles or treated coir - pith in the soil will act as a mulch on the surface to reduce the evaporation losses. Mulching protects soil against beating action of rain drops. It also facilitates rain water absorption by soil. Surface mulching immediately after sowing is an effective means of controlling runoff and soil loss on cultivated sloping land. In order to minimize evaporations from soil surface, dry soil mulch is created simply by stirring the soil with the interculturing implements.

Specially prepared paper and plastics are also used as mulches. This cover is spread and fastened down either between the rows or over the rows. The plants in

the latter case grow through suitable slits or other openings. Paper and plastic mulches can be used only with crops planted in rows or in hills as long as the ground is covered, evaporation and weeds are checked and in some cases remarkable crop increase has been reported.

Direct evaporations from soil is often a major loss of available water as it does not contribute to biomass production. Reducing evaporation can help conserve soil moisture, save irrigation water and reduce salt accumulation in surface layer of soil. Even small reduction in evaporation loss can be of great value in critical situation like germination of seed under dry conditions. Application of mulches is known to be effective in reducing soil evaporations. It was reported that organic mulch and tree shelter treatments increased the survival of plants. Mulching has also been reported to be effective reducing leaching of nitrate fertilizer and thus reduce solution.

From Fig. 4.3, it can be seen that at the evaporation of the soils kept at room temperature is significantly less compared to that at sun light. This represents the effect of mulching/shading, i.e. evaporation loss can be significantly reduced by mulching /shading.

Graphs were plotted for evaporation loss for all the seven soils as shown in Fig. 4.4. Lowest cumulative evaporation was observed in silty clay loam, which had high water holding capacity, followed by sandy clay loam, sandy loam and sand. The most effective practices aimed at controlling evaporations are those that provide some cover to the soil. This cover can be provided by mulches and by selected conservation tillage practices and in some cases by green house farming.

From the graph plotted between evaporation loss and time for soils in Fig. 4.4. The time for 25 and 50% evaporation loss is determined for the samples kept at room temperature and exposed to sun light.

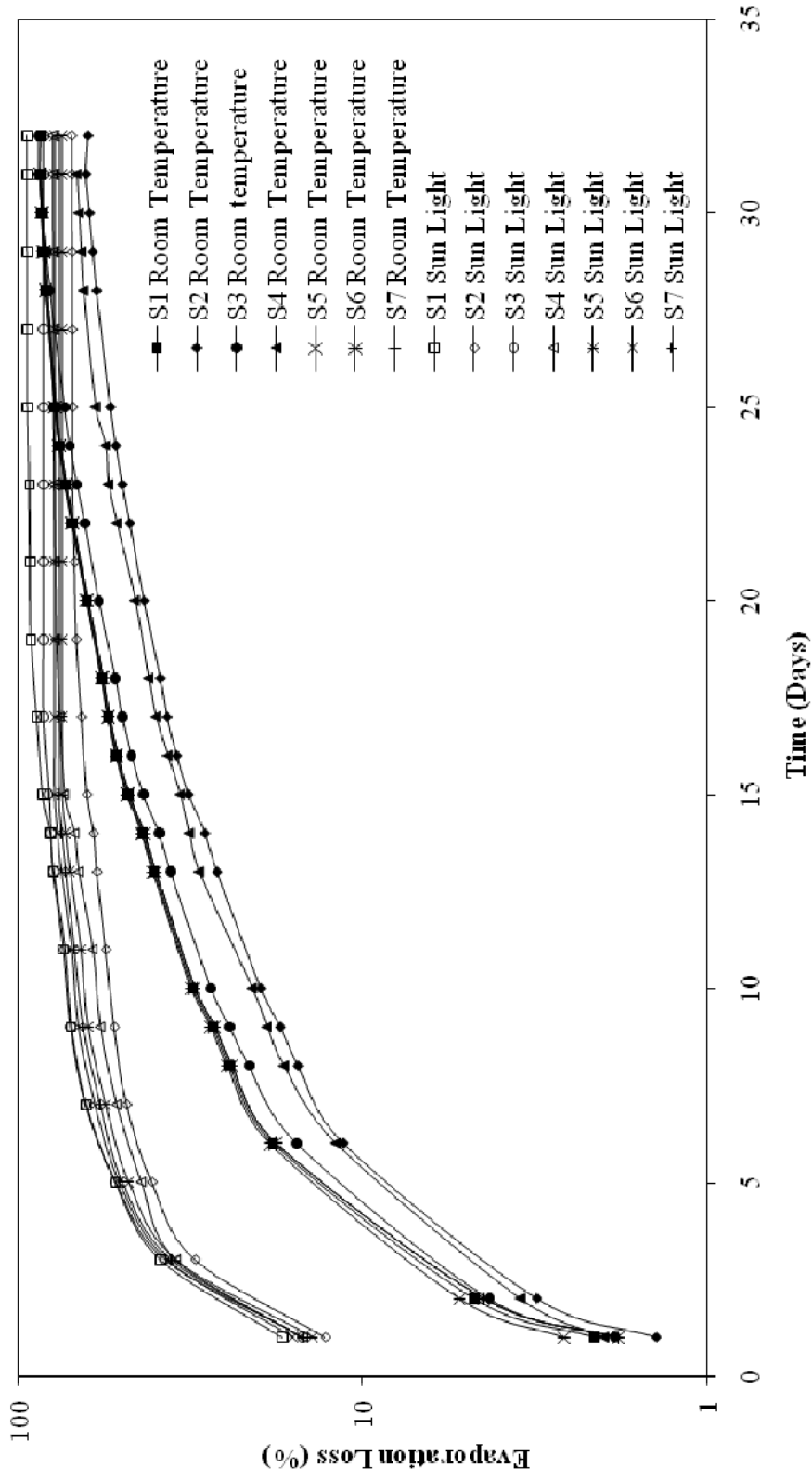
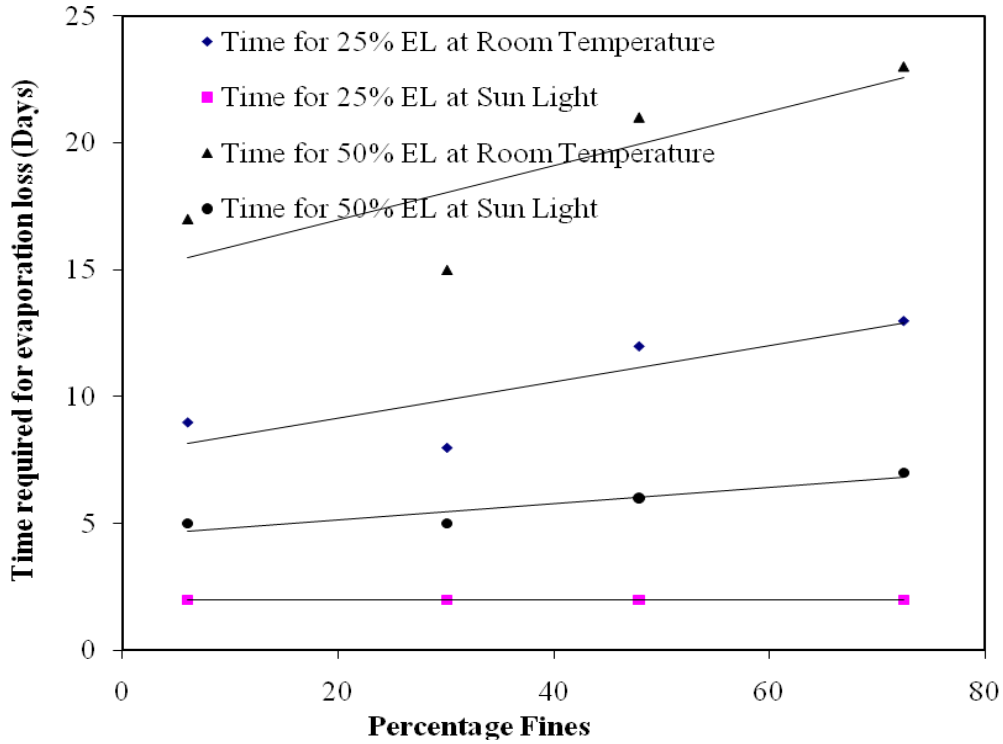


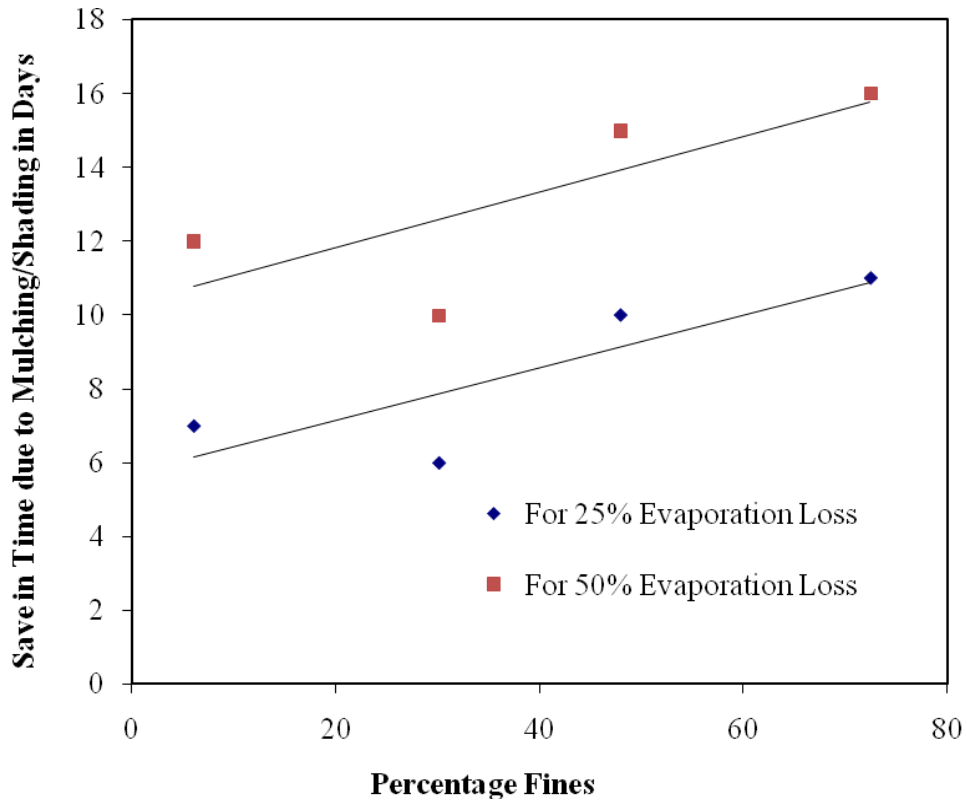
Fig 4.4 Variation of Evaporation Loss with Time for Soils Exposed to Direct Sunlight and Kept at Room Temperature

Fig. 4.5 shows the relation between percentage fines and the time for 25% and 50% evaporation obtained from the figure 4.4, from soils kept at room temperature and those exposed to sun light for soils S1,S2, S3 and S4. It was seen that the time required for evaporation increased with percentage finer.



**Fig 4.5 Relation between the Time for Evaporation and Percentage Fines**

Fig. 4.6 shows the save in time due to mulching/ shading with percentage fines for 25 and 50% evaporation from soils kept at room temperature and that exposed to sun light with percentage fines. It was seen that the mulching or shading rate increased with percentage fines.



**Fig 4.6 Effect of Mulching with Percentage Fines**

Variations of water content with time for all the seven soils are shown in figure 4.7. It can be seen that S2 which has a fine content of 72 % has the highest water holding capacity compared to that of other soils. From these graph we can get the water content at any time for the corresponding soils so that we can arrange the replenishment at the required time.

#### **4.3.4 Studies on Water Holding Capacity**

Fig 4.8 shows the variation of water content with texture for different types of soil with the increasing content of fines. From this figure the plant available water which is the difference between field capacity and permanent wilting point for soils ranging over sand, sandy loam, loam, silty loam, clayey loam and clay can be determined.

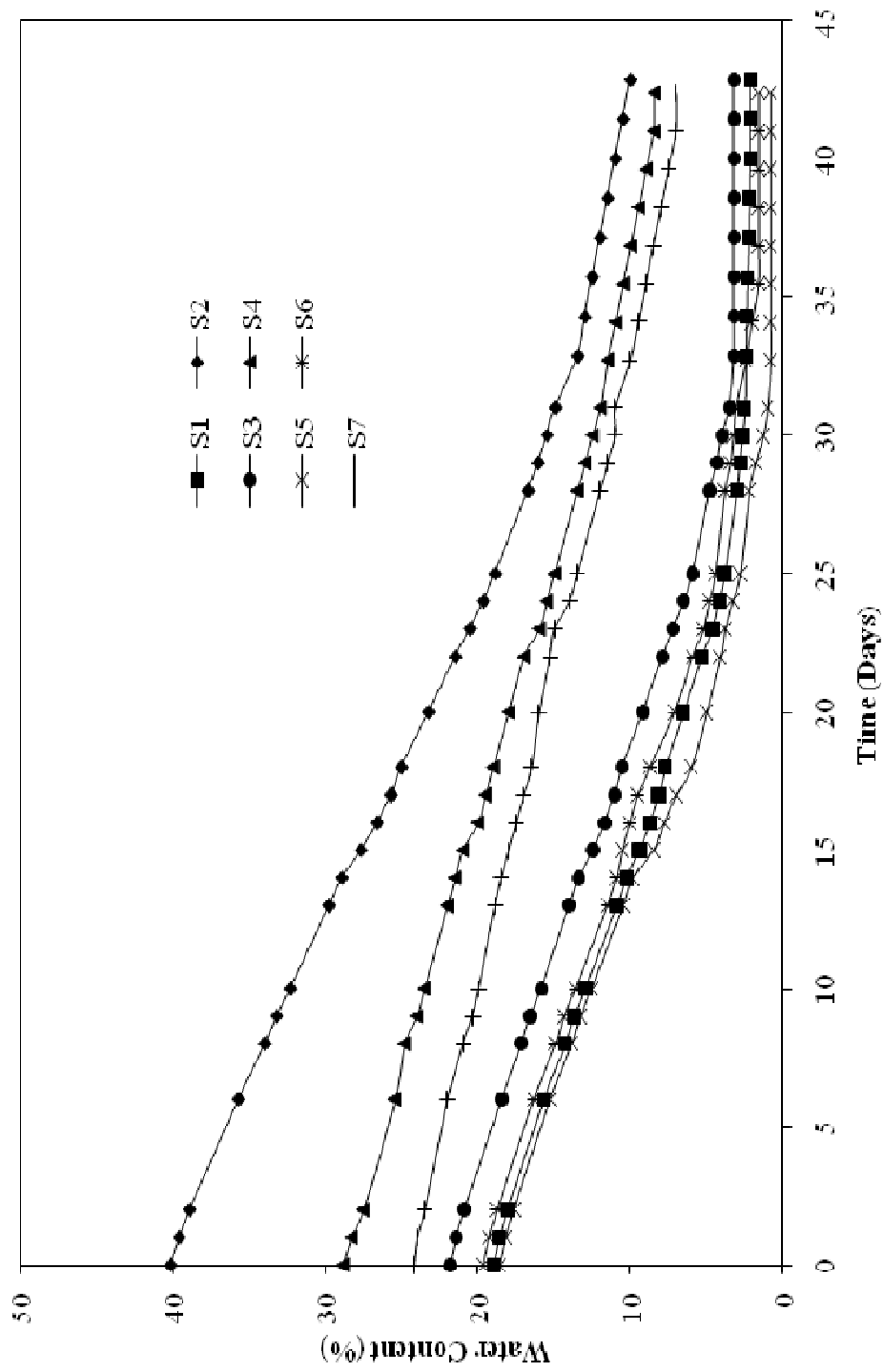


Fig. 4.7 Variation of Water Content of Soils with Time kept at Room Temperature



The field capacity and wilting point of all the seven soil samples were determined corresponding to their field densities using pressure plate apparatus by the method described in clause 3.3.1. Results of the tests are given in table 4.4 with the percentage of fines of soils and plant available water.

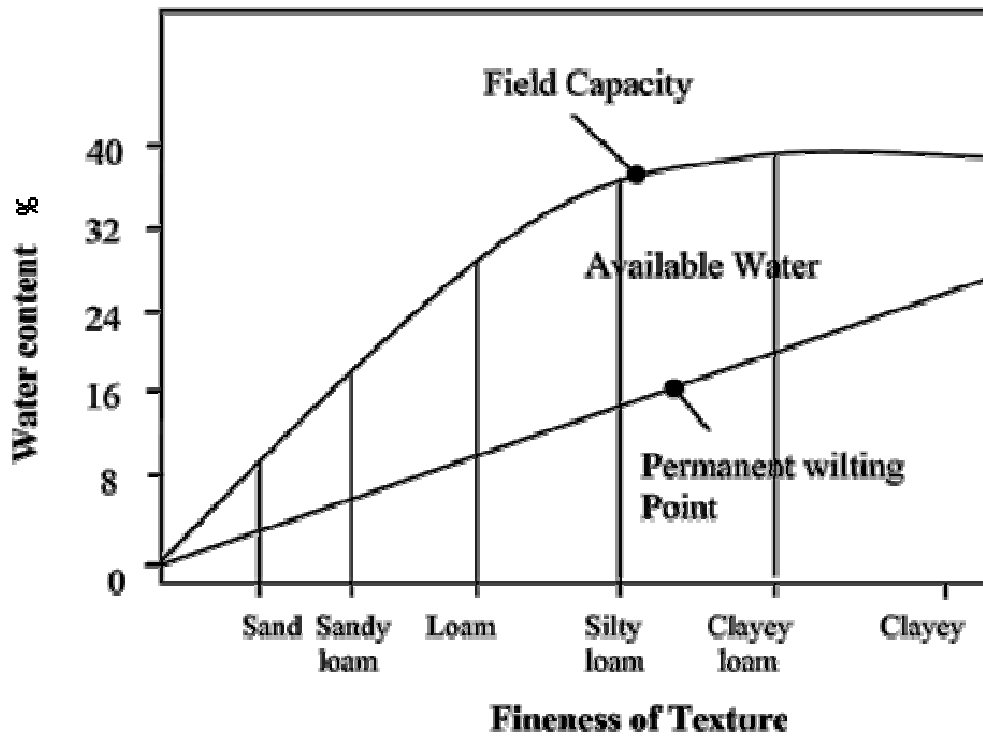
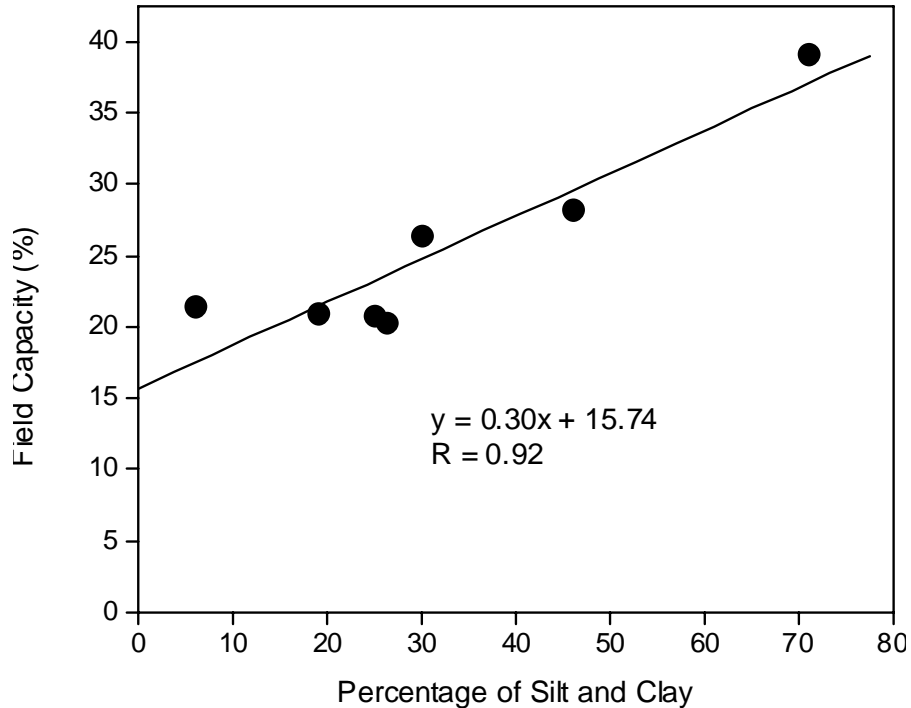


Fig.4.8. Variation of Water Content with Fineness of Soil

Table 4.4 Results of Available Water

Soil type	% of fines	Field capacity (FC) (%)	Permanent wilting point (PWP) (%)	Available Water (%) = FC – PWP
S1	30	20.25	9.15	11.10
S2	72	39.84	20.25	19.59
S3	6	21.42	9.78	11.64
S4	48	28.24	16.12	12.12
S5	23	20.40	10.30	10.10
S6	28	21.20	11.09	10.91
S7	44	23.13	11.03	12.10

A graph was plotted with percentage of silt and clay versus field capacity and it was seen that as the percentage of fine grained soil increases the field capacity also increases (Fig. 4.9).



**Fig. 4.9 Relation between Field Capacity with Percentage of Fines**

An equation is obtained for field capacity in terms of percentage fines of soil i.e.

$$F.C = 0.30F + 15.74$$

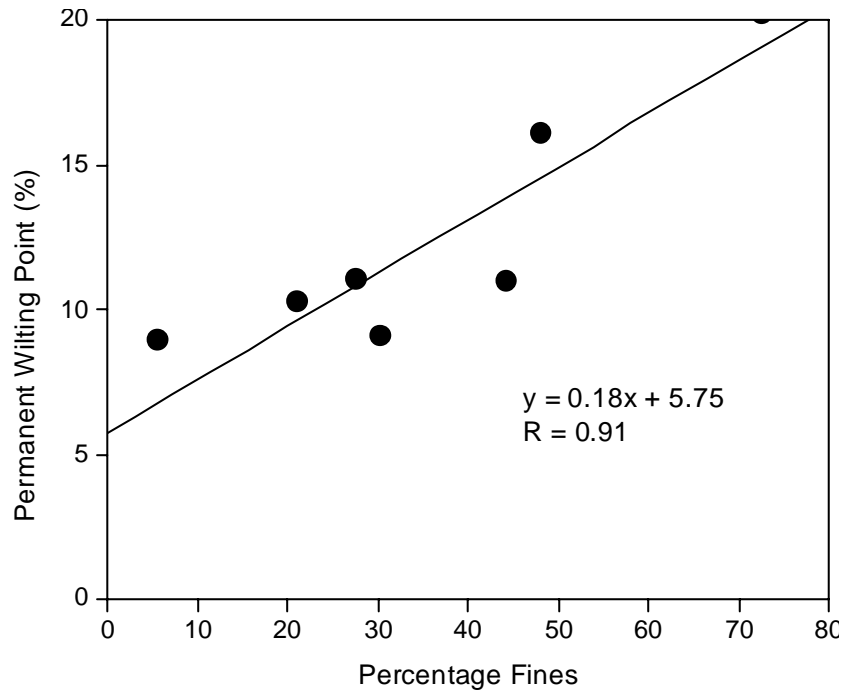
with correlation coefficient  $R = 0.92$

where

F.C is the field capacity and

F is the percentage of fines

Fig 4.10 shows the relation between permanent wilting point and percentage fines of soil and it was found that the soil available water is more for soils with high percentage of silt and clay.



**Fig. 4.10 Relation between Permanent Wilting Point and Percentage Fines**

An equation is obtained for permanent wilting point in terms of percentage fines of soil as:

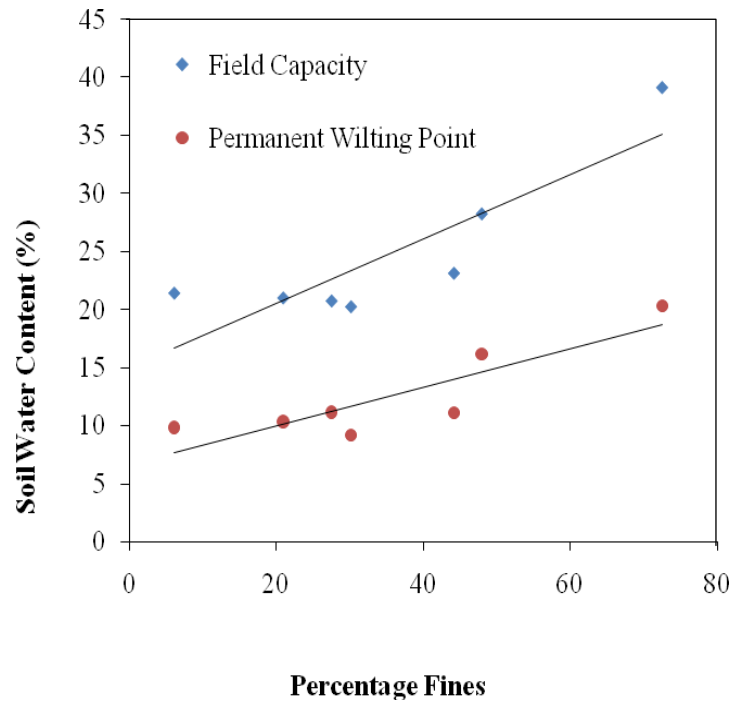
$$PWP = 0.18F + 5.75$$

with correlation coefficient  $R = 0.91$  where

PWP is the percentage water content at permanent wilting point and

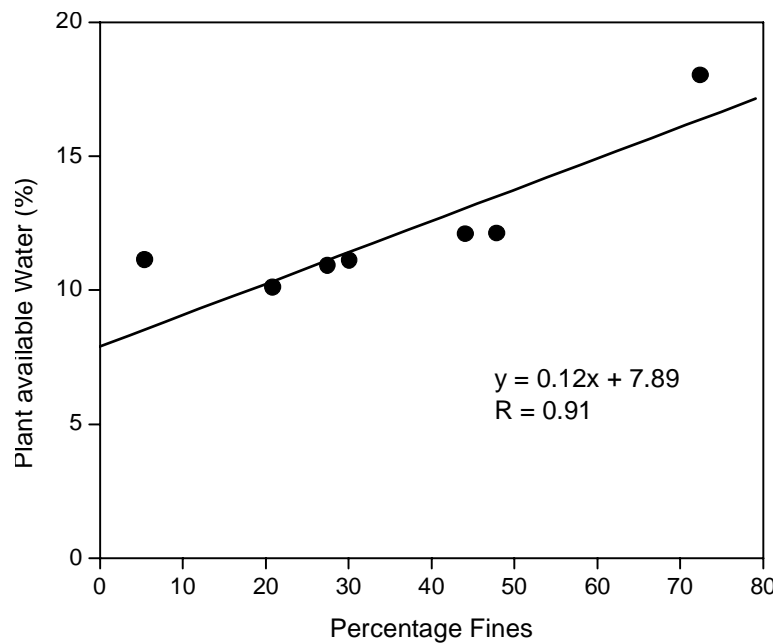
F is the percentage of fines.

Fig 4.11 shows the relation between soil water content and percentage fines at field capacity and permanent wilting point and it was found that the difference between field capacity and permanent wilting point (available water) increases with percentage of silt and clay.



**Fig. 4.11 Relation between Percentage of Soil Fines and Water Content**

Fig. 4.12 shows the relation between plant available water and percentage fines of soil. It was also found that the plant available water is more for soils with higher percentage of silt and clay.



**Fig. 4.12 Relation between Plant Available Water and Percentage Fines**

An equation is obtained for available water in terms of percentage fines of soil as :

$$PAW = 0.12F + 7.89$$

with correlation coefficient  $R = 0.91$

where

PAW is the percentage of plant available water and  
F is the Percentage fines

We can see that the available moisture in soil S2 is nearly twice that of soils S1 and S3 and larger than other soils. So it can be inferred that soil S2 has higher water retention capacity when compared to that of other soils. In the case of sandy soils, there are more macropores due to which the soil loses considerable amount of water through gravitational drainage. Consequently, many pores are open for aeration and little water remains for plant use before PWP is reached. But in the case of soil S2, they have enough macropores to provide drainage and aeration during wet periods, but also have adequate amount of micropores to provide water to plants between irrigation events. Also the organic matter (4.06%) present in S2 helps in holding and retaining large quantities of water.

From the results and discussions presented so far, it is obvious that the water retention capabilities are most influenced by the percentage of fines (ie silt and clay) than any other physical property .

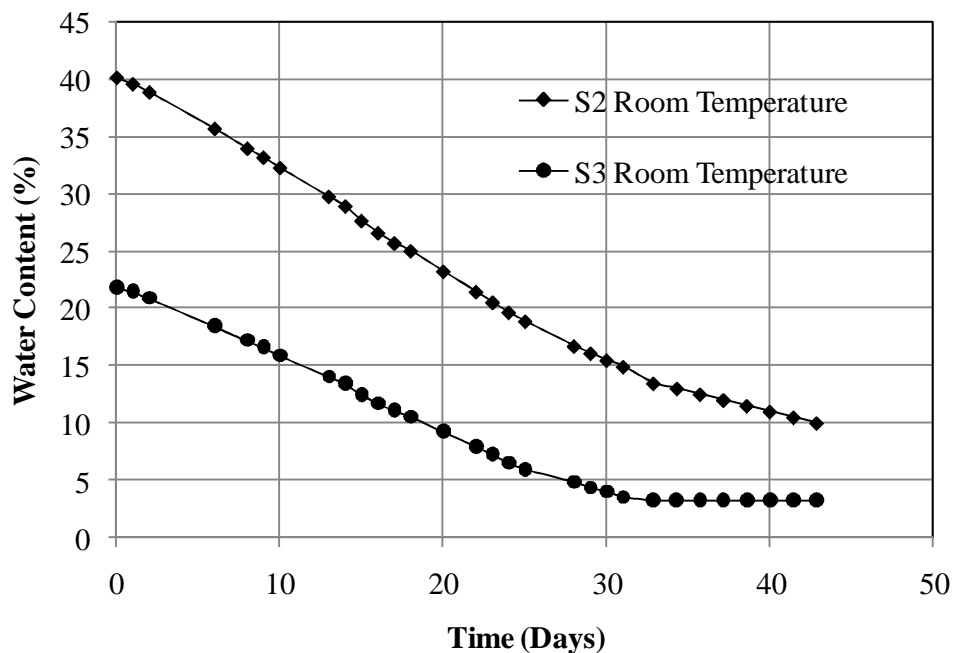
#### **4.3.5. Water Use Efficiency and Irrigation Interval**

Many irrigation projects were designed to supply water to each farm unit on a fixed and infrequent schedule rather than to make water continuously available on demand. The traditional mode of irrigation made good economic sense because many furrow, flood or portable sprinkler systems have a fixed cost associated with each application of water. With such systems, it is desirable to minimize the number of irrigations per season by increasing the interval of time between successive irrigations.

For high water use efficiency (WUE), maximum applied and stored water must be used as transpiration by crop and minimum amounts be lost by

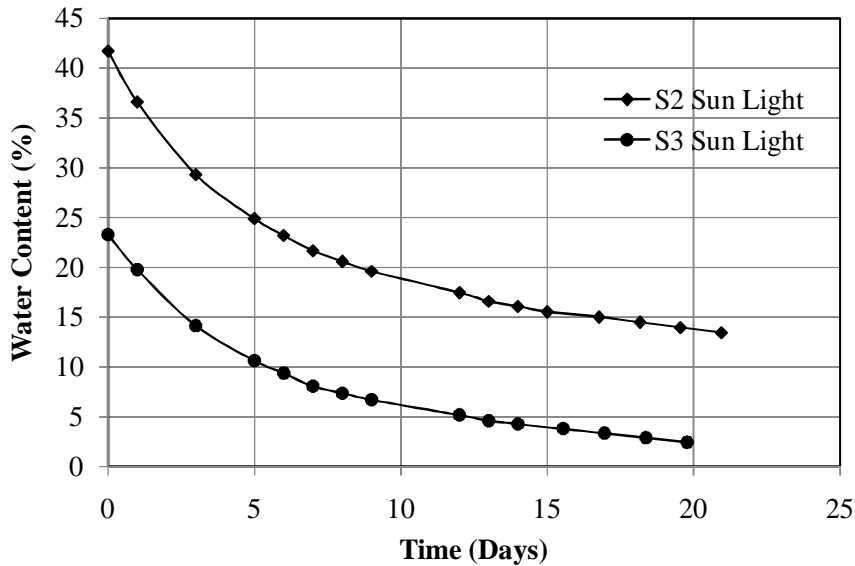
percolation and direct evaporation from soil. The plant roots absorb water from soil and transport it in to the leaves to be lost as transpiration to the atmosphere, while the green leaf area and atmospheric evaporativity govern the crop water demand, soil water status and water uptake capacity of roots determine the water supply to the crop. When the demand is fully met by supply, the plant performs to maximum capacity. But when supply falls short of demand, the plant shows wilting and its performance decline which reduces yield or quality. Irrigations are scheduled based on depletion of available water from effective root zone of the crops. Soil water tension, which is an energy index of soil water, has also been used as a criteria for scheduling irrigation to crops.

The classical questions involved in irrigation management are *when* to irrigate and *how much* water to apply at each irrigation. To the first question, this has been the traditional reply: Irrigate when the available moisture is nearly depleted. To the second question, the traditional reply was that apply sufficient water to bring up the moisture reserve of the soil root zone to field capacity, plus a “leaching fraction” of, say, 10 – 20% for salinity control.



**Fig: 4.13 Variation of Water Content with Time for S2 and S3 at Room Temperature**

To determine the irrigation interval, water content vs time graphs were plotted for the two typical soils S2 and S3 kept at room temperature and exposed to sun light as shown in Fig. 4.13 and 4.14.



**Fig 4.14 Variation of Water Content with Time for S2 and S3 Kept at Sun Light**

An equation is obtained from the best fit curve

For soil S2

$$w=0.084t^2-2.908t+38.99$$

with correlation coefficient R= 0.986 and

For soil S3

$$w= 0.071t^2- 2.304t + 21.6$$

with correlation coefficient R=0.987

where

w is the water content and

t is the time in days

From these equations we can determine the time at which the corresponding soil would reach a particular water content.

The permanent wilting point for soil S2 and S3 are 20.25% and 9.78% respectively. Providing 50% allowance for transpiration and other losses, the

permanent wilting point may be reached earlier i.e. 1.5times of the above PWP for S2 and S3 which are 30.38% and 14.67% respectively. The soil should be irrigated before reaching this water content for the healthy growth of plants and the time for irrigating the soil or the interval of irrigation is the time corresponding to the above value i.e. 3 days. Thus, knowing the evaporation loss, permanent wilting point and field capacity, one can fix the irrigation schedule for all types of soils.

#### **4.4 Soil Moisture Tension**

Soil moisture tension can be defined as the force per unit area that must be exerted to remove water from the soil. Therefore, it gives a measure of the tenacity with which water is retained in the soil. The higher the soil moisture content, lower is the tension and vice-versa. Certain soil moisture potential levels have particular significance in relation to the water holding capacity of the soil and to plant growth. The points of most practical importance are saturation, field capacity, moisture equivalent, wilting point, and oven dryness.

The field capacity is defined as the moisture content of the soil after downward movement of water has “materially decreased”. In mineral soils it may occur at widely varying tensions. For example, in sands at 100 cms, in loams at over 300 cms, and in clays at tensions of over 600 cms. The moisture equivalent is defined as the soil moisture content held against a force of 1000 times gravity in a specially designed centrifuge. This correlates closely with  $1/3$  atmosphere tension and is often taken as an approximation of the field capacity.

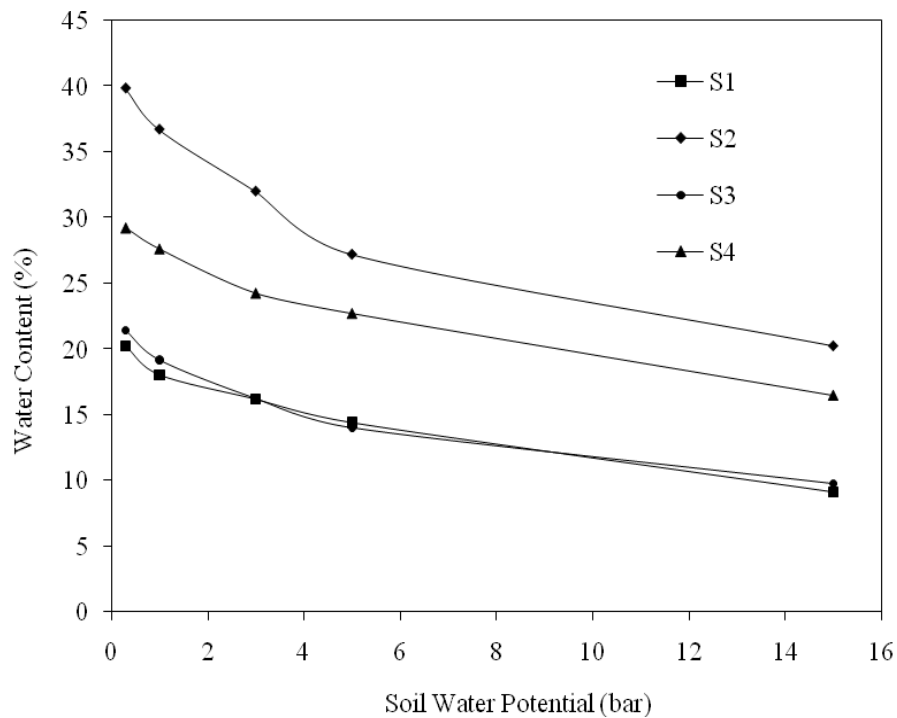
The wilting point may also vary widely depending on the suction head. While ranges between 7 and 32 atmospheres have been observed, 15 atmospheres is a satisfactory average. At this moisture level the potential of the plant root to absorb moisture is balanced by the moisture potential of the soil, and thus soil moisture is not available to the plant. Plants will be permanently wilted if the moisture in the root zone falls to the wilting point. Oven-dry soil has a moisture potential of 10000 atmospheres. The moisture content of the soil corresponding to a particular tension is influenced by soil texture, structure, soil solution and temperature. Therefore, soil moisture characteristic curves which give the relationship between the moisture content and the tension for different kinds of soils should be prepared for further use.



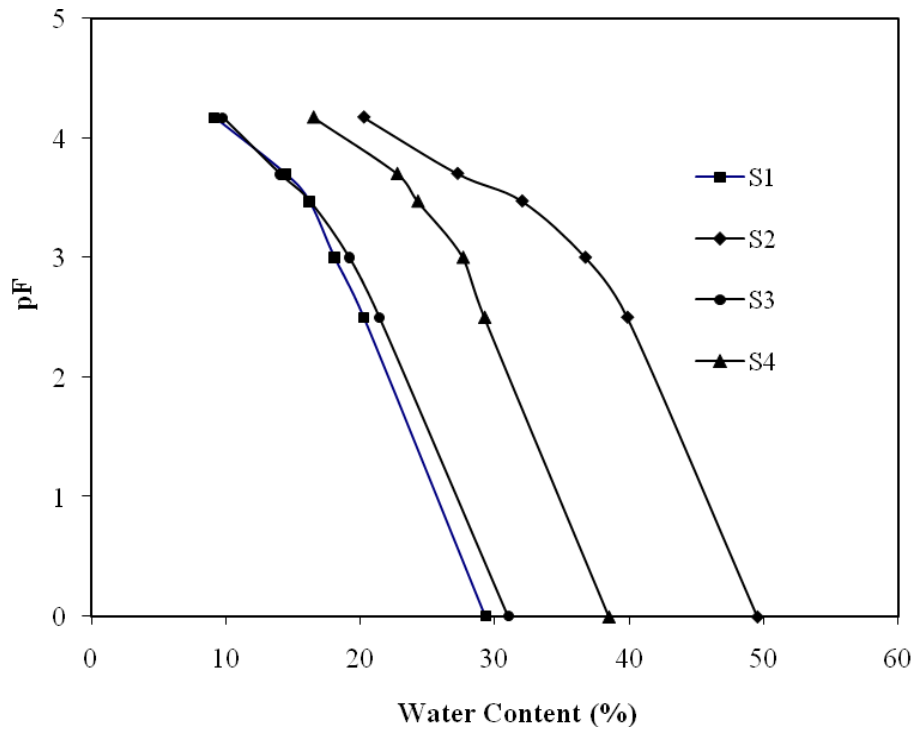
The SWRC (Soil Water Retention Curve) for the four soils at 0.33, 1, 3, 5 and 15bar pressure is shown in Fig. 4.15.

Fig 4.15 shows that soil S2 has the higher water content at .33 bar and 15 bar pressure application followed by S4, S1 and S3 respectively. The higher water potentiality of S2 may be due to the higher percentage of fine content and organic content. Knowing the water content at permanent wilting point (PWP) and measuring the actual water content of soils in the field one can easy determined the time for irrigating this soil.

The soil moisture potential often is referred to as the capillary potential, because in the high moisture range, the forces involved are primarily capillary forces. At tensions of 1000cm (pF value = 3) or more it is likely that the forces are primarily of molecular origin at the solid-liquid interfaces; at lower tensions, surface tension forces at the air liquid interfaces are dominant. Fig. 4.16 shows the relationship between pF value and moisture content of four soils.



**Fig. 4.15 Variation of Water Content of Soils with Water Potential**



**Fig. 4.16 Relationship between pF (Logarithm of pressure head in cm) value and Moisture Content of Soils**

**Table 4.5 Saturated Water Content and Field Capacity**

Soils	S1	S2	S3	S4	S5	S6	S7
% fines	30	72	6	48	23	27	44
$W_{sat}$ %	28.15	48.34	30.62	36.8	29.53	29.32	33.46
FC %	20.25	39.84	21.42	28.24	20.46	21.2	23.1
$W_{sat}$ -FC %	7.9	8.5	9.2	8.56	9.07	8.12	10.36

pF value is the logarithmic value of the water potential in cms. At saturated condition of the soil the pF value is zero and at over dried stage it is 5. The shape of the pF vs water content curve are similar for soils having similar texture.

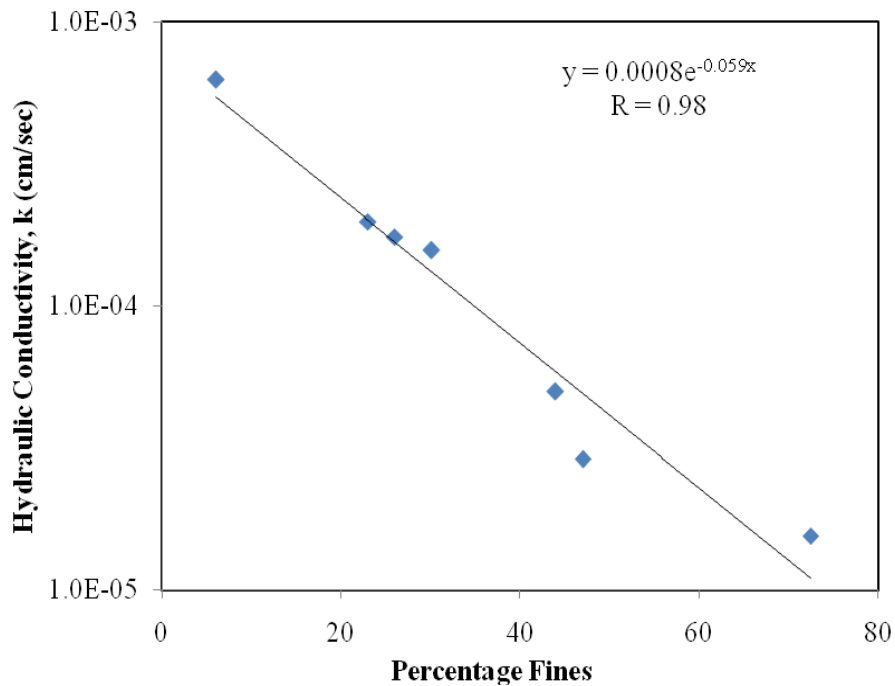
Table 4.5 shows the values of water content at fully saturated condition and the field capacity for the seven soils. The difference between the two values fall in the range of 7.92% to 10.36%. This does not show any specific trend with the fines content, it may be more dependent on the arrangement of pores.

#### 4.5. STUDY ON HYDRAULIC CONDUCTIVITY OF VARIOUS SOILS

The types of movement of water within the soil are recognized as saturated flow and unsaturated flow. Saturated flow takes place when the soil pores are completely filled with water. Unsaturated flow occurs when the pores in even the wettest soil zones are only partially filled with water. In each case, moisture flow is due to energy – soil relationship. The flow of water under saturated condition is determined by two major factors, the hydraulic force driving the water through the soil (commonly gravity) and the hydraulic conductivity or the ease with which soil pores permit water movement. The hydraulic conductivity of a uniform saturated soil is essentially constant and is dependant on the size and configuration of the soil pores. The average value of the saturated hydraulic conductivity of different soils using Rawe cell apparatus and odometer texts was shown in Table 4.6. As expected, the hydraulic conductivity of the soil S3 which is sandy in nature has the highest permeability and the soil S2 which has the highest fines content has the least permeability.

**Table 4.6. Hydraulic Conductivity of Various Soils**

Soil type	% of fines	Permeability (cm/sec)
S1	30	$1.57 \times 10^{-4}$
S2	72	$1.55 \times 10^{-5}$
S3	6	$6.28 \times 10^{-4}$
S4	48	$2.89 \times 10^{-5}$
S5	23	$1.98 \times 10^{-4}$
S6	26	$1.75 \times 10^{-4}$
S7	44	$3.50 \times 10^{-5}$



**Fig. 4.17 Relationship between Hydraulic Conductivity and Percentage Fines**

The permeability values of all the soils are presented in Table 4.6 and they are plotted in Fig. 4.17 in log scale against percentage fines. A correlation has been obtained between the two as given below.

$$k = 0.0008 e^{-0.058F}$$

where

k = permeability of soil (cm/sec) and

F = percentage fines

With a correlation coefficient of 0.98

#### **4.6. STUDY ON pH AND NUTRIENTS OF VARIOUS SOILS**

Of the thirteen essential elements obtained from the soil by plants, six are used in relatively large quantities and consequently receive first attention. They are nitrogen, phosphorous, potassium, calcium, magnesium and sulphur. Because they are used by plants in relatively large amounts, they are designated for convenience as macronutrients. Plant growth may be retarded if these elements are actually lacking

in the soil, or they become available too slowly, or they are not adequately balanced by other nutrients. Nitrogen, phosphorous and potassium are commonly supplied to the soil as farm manure or as commercial fertilizers. Therefore they are often called fertilizer elements. The other nutrient elements viz iron, manganese, copper, zinc, boron, molybdenum and chlorine are also used by plants but in very small quantities.

The soil samples collected after experiments were analyzed to find the effect on pH value, organic carbon and nutrients such as available nitrogen, potassium, phosphorus and calcium. Analyses were carried out in the Laboratory of Central Tuber Crops Research Institute, Thiruvananthapuram and Laboratory of Environmental Engineering, College of Engineering, Trivandrum as per standard procedures.

The ranges of pH and different nutrient parameters of soil are shown in section 2 (Tables 2.4 & 2.5). Values of pH ranges from 5.5 to 7.5. Values of pH and different nutrients such as organic matter, available nitrogen, potassium, phosphorus, calcium etc. for various soils are given in the table. Table 4.7 shows the comparison of different nutrient parameters before and after three months of watering for the four soils S1, S2, S3 and S4, selected for studies in detail.

**Table 4.7. OC, pH, NPK, CA and CEC Values of Soils on and after Three Months of Watering**

Soil type	OC%		Available N kg/ha		Available P Kg/ha		Available K Kg/ha		Available Ca Kg/ha		pH		Cation Exchange Capacity cmolkg <sup>-1</sup>	
	1	2	1	2	1	2	1	2	1	2	1	2	1	2
S1	0.3	0.29	46.38	46.30	44.38	44.38	53.76	56.70	666.18	665.12	5.09	5.12	9.96	9.89
S2	1.36	1.35	240.00	239.01	12.36	12.30	380.8	380.01	1101.18	998.93	5.18	5.29	24.10	24.00
S3	0.14	0.14	126.00	125.8	8.24	8.23	188.16	188.01	285.60	283.71	5.28	5.30	3.35	3.35
S4	0.48	0.45	70.00	70.00	131.18	131.00	239.68	236.10	568.51	565.31	5.10	5.11	16.81	16.79

1 represents values of soil before watering.

2 represents the values of soil after three months of watering

From the table we can see that there are no significant differences between the values OC, pH , NPK , CA and CEC of soils after three months of watering.

From Table 4.8 we can see that for all the soils S1,S2, S3 and S4 the pH value is less than 5.5 and it denotes that it is acidic in nature and it can be amended by suitable treatments with admixture or manures to achieve a neutral value. The organic content in S2 is higher than the normal value. It shows that soil S2 has a high fertiliser value in organic content and the fertiliser dosage of organic matter can be reduced. The available potassium for S2 is lower than the lower limit of N. It also can be improved by suitable fertilisers. The potassium content of S1 is lower than the lower limit of potassium and it can be improved by the proper treatment. The calcium content of S3 and S4 are lower than the lower limit for that and that also required treatment. The pattern of ion exchange capacity are lower for S1 and S3.

#### **4.7. QUALITY OF WATER**

Quality of water refers to its degree of suitability for a specific purpose and it largely depends on its physico-chemical composition. Quality of water for irrigation refers to the degree of suitability for crop growth and it depends on nature and amount of dissolved salts which contain relatively small but important amounts of dissolved salts originating from dissolution of weathering rocks and soil and dissolving of lime, gypsum and other salt sources, as water passes over or percolates through them.

The quality of water used in the experiment was subjected to physico chemical analysis. The properties of water used in the study such as pH, total dissolved solids, acidity, alkalinity etc were determined by using IS methods and summarized in Table 4.8. It also shows the comparison between the water used in the study and effluent water collected after 3 months.

**Table 4.8 Comparison between Water Used and Effluent Water**

Parameter that control Quality Characteristics	Parameter of Water Used	Range of parameter as per Standard	Parameter of Effluent Water after 3 Months for Soils			
			S1	S2	S3	S4
pH	7	6.5 to 8.5	6.8	6	7	6.8
Total dissolved solids	130.0 ppm	500.0 – 2000.0 ppm	840	650	540	640
Total hardness (as CaCO <sub>3</sub> )	60.0 ppm	300.0 – 600.0 ppm	120	160	38	140
Fluoride (as F)	Nil	1.0 – 1.5 ppm	Nil	Nil	Nil	Nil
Acidity	-	-	-	-	-	-
Alkalinity	70.6 ppm	200 – 600 ppm	16.2	7.8	27.3	27.3
Iron (as Fe)	0.3 ppm	0.3 – 1.0 ppm	0.3	Trace	.1	.4
Chloride (as Cl)	33.75 ppm	250.0 – 1000.0 ppm	160	101	115	192
Sulphates (as SO <sub>4</sub> )	Nil	200.0 – 400.0 ppm	20	15	50	30
Residual free Chlorine	Nil	0.2 ppm	Nil	Nil	Nil	Nil
Nitrate (as NO <sub>3</sub> )	2 ppm	45.0 ppm	Trace	1	Trace	Trace

It can be seen from the table that the constituent properties of the water, when it seeps through the four soils register certain changes. The water turns slightly acidic as shown by the pH value and alkalinity. Both the total dissolved solids and total hardness increase. The iron content shows inconsistent changes. Chloride and sulphate get increased while nitrate gets reduced. Thus water when it seeps through this soils change their characteristics to some extent. This indicates that the water that is used for irrigation and water that reaches the root system of soil may have different characteristics.

The physical and chemical properties of the soil affect many processes in the soil that make it suitable for agricultural practices and other purposes. The texture, structure and porosity influence the movement and retention of water, air and solutes in the soil, which subsequently affect plant growth and organism activity. Most soil chemical properties are associated with the colloid fraction and



affect nutrient availability, growing conditions, and, in some cases, soil physical properties. Biological properties in the soil contribute to soil aggregation, structure and porosity, as well as decomposition of soil organic matter and mineralization. Organism activity is controlled by various soil conditions and may be altered by management practices. Since many soil properties are interrelated with one another, it is difficult to draw distinct lines of division where one type of property dominates the behaviour of the soil. Therefore, understanding and recognising the soil properties and their connection with one another is important for making sound decisions regarding soil use and management.

---

## **STUDIES ON RETENTION CAPABILITY OF TREATED SOILS**

---

### **5.1. INTRODUCTION**

Water is the major input for the growth and development of all types of plants. Because of the growing shortage of water resources, the water scarce countries will have to use the available water efficiently by proper water management. Better utilisation of rainfall/irrigation depends largely on the water retention characteristics of the soil. Soil texture, organic matter and cation exchange capacity, to a large extent determine the water retention/release and infiltration rates of a soil. The water movements in the unsaturated zone, together with the water holding capacity (field capacity) of the zone, are very important vis-a-vis the water demand of the vegetation.

#### **5.1.1 Parameters for Selection of Admixtures**

The available water capacity is an important hydrological characteristic of a soil and it is often used as a basis for the evaluation of different soils and melioration treatments. A major factor of soil water management, which can influence the available water capacity, is the field capacity. The amount of water remaining in the soil after all gravitational water has drained off is called the field capacity. Improvement in field capacity increases the available water to the plants. However an increase in field capacity can be achieved by improving the soil composition or texture and it can be provided by organic amendments (admixtures). The function of the admixture is to change the soil texture and thereby increase the water holding capacity and certain other chemical properties of the soil. The admixtures find application as an amendment in problem soils such as those with poor moisture retentivity, poor drainage and aeration, salinity, alkalinity etc.

Selection of an admixture depends upon many factors such as soil texture and porosity, crop type, organic content, moisture condition, nutrient content and rapid fermentative process of the admixture. As different kinds of organic matter may be

added to the soil for agro- environmental purposes, they may differently affect both the soil water retention values and their temporary changes and the nutrient condition. With this in view, three admixtures coir pith - a byproduct of coir industry, coir pith compost - a manure developed from coir pith and vermi compost - an excreta of earth worm, which has a far higher fertilizer value, were selected for the present study. An attempt has been made here for a comparative assessment of the efficiency of the above three admixtures in promoting water retention and nutrient capabilities of soils.

### **5.1.2 Coir Based Admixtures**

India is one of the leading countries of the world in the production of coconuts. The area under coconut has been steadily increasing and in Kerala the annual production of coconut is close to 5000 million. Though the nut and coir are considered to be the economic product, the other parts of the coconut like the coir pith consisting of dust and bits of fibres of lesser length are considered as waste and dumped on the land in mounds. The tannins that ooze out from the dump yards during monsoon, are a major concern as they create environmental pollution problems.

Attempts have been made by the Central Coir Board of India and other agencies in the public sector and coir industrialists in the private sector to find better ways and means of utilisation of this waste material. The abundant availability of coir pith in the southern states, the problems associated with its disposal and environmental pollution, and the physico-chemical characteristics of the material attracted the attention of the agriculturists and technologists to find an application for this waste material.

Present indications are that this waste material can become an important source of organic matter. The current boom in fertilizer prices and such other considerations necessitated the development of a programme for organic based recycling in agriculture. This review prompted the farmers, scientists as well as the owners of the coir industries to use coir pith in agricultural activities. The very attractive moisture retention properties of coir pith and availability in abundance drew their attention for its large scale use as an organic material that can improve the soil properties.

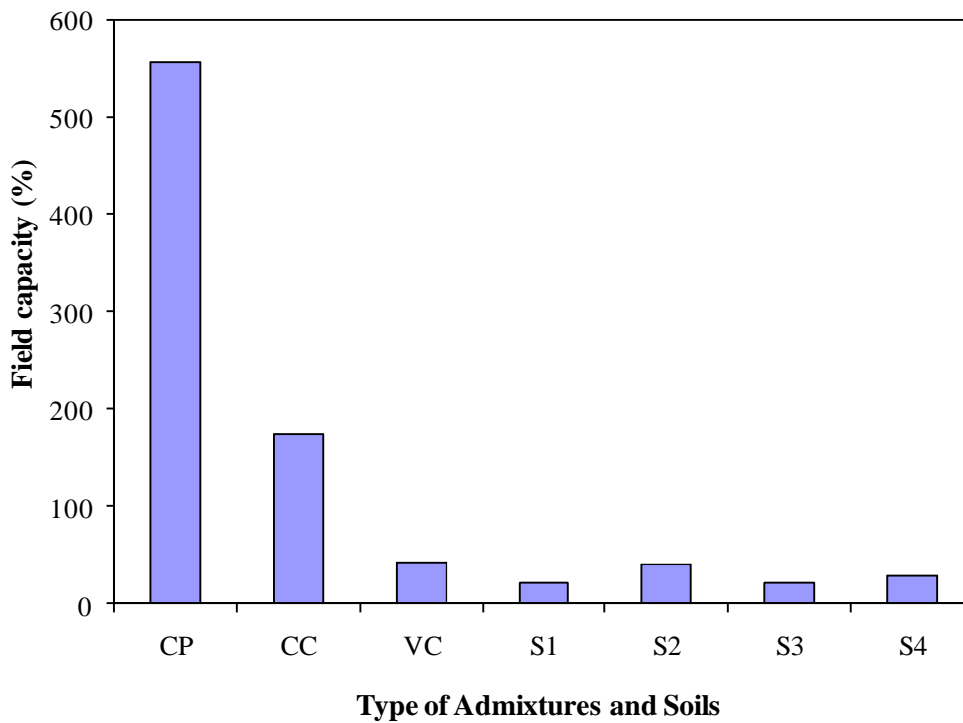
## 5.2. STUDIES ON ADMIXTURES

When an admixture is incorporated into a soil, its organic matter undergoes microbe-induced changes, triggered by soil structural and micro environmental factors. The admixtures selected for the study as mentioned above were coir pith, coir pith compost and vermi compost. Though coir pith is difficult to biodegrade, its phenomēni moisture retention properties made the scientists and farmers to use it as an ameliorant for improving the soil properties. Coir pith compost is also a product developed from coir pith to reduce its volume and increase its biodegradability. Vermi compost is an excreta of earthworm largely used as a farm manure. The chemical properties of the selected admixtures are given section 3.2.3 (Table 3.6) and the water retention characteristics of admixtures and soils are given in Table 5.1. The histograms in Fig. 5.1 shows that the water retention capacity of coir pith is several times higher than that of vermi compost.

From the Tables 5.1 and 5.2, it can be seen that coir pith has a very high field capacity of 556.2% and a high value of organic carbon so that it can be used as an organic manure with high water retention capacity. The higher value of C:N ratio of 112:1, offers stiff resistance to microbial degradation. Coir pith compost and vermin compost have very good N, P and K values and low C:N ratio which indicate the potential of that as a fertilizer. From Table 5.2, Soil S2 has the highest field capacity and plant available water compared to soils S1, S3 and S4.

**Table 5.1 Water Retention Characteristics of Admixtures and Soils**

Name of Admixtures and Soils	Designation	Field Capacity FC (%)	Permanent Wilting Point PWP (%)	Plant Available Water PAW (%)
Coir Pith	CP	556.20	253.45	302.75
Coir Pith Compost	CC	174.20	59.72	114.48
Vermi Compost	VC	41.20	20.10	21.00
Sandy Loam	S1	20.25	9.15	11.10
Silty Clay Loam	S2	39.84	20.25	19.59
Sand	S3	21.42	9.78	11.64
Sandy Clay Loam	S4	28.24	16.12	12.12



**Fig. 5.1 Field Capacities of Different Admixtures and Soils**

### **5.3. STUDIES ON SOILS TREATED WITH ADMIXTURES**

The admixtures used for the study were added at 1, 3, 5 and 10% by dry weight to the soils S1, S2, S3 and S4. The soils with the admixtures were filled at the relative density approximately equal to that of normal field conditions, in the cylindrical containers in the same method mentioned in article 3.3.1 for the four soils. The soil samples were saturated and allowed to drain to the field capacity at room temperature. The water content of the specimens was measured each day to find the loss of water content, for a period of 30 to 35 days until loss of weight was found to be negligible.

The field capacity and permanent wilting point of the four treated soil samples were determined by using pressure plate apparatus by the method described in detail in article 3.3.2 and the results of that with 10% admixtures are given in Table 5.2.

**Table 5.2 Improvement of Plant Available Water with admixtures**

<b>Soil type</b>	<b>Field capacity (FC)</b>	<b>Permanent wilting point (PWP)</b>	<b>Plant available water (PAW)</b>	<b>Percentage increase in PWP</b>
S1	20.25	9.15	11.1	-
S1 + 10% CP	54.71	24.87	29.84	268.8
S1 + 10% CC	42.77	19.02	23.75	213.9
S1 + 10% VC	28.05	12.75	15.3	137.8
S2	39.84	20.25	19.59	-
S2 + 10% CP	78.19	35.54	42.65	217.7
S2 + 10% CC	67.94	33.91	34.03	173.7
S2 + 10% VC	43.94	19.97	23.97	122.35
S3	21.42	9.78	11.64	-
S3 + 10% CP	53.62	24.37	29.25	251.28
S3 + 10% CC	44.75	21.34	23.41	201.11
S3 + 10% VC	29.37	13.35	16.02	137.62
S4	28.24	16.12	12.12	-
S4 + 10% CP	46.89	21.31	25.58	211.05
S4 + 10% CC	51.12	25.98	25.14	207.42
S4 + 10% VC	34.15	15.52	18.63	124.17

It has been already reported in literature (Namasivayam and Sangeetha 2006) that excessive use of additives may alter the very characteristics of the soil drastically. There can also be chemical interactions between soils and the additives, whose products / results may affect plant growth. Hence a ceiling on the maximum percentage is essential and many research workers recommend 10% by dry weight of the soil. Hence investigations have been carried out in this work selecting 1, 3, 5 and 10 percentages for the three admixtures – coir pith, coir pith compost and vermi compost.

### 5.3.1. Studies on Soils Treated with Coir Pith (CP)

The soils S1, S2, S3 and S4 were treated with CP in varying percentages and kept at room temperature in containers to determine the evaporation losses of the treated soils. These variations were plotted with water content vs time. Fig 5.2 shows the variation of water content with time for soil S1 when mixed with 1, 3, 5 and 10% of CP. It can be seen from the curves that there is drastic improvement in the water holding capacity of this soil. For the unamended soils, the field capacity was only 20.25%. On treatment with 10% CP, the field capacity increased to 54.71% which is 2.7 times that of S1 alone. There is a steady increase in field capacity for addition of 1, 3, 5 and 10% of CP. The trend of evaporation curves is quite similar to the original soil. It can also be noted that as in the case of original soil, the amended soil also reaches a steady state wherein evaporation loss is nil or very negligible. The only difference is the time taken for this which is about 30 days for the soil alone while it increases to 45 days for soils treated with 10% of coir pith .

From table 5.2 it can be seen that the permanent wilting point (PWP) for soil S1 is 9.15% giving plant available water (PAW) of 11.1%. When S1 is treated with 10% CP, the PWP improves to 24.87% and the PAW is as high as 29.84%. This means the PAW which was 11.1% for the soil alone improves to 29.84% which is almost three times as that of soil alone. This clearly brings out the enormous advantages of treatment of soils with CP, not only to increase the plant available water but also the irrigation interval, bringing in considerable saving in irrigation water.

Fig 5.3 shows the water content - time relationship for soil S2 treated with CP. This soil has a higher content of fines - 72.45% - as against 30.11% of S1. Due to the higher fines content, it has a higher field capacity of 39.84% and PWP of 20.5%. Table 5.3 shows that on treatment with 10% CP, the field capacity increases to 78.19% which is about two times. The PAW improves from 19.59% to 42.65% which is 2.2 times the value of untreated soil S2. It can also be noted that while the improvement in PAW was about 3 times for S1, it is only 2.2 times for S2. This is due to the higher content of fines in S2 which shows that the admixtures are more effective with coarse grained soils than fine grained soils.

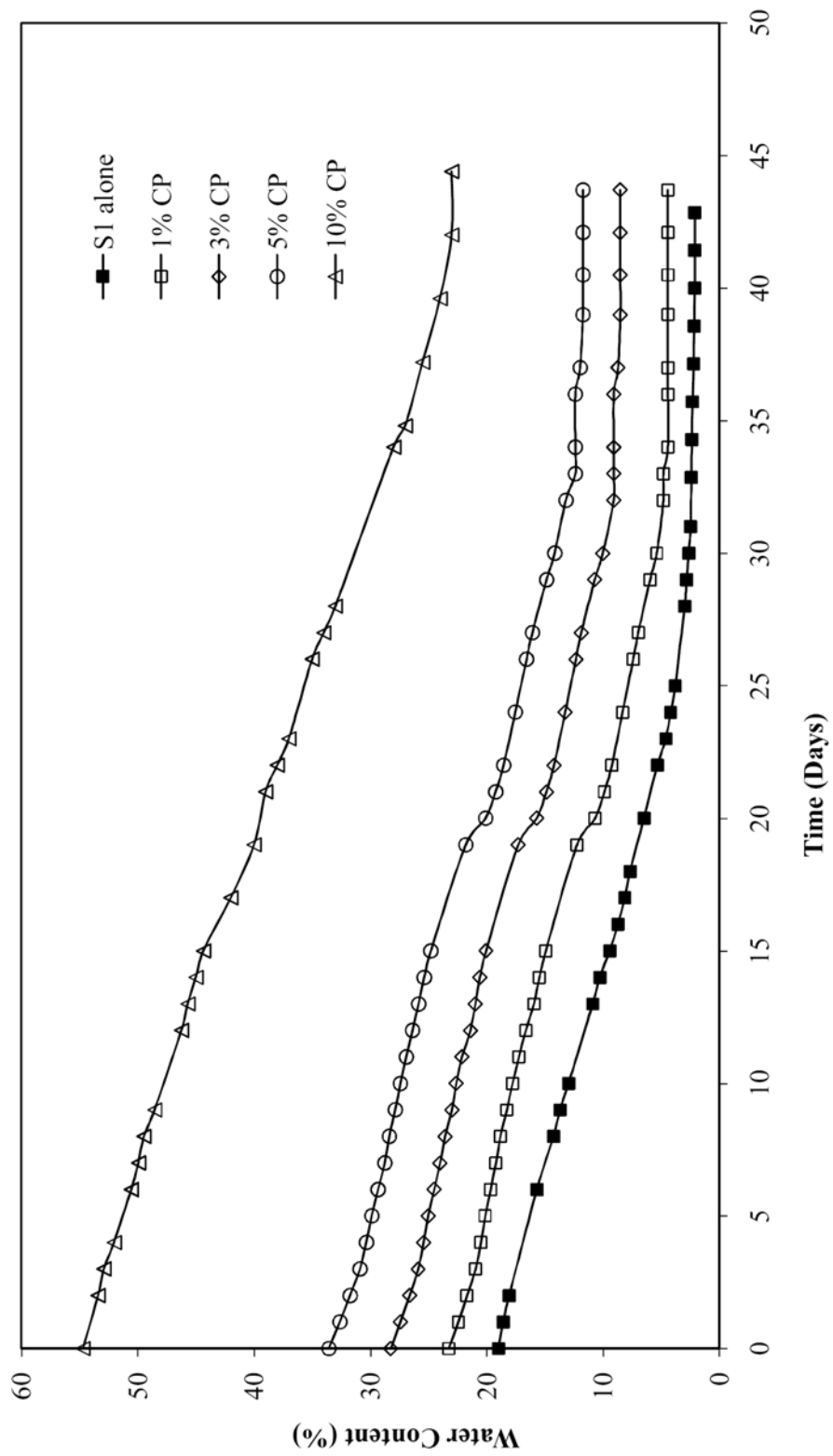


Fig. 5.2 Variation of Water Content with Time for S1 Mixed with CP



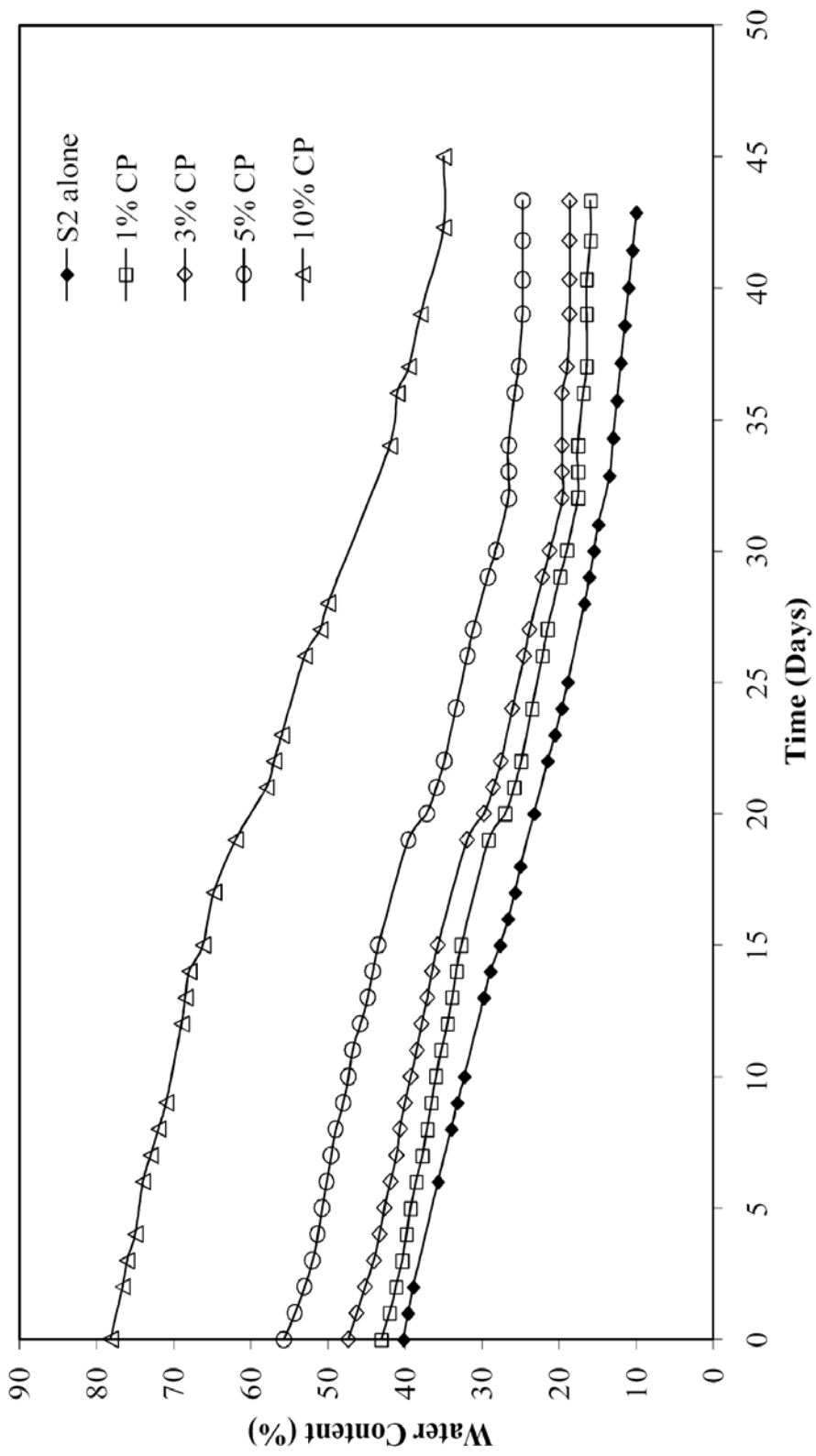


Fig. 5.3 Variation of Water Content with Time for S2 Mixed with CP

Fig 5.4 gives the relationship between water content and time for soil S3. The field capacity for soil S3 is 21.42% and PWP is 9.78%. These values improved to 53.62% and 24.37% respectively showing an improvement by 2.5 times for both. The PAW increases from 11.64% to 29.25% which is almost 3 times. Soil S3 has only 6.06% of fines and is obviously sandy in nature. As indicated by the above results and in comparison with soils S1 and S2, this treatment is more effective for sandy soils as mentioned earlier.

Fig 5.5 presents the results on water content vs time relation ship for different percentages of CP for soil S4. It can be seen that the results are in good agreement with those presented above for the other three soils taking in to consideration the percentage of fines present in the soil.

### **5.3.2. Improvement in Irrigation Interval with Amixtures**

The aim of treatment of soils with admixtures is to improve its water holding capabilities and consequent saving in irrigation water. When water content in soil falls below PWP, plants will start showing distresses and may ultimately die out. Therefore the water content in the soil shall not fall below certain lower limits and these limits along with the rates of evaporation losses decide the interval at which irrigation has to take place. If the water holding capacity is higher, the irrigation interval can be longer. How the admixtures can increase the irrigation interval is discussed below:

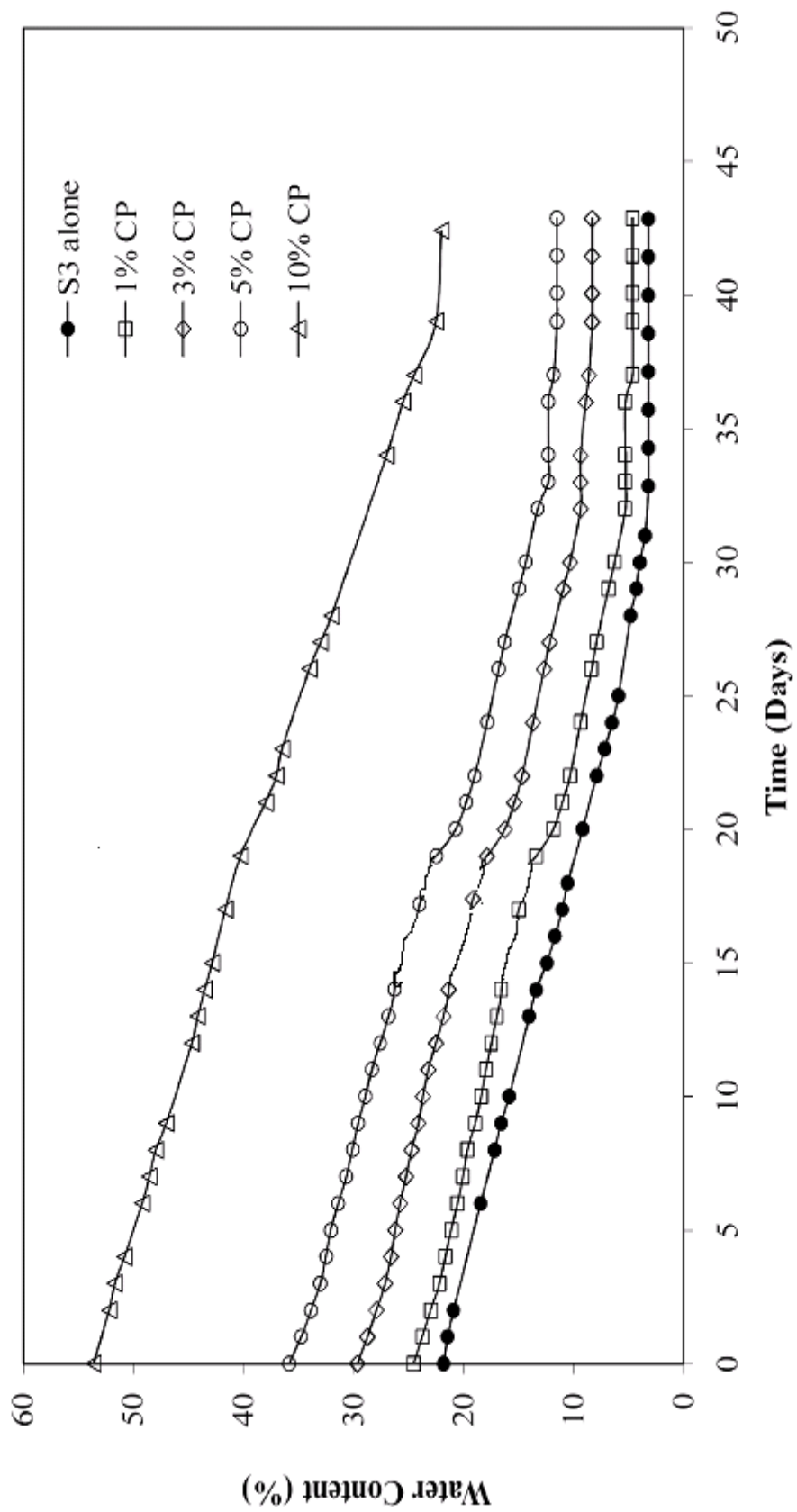


Fig. 5.4 Variation of Water Content with Time for S3 Mixed with CP

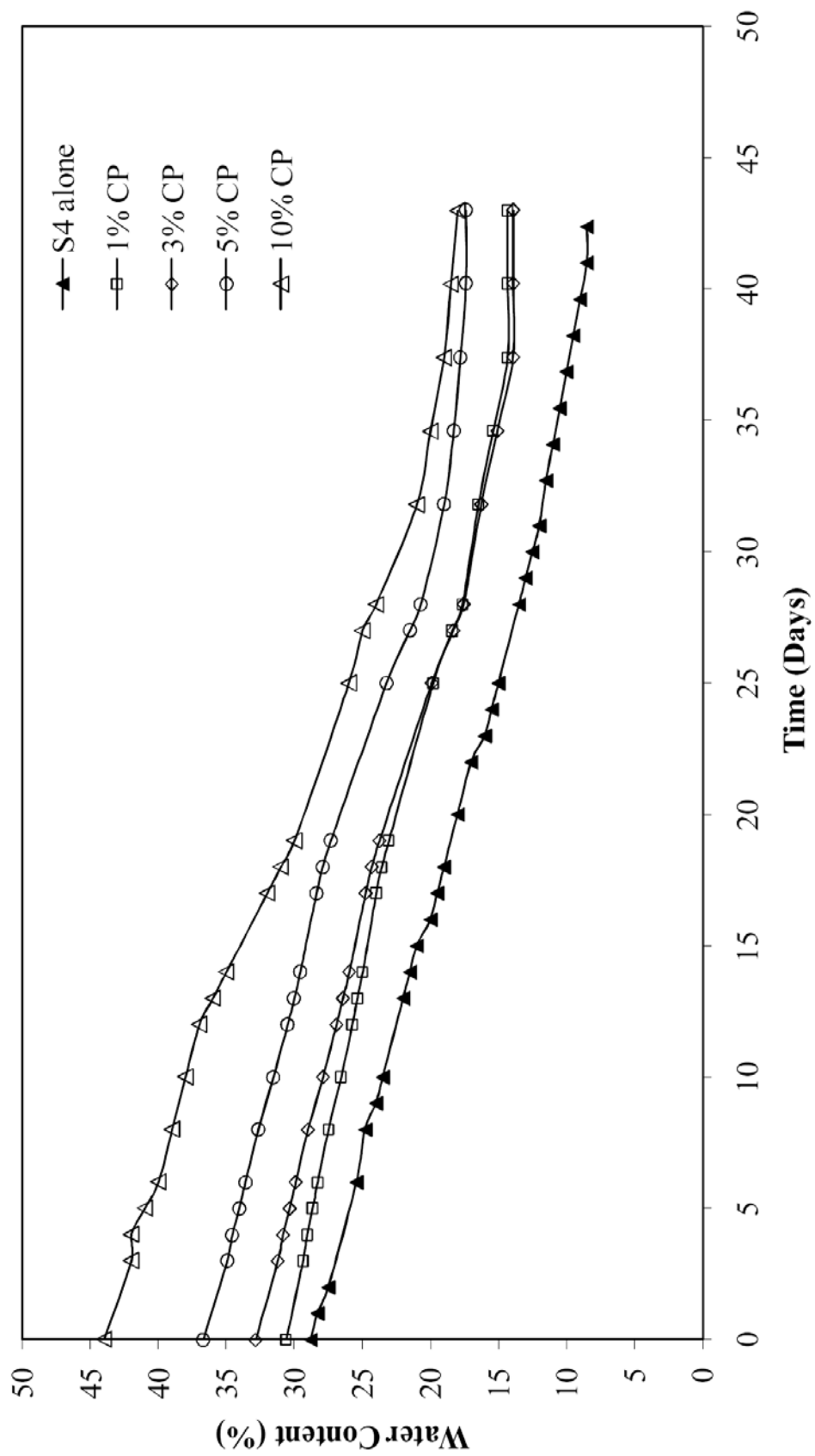


Fig. 5.5 Variation of Water Content with Time for S4 Mixed with CP

Fig. 5.6 shows the relationship between water content after 10, 20 and 30 days evaporation for percentages of coir pith added. These two have an excellent linear relationship. For a predetermined water content at a predetermined irrigation interval, we can determine the percentage of coir pith to be added. For example, if the lowest water content permissible is 20% and the irrigation interval is 10 days the admixture needed is 2% CP only to soil S1. If the irrigation interval is 20 days, the CP added shall be 4.3%. To obtain an irrigation interval of 30 days the CP required to be added is 6.4%.

From the above curve, a linear equation can be obtained for 10 days irrigation interval as given below:

$$w = 3.457CP + 12.73 \text{ with } R = 0.992$$

where; w = water content

CP = percentage of coir pith

R= correlation coefficient

For 20 days irrigation interval,

$$w = 3.215CP + 6.256 \text{ with } R = 0.993$$

If the irrigation is 30 days,

$$w = 2.805CP + 1.966 \text{ with } R = 0.994$$

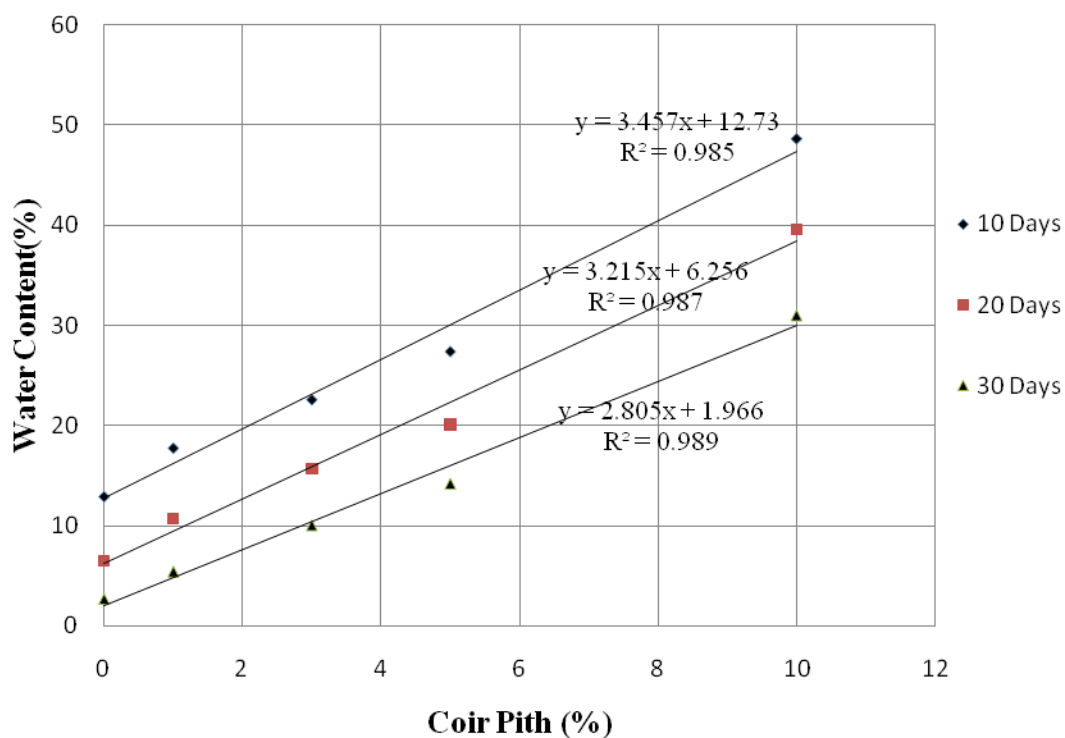
From the curves in Fig 5.6 and the above equations, we will be able to arrive at the CP content required for prescribed values of water content and irrigation interval.

Fig 5.7 gives the relationship between water content and percentage of CP for soil S2 for irrigation intervals of 10, 20 and 30 days. The relationships give rise to the following equations for 10, 20 and 30 days irrigation interval respectively for soil S2.

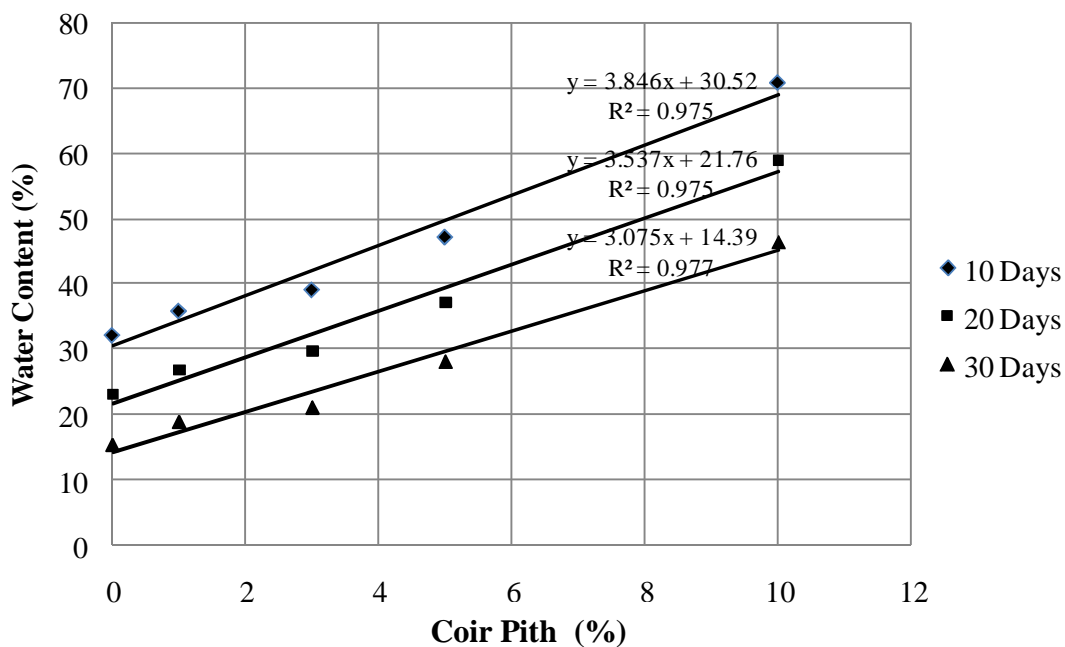
$$w = 3.846CP + 30.52 \text{ with } R = 0.987$$

$$w = 3.537CP + 21.76 \text{ with } R = 0.987$$

$$w = 3.075CP + 14.39 \text{ with } R = 0.988$$



**Fig 5.6 Percentage of Coir Pith Vs Water Content for S1 after 10, 20 and 30 Days**



**Fig 5.7 Percentage of Coir Pith Vs Water Content for S2 after 10, 20 and 30 Days.**

Fig. 5.8 and 5.9 give similar relationships for soil S3 and S4. For these soils, the corresponding equations are:

For S3,  $w = 3.062CP + 15.02$  with  $R = 0.996$

$w = 2.994CP + 8.093$  with  $R = 0.991$

$w = 2.704CP + 2.95$  with  $R = 0.991$

And for S4,

$w = 1.393CP + 24.2$  with  $R = 0.992$

$w = 0.893CP + 20.43$  with  $R = 0.901$

$w = 0.8714CP + 14.42$  with  $R = 0.920$

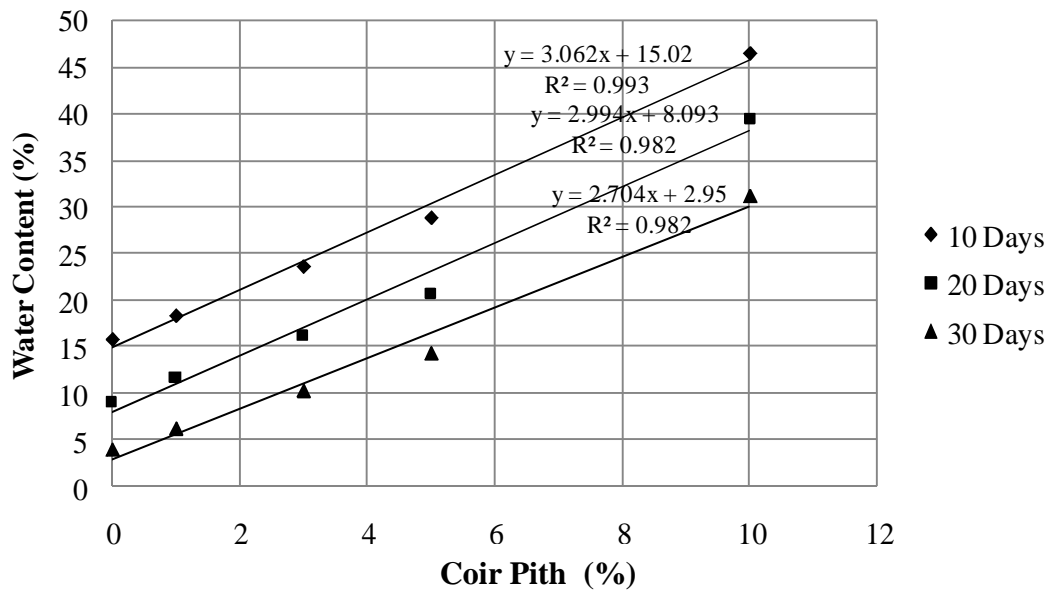
### **5.3.3. Studies on Soils Treated With Coir Pith Compost**

It has been discussed in the literature ( Savithri and Khan, 1994) that the ratio of carbon to nitrogen is the yard stick for measurement of fertility of soil. This ratio has to be kept minimum to facilitate rapid fermentative process. Even though the water holding capacity of CP is as high as 552.2%, its C: N ratio is 112:1.

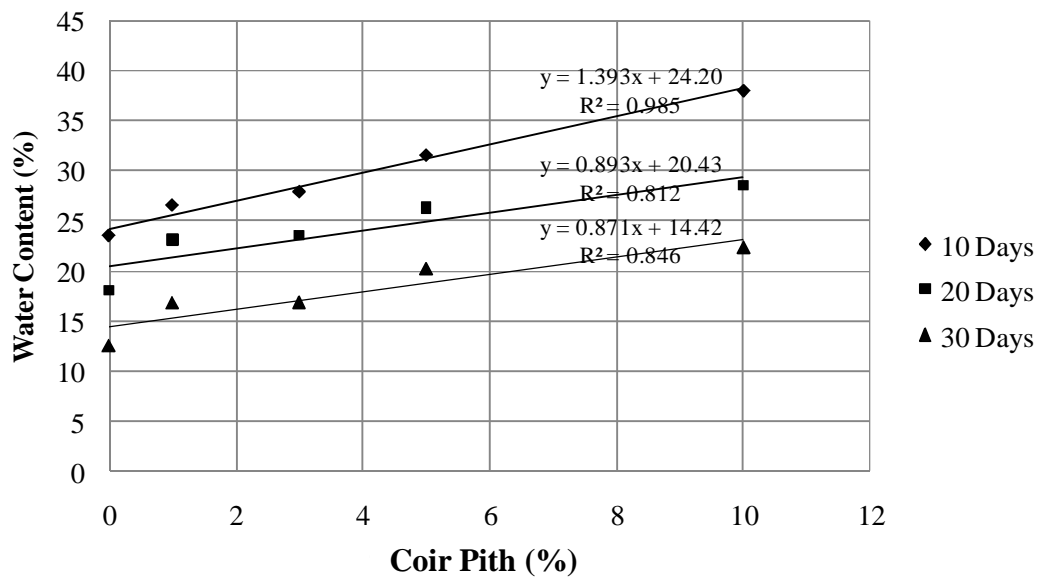
This is far higher than the normally allowable limits and has to be brought down as suggested Krishnamoorthi et. al (1991) . Hence coir pith compost (CC) which can exhibit the higher water holding capacity of CP along with a low C:N ratio because of the manure content, can yield better results from the point of view of plant growth. Hence investigations were carried out on the behaviour of all the four soils on treatment with coir pith compost .

Fig. 5.10 gives the relation between water content vs time for soil S1 treated with CC. Field capacity increase from 20.25% to 42.77% which shows an improvement more than 100%. The PAW improves from 11.11% to 23.75% on addition of 10% CC which is almost double the original value.

For Soil S2, the field capacity improved from 39.84% to 67.94% and the PAW from 19.59% to 34.03%. Similarly for Soil S3 and S4, both the field capacity and PAW register an increase by slightly over 100%.



**Fig. 5.8 Percentage of Coir Pith Vs Water Content for S3 after 10, 20 and 30 days.**



**Fig. 5.9 Percentage of Coir Pith Vs Water Content for S4 after 10, 20 and 30 days.**



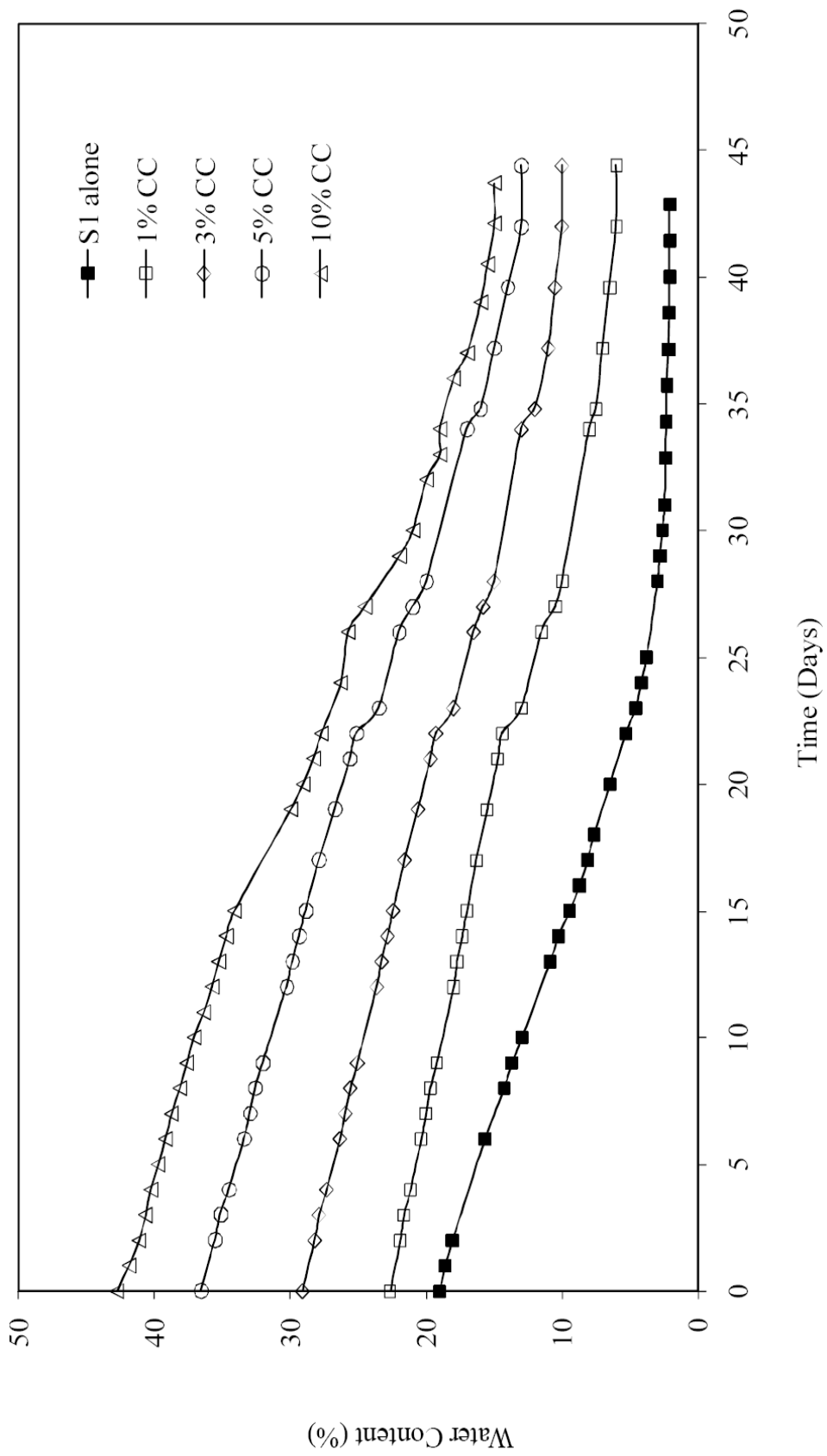
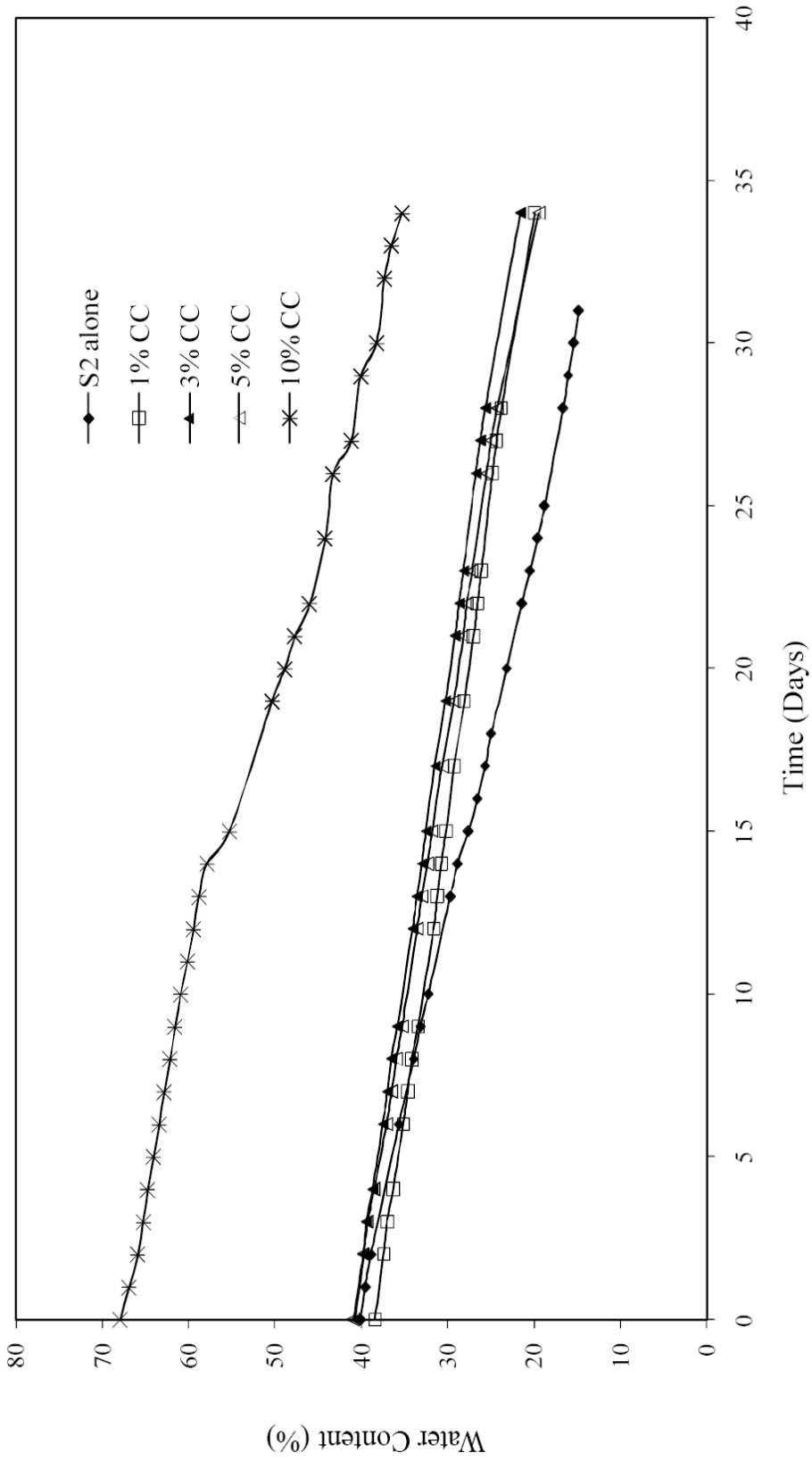


Fig. 5.10 Variation of Water Content with Time for S1 Mixed with CC



**Fig. 5.11** Variation of Water Content with Time for S2 Mixed with CC

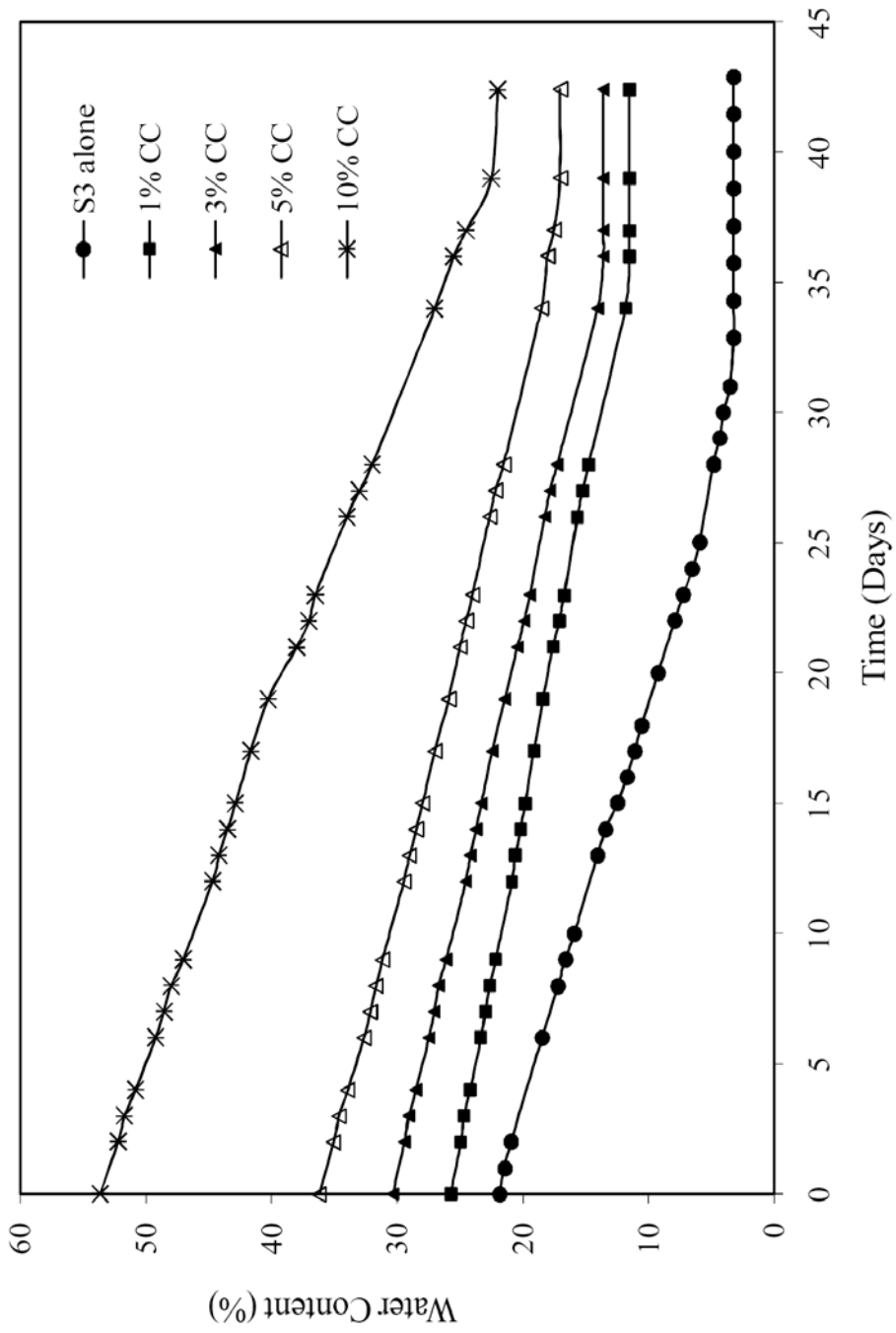


Fig. 5.12 Variation of Water Content with Time for S3 Mixed with CC

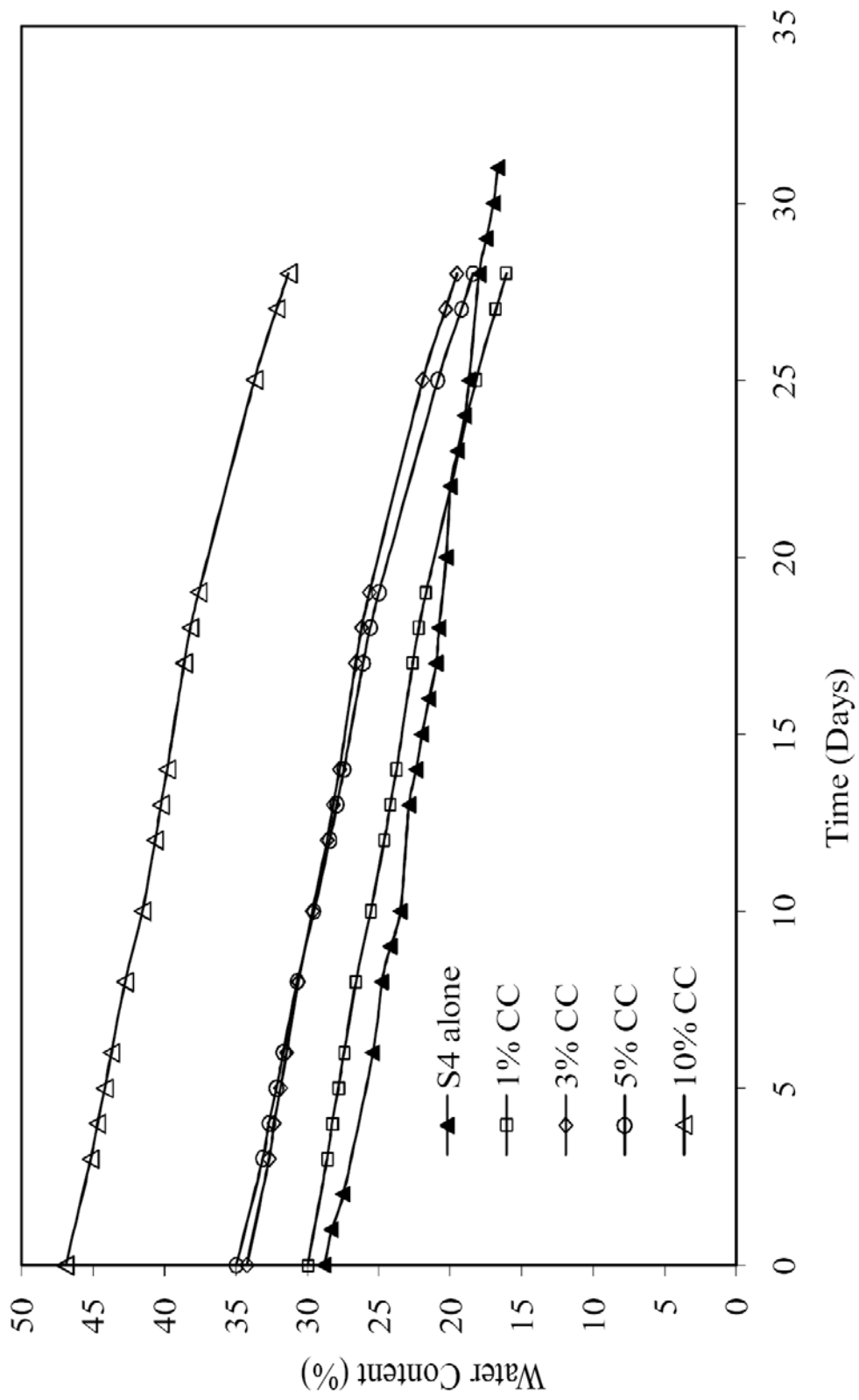
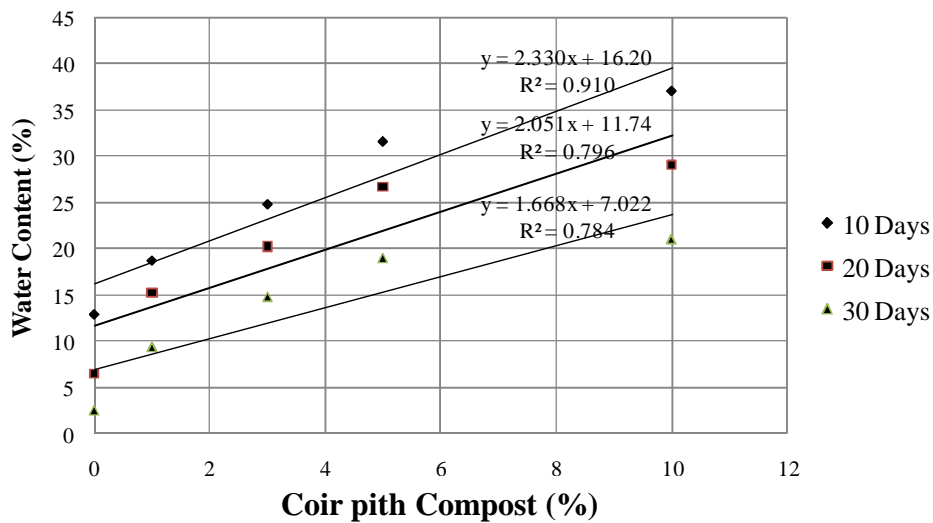


Fig. 5.13 Variation of Water Content with Time for S4 Mixed with CC

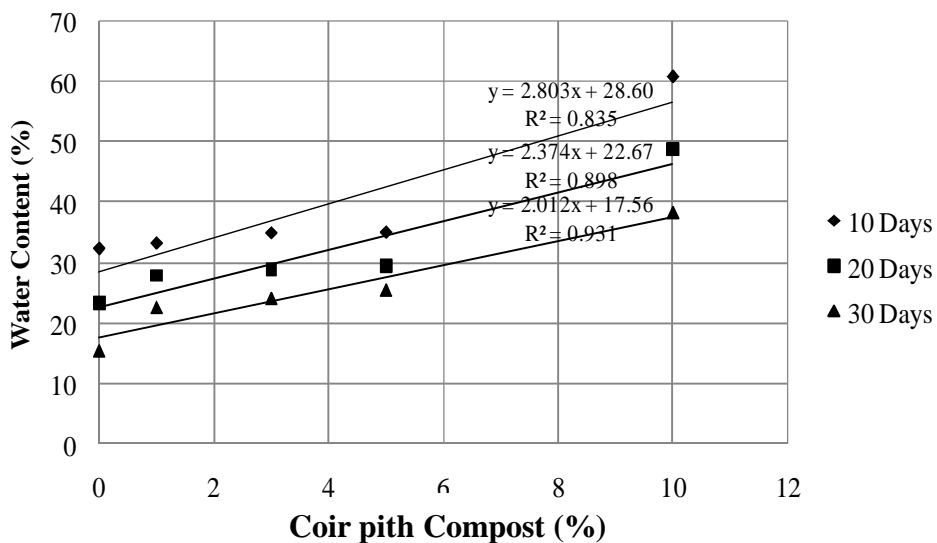
### 5.3.4. Effect of Coir pith Compost (CC) on Irrigation Intervals

The relationship between water content and percentage of CC for irrigation intervals of 10, 20 and 30 days are shown by Fig. 5.14 to 5.17. These relations can help to determine the percentage of CC required to maintain prescribed minimum water contents and the corresponding irrigation intervals.

Fig.5.14 gives such relations of soil S1. From the graph for a minimum water content of 20% and duration of 10 days, the coir pith compost required is nearly 1.8% and for duration of 20 days it is 4.2% and for 30 days it is 8%



**Fig. 5.14 Percentage of Coir pith Compost Vs Water Content for S1 after 10, 20 and 30 days.**



**Fig. 5.15 Percentage of Coir pith Compost Vs Water Content for S2 after 10, 20 and 30 days.**

From the water content vs percentage CC curve, the linear equation obtain after 10 days,20 days and 30 days evaporation with varying percentages of CC for soil S1 are

$$w = 2.330 \text{ CC} + 16.20 \text{ with } R = 0.954$$

$$w = 2.015 \text{ CC} + 11.74 \text{ with } R = 0.892$$

$$w = 1.668 \text{ CC} + 7.022 \text{ with } R = 0.885 \text{ respectively}$$

where,

w= water content

CC= percentage of coir pith compost.

Figures.5.15, 5.16 and 5.17 also give relation between water content and percentage of CC for irrigation intervals of 10, 20 and 30 days for soils S2,S3 and S4.

For soil S2

$$w = 2.803 \text{ CC} + 28.60 \text{ with } R = 0.914$$

$$w = 2.374 \text{ CC} + 22.67 \text{ with } R = 0.948$$

$$w = 2.012 \text{ CC} + 17.56 \text{ with } R = 0.965$$

For soil S3

$$w = 2.909 \text{ CC} + 17.01 \text{ with } R = 0.995$$

$$w = 2.736 \text{ CC} + 12.01 \text{ with } R = 0.981$$

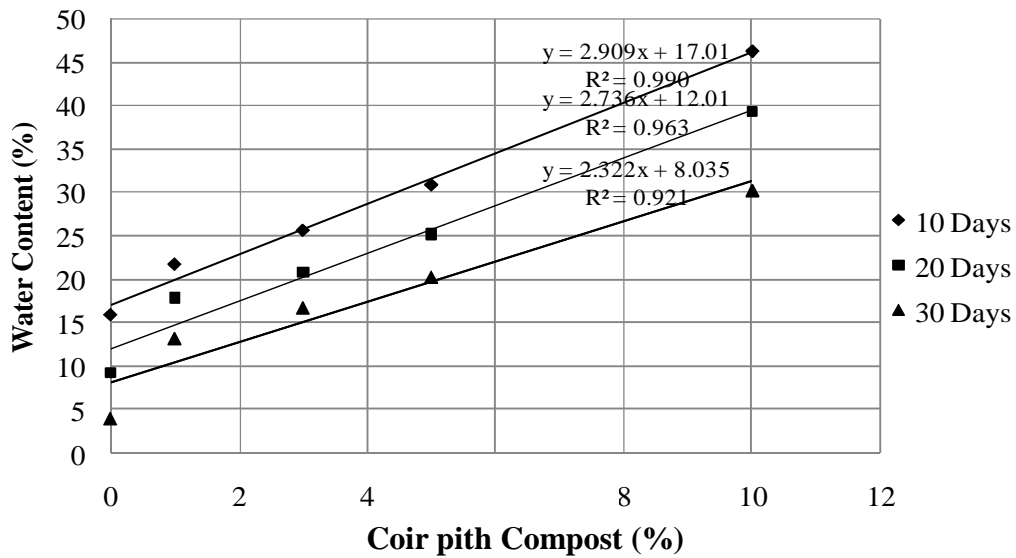
$$w = 2.322 \text{ CC} + 8.035 \text{ with } R = 0.960$$

For soil S4

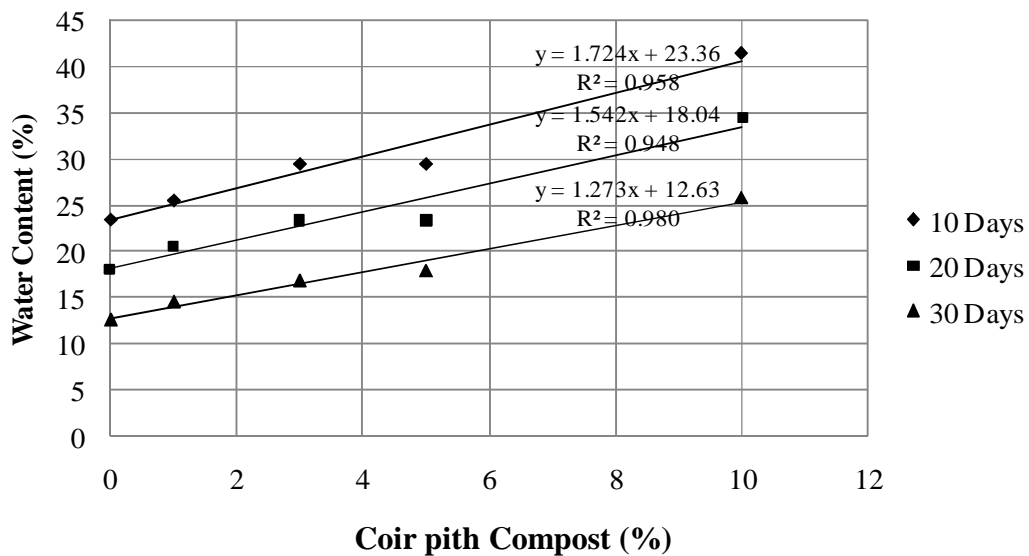
$$w = 1.724 \text{ CC} + 23.36 \text{ with } R = 0.979$$

$$w = 1.542 \text{ CC} + 18.04 \text{ with } R = 0.974$$

$w = 1.273 \text{ CC} + 12.63 \text{ with } R = 0.990$  respectively are the equations obtained after 10, 20 and 30 days of evaporation.



**Fig 5.16 Percentage of Coir pith Compost Vs Water Content for S3 after 10, 20 and 30 days.**



**Fig. 5.17 Percentage of Coir pith Compost vs Water Content for S4 after 10, 20 and 30 days.**

### 5.3.5. Studies on Soil Treated Vermi Compost (VC)

Vermi compost was the third admixture added to the soil to find out whether the water holding capacity can be improved. Unlike the previous two admixtures vermi compost is rich in humus. Mucus like substance coated on each particle increases the aeration as well as drainage in soils. It has the highest manure value among the three admixtures used in the studies.

Compared to C:N ratio of 112:1 of CP and 24:1 of CC vermi compost has a C:N ratio of 14:1. This is biodegradable and is added to soil as a nutrient than as a water holding agent. However when such fertilizers are added to soil their impact on the water holding capacity should be investigate.

Fig.5.18 shows the variation of water content with time for soil S1. When 10% of vermin compost was added the field capacity improved from 20.25% to 28.05% and PAW from 11.1% to 15.3% . The improvements in water holding capacity is not significant.

In case of soils S2, S3 and S4, Figures 5.19, 5.20 and 5.21, the improvements are marginal and erratic. However the experimental results could prove that the water holding capacity does not come down on addition of manures like vermi compost. As improvement in water holding capacity is not significant irrigation intervals can be taken as that of untreated soils.

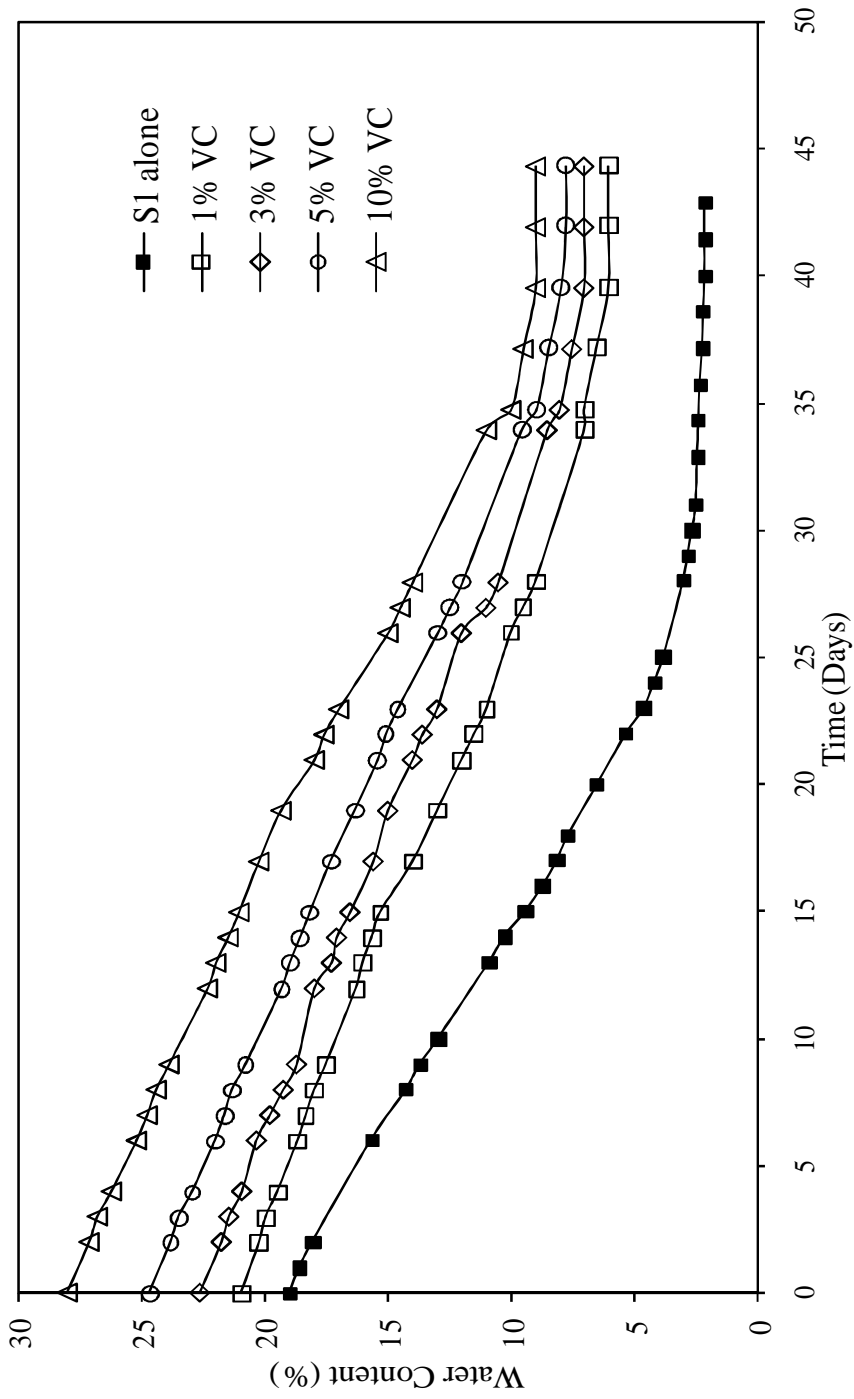
### **5.3.6. Comparitive Study of the Soils when Treated with Different Admixtures.**

Water supplied to the soils is lost from the soil through evaporation and transpiration from plant which is controlled by temperature, wind and humidity. The nature of evaporation has been studied and presented in Figures 5. 22 to 5.25 for all the four soils.

The evaporation loss with time at room temperature for soils S1 and S1 treated with 10% of coir pith, coir pith compost and vermi compost are presented in Fig. 5.22. All the four curves show identical characteristics. For the initial 3 to 5 days the loss is most significant. The rate of loss gets reduced with time and after 10 to 12 days the rate of evaporation loss is negligible.

Fig.5.23 presents the actual variation of evaporation with time for soil S2 with 10% of CP, CC and VC. Figures 5.24 and 5.25 present the above variations for soils S3 and S4 respectively. The nature of the curves are akin to one another. From all the four figures, we can see that the evaporation loss was maximum for coir pith compost, followed by coir pith and vermin compost. This may be due to the volume reduction of coir pith compost due to lower C:N ratio compared to coir pith.





**Fig. 5.18** Variation of Water Content with Time for S1 Mixed with VC

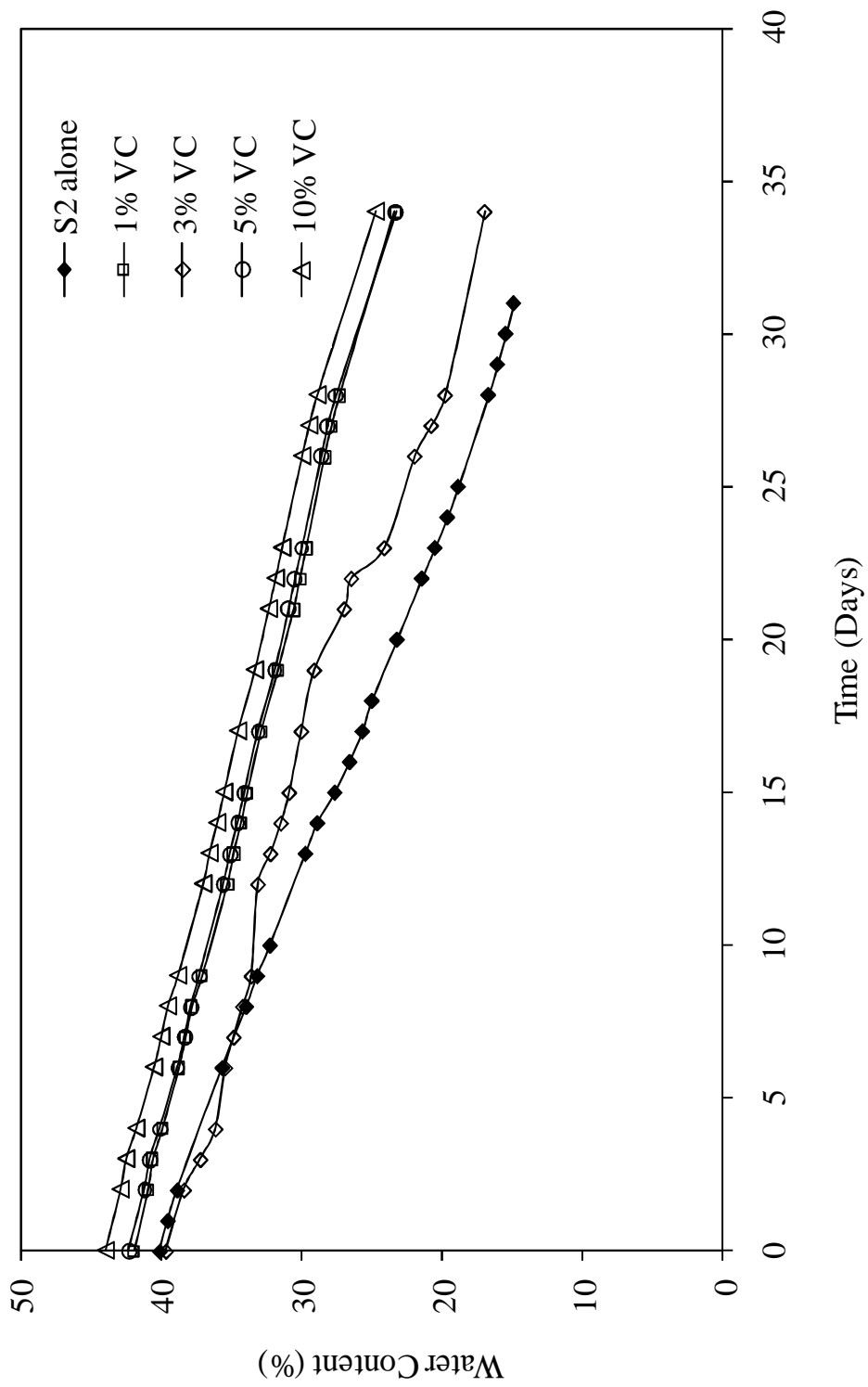


Fig. 5.19 Variation of Water Content with Time for S2 Mixed with VC

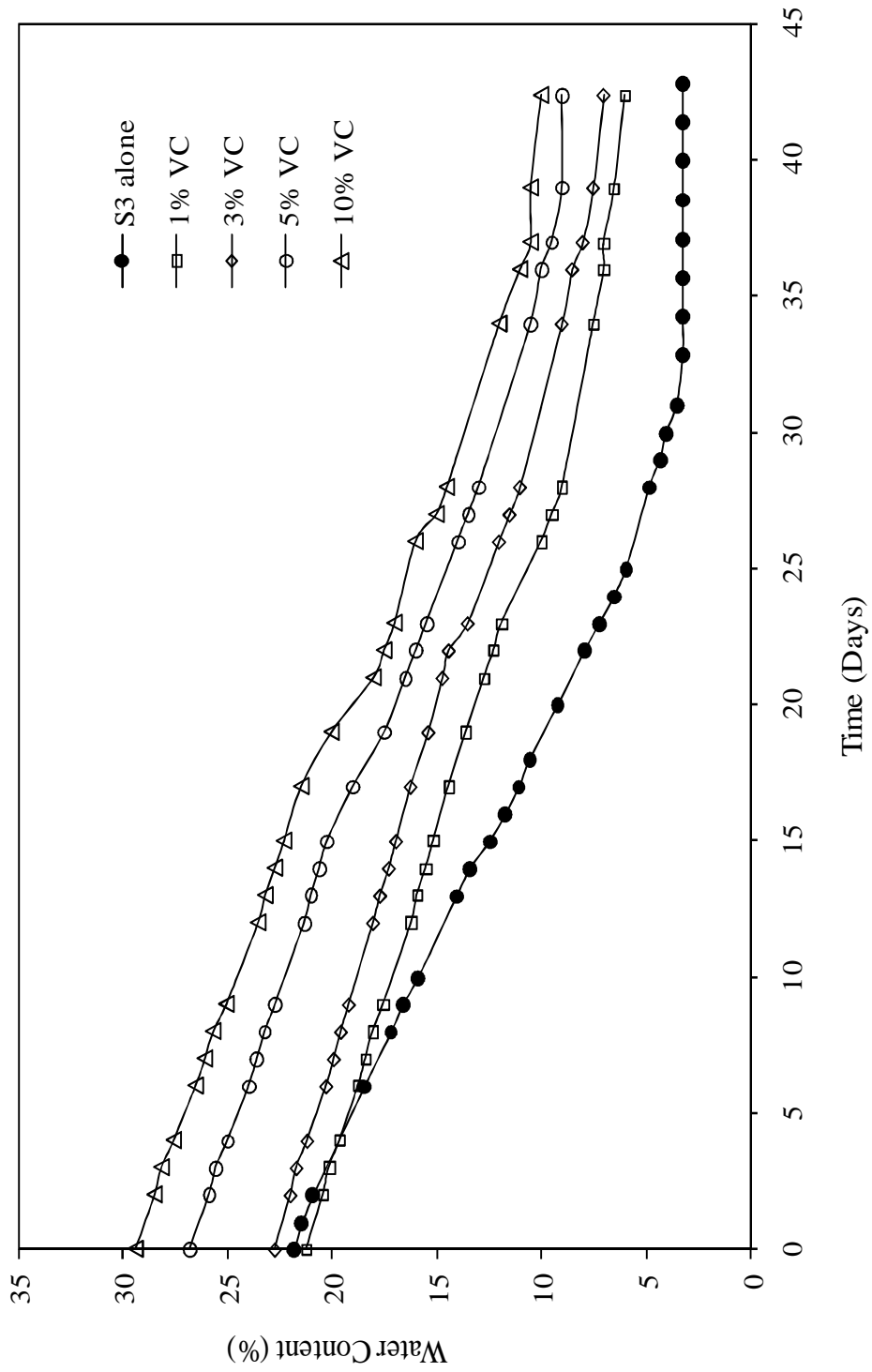


Fig. 5.20 Variation of Water Content with Time for S3 Mixed with VC

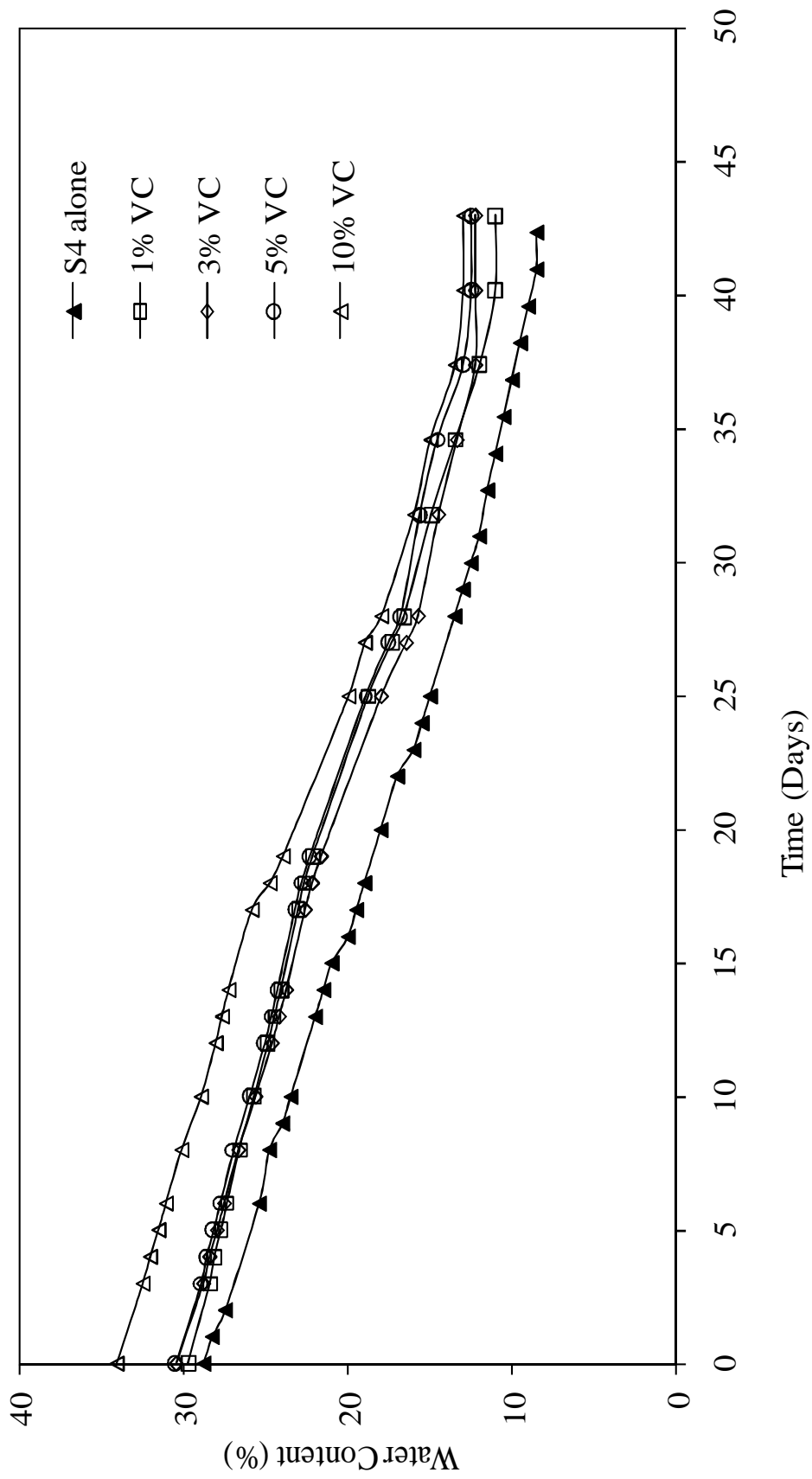


Fig. 5.21 Variation of Water Content with Time for S4 Mixed with VC

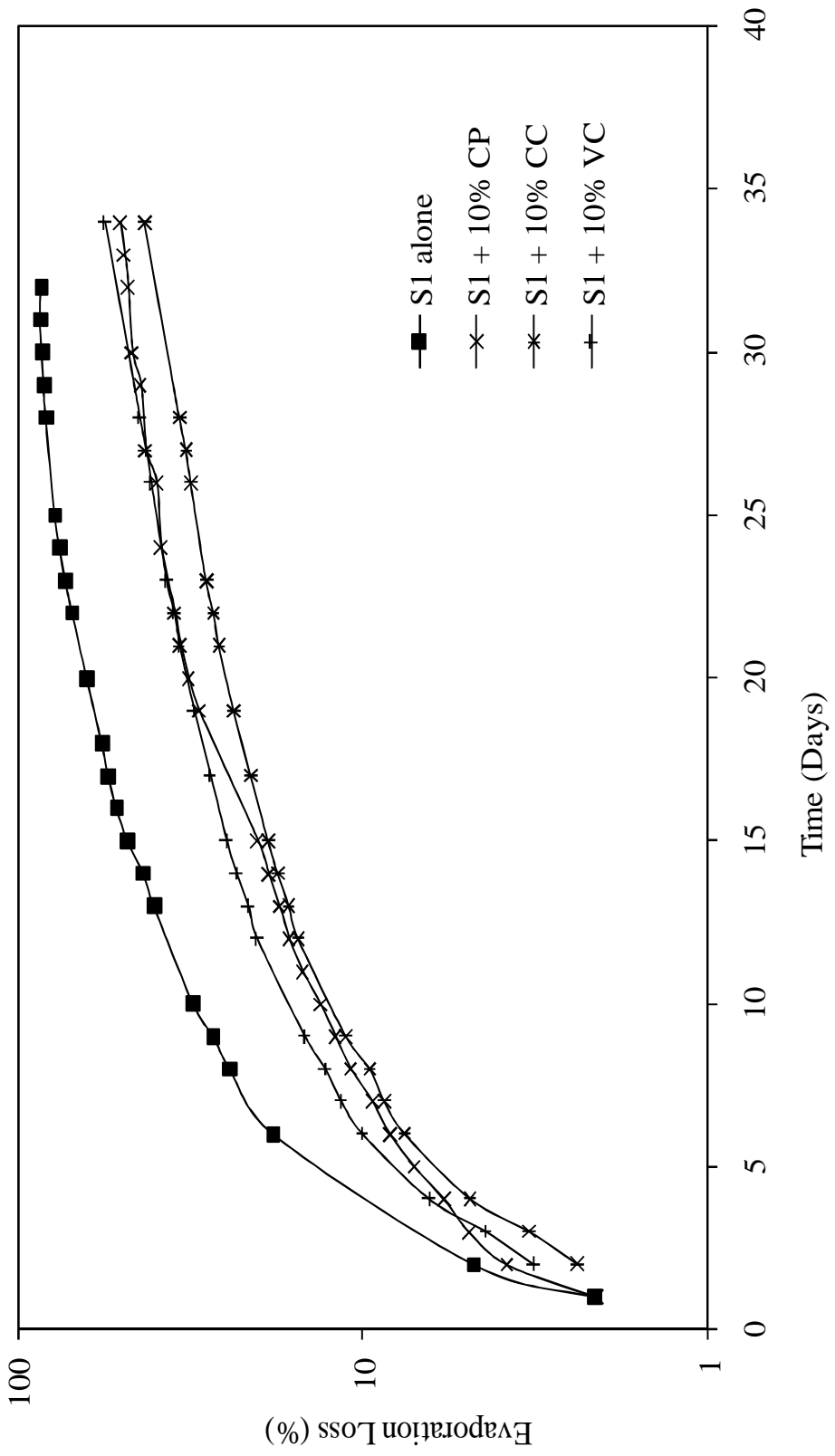


Fig 5.22 Variation of Evaporation Loss with Time for S1

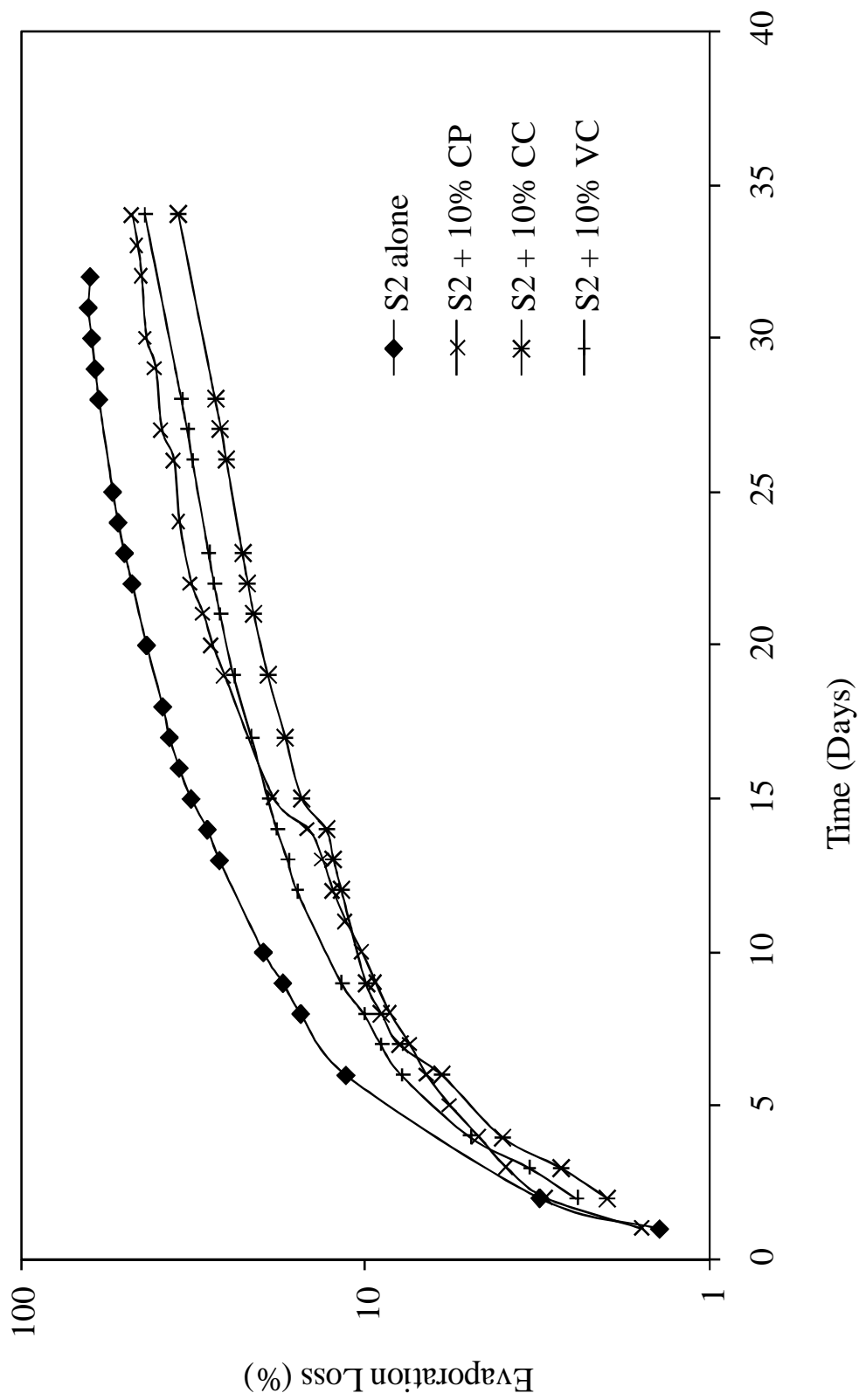
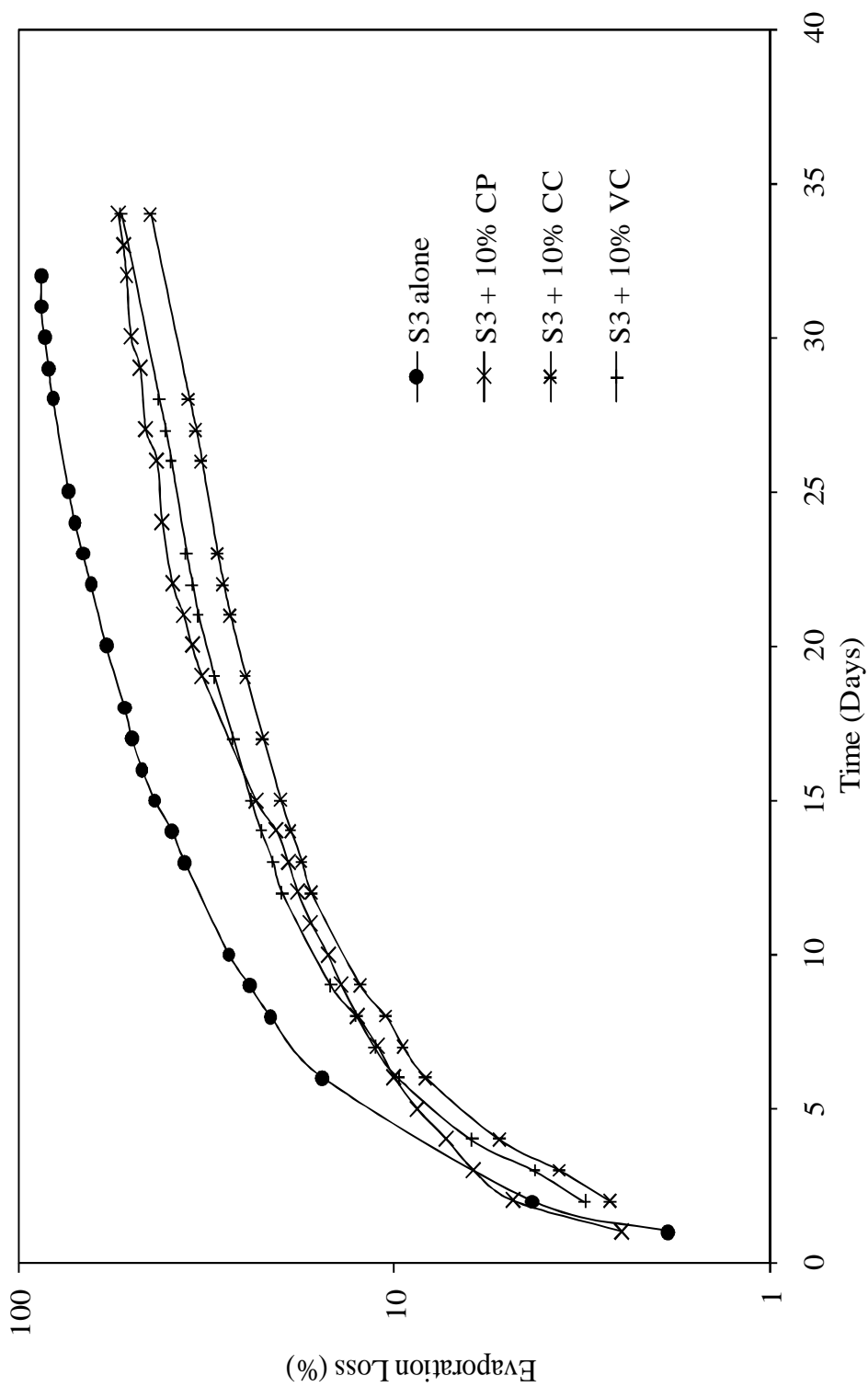
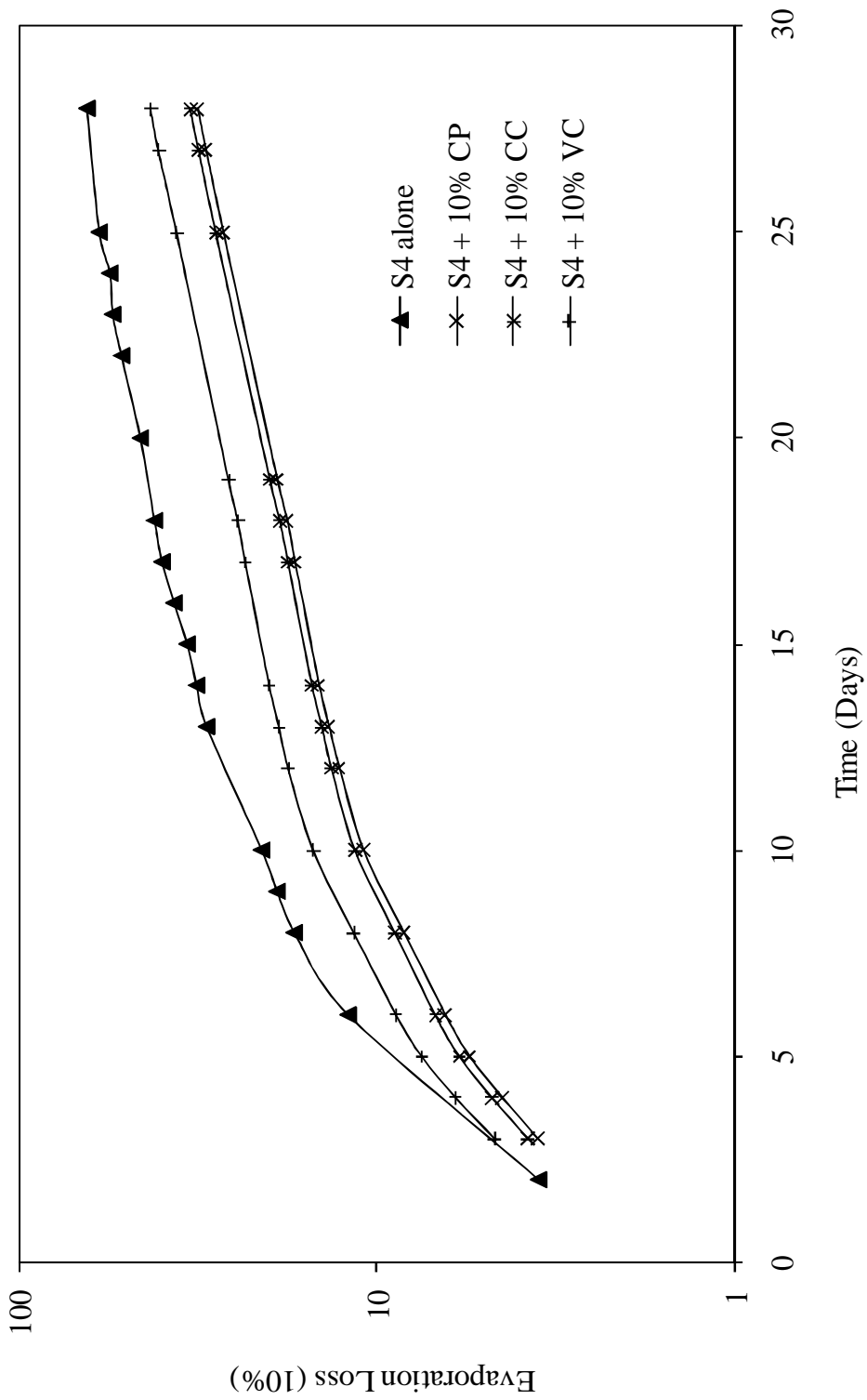


Fig. 5.23 Variation of Evaporation Loss with Time for S2



**Fig. 5.24 Variation of Evaporation Loss with Time for S3**



**Fig. 5.25** Variation of Evaporation Loss with Time for S4



From the above graphs plotted and from Table.5.3. it can be seen that immediately after incorporation the water retention of the soil amended with coir pith was higher than in the control for all the soils whereas incorporation of coir pith compost produced a contrasting effect, which might be due to the variability in the response within treatments. Water holding capacity of coir pith added soil is higher compared to coir pith compost and vermi compost added soils. It might be due to the high water holding capacity of coir pith but the increase is comparatively low compared to its own water holding capacity. It is seen that there is a significant reduction in evaporation when the soils are treated with admixtures and the maximum reduction was found to be for soil treated with coir pith compost followed by coir pith and vermi compost. The incorporation of fresh organic matter modifies the soil functional properties. When incorporated into the soil, organic matter undergoes microbe-induced changes, driven by soil structural and micro-environmental factors.

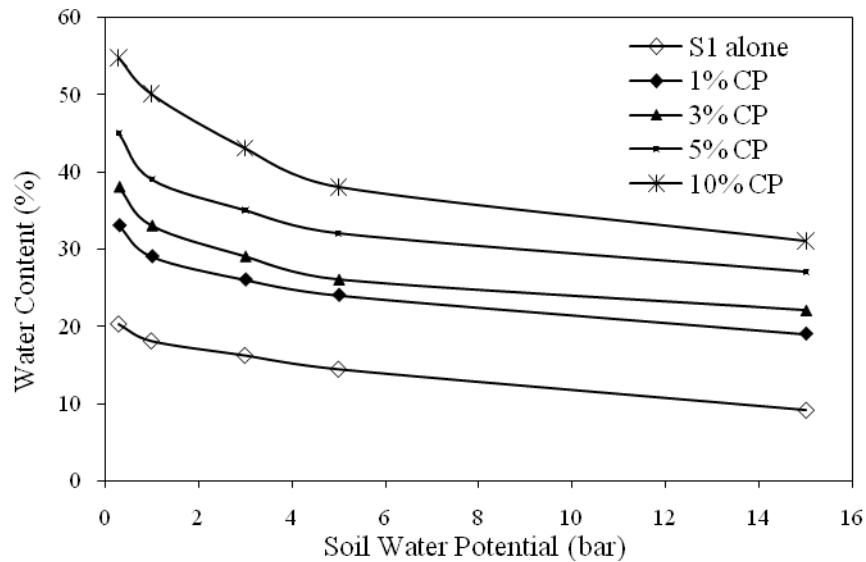
#### **5.4. Effects of Admixture on Soil Moisture Tension**

The moisture content of the soil corresponding to a particular tension is influenced by soil texture, structure, soil solution and temperature. Therefore, soil moisture characteristic curves which give the relationship between the moisture content and the tension for different kinds of soils should be prepared for further use. The soil water retention curves – SWRC - for the four soils and soils added with coir pith, coir pith and vermi compost, determined by pressure plate apparatus by the method prescribed in clause 3.3.2 are shown in Fig. 5. 26 to Fig. 5.27. The variability in the magnitudes of moisture contents at any given tension reflects the variability in soil structure and porosity. In the present study, shapes of the retention curves were found to be almost identical for all as observed by Fredlund et al (1998).

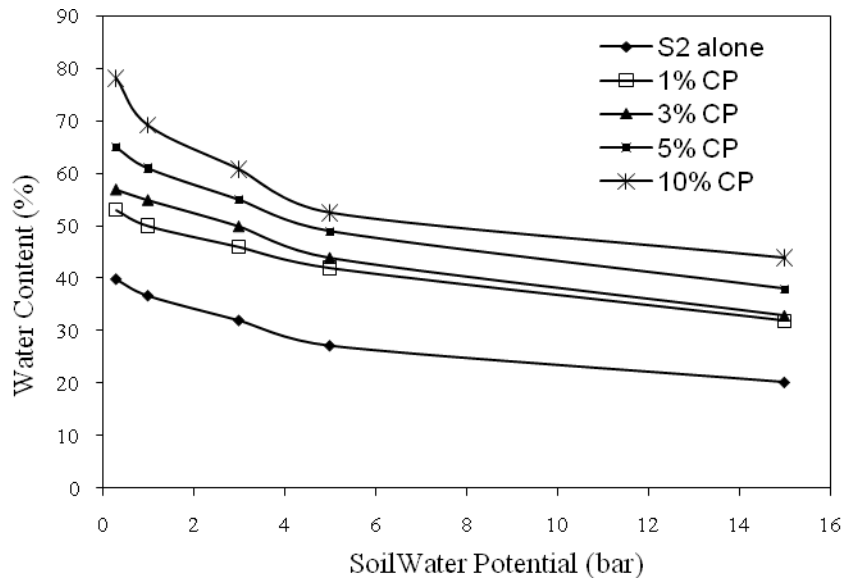
##### **5.4.1 Effect of Coir Pith on Soil Moisture Tension**

The Fig. 5.26 shows the soil water retention curve of soil S1 mixed with coir pith. With no coir pith the maximum water content is 20.25% at 0.33 bar (field capacity). At 5 bar it is 15% and at 15 bar it is 9.15%, as measured by pressure plate apparatus. The variation in water content when the water potential is increased from 5 to 15 bar is not significant. The water content for a water potential of 15 bar is

9.15%. Since plants will not be in a position to draw water below this water content, they start wilting thereafter. Therefore the permanent wilting point (PWP) can be taken as 9.5%. The water that the plant can make use of is the available water content that is the difference in water contents between field capacity and permanent wilting point. Plant available water (PAW) for untreated soil S1 is 11.1%.



**Fig 5.26 SWRC for S1 Mixed with CP**



**Fig 5.27 SWRC for S2 Mixed with CP**

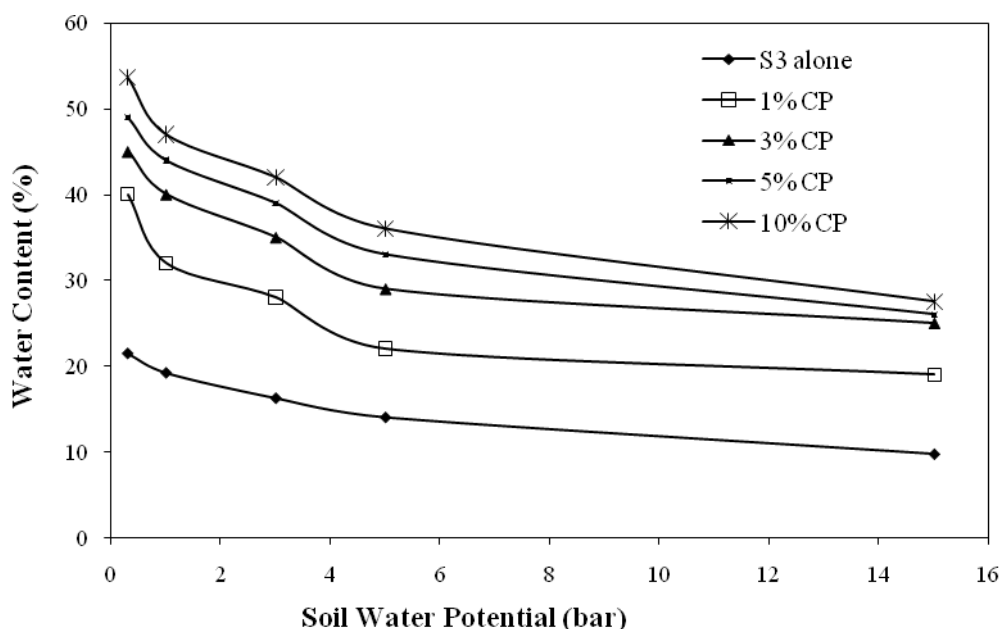
When 10% of coir pith is added to soil S1 the field capacity improves significantly to 54.7%. However while the water content for untreated soil was

9.15%, the water content when a water potential of 15 bar was applied to treated soil is 24.87%. Thus when the soil was treated with coir pith the permanent wilting point also increases from 9.15% to 24.87%. The plant available water in this case is 29.84%.

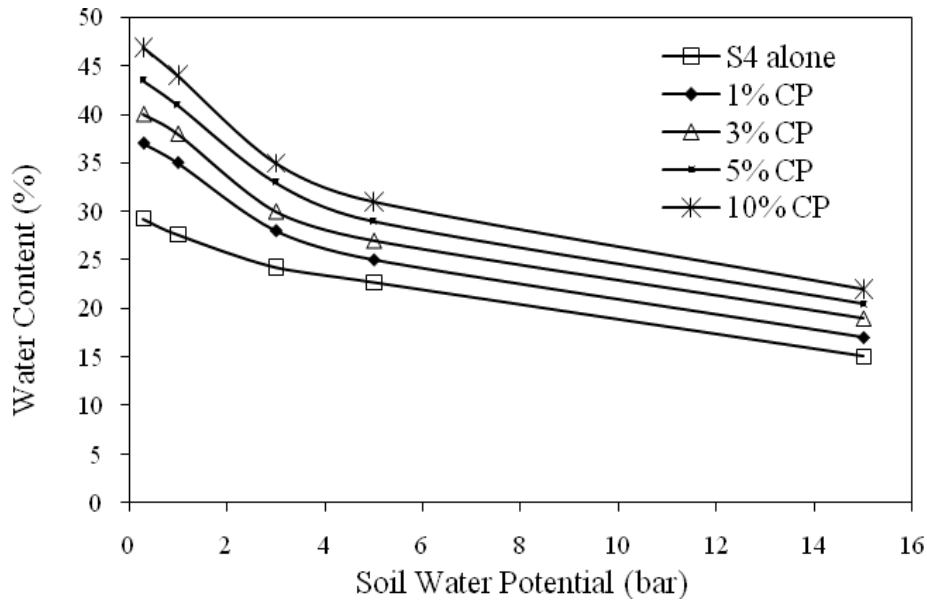
When 10% of coir pith is added the field capacity increases from 20.25% to 54.71% (increase of 170%, in Table 5.3) and plant available water increases from 11.1% to 29.84 (increase of 168%).

Fig. 5.27 shows the soil water retention curve for soil S2 treated with coir pith. For soil S2 the water content at 0.33 bar (FC) is 39.84%, and that for 15 bar (PWP) is 20.25%. The plant available water is 19.59%. When 10% coir pith is added field capacity increases to 79.19% which makes an increase of 96%. The plant available water increases from 19.59% to 42.65% that is by 117%.

Fig. 5.28 shows the soil water retention curve for soil S3 treated with coir pith, which is more sandy in nature. On addition of 10% coir pith, field capacity increases from 21.42% to 53.62% (increase of 150%). Plant available water increases from 11.64% to 29.25% (increase of 151%).



**Fig 5.28 SWRC for S3 Mixed with CP**



**Fig 5.29 SWRC for S4 Mixed with CP**

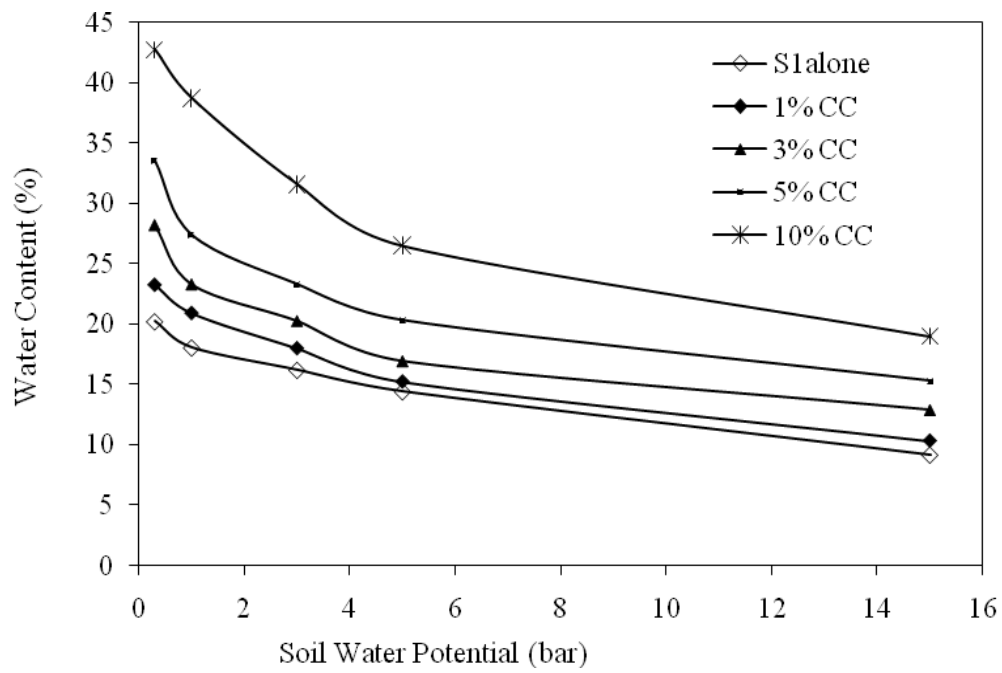
Fig. 5.29 shows the soil water retention curve for soil S4 treated with coir pith. For soil S4 on addition of 10% coir pith, the field capacity and plant available water improves by 66% and 110% respectively.

**Table 5.3 Increase in FC, PWP, PAW for addition of 10% coir pith**

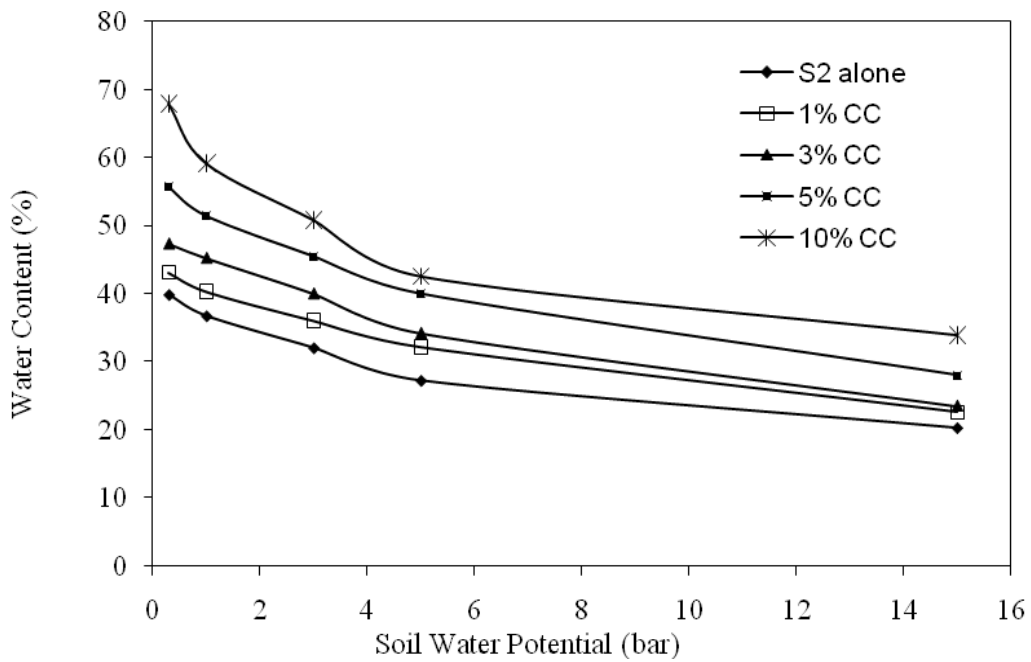
Soil	Fine (%)	FC (%)	PWP (%)	PAW (%)
S1	30	170	171	168
S2	72	96	75.5	117
S3	6	150	149	151
S4	47	66	32	110

The soils S1 and S3 have fines of 30.11% and 6.06% respectively. On treatment with 10% coir pith, the plant available water increases by 168% and 151% over values of 11.1% and 11.64% respectively.

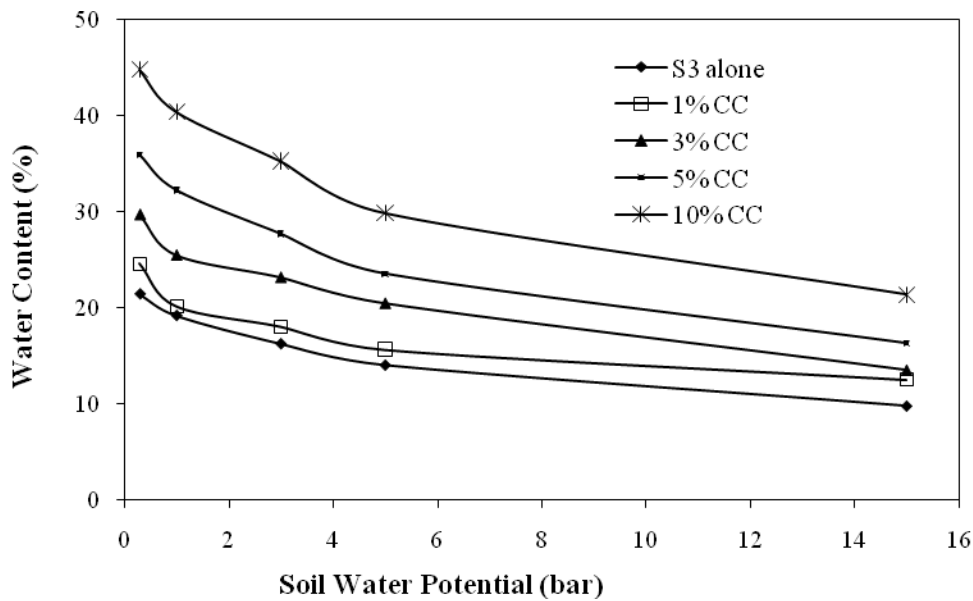
The silt and clay percentage of soil S2 and S4 are 72.45% and 47.92% respectively. The increases in plant available water for the soils on treatment with 10% coir pith are 117% and 110%. A comparison of this result shows that treatment with coir pith is more effective for soils with more sand content.



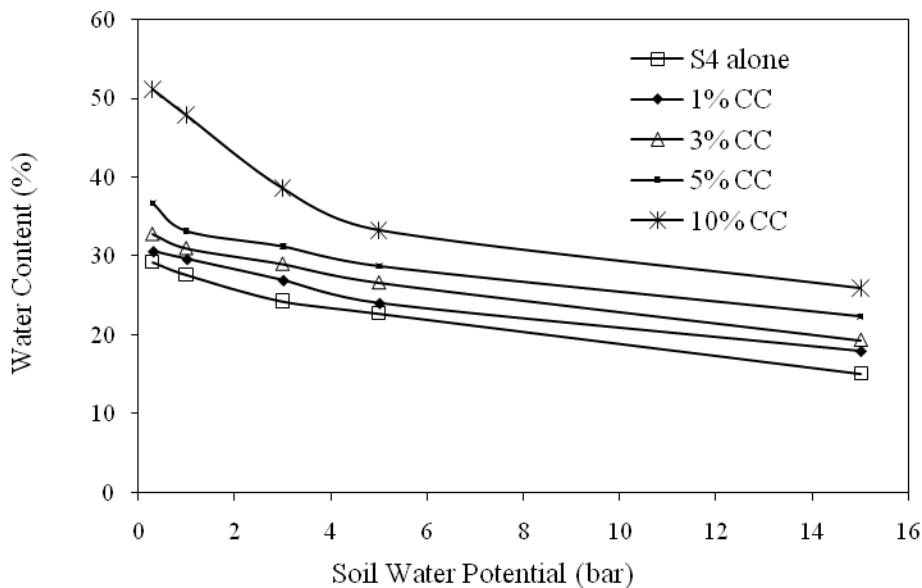
**Fig 5.30 SWRC for S1 Mixed with CC**



**Fig 5.31 SWRC for S2 Mixed with CC**



**Fig 5.32 SWRC for S3 Mixed with CC**



**Fig 5.33 SWRC for S4 Mixed with CC**

#### 5.4.2 Effect of Coir pith Compost on Soil Moisture Tension

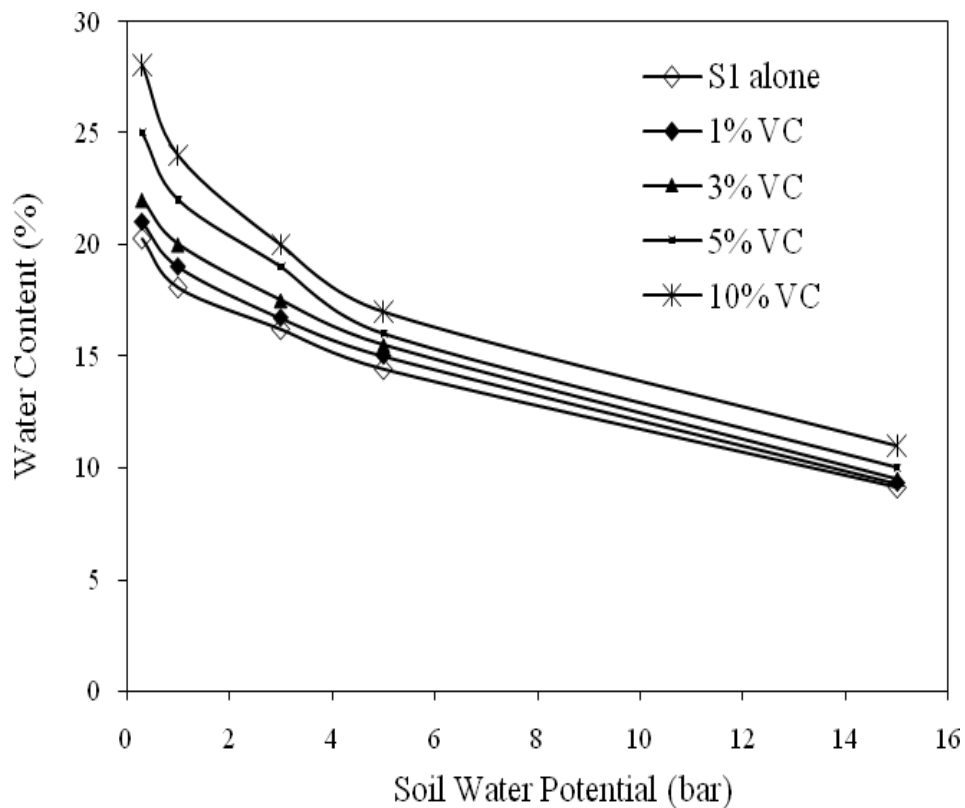
Fig.5.30 to Fig.5.33 show the results of the pressure plate tests conducted on soils S1 to S4 treated with coir pith compost. When soil S1 was treated with 10% CC, the field capacity increased from 20.25% to 42.77% and the plant available water from 11.11% to 23.75%. The corresponding percentage increases are 111% and 168.8% respectively.

The improvements in values of field capacity, permanent wilting point and plant available water for the four soils when treated with 10% of coir pith compost (CC) are given in Table 5.4

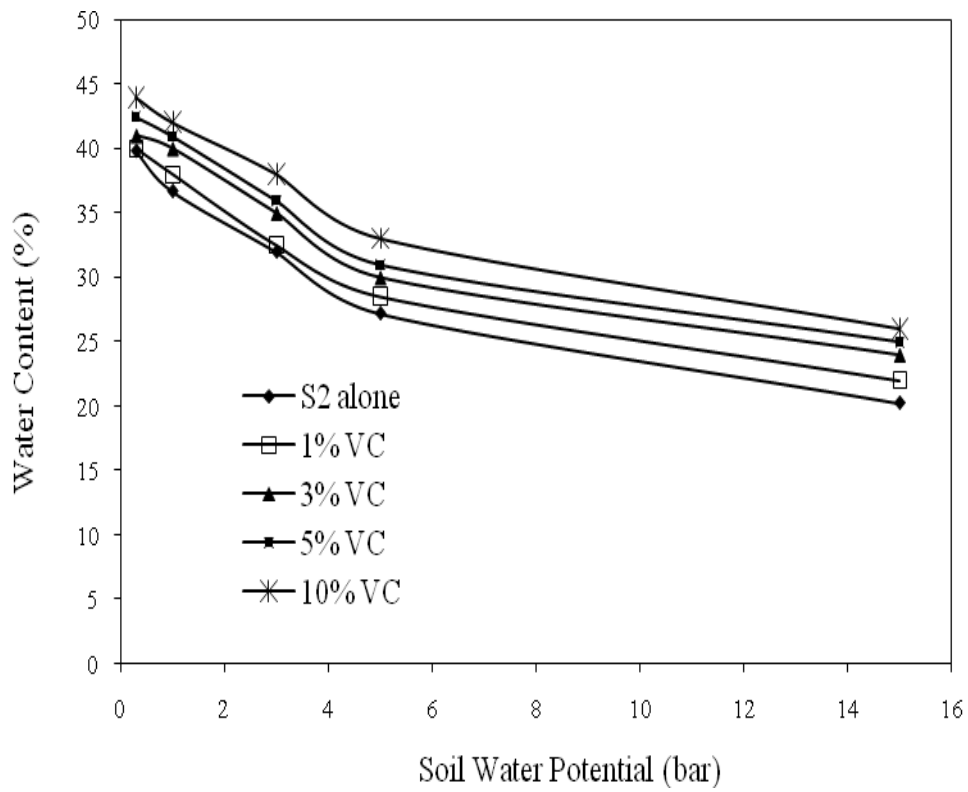
**Table 5.4 Increase in FC, PWP, PAW for addition of 10% coir pith compost**

Soil	Fine (%)	FC (%)	PWP (%)	PAW (%)
S1	30	111	108	168.8
S2	72	70	67.5	73
S3	6	108	118.2	101
S4	47	81	97.6	107

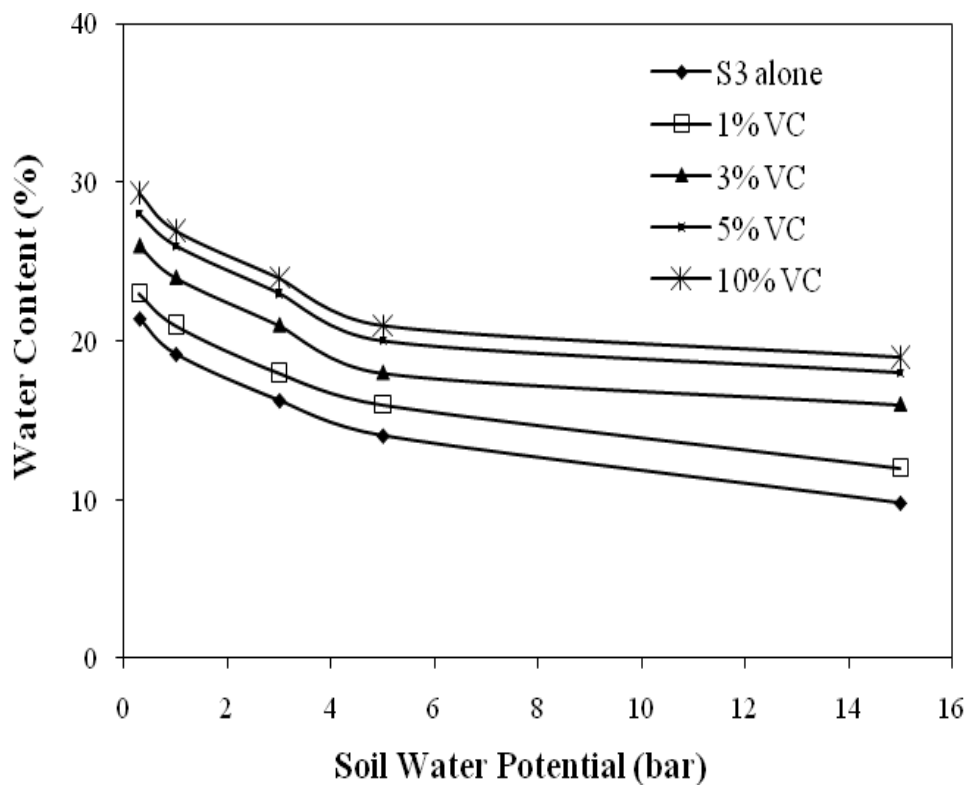
Fig.5.34 to 5.37 present the results of the pressure plate apparatus tests on soils treated with vermi compost, which has more fertiliser value than water retention capabilities.



**Fig 5.34 SWRC for S1 Mixed with VC**

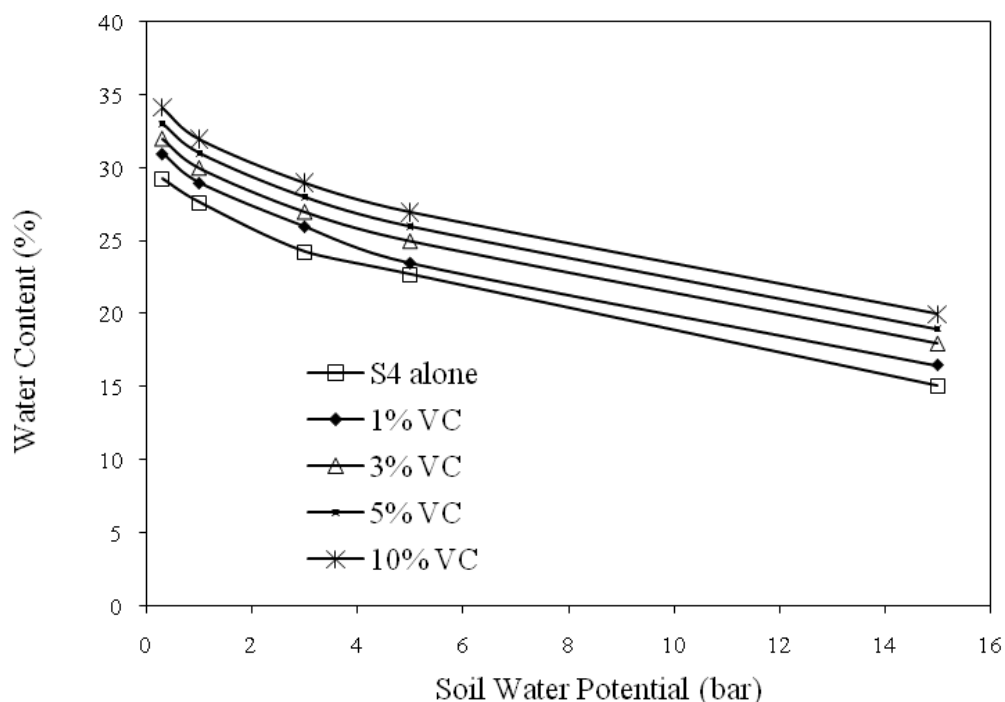


**Fig 5.35 SWRC for S2 Mixed with VC**



**Fig 5.36 SWRC for S3 Mixed with VC**





**Fig 5.37 SWRC for S4 Mixed with VC**

### 5.4.3 Effect of Vermi Compost on Soil Moisture Tension

Table 5.5 presents the improvements in field capacity, permanent wilting point and plant available water for all the four soils when they are treated with 10% vermi compost.

**Table 5.5 Increase in FC, PWP, PAW for addition of 10% vermi compost**

Soil	Fine (%)	FC (%)	PWP (%)	PAW (%)
S1	30	38.5	39.3	37.8
S2	72	10.3	15.0	22.3
S3	6	37.1	36.5	37.62
S4	47	20.9	19.1	24.17

A comparison on the improvement of plant available water for the four soils when they were treated with 10% of coir pith, coir pith compost and vermi compost is presented in Table 5.6.

**Table 5.6 Increase in PAW for the three admixtures**

Soil	Increase in PAW (%) for 10% admixture		
	CP	CC	VC
S1	168	168.8	37.8
S2	117	73	22.3
S3	151	101	37.62
S4	110	107	24.17

Obviously the improvement in plant available water is maximum for coir pith which is in the range of 110 to 168%. From the point of view of water retention for plant growth coir pith is the most acceptable admixture Bandyopadhyay, S.K and Ray, S.K (1988) studies with the incorporation of Jalsakthi with soil shows a maximum improvement of 47% in PAW, here the results are improved by three times.

Coir pith compost can improve the soils in water retention capacity and also the fertility. This also enhances the plant available water by 73 to 168.8%. Considering the dual advantage, coir pith compost can also be equally effective in plant growth.

Vermi compost does not contribute to improvement in plant available water. However the results provide an insight into the water retention capacity of the soil on application of fertilizer.

## **5.5. ELEMENTS REQUIRED IN PLANT NUTRITION**

A mineral element is considered to be essential to plant growth and development if the element is involved in plant metabolic functions and the plant cannot complete its life cycle without the element. Usually the plant exhibits a visual symptom indicating a deficiency in a specific nutrient which normally can be corrected or prevented by supplying that nutrient. Extreme deficiencies can result in plant death. Excessive nutrient concentration can cause an imbalance in other essential nutrients, which also can reduce yield.

Sixteen elements are considered essential to plant growth; the three elements carbon, hydrogen and oxygen are the most abundant in the plants for the

photosynthetic process. The remaining 13 essential elements are classified as macro nutrients and micro nutrients and classification is based on the relative abundance in plants. The macro nutrients are Nitrogen (N), Phosphorus (P), Potassium (K), Calcium (Ca), Magnesium (Mg) and Sulphur (S). Compared to the macro nutrients, the concentration of the 7 micro nutrients-iron(Fe), zinc (Zn), manganese (Mn), copper(Cu), boron(B), chlorine(Cl) and molybdenum(Mo) – are very small. Though micro nutrient efficiency or toxicity can reduce plant growth, similar to macro nutrients efficiency or toxicity, for normal soils the agriculturists generally consider the macro nutrients nitrogen, phosphorus, potassium and calcium.

### **5.5.1 Effect of Varying Percentage of Admixtures on pH Value, Nutrients and Cation Exchange Capacity of Soils.**

Tables 5.7 to 5.9 show the value of pH, organic content, Nitrogen, Phosphorous, Pottasium, Calcium and Cation Exchange Capacity (CEC) of all the four types of soils for increasing percentages of coir pith, coir pith compost and vermi compost. Fig 5.37 to 5.43 show their relation of this with percentages of coir pith. Fig 5.44 to 5.50 for coir pith compost and fig 5.51 to 5.57 for vermi compost.

It is seen that incorporation of these admixtures increases the pH value but increases are marginal. The organic and nutrient contents and cation exchange capacity increased and increases are almost proportional to the percentage of admixtures.

It is seen from the Table 5.10 to 5.12 that 10% addition of each admixture increases the cation exchange capacity significantly. The CEC gives an indication of soils to hold plant nutrients like OC, N, P, K and Ca. Larger the number, more nutrients can be carried. Clay will have large CEC than a sandy soil. Though the amount of organic matter is exceeds in some cases, the amount is critical in most surface soils. It is of prime importance in keeping the soil loose and open and is an essential source of several nutrient elements. The addition and subsequent decay of organic matter in the soil is that highly significant both physically and chemically.

Available nitrogen, potassium, phosphorus and calcium and cation exchange capacity increased with admixture application. The addition of organic matter have increased microbial activity and subsequently increased nitrogen availability. This

indicates that the addition of admixtures considerably helps in the fermentative process.

### **5.5.2. Effect of Addition of Coir Pith on Essential Elements**

Detailed chemical analysis were carried out on samples treated with 1, 3, 5 and 10% of coir pith on the four soils and the results were presented in Table 5.7 for pH, organic content (OC), Nitrogen (N), Potassium (K), Calcium (Ca) and Cation exchange capacity (CEC).

Fig.5.38 shows the variation of pH in the soil on addition of coir pith. The figure shows a linear variation of pH with coir pith. The increase is minimum for soil S1 and maximum for soil S4. The values are within the permissible limits.

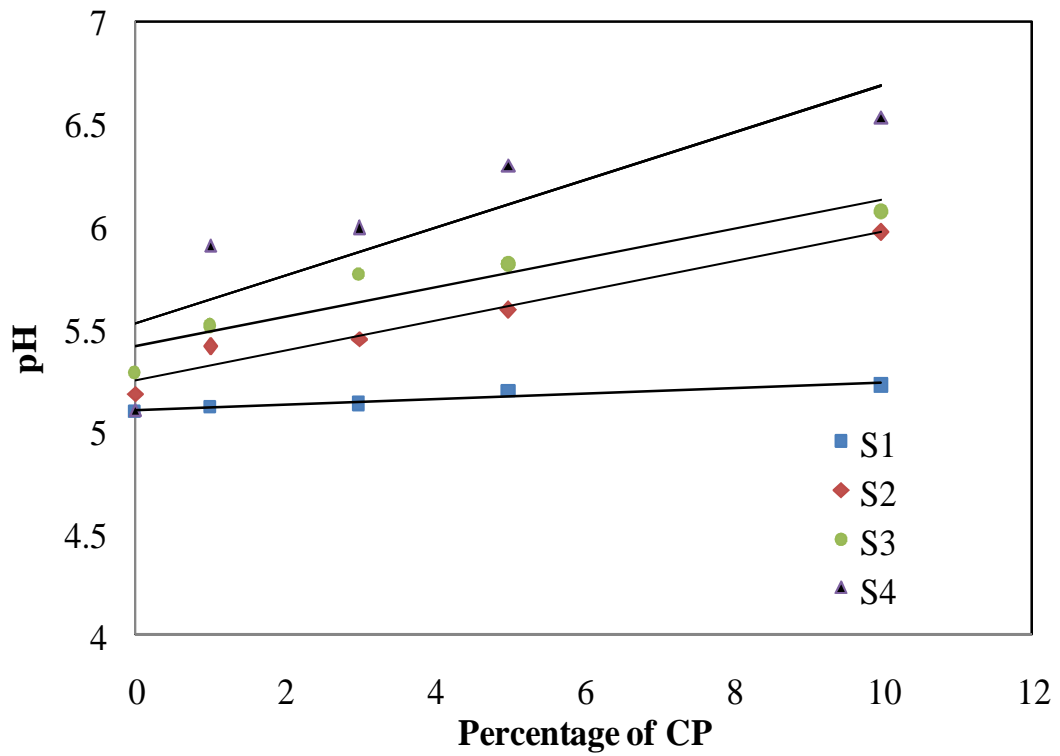
Fig. 5.39 shows the values of organic carbon for the treated soils. The change in organic carbon for soil S3 which is sandy in texture is minimum. Soils S1 and S2 which have fines of 30 % and 72 % respectively show a marginal increase. However soil S2 which has a higher content of fines than the other three soils show a notable increase in organic carbon from 1.38 to 2.49. For percentage of 1, 3 and 5 the organic carbon values are 1.38, 1.41, and 1.45. The increase is sharp on addition of CP to soil from 5% to 10%. Hence where organic carbon has to be kept low, the addition of coir pith may be limited to 5%.

Fig. 5.40 shows the variation of Nitrogen with varying percentage of CP. The variation is linear and similar in all the four cases of soils S1, S2, S3 and S4. The values are higher in case of soil S2 which has greater fines content.

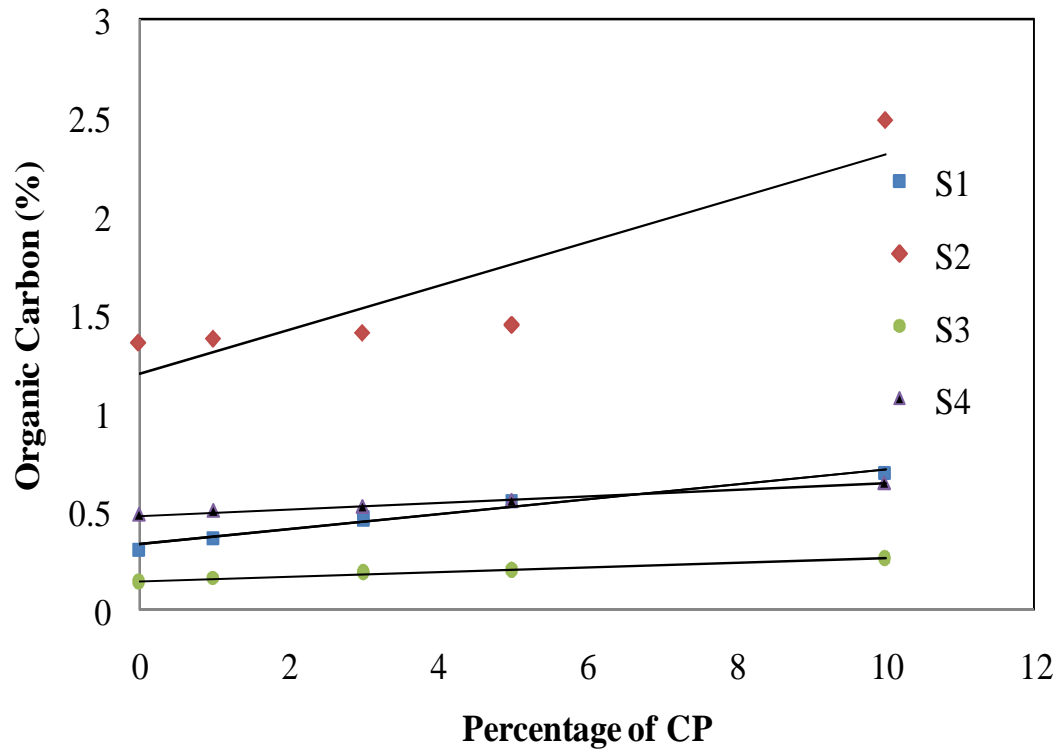
The change in phosphorus in addition of coir pith were shown in Fig.41 The values are negligible for soils S2 and S3 and notable for soils S4 and S1. But the percentage increase is not considerable.

**Table 5.7 Effect of CP on pH value, Nutrients and  
Cation Exchange Capacity of Soils**

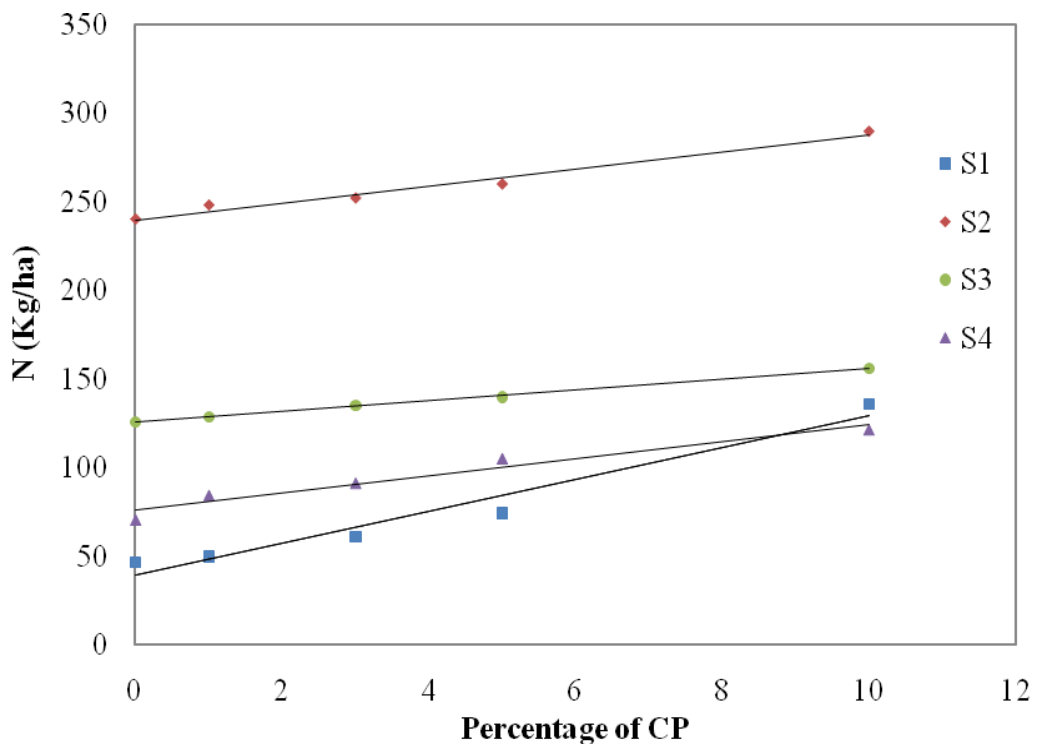
Soil type	pH	OC%	Available N kg/ha	Available P Kg/ha	Available K Kg/ha	Available Ca Kg/ha	Cation Exchange Capacity Cmolkg <sup>-1</sup>
S1	5.09	0.30	46.38	44.38	53.76	666.18	9.96
S1 + 1 % CP	5.11	0.36	49.58	48.58	57.34	706.41	10.50
S1 + 3 % CP	5.13	0.46	60.78	60.33	64.74	906.41	12.30
S1 + 5 % CP	5.19	0.55	74.20	63.98	69.22	1011.38	14.67
S1 + 10% CP	5.22	0.69	135.95	77.20	84.62	1108.90	16.50
S2	5.18	1.36	240	12.36	380.8	1101.18	24.10
S2 + 1 % CP	5.41	1.38	248	12.37	387.52	1103.52	25.23
S2 + 3 % CP	5.45	1.41	252	12.51	427.84	1126.496	27.13
S2 + 5 % CP	5.59	1.45	260	15.01	443.52	1146.21	28.68
S2 + 10 % CP	5.97	2.49	290	18.11	494.33	1166.79	34.88
S3	5.28	0.14	126	8.24	188.16	285.60	3.35
S3 + 1 % CP	5.51	0.16	129	8.241	190.30	408.35	3.59
S3 + 3 % CP	5.76	0.19	135	9.76	195.46	425.32	5.25
S3 + 5 % CP	5.81	0.20	140	10.31	201.6	449.79	6.32
S3 + 10 % CP	6.07	0.26	156	12.57	220.34	462.33	7.91
S4	5.10	0.48	70	131.18	239.68	568.51	16.51
S4 + 1 % CP	5.91	0.50	84	135.1	248.64	605.92	17.10
S4 + 3 % CP	5.99	0.52	91	142.24	271.01	756.48	18.19
S4 + 5 % CP	6.30	0.55	105	143.54	282.21	797.88	19.06
S4 + 10 % CP	6.53	0.64	12 1.45	159.23	299.56	1180.20	21.25



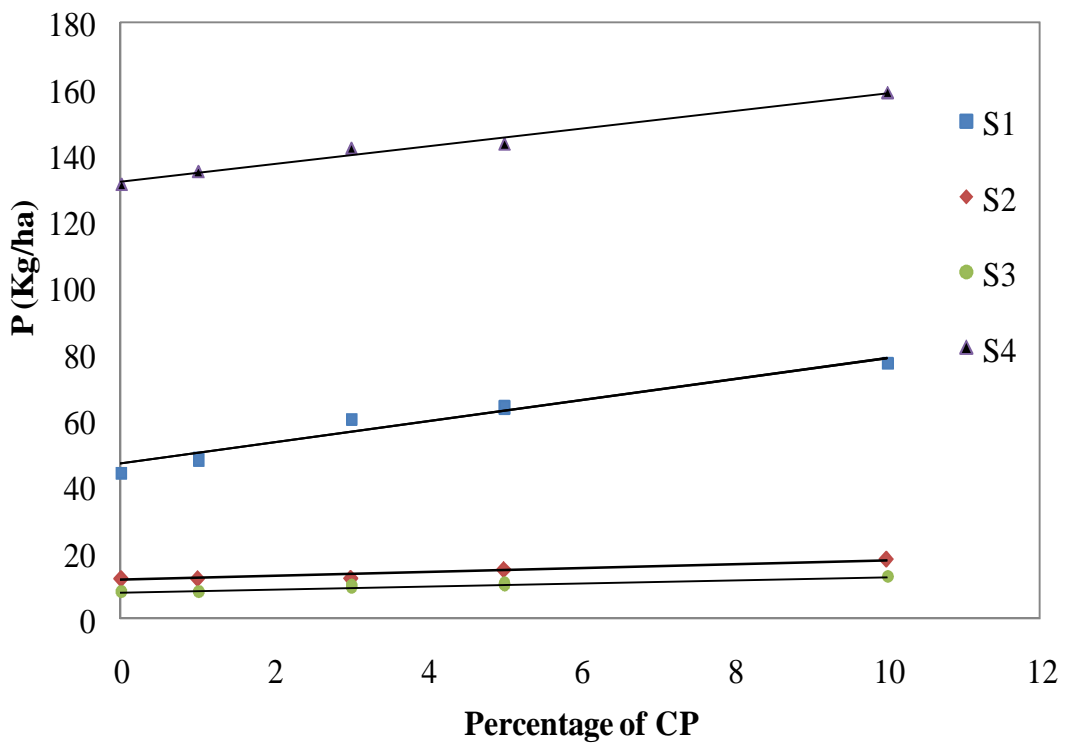
**Fig. 5.38 Effect of Coir Pith on pH**



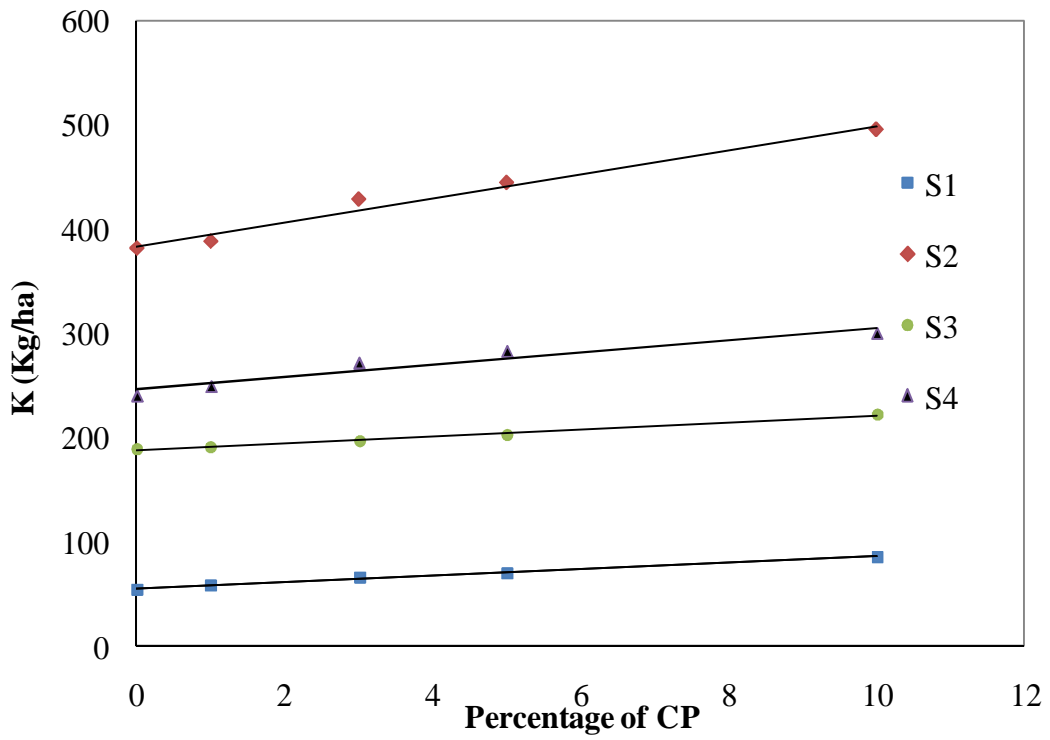
**Fig. 5.39 Effect of Coir Pith on Organic Carbon**



**Fig. 5.40 Effect of Coir Pith on Nitrogen**

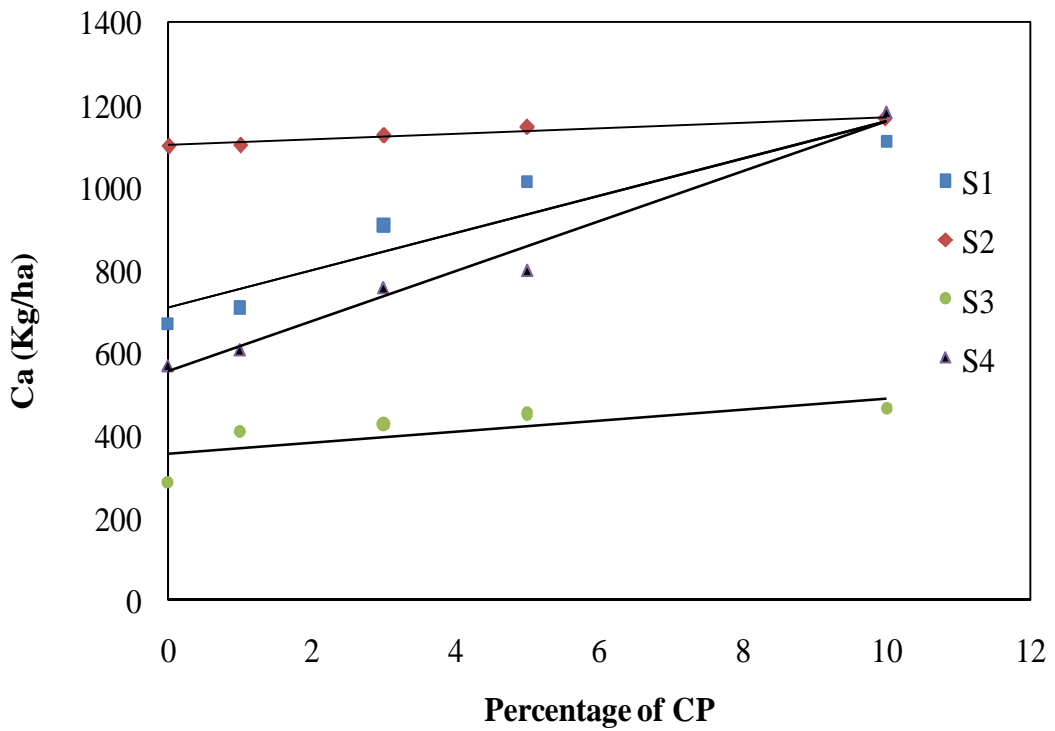


**Fig. 5.41 Effect of Coir Pith on Phosphorous**



**Fig. 5.42 Effect of Coir Pith on Potassium**

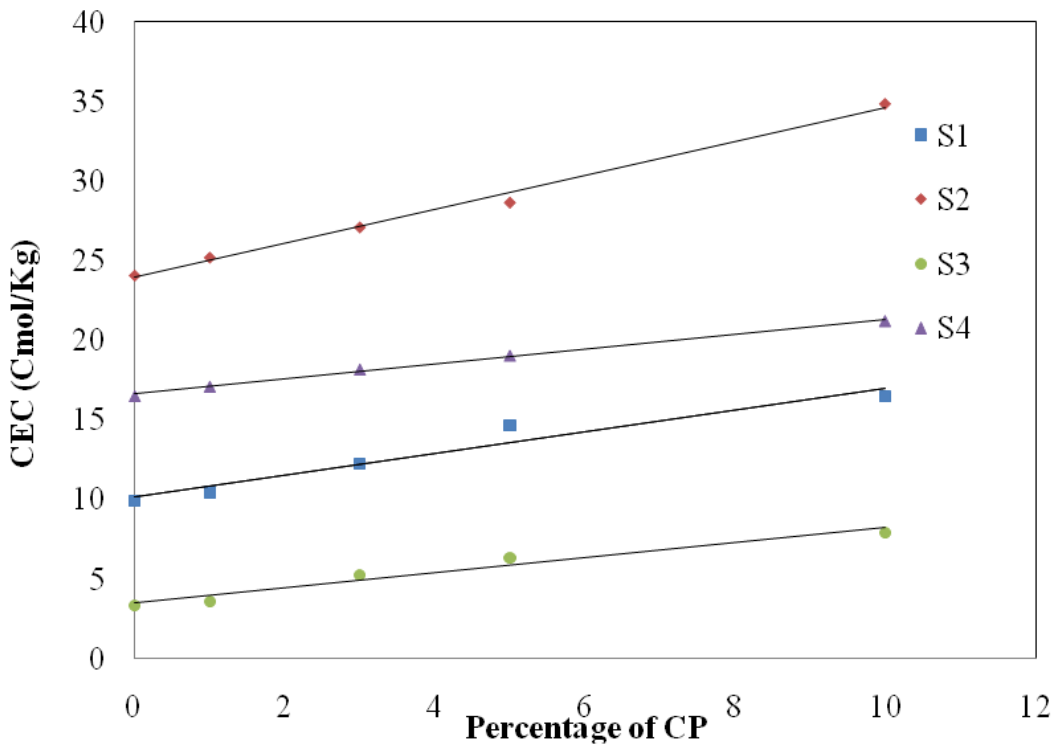
Percentage increase in potassium content when treated with coir pith is not very significant on addition of coir pith as shown by Fig.5.42



**Fig. 5.43 Effect of Coir Pith on Calcium**



The calcium (Ca) content can vary significantly on treatment with coir pith as shown by Fig.5.43. Soils S2 and S3 are not very sensitive to coir pith. But Ca values in soils S1 and S4 increase from 666.18 to 1108.9 and 568.51 to 1180.2 respectively, almost 100% increases. However, the accepted permissible limit (Table 5.11) for a Ca is 3900 kg/hectare and hence safe.



**Fig. 5.44 Effect of Coir Pith on Cation Exchange Capacity**

Cation exchange capacity shows a steady increase in its value for addition of coir pith and the increase is linear and comparable as shown by Fig.5.44

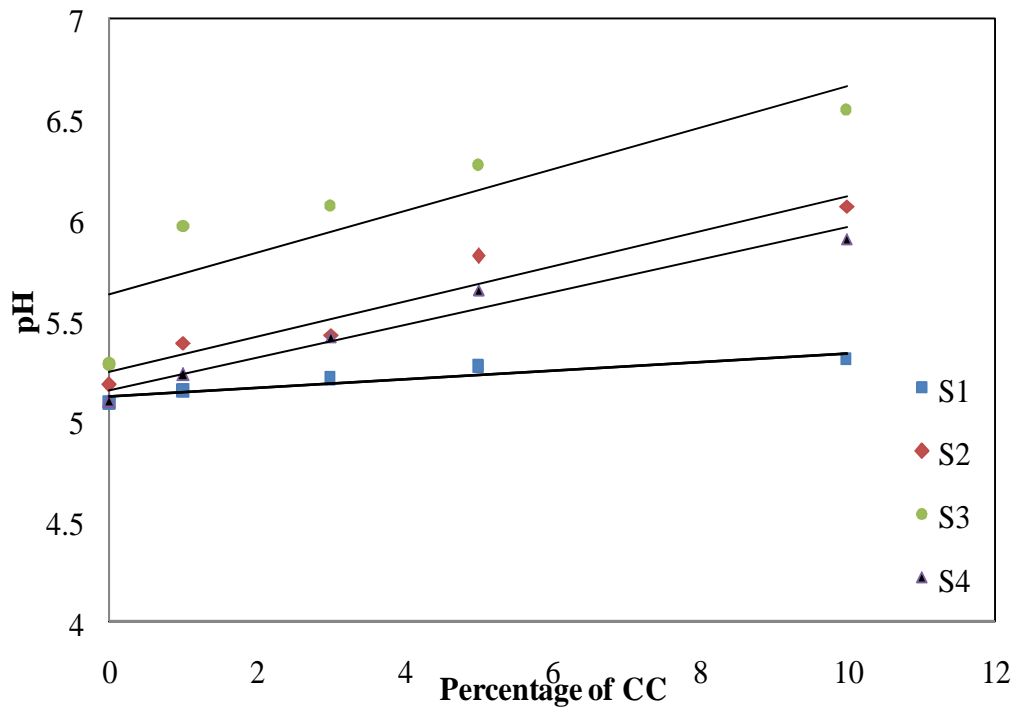
The results of the chemical analysis show that the admixtures coir pith does not interfere with the composition of the soil as a medium for plant growth.

### **5.5.3. Effect of Addition of Coir Pith Compost on Essential Elements**

The results of the chemical analysis carried out on untreated soils and soils treated with 1, 3, 5 and 10% of coir pith compost are presented in Table 5.8. and Fig.5.45 to 5.51

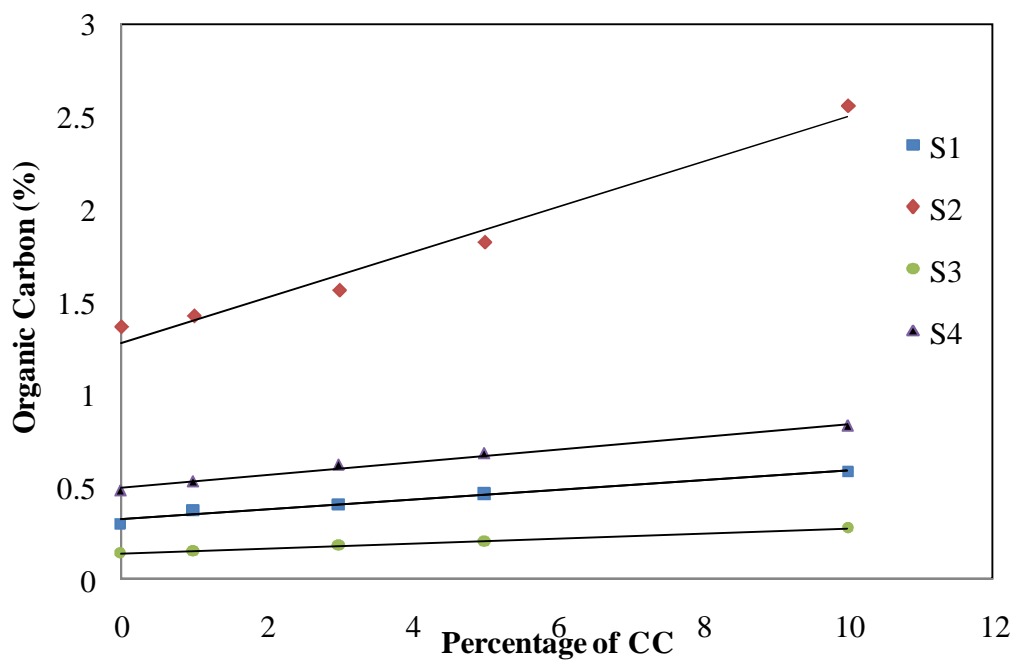
**Table 5.8 Effect of Coir pith Compost on pH value, Nutrients and Cation Exchange Capacity of Soils**

Sample No	pH	OC%	Available N kg/ha	Available P Kg/ha	Available K Kg/ha	Available Ca Kg/ha	Cation Exchange Capacity Cmolkg <sup>-1</sup>
S1	5.09	0.30	46.38	44.38	53.76	668.18	9.96
S1 + 1 % CC	5.15	0.37	53.28	56.30	73.69	710.10	10.64
S1 + 3 % CC	5.21	0.40	83.17	76.14	106.40	1132.50	12.28
S1 + 5 % CC	5.27	0.46	108.76	87.53	117.15	1221.92	14.94
S1 + 10% CC	5.31	0.58	143.95	143.68	196.67	1411.65	16.96
S2	5.18	1.36	240	12.36	380.80	1101.18	24.10
S2 + 1 % CC	5.39	1.42	247.90	16.21	386.91	1214.20	26.19
S2 + 3 % CC	5.43	1.56	254.30	25.22	396.26	1316.28	30.28
S2 + 5 % CC	5.82	1.82	283.33	36.17	411.20	1602.31	33.28
S2 + 10 % CC	6.07	2.56	321.87	55.37	426.22	1824.69	36.90
S3	5.28	0.14	126.00	8.24	188.16	285.60	3.35
S3 + 1 % CC	5.97	0.15	130.25	8.62	193.43	299.01	4.03
S3 + 3 % CC	6.07	0.18	136.82	8.87	207.16	326.22	6.49
S3 + 5 % CC	6.27	0.20	141.36	9.21	247.16	453.10	6.79
S3 + 10 % CC	6.55	0.28	153.95	9.68	291.12	585.27	7.62
S4	5.10	0.48	70	131.18	239.68	568.51	16.51
S4 + 1 % CC	5.23	0.53	76.77	133.93	280.89	605.52	17.06
S4 + 3 % CC	5.42	0.62	86.37	138.43	311.58	756.48	18.14
S4 + 5 % CC	5.65	0.68	132.50	140.63	357.28	897.88	20.16
S4 + 10 % CC	5.91	0.83	217.52	146.10	442.67	1003.70	21.06



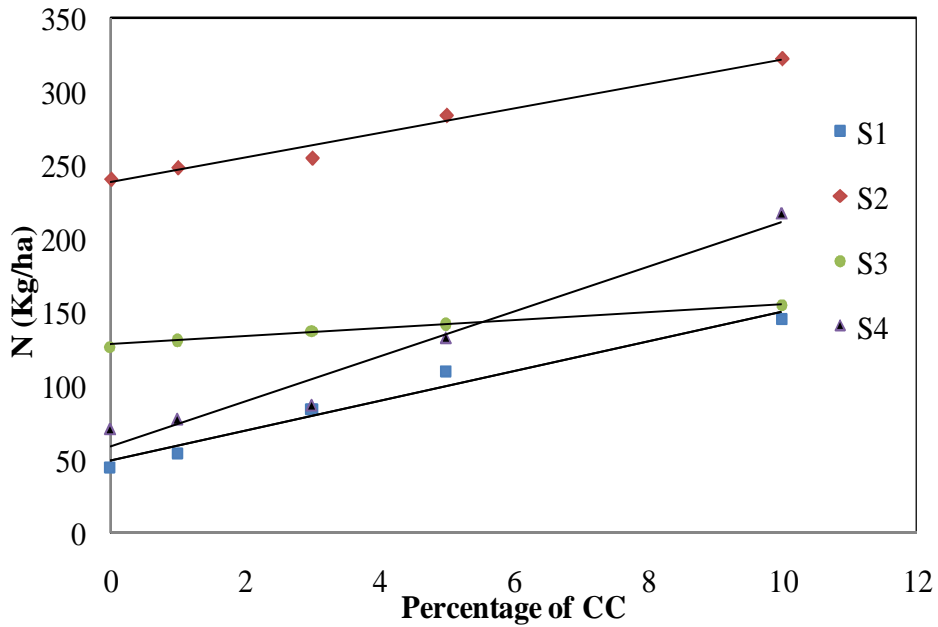
**Fig. 5.45 Effect of Coir pith Compost on pH value**

Fig.5.45 shows the pH value of all the four soils treated with coir pith compost. There is little increase in pH and as such the pH value is not sensitive to coir pith compost.



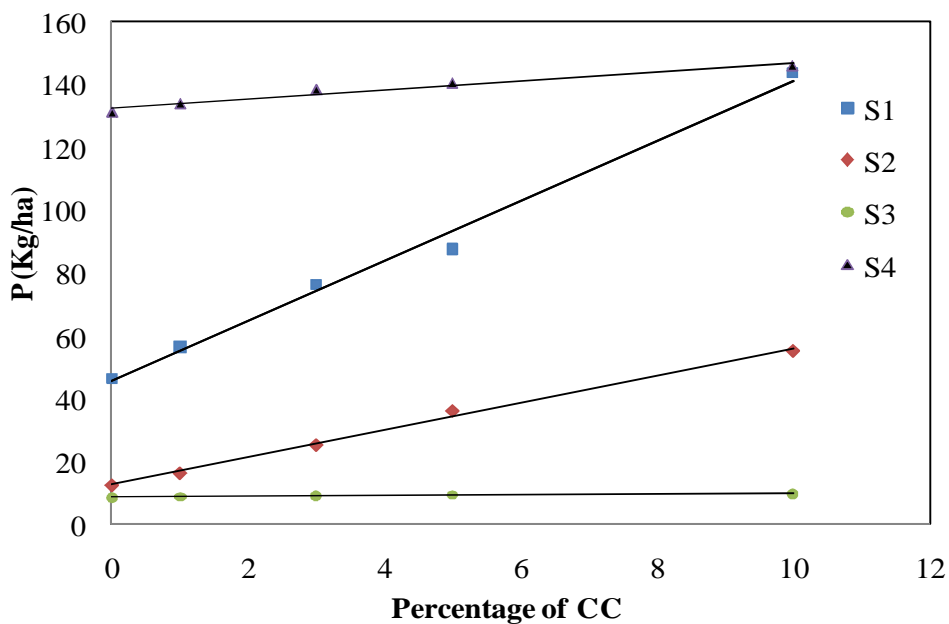
**Fig. 5.46 Effect of Coir pith Compost on Organic Carbon**

Soils S1, S2, S3, and S4 do not show much increase in organic carbon in addition of coir pith. Only the organic carbon values of soil S2, which has 72% fines, show a notable increase as shown in Fig.5.46



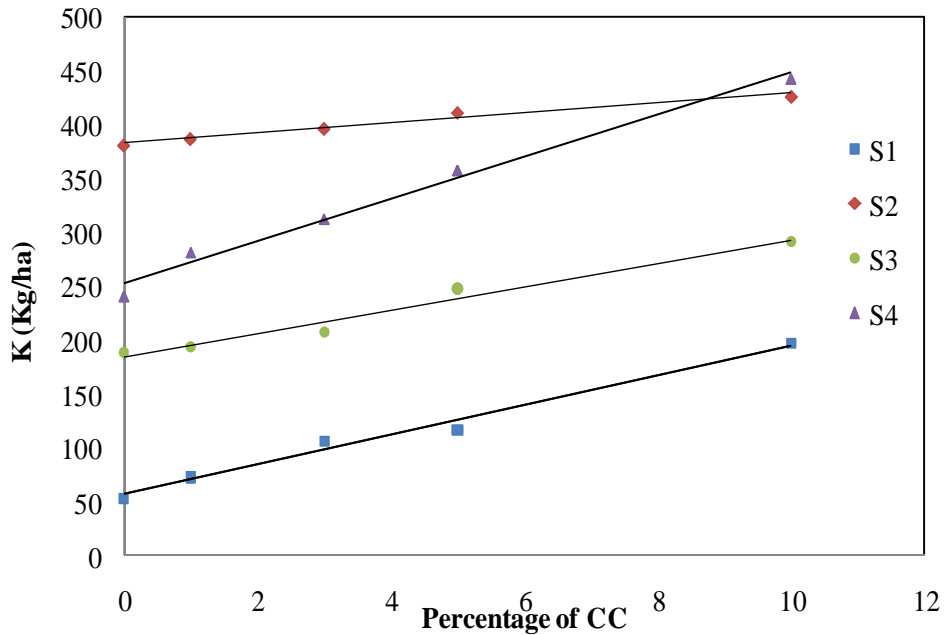
**Fig 5.47 Effect on Coir pith Compost on Nitrogen**

Fig.5.47 shows the variation of nitrogen with coir pith compost. The increase in soils S1, S2, S3 and S4 are steady and similar. The nitrogen content for all the soils even with an addition of 10% of coir pith compost are well within normally accepted value of 560.



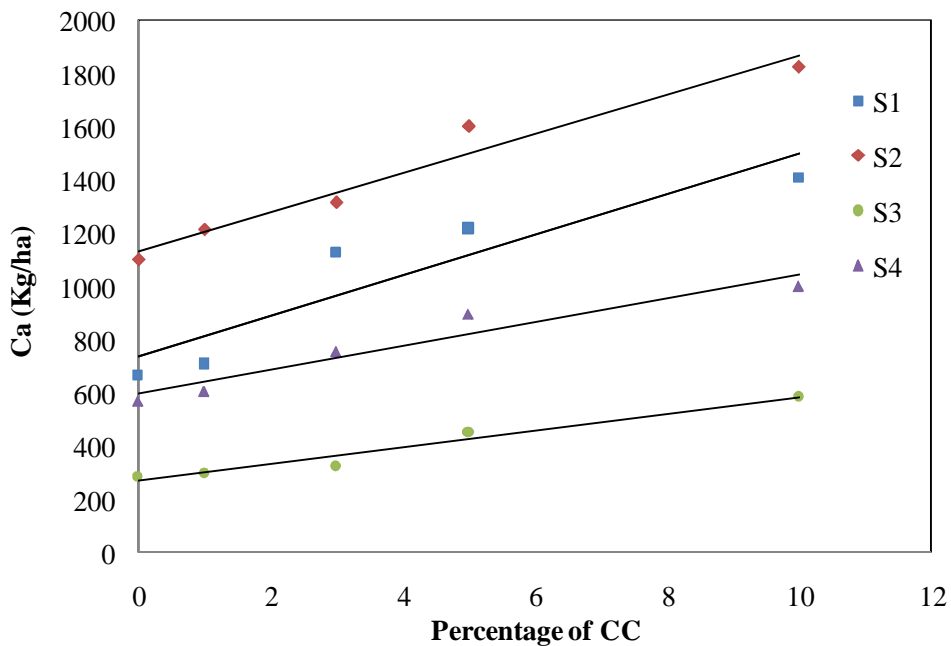
**Fig. 5. 48 Effect of Coir pith Compost on Phosphorous**

Fig. 5.48 shows that some soils S3 and S4 do not show any increase in the content of Phosphorous (P) on treatment with admixture coir pith compost. But soils S1 and S2 shows remarkable increase in P on addition of coir pith compost. Soil S1 shows an increase in P value from 46.38 to 143.68 which is an improvement by over 300%.



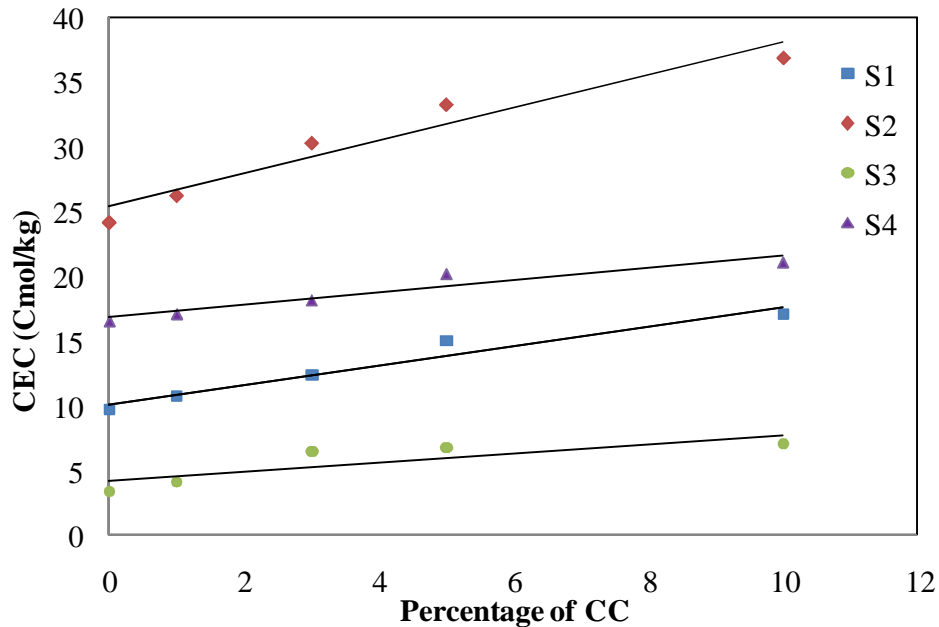
**Fig. 5.49 Effect of Coir pith Compost on Potassium**

The potassium (K) content values show notable improvement on treatment with coir pith compost except in case of soil S2. The variation of potassium content with the addition of coir pith compost is shown by figure 5.49.



**Fig. 5.50 Effect of Coir pith Compost on Calcium**

Fig.5.50 shows the relation between Calcium (Ca) and percentage of CC. There is steady increase in Ca value for all the four soils. The increases are within the limit values as shown in table 2.5 of section 2.



**Fig. 5.51 Effect of Coir pith Compost on Cation Exchange Capacity**

Fig.5.51 shows the relation between cation exchange capacity and coir pith compost. Cation exchange capacity also shows a steady increase with coir pith compost. In case of soils S1, S3 and S4 the values show a nonlinear improvement. In the case of soil S2 addition of 10% coir pith shows an increase in cation exchange capacity by 53.1%.

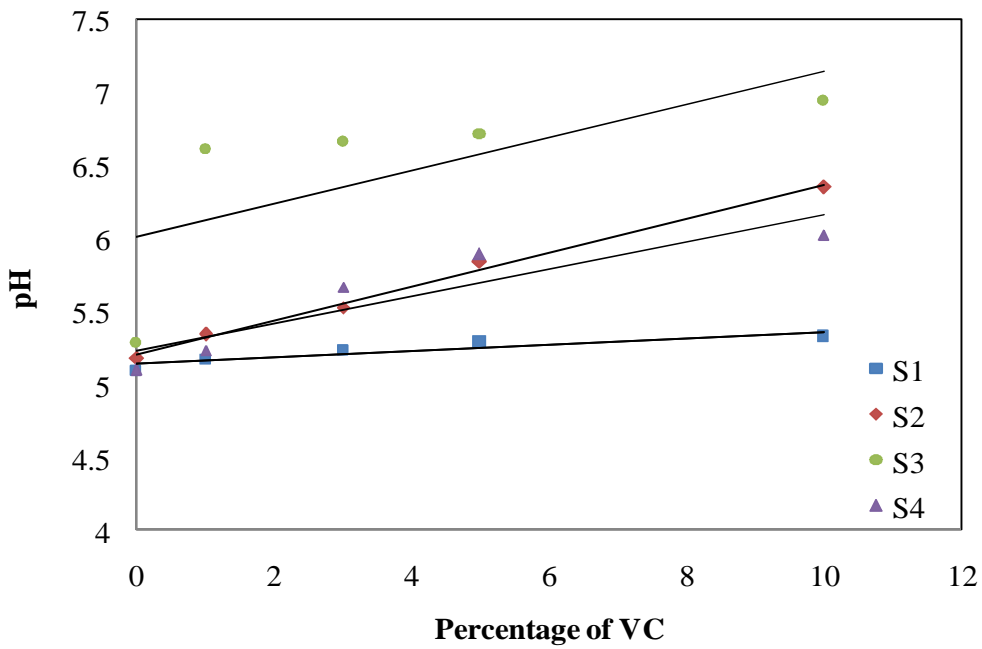
The results of all the tests show that the chemical properties of the soils are not adversely affected by treatment with coir pith compost. However the potential of coir pith compost to improve the water retention capacity of soil can be taken advantage of by treating the soils with coir pith compost as an admixture.

#### **5.5.4 Effect of Addition of Vermi Compost on Essential Elements**

The result of the chemical analysis carried out on untreated soil and soils treated with 1,3,5 and 10% of vermi compost are given in Table 5.9 and figures 5.52 to 5.58

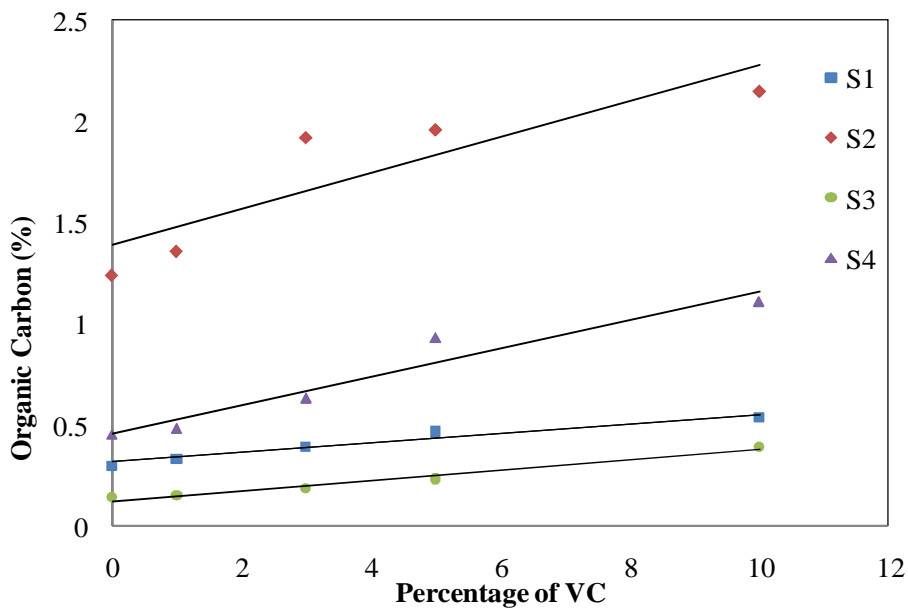
**Table 5.9 Effect of Vermi Compost on pH value, Nutrients and Cation Exchange Capacity of Soils**

Sample No	pH	OC%	Available N kg/ha	Available P Kg/ha	Available K Kg/ha	Available Ca Kg/ha	Cation Exchange Capacity Cmolkg <sup>-1</sup>
S1	5.09	0.30	46.38	44.38	53.76	668.18	9.98
S1 + 1 % VC	5.17	0.33	50.36	56.30	60.23	741.30	10.02
S1 + 3 % VC	5.23	0.39	55.98	76.14	68.39	948.20	11.11
S1 + 5 % VC	5.29	0.46	68.77	77.53	113.79	1221.43	12.78
S1 + 10 % VC	5.33	0.53	89.97	99.12	207.05	1449.22	15.91
S2	5.18	1.36	240.00	12.36	380.80	1101.18	24.10
S2 + 1 % VC	5.34	1.36	250.10	13.55	392.10	1197.21	25.56
S2 + 3 % VC	5.53	1.92	272.13	14.23	413.21	1682.50	26.92
S2 + 5 % VC	5.84	1.96	291.42	16.26	429.16	1907.46	28.94
S2 + 10 % VC	6.35	2.15	323.90	18.21	480.03	2384.71	35.90
S3	5.28	0.14	126	8.24	188.16	285.60	3.35
S3 + 1 % VC	6.61	0.15	139.17	8.34	192.84	291.62	4.13
S3 + 3 % VC	6.66	0.18	154.30	8.46	193.90	304.22	5.01
S3 + 5 % VC	6.71	0.23	160.78	8.83	198.40	320.55	5.23
S3 + 10 % VC	6.94	0.39	66.63	9.34	206.01	380.29	5.65
S4	5.10	0.48	70	131.18	239.68	568.51	16.81
S4 + 1 % VC	5.23	0.48	102.36	135.44	296.26	625.33	17.41
S4 + 3 % VC	5.67	0.63	179.13	139.23	373.30	896.45	18.90
S4 + 5 % VC	5.89	0.93	215.92	140.54	473.31	985.96	20.21
S4 + 10 % VC	6.02	1.11	235.52	143.78	579.26	1122.30	22.06



**Fig. 5.52 Effect of Vermicompost on pH**

Fig 5.52 shows the variation of pH value of soil treated with varying percentages of vermi compost. There is only marginal increase of pH in soil S1 and variation of pH values of soils S2, S3 and S4 are notable and are nearly to the limit as given in section 2 (Table 2.4) on addition of 10% vermi compost.

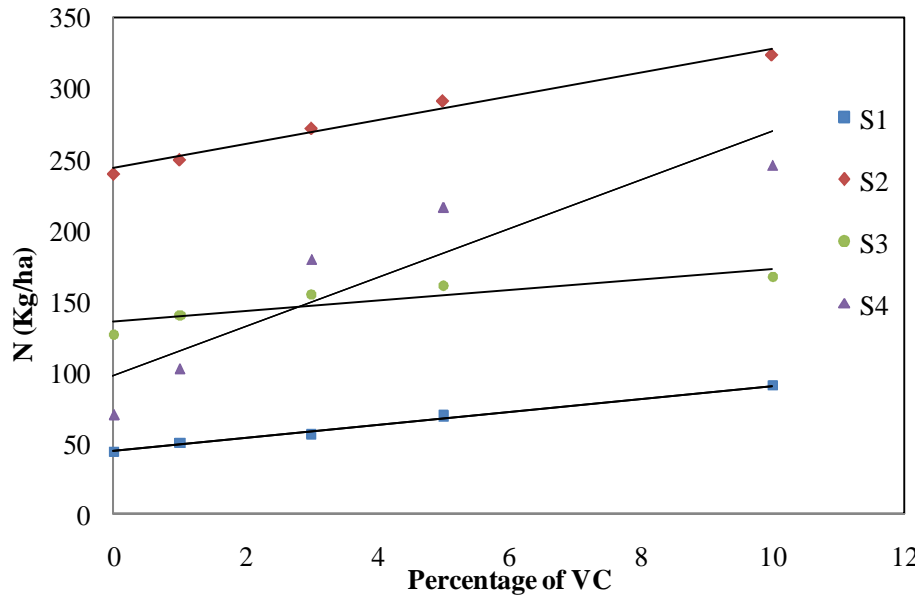


**Fig. 5.53 Effect of Vermicompost on Organic Carbon**

Fig 5.53 shows the variation in organic carbon on addition of vermi compost to the four soils. Organic carbon increases with the increasing percentage of the

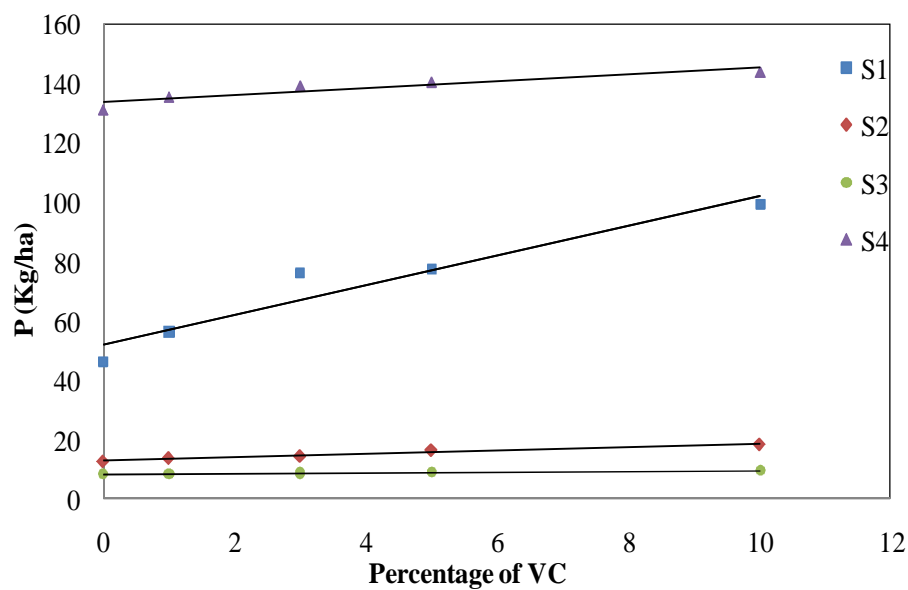


vermi compost in all soils. It shows that increase in organic carbon increases the fertility of the soil and the high carbon content reduces the quantity of fertilisers to be applied on the soils.



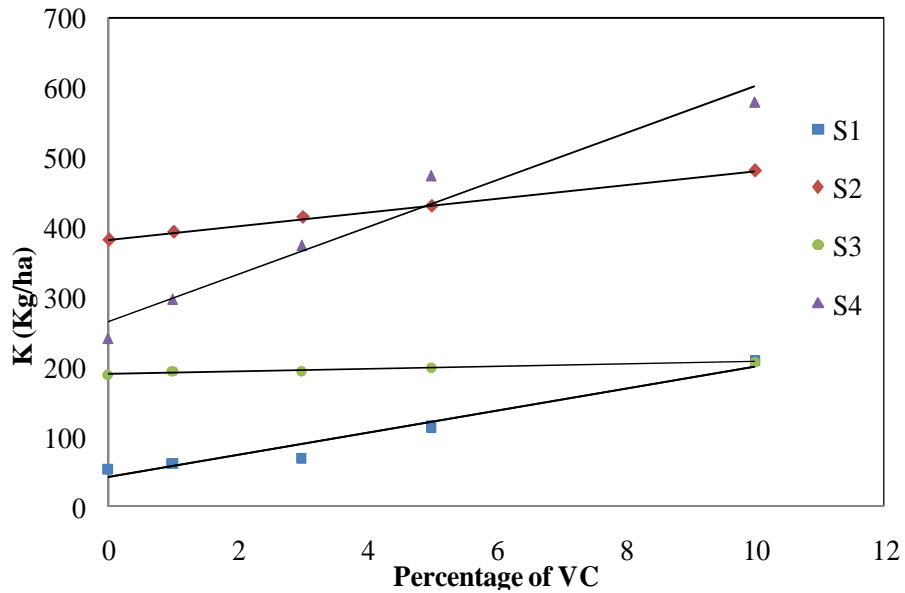
**Fig. 5.54 Effect of Vermicompost on Nitrogen**

Fig 5.54 shows the variation of available nitrogen with the addition of varying percentages of vermi compost. The value of available nitrogen is lower for soil S3 on 10% addition of vermi compost and in the case of soils S1, S2 and S4 it is within the required range (Table 2.5). The nitrogen content in soil S3 can be increased by adding the fertiliser potash, for the other soils the quantity of the fertiliser can be reduced.



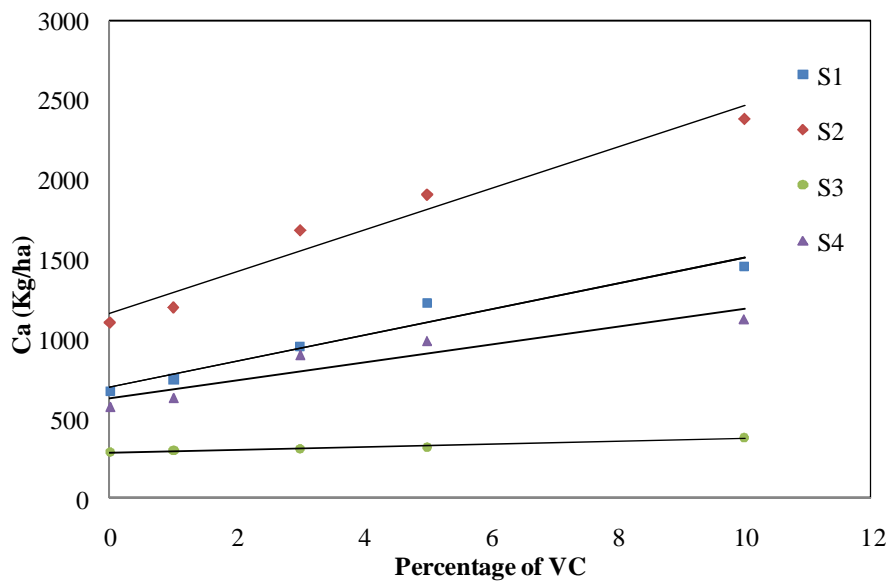
**Fig. 5.55 Effect of Vermicompost on Phosphorous**

Fig 5.55 shows the variation of phosphorous with the addition of varying percentage of vermi compost. For the soils S1 and S4 the values are higher and for soil S3 the values are lower than the described value and it can be improved by adding sufficient quantity of fertilizers containing phosphorous.



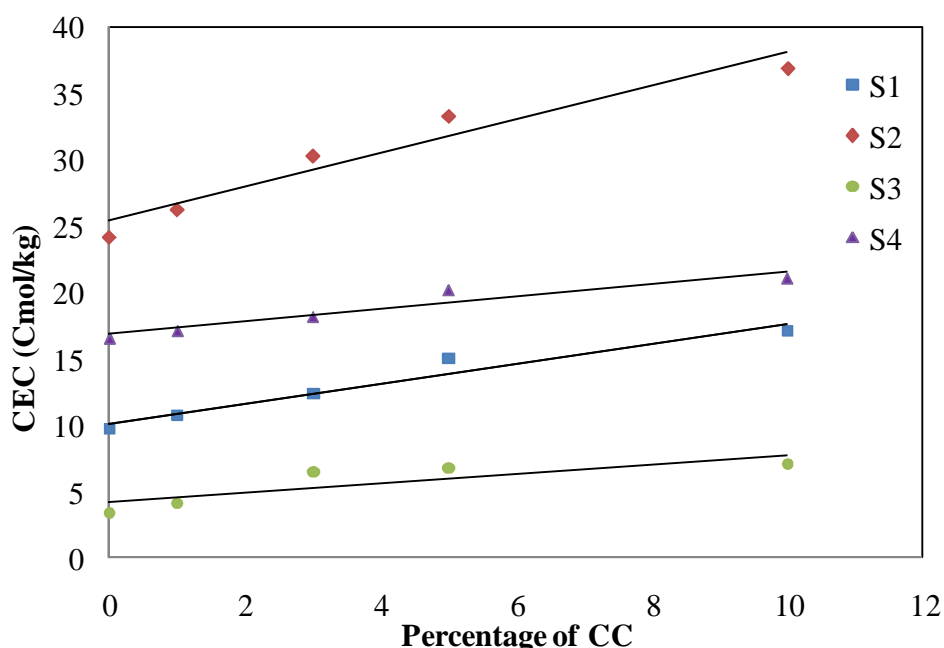
**Fig. 5.56 Effect of Vermicompost on Potassium**

Fig 5.56 shows the variation of potassium element with varying percentage of vermi compost. For soils S2 and S4 the values of the potassium content are above the required range and in soils S1 and S3 in the medium range (Table 2.5) and that can be improved by sufficient quantity of suitable fertilizers and in soils S2 and S4 the quantity of fertilizers can be reduced.



**Fig. 5.57 Effect of Vermicompost on Calcium**

Fig. 5.57 shows the variation of available calcium with varying percentage of vermi compost. The calcium ranges are within the limit (Table 2.5) for all type of soils.



**Fig. 5.58 Effect of Vermicompost on Cation Exchange Capacity**

Fig. 5.58 shows the variation of cation exchange capacity for soils with different percentage of vermi compost. Cation exchange capacity is an important fact showing the fertility of the soil. As the value increases fertility also increases and the absorbing power of the plant also increases. For 10% vermi compost added soil S2 cation exchange capacity value shows a remarkable increase and is nearer to the higher limit.

Tables 2.24 & 2.5(section2) show the limit values of soils for determining whether it is poor or good, considering fertility value. Tables 5.10 to 5.12 show the variation of the essential elements on treatment with 10% of CP, CC and VC.

**Table 5.10 Effects of pH value and Nutrients on Soil With 10% Coir Pith**

Soil+10% Coir pith	pH	OC (%)	N (Kg/ha)	P (Kg/ha)	K (Kg/ha)	Ca (Kg/ha)	CEC (cmol kg <sup>-1</sup> )
S1	5.22	0.69	135.95	77.2	84.62	1108.9	16.50
S2	5.97	2.49	290	18.11	494.33	1166.79	34.88
S3	6.07	0.26	156	12.57	220.34	462.33	7.91
S4	6.53	0.64	121.45	159.23	299.56	1180.20	21.25

**Table 5.11 Effect of pH value and Nutrients on Soil With 10% Coir Pith  
Compost**

Soil+10% Coir pith Compost	pH	OC (%)	N (Kg/ha)	P (Kg/ha)	K (Kg/ha)	Ca (Kg/ha)	CEC (cmol kg <sup>-1</sup> )
S1	5.31	0.58	143.80	143.68	196.67	1411.65	16.96
S2	6.07	2.56	321.87	55.37	426.22	1824.70	36.90
S3	6.55	0.28	153.95	9.68	291.12	585.27	7.62
S4	5.91	0.83	217.32	146.10	442.67	1003.70	21.06

**Table 5.12 Effect of pH value and Nutrients on Soil With 10% Vermi  
Compost**

Soil+10% Vermi compost	pH	OC (%)	N (Kg/ha)	P (Kg/ha)	K (Kg/ha)	Ca (Kg/ha)	CEC (cmol kg <sup>-1</sup> )
S1	5.33	0.53	89.97	99.12	207.05	1449.22	15.91
S2	6.35	2.15	323.9	18.21	480.03	2384.71	35.9
S3	6.94	0.39	166.63	9.34	206.01	380.29	5.65
S4	6.02	1.11	215.92	143.78	579.26	1122.3	22.06

## **5.6. STUDY ON HYDRAULIC CONDUCTIVITY OF SOIL**

Any factor affecting the size and configuration of soil pores will influence hydraulic conductivity. The total flow rate in soil pores is proportional to the fourth power of radius of pores. Thus, flow through a pore 1mm in radius is equivalent to that in 10,000 pores with a radius of 0.1mm, even though it takes only 100 pores of radius 0.1mm to give the same cross-sectional area of a 1mm pore. Obviously, the macropore spaces will account for most of the saturated water movement in soils.

The texture and structure of soils are the properties to which hydraulic conductivity is most directly related. Sandy soils generally have higher saturated conductivities than finer textured soils. Likewise, soils with stable granular structure conduct water much more rapidly than those with unstable structural units, which break down upon being wetted. Fine clay and silt can clog the small connecting channels of even the larger pores. Fine-textured soils that crack during dry weather at

first allow rapid water movement; later, the cracks swell shut, thereby drastically reducing water movement.

### **5.6.1 Variation of Water Content with Fineness of Soil**

Field capacity is the water that is retained in the soil after water has been drained off by gravity. Similarly plant wilting point is the water content that is left in the soil after application of suction heads of 15 bar for sufficient time by pressure plate apparatus. Thus in either case the hydraulic conductivity or the ease with which water flows out of the soil mass determine the two most important parameters then water retention capabilities of soils are analysed. Under these circumstances study of hydraulic conductivity of soil with and without admixture is relevant.

Fig 4.8 (section 4.34) shows the plant available water which is the difference between field capacity and permanent wilting point for soils ranging over sand, sandy loam, loam, silty loam, clayey loam and clay. Since the permeability is high for sand the field capacity which is the water content after gravitational flow is low. Similarly permanent wilting point as well as plant available water are low. It can be observed that in case of sandy loam where the permeability is lower, all the three values are higher than those of sand. Obviously the hydraulic conductivity or permeability is high for sand and low for clay. Permanent wilting point can be said to be inversely proportional to hydraulic conductivity.

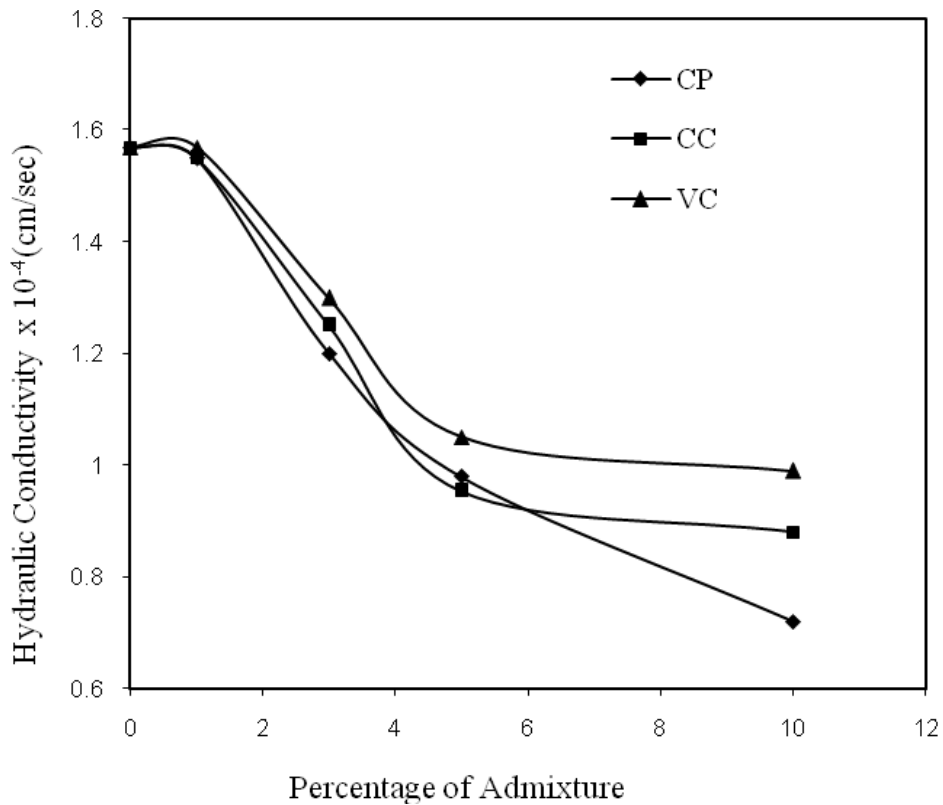
Field capacity improves from sandy soils to silty loam and thereafter the value does not vary much. The net result is the available water is maximum for soils falling between the sandy loam and silty loam.

### **5.6.2 Effect of Admixtures on Hydraulic Conductivity**

Whether addition of admixtures affects the soil structure and hydraulic conductivity adversely has to be verified for the three admixtures used. This has been done by conducting a series of permeability tests on all four soils. The results are presented in Table 5.13.

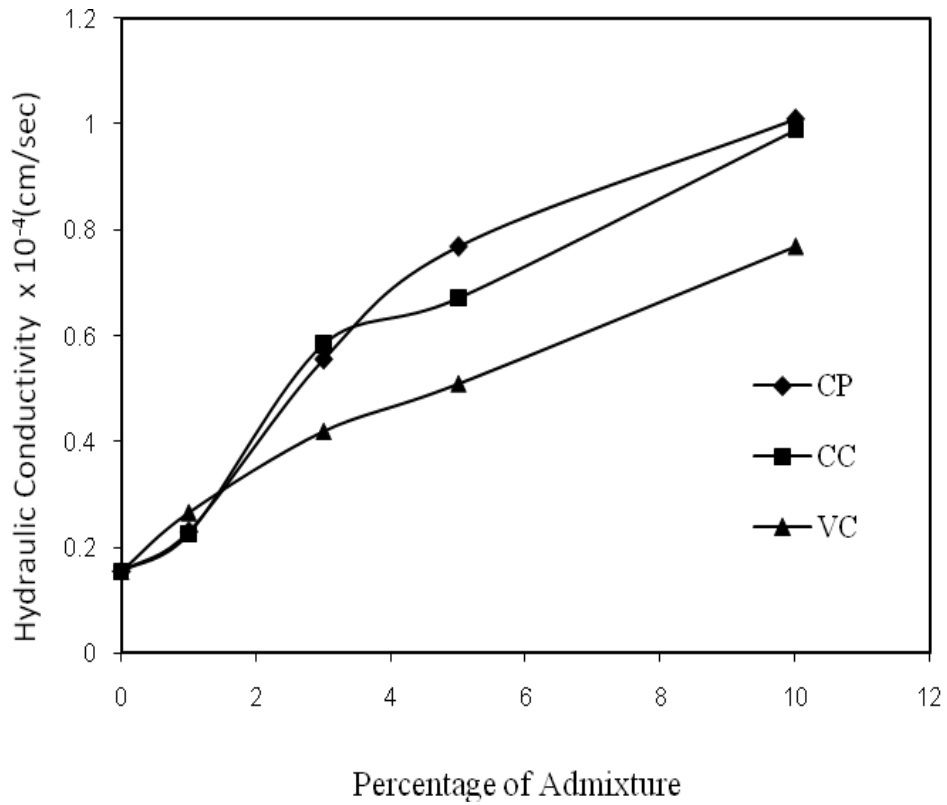
Fig 5.59 shows the values of hydraulic conductivity for soil S1 when treated with varying percentage of Coir Pith (CP), Coir pith Compost (CC) and Vermicompost (VC). It can be seen that the coefficient of permeability decreases with the

addition of admixtures and the decrease is maximum when CP is added followed by CC and VC. It has also be seen earlier that the percentage increase in available water also significantly increased in S1 by the addition of admixtures.



**Fig 5.59 Effect of Admixtures on Hydraulic Conductivity of S1**

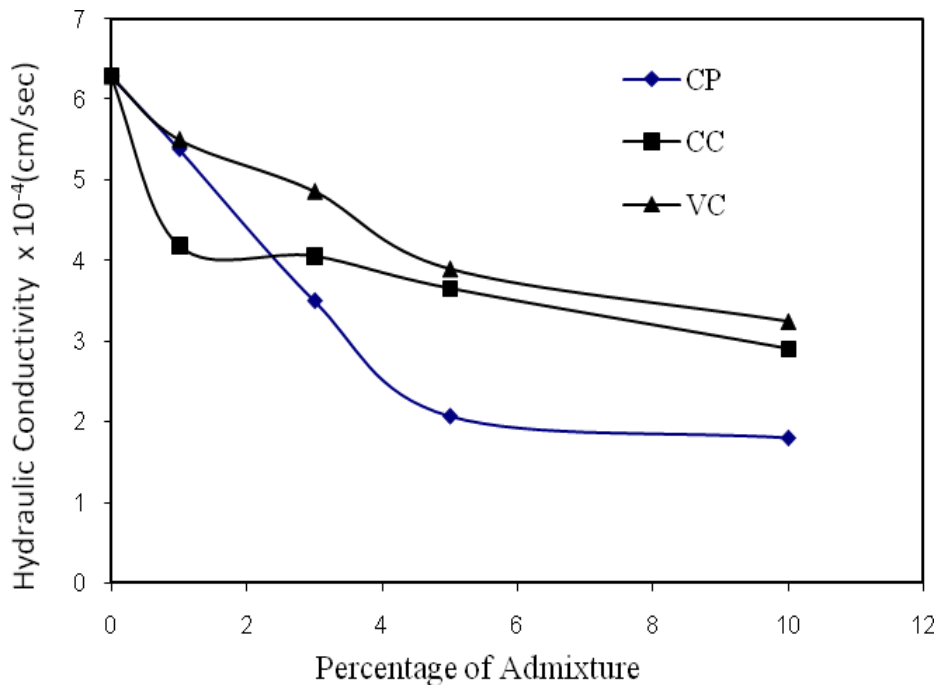
Fig. 5.60 shows the hydraulic conductivity values for soil S2 when treated with varying percentage of CP, CC and VC. It can be seen that the coefficient of permeability increases with the addition of admixtures and the increase is maximum when CP is added followed by CC and VC. It has also been seen that the percentage increase in available water also significantly increased in S1 by the addition of admixtures.



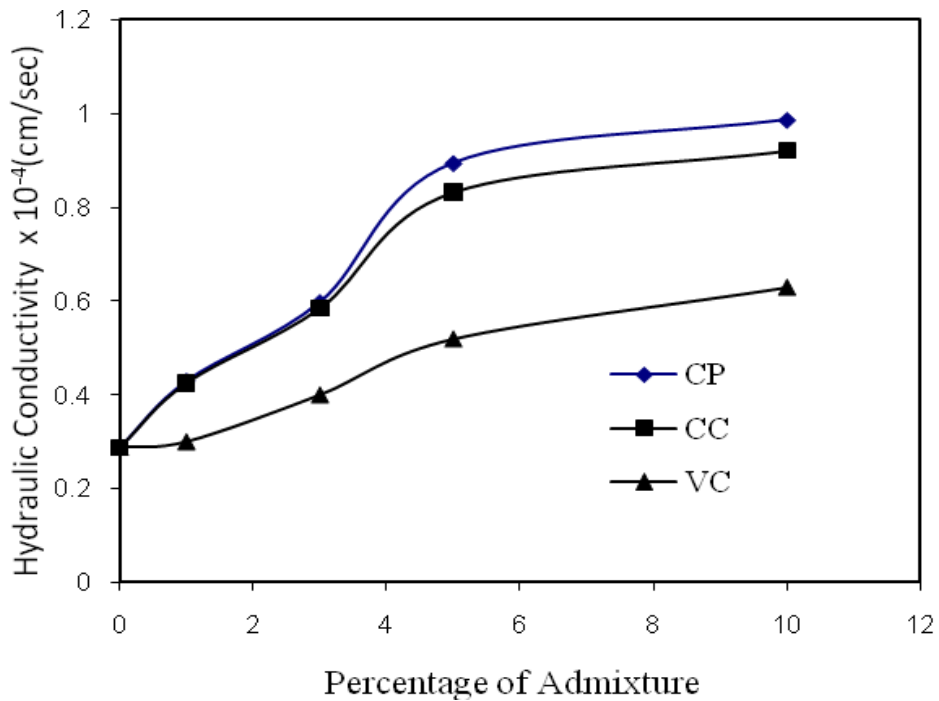
**Fig 5.60 Effect of Admixtures on Hydraulic Conductivity of S2**

Fig. 5.61 shows the permeability values for soil S3 which has 94% of sand. The permeability of the soil is  $6.28 \times 10^{-4}$  cm/sec. From Table 5.3 it is clear that for this soil the field capacity and plant available water are considerably lower than S2 and S4. By proper treatment with admixtures the permeability could be brought down as is evident from the result presented in the Table 5.13.

Fig. 5.62 shows the effect of admixtures on hydraulic conductivity of soil S4. Similar to the case of soil S2 here also there is a slight increase in permeability.



**Fig 5.61 Effect of Admixtures on Hydraulic Conductivity of S3**



**Fig 5.62 Effect of Admixtures on Hydraulic Conductivity of S4**

From the figures and tables it can be seen that the three admixture do not have any adverse effect on the hydraulic conductivity of the soils.



**Table 5.13 Effect of Admixtures on the Hydraulic Conductivity of Different Soils**

Soil type	hydraulic conductivity (cm/sec)		
	CP	CC	VC
S1	$1.57 \times 10^{-4}$	$1.57 \times 10^{-4}$	$1.57 \times 10^{-4}$
S1 + 1%	$1.55 \times 10^{-4}$	$1.55 \times 10^{-4}$	$1.57 \times 10^{-4}$
S1 + 3%	$1.2 \times 10^{-4}$	$1.25 \times 10^{-4}$	$1.3 \times 10^{-4}$
S1 + 5%	$9.8 \times 10^{-5}$	$9.53 \times 10^{-5}$	$1.05 \times 10^{-4}$
S1 + 10%	$7.2 \times 10^{-5}$	$8.8 \times 10^{-5}$	$9.9 \times 10^{-5}$
S2	$1.55 \times 10^{-5}$	$1.55 \times 10^{-5}$	$1.55 \times 10^{-5}$
S2 + 1%	$2.3 \times 10^{-5}$	$2.26 \times 10^{-5}$	$2.66 \times 10^{-5}$
S2 + 3%	$5.56 \times 10^{-5}$	$5.85 \times 10^{-5}$	$4.2 \times 10^{-5}$
S2 + 5%	$7.69 \times 10^{-5}$	$6.72 \times 10^{-5}$	$5.1 \times 10^{-5}$
S2 + 10%	$1.01 \times 10^{-4}$	$9.9 \times 10^{-5}$	$7.7 \times 10^{-5}$
S3	$6.28 \times 10^{-4}$	$6.28 \times 10^{-4}$	$6.28 \times 10^{-4}$
S3 + 1%	$5.38 \times 10^{-4}$	$4.18 \times 10^{-4}$	$5.50 \times 10^{-4}$
S3 + 3%	$3.50 \times 10^{-4}$	$4.05 \times 10^{-4}$	$4.86 \times 10^{-4}$
S3 + 5%	$2.07 \times 10^{-4}$	$3.65 \times 10^{-4}$	$3.9 \times 10^{-4}$
S3 + 10%	$1.80 \times 10^{-4}$	$2.90 \times 10^{-4}$	$3.25 \times 10^{-4}$
S4	$2.89 \times 10^{-5}$	$2.89 \times 10^{-5}$	$2.89 \times 10^{-5}$
S4 + 1%	$4.3 \times 10^{-5}$	$4.26 \times 10^{-5}$	$3.01 \times 10^{-5}$
S4 + 3%	$5.98 \times 10^{-5}$	$5.85 \times 10^{-5}$	$4.01 \times 10^{-5}$
S4 + 5%	$8.94 \times 10^{-5}$	$8.32 \times 10^{-5}$	$5.2 \times 10^{-5}$
S4 + 10%	$9.86 \times 10^{-5}$	$9.2 \times 10^{-5}$	$6.3 \times 10^{-5}$

### **5.7 EFFECT OF PLANTING ON TREATED SOILS**

The main objective of the present study is to increase the water utilization efficiency of different soils with the help of admixtures. It has already been proved that both the water retaining agencies ie; coir pith and coir pith compost and the water retaining and fertilizing agency ie; vermi compost help to promote the water

retention capabilities of the soils they are by assisting in increasing the irrigation interval and supply of water at specified intervals

A comparative study of the results of the tests on untreated and treated soils for pH, OC, NPK, Ca and cation exchange capacity of all the four soils before and after the introduction of the admixtures show that the variations are not significant to influence the chemical balance that exists in soils. The only concern is for coir pith whose addition in higher percentage may upset the carbon – nitrogen ratio whose value should be kept minimum for better utilization of manures especially organic matter which is the trend of the day. Similarly how the water retention capability and the chemical properties vary when plants actually grow in the soils treated with admixtures was also investigated.

This was done in two parts- one through chemical analysis of the soil itself and another by chemical analysis of the water that seeps through the treated soil to check whether the treatment affects the water quality.

### **5.7.1 Chemical Analysis of Treated Soils after Planting**

As mentioned earlier, in order to study whether the admixtures will affect the chemistry of the soil with adverse effect on plant growth was investigated in detail.

All the four soils were treated with 1,3,5 and 10 % of coir pith, coir pith compost and vermin compost and collected in garden pots. Brinjal seedlings were planted and allowed to grow for three months. Investigations were done at intervals ensuring that the water content never went below 50% of the field capacity. After allowing the plants to grow for three months the soils were again subject to chemical analysis of pH, OC, N, P, K, Ca and CEC. The results were presented in tables 5.14 and 5.15 for coir pith.

**Table 5.14: Effect of CP on pH, OC, and CEC before and after Planting**

Soil type	pH		OC		CEC	
	1	2	1	2	1	2
S1	5.09	5.12	0.30	0.29	9.96	9.89
S1+1%CP	5.11	5.10	0.36	0.33	10.50	10.44
S1+3%CP	5.13	5.11	0.36	0.44	12.30	12.26
S1+5%CP	5.19	5.16	0.55	0.54	14.67	14.62
S1+10%CP	5.22	5.20	0.69	0.67	16.50	16.45
S2	5.18	5.19	1.36	1.35	24.10	24.00
S2+1%CP	5.41	5.40	1.38	1.37	25.23	25.19
S2+3%CP	5.45	5.42	1.41	1.39	27.13	27.10
S2+5%CP	5.59	5.57	1.45	1.42	28.68	28.64
S2+10%CP	5.97	5.90	2.49	2.47	34.88	34.70
S3	5.28	5.30	0.14	0.14	3.35	3.35
S3+1%CP	5.51	5.49	0.16	0.15	3.59	3.55
S3+3%CP	5.76	5.63	0.19	0.16	5.25	5.20
S3+5%CP	5.81	5.80	0.20	0.18	6.32	6.27
S3+10%CP	6.07	6.01	0.26	0.24	7.91	7.86
S4	5.10	5.11	0.45	0.45	16.81	16.79
S4+1%CP	5.91	5.85	0.50	0.49	17.10	17.08
S4+3%CP	5.99	5.87	0.52	0.50	18.19	18.15
S4+5%CP	6.30	6.21	0.55	0.54	19.06	19.02
S4+10%CP	6.53	6.51	0.64	0.62	21.25	21.21

1- Measured immediately after mixing

2- Measured after three months

**Table 5.15 Effect of CP on N, P, K, Ca before and after Planting**

Soil type	N		P		K		Ca	
	1	2	1	2	1	2	1	2
S1	46.38	46.30	44.38	44.38	53.76	53.70	666.18	665.12
S1+1%CP	49.58	49.46	48.58	48.49	57.34	57.30	706.41	705.22
S1+3%CP	60.78	60.69	60.33	60.27	64.74	64.69	906.41	904.36
S1+5%CP	74.20	74.16	63.98	63.95	69.22	69.18	1011.38	1008.72
S1+10%CP	135.95	135.89	77.20	77.17	84.62	84.59	1108.90	1106.66
S2	240.00	239.01	12.36	12.30	380.80	380.01	1101.18	998.93
S2+1%CP	248.00	243.00	12.37	12.20	387.52	382.01	1103.52	1103.10
S2+3%CP	252.00	246.00	12.51	12.25	427.84	416.92	1126.49	1120.96
S2+5%CP	260.00	253.00	15.01	14.81	443.52	434.52	1146.21	1142.20
S2+10%CP	290.00	274.00	18.11	18.08	494.33	492.62	1166.79	1161.92
S3	126.00	125.80	8.24	8.23	118.16	118.01	285.60	283.71
S3+1%CP	129.00	127.00	8.24	8.19	190.30	187.28	408.35	402.35
S3+3%CP	135.00	128.00	9.76	9.43	195.46	193.24	425.32	421.23
S3+5%CP	140.00	136.00	10.31	10.12	201.60	197.42	449.79	444.68
S3+10%CP	156.00	151.00	12.57	12.02	220.34	218.34	462.33	460.55
S4	70.00	70.00	131.18	131.00	239.68	236.10	568.51	565.31
S4+1%CP	84.00	79.00	135.10	132.80	248.64	244.52	605.92	601.55
S4+3%CP	91.00	85.00	142.24	139.10	271.01	266.93	756.48	749.48
S4+5%CP	105.00	97.00	143.53	141.28	282.21	275.99	797.88	790.52
S4+10%CP	121.45	120.24	159.23	156.88	299.56	296.86	1180.20	1173.21

1- Measured immediately after mixing

2- Measured after three months

Table 5.14 shows a comparison of the value pH, OC and CEC for all the soils as soon as the soils were mixed with the coir pith and three months after the mixing, allowing plants to grow. It can be seen that the variation is negligible.

Table 5.15 shows a comparison of the values of NPK and Ca on mixing with coir pith and three months later. As in the earlier case the difference are not significant.

Similarly table 5.16 presents the values of pH, OC and CEC for all soils immediately on treatment with CC and after allowing plants to grow for three months. Table 5.17 gives the values of N, P, K , Ca on mixing and after three months.

Tables 5.18 and 5.19 show the similar results for vermin compost for pH, OC, CEC, NPK and Ca values for all soils immediately on treatment and after allowing plants to grow for three months.

It can be seen that the chemical properties are not affected by treatment of the soils with coir pith, coir pith compost and vermi compost.

**Table 5.16 Effect of CC on pH, OC, and CEC before and after Planting**

Soil type	pH		OC		CEC	
	1	2	1	2	1	2
S1	5.09	5.12	0.30	0.29	9.96	9.89
S1+1%CC	5.15	5.12	0.37	0.33	10.64	10.62
S1+3%CC	5.21	5.18	0.40	0.37	12.28	12.25
S1+5%CC	5.27	5.25	0.46	0.43	14.94	14.90
S1+10%CC	5.31	5.29	0.58	0.56	16.96	16.85
S2	5.18	5.19	1.36	1.35	24.10	24.00
S2+1%CC	5.39	5.36	1.42	1.40	26.19	26.16
S2+3%CC	5.43	5.40	1.56	1.53	30.28	30.24
S2+5%CC	5.82	5.79	1.82	1.80	33.28	33.20
S2+10%CC	6.07	6.03	2.56	2.52	36.90	36.75
S3	5.28	5.30	0.14	0.14	3.35	3.35
S3+1%CC	5.97	5.96	0.15	0.13	4.03	4.01
S3+3%CC	6.07	6.07	0.18	0.16	6.49	6.48
S3+5%CC	6.27	6.23	0.20	0.19	6.79	6.76
S3+10%CC	6.55	6.50	0.28	0.26	7.62	7.60
S4	5.10	5.11	0.45	0.45	16.81	16.79
S4+1%CC	5.23	5.20	0.53	0.51	17.06	17.01
S4+3%CC	5.42	5.40	0.62	0.60	18.14	18.03
S4+5%CC	5.65	5.60	0.68	0.65	20.16	20.00
S4+10%CC	5.91	5.84	0.83	0.80	21.06	20.95

1- Measured immediately after mixing

2- Measured after three months

**Table 5.17 Effect of CC on N,P,K and Ca before and after Planting**

Soil type	N		P		K		Ca	
	1	2	1	2	1	2	1	2
S1	46.38	46.30	44.38	44.38	53.76	53.70	666.18	665.12
S1+1%CC	53.28	52.03	56.30	55.77	73.69	73.11	710.10	708.48
S1+3%CC	83.17	83.01	76.14	75.68	106.40	105.92	1132.50	1130.44
S1+5%CC	108.76	108.60	87.53	87.09	117.15	116.68	1221.92	1218.78
S1+10%CC	143.95	143.60	143.68	142.94	196.67	196.22	1411.65	1408.52
S2	240.00	239.01	12.36	12.30	380.80	380.01	1101.18	998.93
S2+1%CC	247.91	247.20	16.21	16.18	386.91	386.09	1214.20	1212.86
S2+3%CC	254.30	253.01	25.22	25.17	396.26	395.85	1316.28	1313.95
S2+5%CC	283.33	283.01	36.17	36.14	411.22	410.62	1602.31	1601.12
S2+10%CC	321.87	321.16	55.37	55.33	426.22	425.74	1824.69	1822.88
S3	126.00	125.80	8.24	8.23	118.16	118.01	285.60	283.71
S3+1%CC	130.25	129.98	8.62	8.60	193.43	192.86	299.01	297.66
S3+3%CC	136.82	138.10	8.87	8.85	207.16	206.06	326.22	324.79
S3+5%CC	141.36	340.80	9.21	9.20	247.16	246.35	453.10	451.80
S3+10%CC	153.95	153.10	9.68	9.65	291.12	290.10	585.27	583.77
S4	70.00	70.00	131.18	131.00	239.68	236.10	568.51	565.31
S4+1%CC	76.77	76.17	133.93	133.08	280.89	280.01	605.52	604.82
S4+3%CC	86.37	85.98	138.43	137.83	311.58	310.82	756.48	755.50
S4+5%CC	132.50	132.11	140.63	139.92	357.28	356.62	897.88	896.90
S4+10%CC	217.52	217.01	146.10	145.30	442.67	440.88	1003.70	1001.90

1- Measured immediately after mixing

2- Measured after three months

**Table 5.18 Effect of VC on pH, OC, and CEC before and after Planting**

Soil type	pH		OC		CEC	
	1	2	1	2	1	2
S1	5.09	5.12	0.30	0.29	9.96	9.89
S1+1%VC	5.17	5.20	0.33	0.32	10.02	10.01
S1+3%VC	5.23	5.25	0.39	0.37	11.11	11.08
S1+5%VC	5.29	5.31	0.46	0.44	12.78	12.68
S1+10%VC	5.33	5.33	0.53	0.51	15.91	15.83
S2	5.18	5.19	1.36	1.35	24.10	24.00
S2+1%VC	5.34	5.36	1.36	1.29	25.36	25.15
S2+3%VC	5.53	5.58	1.92	1.88	26.92	26.55
S2+5%VC	5.84	5.87	1.96	1.93	28.94	28.64
S2+10%VC	6.35	6.36	2.15	2.09	35.90	35.44
S3	5.28	5.30	0.14	0.14	3.35	3.35
S3+1%VC	6.61	6.64	0.15	0.14	4.13	4.11
S3+3%VC	6.66	6.68	0.18	0.17	5.01	5.00
S3+5%VC	6.71	6.72	0.23	0.21	5.23	5.13
S3+10%VC	6.94	6.95	0.39	0.37	5.65	5.61
S4	5.10	5.11	0.45	0.45	16.81	16.79
S4+1%VC	5.23	5.25	0.48	0.44	17.41	17.01
S4+3%VC	5.67	5.69	0.63	0.60	18.90	18.23
S4+5%VC	5.89	5.90	0.93	1.08	20.21	19.83
S4+10%VC	6.02	6.04	1.11	0.91	22.06	21.80

1- Measured immediately after mixing

2- Measured after three months



**Table 5.19 Effect of VC on N,P,K and Ca before and after Planting**

Soil type	N		P		K		Ca	
	1	2	1	2	1	2	1	2
S1	46.38	46.30	44.38	44.38	53.76	53.70	666.18	665.12
S1+1%VC	50.36	50.12	56.30	56.01	60.23	60.01	741.30	740.16
S1+3%VC	55.98	55.08	76.14	75.98	68.39	68.02	948.20	946.67
S1+5%VC	68.77	68.33	77.53	77.02	113.79	112.34	1221.43	1220.48
S1+10%VC	89.97	89.55	99.12	98.80	207.05	206.89	1449.22	1440.60
S2	240.00	239.01	12.36	12.30	380.80	380.01	1101.18	998.93
S2+1%VC	250.10	249.80	13.55	13.50	392.10	391.90	1197.21	1185.20
S2+3%VC	272.13	271.90	14.23	14.00	413.21	412.90	1682.50	1662.50
S2+5%VC	291.42	290.60	16.26	15.12	429.16	428.99	1907.46	1880.46
S2+10%VC	323.90	322.80	18.21	17.80	480.03	479.93	2384.71	2340.20
S3	126.00	125.80	8.24	8.23	118.16	118.01	285.60	283.71
S3+1%VC	139.17	91.01	8.34	8.31	192.84	190.80	291.62	290.01
S3+3%VC	134.30	60.38	8.46	8.35	193.90	190.01	304.22	300.80
S3+5%VC	160.78	54.12	8.83	8.60	198.40	195.31	320.55	315.15
S3+10%VC	16.63	66.22	9.34	8.90	206.01	201.12	380.29	371.02
S4	70.00	70.00	131.18	131.00	239.68	236.10	568.51	565.31
S4+1%VC	102.36	101.86	135.44	133.18	295.01	295.01	625.33	621.31
S4+3%VC	179.13	177.93	139.23	136.90	373.30	370.20	896.45	890.20
S4+5%VC	215.92	215.23	140.54	138.20	473.31	468.30	685.96	665.35
S4+10%VC	235.82	215.12	143.78	140.70	579.26	570.12	1122.30	1102.31

### 5.7.2 Chemical analysis of the effluent water

There are standard values for the quality of water used for irrigation. When soil is treated with additives, the water used for irrigation may be allowed through interaction with the additives. If the quality of water that stays or seeps through the soils is affected by the admixture, it may affect the plant growth. Hence whether such chemical changes occur when water is allowed to interact with the admixture was verified by comparing the quality of water that was used for irrigation and the water is comes out as effluent from the treated soil which has been supporting the plants for three months. The water at the time incorporating the admixture and three months later was tested for the following,

1. pH
2. Total dissolved solids (ppm)
3. Total Hardness (as CaCO<sub>3</sub>) (ppm)
4. Fluoride (as F) (ppm)
5. Acidity (ppm)
6. Alkalinity (ppm)
7. Iron (as Fe) (ppm)
8. Chloride (as chlorine) (ppm)
9. Sulphites (as SO<sub>4</sub>) (ppm)
10. Residual free chlorine (ppm)
11. Nitrate (as NO<sub>3</sub>) (ppm)

The analyses were conducted using standard methods for water and waste water prepared by American public health association and as per IS method. The samples were analysed in the Government Analyst Laboratory, Trivandrum and Laboratory of Environmental Engineering, College of Engineering, Trivandrum.

The experimental setup to study the effect of effluent water with out plants is shown in Fig. 3.14 of section 3.3.4 and with plants is shown in Fig. 5.63



**Fig. 5.63 Experimental Set up (3 months after Planting)**

**Table 5.20 Effect of CP on Effluent Water for S1 after Planting**

Sl. No.	Parameter that controls the quality characteristics	Range of Parameter as per Standard	Parameter of water used	Quality of soil after 3 months without planting	Quantity of water from the soil treated with 10% CP 3 months after planting.
1	pH	6.5-8.5	7	6.8	6.8
2	Total dissolved solid (ppm)	500-2000	130	840	1900
3	Total Hardness (as CaCO <sub>3</sub> ) (ppm)	300-600	60	120	300
4	Fluoride (as F) (ppm)	1-1.5	Nil	Nil	Nil
5	Acidity	-	-	-	-
6	Alkalinity (ppm)	200-600	70.6	16.2	56.8
7	Iron (as Fe) (ppm)	0.3-1	0.3	0.3	0.5
8	Chloride (as chlorine) (ppm)	250-1000	33.75	160	289.6
9	Sulphites (as SO <sub>4</sub> ) (ppm)	200-400	Nil	20	160
10	Residual free chlorine (ppm)	0.2	Nil	Nil	Nil
11	Nitrate (as NO <sub>3</sub> ) (ppm)	45	2	Trace	-

**Table 5.21 Effect of CP on Effluent Water for S2 after Planting**

Sl. No.	Parameter that controls the quality characteristics	Range of Parameter as per Standard	Parameter of water used	Quality of soil after 3 months without planting	Quantity of water from the soil treated with 10% CP 3 months after planting.
1	pH	6.5-8.5	7	6	6.66
2	Total dissolved solid (ppm)	500-2000	130	650	2700
3	Total Hardness (as CaCO <sub>3</sub> ) (ppm)	300-600	60	160	124
4	Fluoride (as F) (ppm)	1-1.5	Nil	Nil	Nil
5	Acidity	-	-	-	-
6	Alkalinity (ppm)	200-600	70.6	7.8	19.2
7	Iron (as Fe) (ppm)	0.3-1	0.3	Trace	0.3
8	Chloride (as chlorine) (ppm)	250-1000	33.75	101	162.3
9	Sulphites (as SO <sub>4</sub> ) (ppm)	200-400	Nil	15	22
10	Residual free chlorine (ppm)	0.2	Nil	Nil	Nil
11	Nitrate (as NO <sub>3</sub> ) (ppm)	45	2	1	6

**Table 5.22 Effect of CP on Effluent Water for S3 after Planting**

Sl. No.	Parameter that controls the quality characteristics	Range of Parameter as per Standard	Parameter of water used	Quality of soil after 3 months without planting	Quantity of water from the soil treated with 10% CP 3 months after planting.
1	pH	6.5-8.5	7	7	5.8
2	Total dissolved solid (ppm)	500-2000	130	540	1840
3	Total Hardness (as CaCO <sub>3</sub> ) (ppm)	300-600	60	38	340
4	Fluoride (as F) (ppm)	1-1.5	Nil	Nil	Nil
5	Acidity	-	-	-	-
6	Alkalinity (ppm)	200-600	70.6	27.3	11.7
7	Iron (as Fe) (ppm)	0.3-1	0.3	.1	0.3
8	Chloride (as chlorine) (ppm)	250-1000	33.75	115	153.9
9	Sulphites (as SO <sub>4</sub> ) (ppm)	200-400	Nil	50	250
10	Residual free chlorine (ppm)	0.2	Nil	Nil	Nil
11	Nitrate (as NO <sub>3</sub> ) (ppm)	45	2	Trace	3

**Table 5.23 Effect of CP on Effluent Water for S4 after Planting**

Sl. No.	Parameter that controls the quality characteristics	Range of Parameter as per Standard	Parameter of water used	Quality of soil after 3 months without planting	Quantity of water from the soil treated with 10% CP 3 months after planting.
1	pH	6.5-8.5	7	6.8	6.3
2	Total dissolved solid (ppm)	500-2000	130	640	2900
3	Total Hardness (as CaCO <sub>3</sub> ) (ppm)	300-600	60	140	292
4	Fluoride (as F) (ppm)	1-1.5	Nil	Nil	Nil
5	Acidity	-	-	-	-
6	Alkalinity (ppm)	200-600	70.6	27.3	9.2
7	Iron (as Fe) (ppm)	0.3-1	0.3	.4	0.3
8	Chloride (as chlorine) (ppm)	250-1000	33.75	192	299.2
9	Sulphites (as SO <sub>4</sub> ) (ppm)	200-400	Nil	30	110
10	Residual free chlorine (ppm)	0.2	Nil	Nil	Nil
11	Nitrate (as NO <sub>3</sub> ) (ppm)	45	2	Trace	Trace

The results of chemical tests carried out on the effluent water which seeps through all the four soils for three months with out planting and with planting are presented in Tables 5.20 to 5.23. The tables give the range as per standards adopted for quality of water for the above eleven parameters.

All the four soils were treated with coir pith. Table 5.20 presents the results for soil S1. It can be seen that both results obtained without planting and with planting are with in the normal ranges. Similarly the results presented in table 5.21 for soil S2, table 5.22 for soil S3 and table 5.23 for soil S4 show that the parameters that govern quality of water are not affected by use of admixtures to enhance water holding capacity. How ever the total dissolved solids in case of soils S2 and S4 cross the upper limits marginally.

Thus the detailed chemical analysis carried out on the effluent water passing through the soil irrigated for 3 months without and with planting clearly indicate that amendment of soils with coir pith do not affect the chemical balance or fertility of the soil.

## **6.1 INTRODUCTION**

The most important object in irrigated agriculture is to minimize the utilization of applied water- the single most vital input for crop production.

As more and more food production is required with limited supply of water, timely irrigation with proper quantity of water is essential to achieve maximum benefit from the given quantity of water. Irrigation scheduling refers to the actual time or stage of the crop when the irrigation should be applied to replenish the soil water already consumed by plants before they are affected by the shortage of water.

How much water is to be added and when it is applied are decided to a larger extent by the geotechnical and physical properties of soil.

## **6.2 WATER HOLDING CAPACITY AND RELATIVE DENSITY OF SOIL**

The Seven Soils selected for the study covered a wide range with regard to textural classification within the ambit of soils used for farming activities in Kerala. While soil S2 has a fines content of 72%, soil S3 is virtually sand with a silt plus clay content as low as 6%. With this grain size distribution, the soil can be in a very loose condition with a low relative density of 0.2 or very dense when relative density is 0.7. How this will affect the water holding capacity of the soil was investigated in detail by determining the field capacity of all the seven soils with relative density 0.2, 0.3, 0.4, 0.5, 0.6 and 0.7. The numerous tests carried out clearly indicate that the relative density of soil does not influence the field capacity considerably. The variation in field capacity was just around 3% while the relative density increased from 0.2 to 0.7 an increase of 350%.



The in situ relative densities of all the seven soils were found out and they fall in a small range of 0.4 to 0.45. This value was made use, of in the preparation of soil specimens for further studies.

### **6.3 EVAPORATION LOSSES FROM SOIL**

As water is going to be more and more scarce and valuable, its retention by soil to support plant life is of paramount importance. Loss of water from soil is due to two factors - evaporation from surface and evapotranspiration through the plants. The former has been investigated in detail. It has been confirmed that higher contents of fines retain water for a larger duration. However the rate of evaporation loss, whether the soil is exposed to direct sun light or it is kept at room temperature, is more or less the same.

Eventhough fines in soil increases water holding capacity, its effect is not significant when the soil is directly exposed to sun light and at the initial stages of drying. The effect of fines is more pronounced when there is mulching.

### **6.4 FIELD CAPACITY AND PERMANENT WILTING POINT**

The advantages due to higher contents of fines have been studied in detail. The most salient parameter in the assessment of water holding capability of soils are Field Capacity (FC), Permanent Wilting Point (PWP) and Plant Available Water (PAW). It has been established clearly that all these parameters have a direct bearing on the percentage of fines in the soil. Eventhough these values can be accurately determined using the Pressure Plate Apparatus, the values can be obtained from the percentage fines also with adequate accuracy. The following correlations have been obtained from the results of a series of tests on the seven soils selected.

$$FC = 0.3F + 15.74$$

with a correlation coefficient of 0.92

where FC = Field Capacity (%)

F = fines content (%)

$$\text{PWP} = 0.18 F + 5.75$$

with a correlation coefficient of 0.91

where

$$\text{PWP} = \text{Permanent Wilting Point (\%)}$$

$$F = \text{fines content (\%)}$$

Similarly

$$\text{PAW} = 0.12 F + 7.89$$

with a correlation coefficient of 0.91

where PWA = Plant Available Water (%)

$$F = \text{fines content (\%)}$$

These equations will come handy while estimating Filed Capacity, Permanent Wilting Point and Plant Available Water in field, without the use of sophisticated laboratory equipments.

## **6.5 WATER USE EFFICIENCY AND IRRIGATION INTERVAL**

The classical question involved in irrigation management are “when to irrigate” and “how much to irrigate”. Since the water available for irrigation is fixed, for better water use efficiency (WUE), the irrigation interval should be increased to the maximum extent possible and water supply just sufficient to saturate the soil fully to bring the water content above the field capacity. Once the field capacity is estimated with the above equation, the water to be supplied can be estimated.

The plots between water content and time when soils are exposed to direct sun light and room temperature will help us to estimate the irrigation intervals. The minimum water content that should be available is estimated as the sum of PWP, a minimum reserve moisture content selected based on the sensitivity of the plant to draught and a leaching fraction of say 10-20%. The number of days taken from the water content Vs time curves will help to arrive at the irrigation interval to suit the conditions that exist in field.

From the results of the evaporation studies, equations for water content Vs time curves can be obtained. Typical equations for silty clay loam soil like S2 and sandy soil like S3 can be obtained respectively as

$$w = 0.84 t^2 - 2.908 t + 38.99$$

with R = 0.986

$$w = 0.07 t^2 - 2.304 t + 21.6$$

with R = 0.987

where

w= water content (%)

t=time of evaporation (days)

Thus a procedure has been formulated to achieve the maximum water use efficiency for such soils.

## **6.6 HYDRAULIC CONDUCTIVITY**

Hydraulic conductivity has great relevance in irrigation as it controls the aeration and the saturated and unsaturated flow through the soil. From a series of permeability tests, a relation between k and fines content was established as

$$k = 0.0008 e^{-0.59F}$$

with a correlation coefficient of 0.98

where

k = the permeability of the soil (cm/sec.)

F = fines content (%)

## **6.7 NUTRIENT VALUES OF SOILS AND QUALITY OF WATER**

Of the thirteen essential elements in soils, N,P, K, Ca, Mg and S are called macronutrients as they are needed in large quantities. Chemical analysis has been done in great detail to check whether the chemistry of soil is affected by flow of water for about three months. The effect on values of Organic content, N, P, K, Ca, P and cation exchange capacity is negligible.

Water used for irrigation was analysed for pH, total dissolved solids, total hardness, Fluoride, acidity, alkalinity, Iron, Chlorides, Sulphate and Nitrate. The water that seeps out of the soils after about three months was also analysed for the above parameters. The characteristics of the water supplied and water that seeps through the soils showed some changes in values. This indicates that the water that is used for irrigation and water that reaches the root system can be different.

## **6.8 STUDIES ON SOILS TREATED WITH ADMIXTURE**

Water use efficiency can be considerably improved if the water is retained for a longer duration by the soil. The soil can be amended by the addition of suitable admixtures.

Selection of an admixture should take into consideration the soil texture, porosity, organic content, moisture condition, nutrient content and rapid fermentation process of the admixture. Here the admixtures chosen were byproducts of coir industry - coirpith and coir pith compost and in addition vermi compost. The abundant availability of coirpith, which leads to pollution problems can be taken advantage of, due to its phenomenal water holding capacity which is over 600%.

Eventhough coirpith is excellent in this respect, it has a high C:N value 112 :1 which resists microbial degradation. Coirpith compost with a C:N ratio 24:1 is more amenable in this respect.

Coirpith and coir pith compost have field capacity of 556.2% and 174.2% and PWP of 302.75% and 114.48% respectively. Obviously they can contribute significantly to the retention of water in soil.

### **6.8.1 Soil Treated with Coir Pith**

The improvement in water retention when coir pith is used as an admixture has been categorically proved by the results presented by the tables and figures earlier.

On addition of 10% of coir pith, field capacity increased from 20.25% to 54.71% (2.7 times) for soil S1. The increase in PAW was 168%. The water content Vs time curves show that for untreated soil S1, the steady state in water content is reached by 30 days whereas for treated soil, it is about 45 days. These figures clearly

show that coirpith as an admixture, improves both the water content and water retention characteristics of the soil.

The PAW which was 11.1% for soils S1 improved to 29.84% which is about 3 times as that of soil alone. Thus coirpith as an admixture improves the performance of all the soils but it is more effective in sandy soils compared to silty soils.

### **Improvement of Irrigation Interval with Coirpith**

When water content falls below the PWP, the plants start showing distresses. If the water holding capacity is higher irrigation interval can be longer.

A series of tests to study the evaporation loss with time has helped to formulate a procedure to design irrigation schedule for a treated soil. Water content Vs percentage of coirpith can be plotted for any fixed irrigation interval like 10, 20 or 30 days. For soil S<sub>1</sub> correlations have been obtained as shown below:

$$w = 3.457CP + 12.7 \quad (R = 0.992) \text{ for 10 days}$$

$$w = 3.215CP + 6.256 \quad (R = 0.993) \text{ for 20 days}$$

$$w = 2.805CP + 1.966 \quad (R = 0.994) \text{ for 30 days}$$

where

CP = the percentage of coirpith

w = the water content

Since the minimum permissible water content is known, for a specific irrigation interval, we can select the percentage of coirpith to be added to the soil S<sub>1</sub>.

Thus a design procedure has been established using the parameters- field capacity, irrigation interval and percentage admixtures.

Similar equations have been established for other soils S<sub>2</sub>, S<sub>3</sub> and S<sub>4</sub> also, which will help to arrive at the correct percentages of coirpith to be added.

### **6.8.2 Soil Treated with Coir Pith Compost**

The disadvantage of the higher C:N ratio of 112.:1 in coir pith has been brought down to 24:1 in coirpith compost which can claim an additional advantage of manure content.

Additional of 10% of coirpith compost to soil S1 increases the field capacity from 20.25% to 42.77% which is an improvement of 100%. PAW improves from 11.11% to 23.75% which again is more than 100%.

Correlations could be developed for selecting the correct percentage coirpith compost as given below:

$$w = 2.33 CC + 16.20 \quad (R = 0.954) \text{ for 10 days}$$

$$w = 2.015CC + 11.74 \quad (R = 0.892) \text{ for 20 days}$$

$$w = 1.668CC + 7.022 \quad (R = 0.885) \text{ for 30 days}$$

where  $w$  = water content (%)

$CC$  = Percentage of coirpith.compost

Similarly equation have been developed for soils S2, S3 and S4 which will help to arrive at the percentage of coirpith compost for any water content and irrigation interval as in coirpith.

### **6.8.3 Soil Treated with Vermi Compost**

Unlike the first two admixtures, where water retention was given the top priority, the main attraction in the use of the third one was to study how a farm manure influenced the retention characteristics of the soils. Compared to the C:N ratio of 112:1 in coirpith and 24:1 in coirpith compost, vermi compost has a comparatively low C:N ratio of 14:1.

This is biodegradable and is equally efficient as a nutrient. Compared to the first two admixtures, vermin compost is not that effective even though it contributes to the enhancement in field capacity and plant available water, the improvement is erratic in contrast to the steady improvement shown by coirpith and coirpith compost.

## **6.9 ESSENTIAL ELEMENTS IN PLANT NUTRITION**

A mineral element is considered to be essential to plant growth and development if the element is involved in plant metabolic functions and the plant cannot complete its life cycle without the element. Of the sixteen elements the three elements carbon, hydrogen and oxygen are most abundant. Macronutrients N, P, K,

Ca, Mg and S have significant presence in soil. The seven micronutrient Fe, Zn, Mn, Cu, B, Cl and Mg show low concentration.

Plant growth may be retarded if these elements are actually lacking, in the soil, or they become available too slowly or they are not adequately balanced by other nutrients. Since this is significant, it has to be checked whether there are any drastic changes in the chemistry of the soil. Extensive chemical analyses were carried out on soil, soil treated with coirpith and soil in which plant growth was permitted for three months.

The results presented earlier show that N, P and K are not affected by addition of Coirpith. Other elements also are not affected by coirpith. However, the organic carbon registers an increase beyond normal values when higher percentages of coirpith are used in certain soils with high fines content. A ceiling of 5% is advised for coirpith in such soils.

Tests carried out on soils with coirpith compost and vermi compost do not show any adverse effects on the elements or nutrients present in soil.

## **6.10 EFFECT OF ADMIXTURES ON HYDRAULIC CONDUCTIVITY**

Hydraulic conductivity influences the FC and PWP values of the soils. Water content retained by the soil, when 0.3 bar and 15 bar pressures are applied for sufficient time by pressure plate apparatus, the values of field capacity and permanent wilting point are obtained. Since these two are the most important parameters in water retention studies, study of hydraulic conductivity of soil with and without admixtures is very relevant.

Through a series of permeability tests, it has been shown that the admixtures do not have any adverse effect on permeability or aeration.

## **6.11 EFFECT OF ADMIXTURES ON PLANT GROWTH**

To study the effect of admixture on plant growth, detailed chemical analyses were conducted on all the four soils, treated with coirpith on application of admixture and three months after the plants were allowed to grow.

The values of pH, organic carbon, cation exchange capacity N, P, K and Ca were determined for various percentage of coir pith through a series of detailed chemical analyses.

It can be found from the investigations, that the chemical properties of soil or water are not affected adversely by the addition of coir pith.

The three admixtures do not affect the soil water after three months of application or after three months of planting.

Retention of water by soil is the major factor which improves water use efficiency and the findings will be helped in promoting the efficiency of water utilization.



---

## REFERENCES

---

- Anabayan , K., and Palaniappan, P., (1990). “Effect of Coir pith composed by hydrophilic polymer in combination with fertilizer application and Azospirillum inoculation on soil moisture growth and yield and rainfed sorghum”, Indian Journal of Agronomy and crops, Vol.166 ,pp.112-116.
- Ananthanarayana, R., and Ravindran , M.R., (1999). “Soil tests for available phosphorous and their relation with inorganic P fractions in Acid soils of Karnataka”, Journal of Indian Society of Soil Science, Vol. 47, No. 2, pp. 283-287.
- Anil, R., C., Challa, O., and Sehgal, J., (1999). “Moisture stress during the growth period of sorghum in a micro water shed”, Journal of Indian Society of Soil Science, Vol. 47, No. 3, pp 405-410.
- Anil, R., Chinchmalatine, G., Rao, G., Nayak, A.K., and Varma, A. K., (2006). “Swell-shrink potential of vertisols in relation to clay content and exchangeable sodium under different ionic environment”, Journal of Indian Society of Soil Science , Vol. 54, No. 4, pp .1-5.
- Bachmann, J., and Vander Ploeg., R.R., (2002). “A review of recent developments in soil water retention theory: Interfacial tension and temperature effects”, Journal of Plant Nutrition Soil Science, 165, pp. 460-478.
- Bachmann, J., Hartzon, R., Grand, S.A., and Vander Ploeg., R.R., (2002). “Temperature dependence of water retention curves for wettable and water repellent soils”, American Journal of Soil Science Society, 66, pp.44-52.
- Bandyopadhyay, S.K. and Ray, S.B. (1988): “Changes in some physical properties of sandy loam soil as influenced by Jalsakthi”, Indian Journal of Agronomy, vol. 33, No. 4, pp. 447-450.
- Bharadwaj, A.K., Goldstern, D., Ley, G.J., Shainberg, I., and Warrington, D.N., (2007). “Water retention and hydraulic conductivity of cross-linked

- polyacrylamids in sandy soils”, American Journal of Soil Science Society, 71, pp.406-412.
- Bhardwaj, R.M (2005) “Water quality monitoring in India – achievements and constraints” IWG-Env, International Work Session on Water statistics, Vienna.
- Bharmaha, P.R., Oza, S.R., Jadhav, G.S., and Shelke, D.K., (1999). “Effect of different irrigation layouts on soil plant – water relationship and water use efficiency of sunflower”, Journal of Indian Society of Soil Science , Vol. 47, No. 3, pp .396-400.
- Brady, K. C. (1988). “ Soil suction and the critical state”, Geotechnique, 38 (1), pp.117-120.
- Brady, N. and R. Weil. (2002) “ The Nature and Properties of Soils” 13<sup>th</sup> Edition. Prentice Hall. Upper Saddle River. New Jersey, 960 p.
- Brankensiek, D.L., Rawls, W.J., and Saxton, K.E., (1982). “Estimation of soil water properties”, Journal of American Society of Agricultural Engineers, Vol. 25, No. 5, pp. 1316-1328.
- Buckman and Brady, (1998). “The nature and properties of soils”, Eurasia Publishing House Pvt. Ltd., Ram Nagar, New Delhi – 1
- Cogle. A.L., George, D.J., Jagawad, L.S., and Padmanabhan, M.V., (1992). “On farm evaluation of land treatments to increase infiltration and crop yield on shallow vertical soil”, Journal of Soil Water Conservation India, Vol. 36 (3 & 4), pp.181-187.
- Das, M., and Singh, R.,(2001) . “Evaporativity and insitu hydraulic functions of some soils”, Indian Journal of Soil Conservation, 29(1), pp.26-32.
- Dekker, L.W., Ritsima, C.J., Oostindic, K., and Boersma, O.H., (1998). “Effect of drying temperature on the severity of Soil water repellency”, American Journal of Soil Science Society, 163, pp.780-796.
- Devaraj , G., (1991). “Coir pith to increase Sugarcane yield in the tannery effluent affected soil”, Proceedings of seminar on – Utilization of coir pith in agriculture , Tamilnadu Agricultural University” , pp. 122-128.

- Dhale, S.A., Prasad, J., Patil, N.G., and Srivastava, R., (2009). “Estimation of water retention characteristics of shrink-swell soils using Pedo transfer functions”, *Journal of Indian Society of Soil Science* , Vol. 57, No.3, pp .273-279.
- Fredland, D.G., Fredland, M.G., and Wilson, G.W.,(1998). “Estimating unsaturated soil properties using a knowledge base systems”, *Proceedings of Second International Conference of Unsaturated Soils, UNSAT 98 Beijing, Aug*, pp.17-30.
- Fredlund, D.G., and Xing, A.,(1994). “Equations for the soil –water characteristic curve”, *Canadian Geotechnical Journal*, 31(3), pp. 521-532.
- Gajbhiye, K.S, (19.0). “Water retention in vertisols and their intergrades as influenced by the physicochemical properties”, *Journal of Indian Society of Soil Science*, Vol. 38, pp. 524-527.
- Geetha Divakar and Geetha Karthi A. (2008). “Spatial and seasonal variation of surface water quality in Pillavakkal irrigation system”, *Pollution Research Journal* 27, pp. 77-82.
- GenchtenVan, M., Th., Singh, V.P., and Jain, S.K., (2004). “Analysis of soil water retention data using artificial neural network”, *Journal of Hydraulic Engineering- ASCE*, Sept- Oct, pp. 415-420.
- Genuchtenvan, M. Th., (1980). “A closed form equation of predicting the hydraulic conductivity of unsaturated soils”, *American Journal of Soil Science Society*, 44, pp. 890-898.
- Gopaldaswamy A., Rajkannan, R., Poongothai , S., and Natesan, R.,(1991) . “Efficiency of coir clust in comparison with pressmud and groundnut husk on physical property of soil”, *Proceedings of seminar on – Utilization of coir pith in agriculture , Tamilnadu Agricultural University* , pp. 151-156.
- Gourley, C.S., and Schreiner, H.D., (1995). “Field measurement of soil suction”, *Proceedings of the first International Conference on unsaturated soils, Paris, 2*, pp. 601-606.
- Gupta, H.S., Kundu, S., Bhattacharyta, R., Ved Prakash, and Srivastava, A.K., (2004).“Effect of long term manuring on soil organic carbon, bulk density

- and water retention characteristics under soyabean- wheat cropping sequence in North Western Himalayas”, *Journal of Indian Society of Soil Science*, Vol. 52, No. 3, pp. 238-242.
- Jain, K.C., Kumar, S. and Nachiappan, P. (1993). “Soil moisture uptake by plants – A review”, *Hydrology Journal*, Vol. XVI, No. 182, Indian Association of Hydrologists, Roorkee, pp. 77-86.
- Jalota, S.K., (1990). “Suitability of techniques for predicting falling rate stage evaporation relation to soil type and evaporativity”, *Journal of Indian Society of Soil Science*, Vol. 38, pp. 380-384.
- Jaramillo, D.F., Dekker, L.W., Ritsima, C.J. and Henchicks, J. M. H., (2000). “Occurrence of soil water repellency on arid and humid claimtes”, *American Journal of Hydraulics*, 231 & 232, pp. 105-111.
- Kondo, K., Inosako, R., Zhang, C.T., Ahmed, O., Inoue, M., and Saxena, M.C. (2009). “Effect of mulching on evaporation , yield and water use efficiency on Swiss cheet irrigated with diluted sea water”, *Journal of Food , Agriculture and Environment*, Vol.7,(3 &4), pp.650-654.
- Krishnamoorthi , V.V, Subramanion, K.S , Selvakumar, G and Chinna swami, K.N (1991). “Influence of composted coir pith in redsoil with sunflower” . *Proceedings of seminar on utilization of coir pith in agriculture*, 20<sup>th</sup> November at Tamilnadu Agricultural University, Coimbatore . pp 159-162.
- Kumar, C.P., (1999). “Variation of soil moisture characteristics in part of Hendon River Catchment”, *Technical Report-National Institute of Hydrology*, Roorkee, pp. 61.
- Kumar, S., Sharma, J.C, and Sharma, L.P. (2002). “Water retention characteristics and erodibility indices of some soils under different land uses in North-West Himalayas”, *Indian Journal of Soil Conservation*, Vol. 30(1), pp. 29-35.
- Kumar,C.P. and Seth, S.M (2001). “Derivation of soil moisture retention characteristics from saturated hydraulic conductivity”, *Journal of Indian Society of Soil Science*, Vol. 49, pp. 653-657.

- Lakaria, B.L., Muralidharudu, Y., Singh, K.V., and Subhi Rao, A., (2009). "Soil testing and nutrient recommendation", *Journal of Indian Society of Soil Science* , Vol. 57, No.4, pp .559-571.
- Leeper, G W & Uren, N C (1993) "Soil Science , an Introduction" 5<sup>th</sup> Edition , Melbourne University Press, Melbourne.
- Madhumita, D., and Singh, R., (2001). "Evaporativity and in situ hydraulic functions of some soils", *Indian Journal of Soil Conservation*, 29(1), pp. 26-32.
- Manickam, T.S., Nagarajan, R., Kothandaraman, G.V., Ramaswamy, K., and Palaniswamy, G.G., (1985) . "Manurial value of coir pith", *Madras Agriculture Journal*, 72, pp.533-535.
- Mc Cauley, A., Jones, C. and Jacobsen, J. (2005): "Soil and water management module 1 – Basic soil properties", Montana State University Extension Service, Bozeman.
- Michael A.M. (1999). "Irrigation theory and practices", South Asia Books, New Delhi.
- Namasivayam, C., and Sangeetha, D.,(2006). "Studies using Coir pith to develop Zinc chloride activated carbon and applied for the removal of toxic from water", *Indian Journal of chemical technology*, Vol.12, pp.513-521.
- Natesan, R., and Mathan, G., (1990). "Effect of soil compaction on strength and productivity of clay soil", *Journal of Indian Society of Soil Science*, Vol. 38, pp. 385-388.
- Neena, M.C., and Vadev, R.L.,(2009). " Avalibale micro nutrients status and their relationship with soil properties of Degana Soil Series Rajasthan", *Journal of Indian Society of Soil Science* , Vol. 57, No.1, pp .90-92.
- Nourbakhsh, F, Abbaspour K C and Schulin R (2005). "Estimation of field capacity and wilting point from basic soil physical and chemical properties", *Arid Land Research Management*, Vol-19, pp-81-85(5).
- Patnaik, S.N., and Sanu, C., (1990). "Influence of lime and organic matter on pH and ion exchange phenemenon of some Alfisols", *Journal of Indian Society of Soil Science*, Vol. 38, pp. 389-393.

- Penzoni, G, and Marchetti, R. (2006). "Green manuring influence on soil water retention", *Geophysical Research Abstracts*, Vol. 8, 07304.
- Prabhakara Shetty, T.K., Indires, K.M., and Uthiah, B.C., (1993). "Preliminary studies in the effect of mulches and irrigation in the growth of young coconut plants in coastal Karnataka", *Indian Konkan Journal*, 24(6) , pp. 5-9.
- Purandara,B.K and Kumar,C.P (2003). "Hydrologic characteristics of soils under different land covers in Gataprabha Basin", *IE (I) Journal – CV Vol. 84*, pp.1-5.
- Rajarathnam,S and Shashirekha,M.N (2007). "Bioconversion and biotransformation of coir pith for economic production of *Pleurotus florida*: chemical and biochemical changes in coir pith during the mushroom growth and fructification" *World journal of Microbiology and biotechnology*, Vol. 23, pp 1107 to 1114.
- Rajkai ,K. and Patil N U (2004). "Estimating the water retention curve from soil properties: comparison of linear, nonlinear and concomitant variable methods", *Soil and Tillage Research*, Vol. 79, pp. 145-152.
- Ramaswamy, P.P., and Son, T.T.N., (1993) . "Enrichment of coir reinforcement with macro and micro nutrients", *Proceeding of National seminar on Development in Soil Science*", Indian Society of Soil Science, New Delhi, pp.66-67.
- Rani Perumal, Santhi, R., and SelvaKumari, G., (1999). "Soil test based fertilizers recommendations under integrated plant nutrition system of rice pulse cropping sequence", *Journal of Indian Society of Soil science*", Vol. 47, No. 2, pp. 288-294.
- Rathft, L F, Ritchie, J.T and Cassel D. K (1983) "Field measured limits of soil water availability as related to laboratory measured" *Jr. of American Soil Science Society* Vol.47 770-775
- Rawls , S.W J, Brakensick, D.L and Saxton , K.E (1982): "Estimation of soil water properties", *American Science of Agricultural Engineering (ASAE)*, paper 81-2510.

- Richards, L.A., and Milton, F., (1943). "Pressure plate apparatus for measuring moisture sorption and transmission by soils", *Soil Science*, 56(5), pp. 395-404.
- Rogers, D.H. and Sothers, W.M., (1996). "Soil, water and plant relationships", Cooperative Extension Service, Manhattan, Kansas.
- Savitri,P and Khan, H.H.,(1994). "Characteristics of coconut coir pith and its utilization in agriculture", *Journal of Plantation Crops*, Vol. 22(1) pp. 1-18.
- Shah, Paresh, H., Sreedeeep, S., and Singh, D.N., (2006). " Evaluation of methodologies used for establishing soil-water characteristic curve", *Journal of ASTM International*, 3(6),
- Sharma R.B and Verma , G.P (1972) Moisture retention characteristics of some important soils of Madhya Pradesh in relation to their Physico-chemical properties. *Jr. of Indian Forester* 98 pp 22-29.
- Sharma, R.A., Upadhyay, M.S., and Tomer, R.S., (1998) . "Water use efficiency of some rain fed crops grown in vertisol as influenced by soil and straw mulching", *Journal of Indian Society of Soil Science* , Vol. 33, pp .387-391.
- Shirgure, D.S., Srivatsava, A.K., and Singh, S., (2001). "Effect of drip, microjets and basin irrigation methods on growth , soil and leaf nutrient change in acid lime", *Indian Journal of Soil Conservation*, 29(3), pp.229-234.
- Singh, D.N., and Kuriyan, S.J., (2003). "Estimation of unsaturated hydraulic conductivity using soil suction measurements obtained by insertion tensiometer", *Canadian Geotechnical Journal*, 40(2), pp. 476-483.
- Singh, D.N., Kuriyan, S.J., and Madhuri, V., (2001)."Application of a geotechnical centrifuge for estimation of unsaturated soil hydraulic conductivity", *Journal of Testing and Evaluation*, ASTM., 29(6), pp. 556-562.
- Singh, S, (2002). "Irrigation scheduling to crops under adequate and limited water supply situations", *Water Technology Centre, Indian Agricultural Research Institute, New Delhi*, pp.25-33.
- Singh, S., and Singh, N.P., (1991). "Response of wheat to irrigation und shallow and deep ground water situations", *Indian Journal of Agronomy* , 36,pp.189-193.

- Siva Samy, R and Suganya, S (2006) "Moisture retention and cation exchange capacity of sandy soils as influenced by soil additives" *Jr. of Applied Science Research* , 2 (11): 949-951
- Sreedeeep, S., and Singh, D.N., (2005)."A study to investigate influence of soil properties on its suction", *Journal of Testing and Evaluation, ASTM.*, 31(1), pp. 579-584.
- Sreedeeep, S., and Singh, D.N., (2006). "Methodology for determination of osmotic suction of soils", *Geotechnical and Geological engineering*, 24(5), pp. 1469-1479.
- Sreedeeep, S., and Singh, D.N., (2006). "Nonlinear curvefitting procedures for developing soil water characteristic curve", *Geotechnical testing Journal*, Vol. 29, No.5.
- Stroonsnijder, L, (1987). "Soil Evaporation: test of a practical approach under semi-arid conditions", *Netherland Journal of Agricultural Science*. Vol-5, pp-41-426.
- Subbaiah, R (1996). "Development and validation of a simple soil moisture status model", *Hydrology Journal*, Vol. XIX(1), pp. 19-31
- Sushil Kumar , J.C, Sharma and I.P Sharma (2002) "Water retention characteristics and erodibility indices of soma soils under different land use in North- west Hemalayala" *Indian Jr. of Soil Cons.* 30 (1) pp- 29-35.
- Thakur, V.K.S., Sreedeeep, S., and Singh, D.N., (2006). "Laboratory investigation on extremely high suction measurements for fine-grained soils", *Geotechnical and Geological engineering*, 24(3), pp. 565-578.
- Thakur, V.K.S., Sreedeeep, S., and Singh, D.N.,(2008). "Parameters affecting soil water characteristic curves of fine grained soil", *Journal of Geotechnical and Geoenvironmental Engineering- ASCE* , 131(4), pp.521-524.
- Van Genuchten, M.T., (1980). "A closed form equation for predicting the hydraulic conductivity of unsaturated soils", *Soil Science Society of America*, 44, pp. 892-898.



---

## **LIST OF PUBLICATIONS**

---

Based on the work reported in this thesis the following papers have been published.

1. 2006 “Water Management on Agricultural Soils”, Second National Conference on Recent Advances in Civil Engineering at Cochin, pp. 205 – 208
2. 2006 “Water Retention Characteristics of Agricultural Soils”, Proceedings of the Seventh National Conference on Technological Trends, 17-18 November at College of Engineering Trivandrum, pp. C134 – C138
3. 2007 “Study on Water Retention Characteristics of Soils”, 19<sup>th</sup> Kerala Science Congress at Kannur, pp. 880 – 881.
4. 2010 “Effect of Coir Pith on Soil Water System”, Proceedings of the International Conference on Materials Mechanics and Management, College of Engineering Trivandrum, 14-16 January, pp. 464 – 471