

SYNTHESIS AND TRANSFORMATIONS OF A FEW NITROGEN AND OXYGEN HETEROCYCLES

THESIS SUBMITTED TO
COCHIN UNIVERSITY OF SCIENCE AND TECHNOLOGY

IN PARTIAL FULFILMENT OF THE REQUIREMENTS
FOR THE DEGREE OF

DOCTOR OF PHILOSOPHY

IN THE FACULTY OF SCIENCE

IN

CHEMISTRY

BY

JOHN P. R.

UNDER THE SUPERVISION OF

Dr. S. PRATHAPAN



**DEPARTMENT OF APPLIED CHEMISTRY
COCHIN UNIVERSITY OF SCIENCE AND TECHNOLOGY
KOCHI -682 022
KERALA, INDIA**

JUNE 2010

***** *Dedicated to my **Parents and Teachers***

DECLARATION

I hereby declare that the matter embodied in the thesis entitled *“Synthesis and Transformations of a few Nitrogen and Oxygen Heterocycles”* is the result of genuine investigations carried out by me under the supervision of **Dr. S. Prathapan**, Associate Professor of Organic Chemistry, Department of Applied Chemistry, Cochin University of Science and Technology, Kochi-22, and the same has not been submitted elsewhere for the award of any other degree.

Kochi-22
June 21, 2010

John P. R.

**Department of Applied Chemistry
Cochin University of Science and Technology
Kochi -682 022, India**

Dr. S. Prathapan
Associate Professor



Phone: 0484-2575804
prathapan@cusat.ac.in

CERTIFICATE

This is to certify that the thesis entitled "*Synthesis and Transformations of a few Nitrogen and Oxygen Heterocycles*" is a genuine record of research work carried out by Mr. John P. R., under my supervision, in partial fulfilment of the requirements for the degree of Doctor of Philosophy of Cochin University of Science and Technology, and further that no part thereof has been presented before for the award of any other degree.

Kochi-22
June 21, 2010

Dr. S. Prathapan
(Supervising Guide)

Acknowledgements

*It is with great respect and immense pleasure that I express my sincere gratitude and obligation to my teacher and research supervisor **Dr. S. Prathapan**, Associate Professor of Organic Chemistry, Department of Applied Chemistry, Cochin University of Science and Technology, for his inspiration, guidance and providing me such a great opportunity for scientific research.*

I am thankful to Prof. K. Sreekumar, HOD, Department of Applied Chemistry, CUSAT and former HODs Dr. S. Sugunan, Dr. M. R. Prathapachandrakurup and Dr. K. Girish Kumar for providing me the necessary facilities for carrying out my research work.

My thanks are also due to,

- *Dr. P. A. Unnikrishnan and Dr. N. Manoj for their concern and support at various stages of the work.*
- *All the teaching and non-teaching staff of the Department of Applied Chemistry, for their help and support.*
- *Dr. T. N. Guru Row, IISc, Bangalore and Dr. Nigam P. Rath, University of Missouri, USA, for single crystal X-ray analysis.*
- *Dr. P. S. Parameswaran, NIO, Goa, and Dr. P. R. Rajmohan, NCL, Pune, for NMR analysis.*
- *Technical staff, SAIF, CUSAT, for NMR, GCMS and CHN analyses.*
- *Dr. Rajeev S. Menon, Dr. Suja T. D. and Dr. Samith K. M. for various analyses and literature collection.*
- *My seniors, Dr. Jean, Dr. Vidhya, Dr. Rekha, Dr. Ambili and Dr. Roshini for their timely involvement in the work.*
- *Ms. Gisha George and Mr. Jayakumar K. for their help and support.*

- *Eason M. Mathew for proofreading corrections.*
- *My colleagues Mr. Jomon P. J., Ms. Sandhya R. Mr. Rakesh N., Ms. Reshma G. and all the other members of Organic group and friends from other groups for their endless support and help particularly during the last phase of the work.*
- *All the teaching and non-teaching staff of the Post-Graduate Department of Chemistry, Govt. Victoria College, Palakkad, for their boundless support and motivation.*
- *Council of Scientific and Industrial Research (CSIR), New Delhi, for research fellowship.*
- *Very special thanks to my **parents**, sister and brothers; and to my beloved wife Rosemary, for their endless support, serenity, and love.*
- *All my teachers for their guidance and blessings.*

*Above all, I thank **God Almighty** for His blessings.*

John P. R.

PREFACE

Heterocycles constitute one of the most important classes of organic compounds and are widely distributed in nature. They are vital for the existence of living beings. The range of application of heterocycles is very wide. Many of the known natural drugs as well as most of today's synthetic drugs contain heterocyclic residues. About half of the known organic compounds have structures that incorporate at least one heterocyclic component. Three out of twenty natural amino acids contain heterocyclic ring components; likewise, many essential vitamins i.e., vitamin B series and vitamin C also contain heterocyclic moiety. Besides the prevalent applications in biological sector, their potential is well employed in synthetic chemistry as well as in material science.

In view of the incredible potential exhibited by heterocycles, developing novel synthetic strategies for their construction became an area of great interest.

Recently 1,3-dipolar cycloaddition, introduced by Rolf Huisgen, has emerged as an efficient protocol for the construction of heterocycles. Even though there are several methods available for the synthesis of heterocycles, the real attraction towards 1,3-dipolar cycloadditions is the easiness of preparation of dipoles, the diversity in dipoles as well as the observed regio- and stereoselective nature of their addition to π -systems. Nowadays, 1,3-dipolar cycloaddition reactions are employed in almost every sphere of chemistry, including, material chemistry, medicinal chemistry, biochemistry, *etc.*

Above and beyond their synthetic applications, the mechanism of 1,3-dipolar cycloadditions has also been intensively studied. Concerted or stepwise is a fundamental question in 1,3-dipolar cycloaddition chemistry. Most of the evidences for concertedness are indirect. Huisgen developed a rationale for the concerted mechanism of this reaction. Contrary to this, Firestone proposed a two step diradical mechanism. Their conflicting arguments continued for decades and are finally settled in favour of concerted mechanism. Later, Huisgen

observed scrambling of stereochemistry as well as formation of unexpected products in a few 1,3-dipolar cycloadditions. He described them as exceptions and refused to generalise his observations. Theoretical studies carried out on 1,3-dipolar cycloadditions revealed that, both concerted and stepwise paths are allowed and in some cases they may be in close competition.

In this scenario, the thesis entitled “*Synthesis and Transformations of a few Nitrogen and Oxygen Heterocycles*” depicts our attempts to explore the synthetic potential of 1,3-dipolar cycloadditions for the construction of heterocycles as well as to probe the possible reaction mechanisms in 1,3-dipolar cycloadditions.

The thesis is organized in to four chapters. The first chapter briefly introduces 1,3-dipolar cycloadditions. The research problem is defined at the end of this chapter. The second chapter describes the synthesis of various nitrones selected as one of the 1,3-dipoles. The results of our investigations on dipolar cycloaddition reactions of nitrones with DBA are revealed in the third chapter. We demonstrated that, 1,3-dipolar *cycloaddition* reaction between nitrones and DBA is a stepwise reaction *via* zwitterionic intermediate. We also proved that the reaction between nitrones and DBA is an efficient method for the synthesis of pharmacologically as well as synthetically important 3(2*H*)-furanones and quinolines. The fourth chapter is an extension of our studies to azomethine imines. The major outcomes are given at the end of the thesis.

Each chapter of the thesis is as an independent unit and therefore the structural formulae, schemes and figures are numbered chapter wise. Barring one exception, all new compounds were fully characterized on the basis of their spectral and analytical data and single crystal X-ray analysis in a few cases. Relevant data for the characterization of novel compounds synthesised by us are reported. A comprehensive list of references is included at the end of each chapter.

List of Abbreviations

AcOH	: acetic acid
MeCN	: acetonitrile
Bn	: benzyl
bs	: broad singlet
<i>m</i> -CPBA	: <i>m</i> -chloroperbenzoic acid
D	: debye
DBA	: dibenzoylacetylene
DCE	: 1,2-dichloroethane
DCM	: dichloromethane
Et ₂ O	: diethyl ether
DC	: dipolar cycloaddition
DEPT	: distortionless enhancement by polarization transfer
d	: doublet
edg	: electron donating group
ewg	: electron withdrawing group
<i>E</i>	: entgegen
EtOH	: ethanol
FAB	: fast atom bombardment
FMO	: frontier molecular orbital
g	: gram
HOMO	: highest occupied molecular orbital
IR	: infrared
LUMO	: lowest unoccupied molecular orbital
MS	: mass spectrometry
mp	: melting point
MeOH	: methanol
Me	: methyl
mg	: milligram
mL	: millilitre
MO	: molecular orbital
m	: multiplet
NMR	: nuclear magnetic resonance
Nu	: nucleophile
ORTEP	: Oak Ridge Thermal Ellipsoid Plot Program
PMO	: perturbational molecular orbital
Ph	: phenyl
RT	: room temperature
s	: singlet
TMS	: tetramethylsilane
TS	: transition state
UV	: ultraviolet
Z	: zusammen

CONTENTS

		Page
CHAPTER 1	1,3-Dipolar Cycloaddition: A Short Introduction	1
1.1.	Abstract	1
1.2.	Introduction	1
1.3.	1,3-Dipole/ylide	6
1.3.1.	Classification of 1,3-Dipoles	7
1.3.1.1	Allyl Anion Type 1,3-Dipoles	8
1.3.1.2	Propargyl/Allenyl Anion Type 1,3-Dipoles	8
1.3.2	Nature of 1,3-Dipoles	11
1.3.3	Electronic Structure of 1,3-Dipoles	12
1.4.	1,3-Dipolarophiles	13
1.5.	Synthetic Applications of 1,3-Dipolar Cycloadditions	14
1.6.	Mechanistic Aspects	16
1.6.1	Solvent Effects	25
1.6.2.	Regioselectivity	26
1.6.3.	Diastereoselectivity	28
1.6.4	Stereospecificity- A Mechanistic Probe	29
1.6.5	Concerted to Two-Step Pathway	30
1.7.	Definition of the Problem	33
1.8.	Objectives	34

	1.9.	References and Notes	36
CHAPTER	2	Synthesis of Nitrones	45
	2.1.	Abstract	45
	2.2.	Introduction	45
	2.2.1.	General Methods for the Synthesis of Nitrones	49
	2.3.	Results and Discussion	52
	2.3.1.	Synthesis of <i>N</i> -Fluorenylidene- <i>N</i> -arylnitrones	52
	2.3.2.	Synthesis of <i>N</i> -Diphenylmethylene- <i>N</i> -arylnitrones	54
	2.3.3.	Synthesis of <i>N</i> -Phenylmethylene- <i>N</i> -arylnitrones	55
	2.3.4.	Synthesis of <i>N</i> -fluorenylidene- <i>N</i> -(2,6-dimethylphenyl)nitrone	56
	2.4.	Experimental Section	61
	2.5.	References	69
CHAPTER	3	1,3-Dipolar Cycloaddition Reactions of Nitrones	75
	3.1.	Abstract	75
	3.2.	Introduction	75
	3.3.	Results and Discussion	82
	3.3.1.	Reactions of <i>N</i> -Fluorenylidene- <i>N</i> -arylnitrones with DBA	84
	3.3.2.	Reactions of <i>N</i> -Fluorenylidene- <i>N</i> -arylnitrones with DBA in Refluxing Acetonitrile	88
	3.3.3.	Proposed Mechanism for the Reactions of Nitrones with DBA- A Stepwise Reaction	89
	3.3.4.	Hydrolysis of <i>N</i> -Fluorenylidene- <i>N</i> -arylnitrone-DBA Adducts	93

3.3.5.	Proposed Mechanism for the Hydrolysis of <i>N</i> -Fluorenylidene- <i>N</i> -arylnitronone-DBA Adducts	94
3.3.6.	Reactions of <i>N</i> -Diphenylmethylene- <i>N</i> -arylnitrones with DBA	96
3.3.7.	Hydrolysis of <i>N</i> -Diphenylmethylene- <i>N</i> -arylnitronone-DBA Adducts	97
3.3.8.	Reactions of <i>N</i> -Phenylmethylene- <i>N</i> -arylnitrones with DBA	99
3.3.9.	Reactions of <i>N</i> -Fluorenylidene- <i>N</i> -(2,6-dimethylphenyl)nitronone with DBA	101
3.3.10.	Winterfeldt's Experiment Revisited- A Word of Caution	102
3.3.11.	Conclusion	103
3.4.	Experimental Section	104
3.5.	References	115
CHAPTER 4	Synthesis and 1,3-Dipolar Cycloaddition Reactions of Azomethine Imines	121
4.1.	Abstract	121
4.2.	Introduction	121
4.3.	Results and Discussion	124
4.3.1.	Synthesis of <i>N</i> ^α -Fluorenylidene- <i>N</i> ^α -aryl- <i>N</i> ^β -cyanoazomethine Imines	125
4.3.2.	Synthesis of <i>N</i> ^α -Diphenylmethylene- <i>N</i> ^α -aryl- <i>N</i> ^β -cyanoazomethine Imines	128
4.3.3.	1,3-Dipolar Cycloaddition Reactions of <i>N</i> ^α -Fluorenylidene- <i>N</i> ^α -aryl- <i>N</i> ^β -cyanoazomethine Imines with DBA	129

4.3.4.	Proposed Mechanism for the 1,3-Dipolar Cycloaddition Reactions of Azomethine Imines with DBA	134
4.3.5.	1,3-Dipolar Cycloaddition Reactions of N^α -Diphenylmethylene- N^α -aryl- N^β -cyanoazomethine Imines with DBA	134
4.3.6.	1,3-Dipolar Cycloaddition Reaction of N^α -Fluorenylidene- N^α -(4-chlorophenyl)- N^β -cyanoazomethine Imine with DMAD	137
4.3.7.	Conclusion	138
4.4.	Experimental Section	139
4.5.	References	156
Outcome	1,3-Dipolar Cycloaddition—A Case Study	159
List of publications		165

Chapter 1

1,3-DIPOLAR CYCLOADDITION: A SHORT INTRODUCTION

1.1. Abstract

This chapter portrays the milieu for the present study. It reveals the prevailing concepts and uncertainties in 1,3-dipolar cycloaddition chemistry.

1.2. Introduction

Heterocyclic compounds are compounds having a cyclic structure with at least two different kinds of atoms in the ring, generally one is carbon and the most common heteroatoms present are nitrogen, oxygen and sulfur. Heterocyclic compounds with rings containing other heteroatoms are also known. The heterocyclic ring may contain one or more than one heteroatom which may be alike or unlike. Heterocyclic compounds may be composed of more than one ring of which at least one must be a heterocyclic ring. Heterocycles can be classified into two categories-aliphatic (saturated or unsaturated) and aromatic heterocycles (Figure 1.1).¹

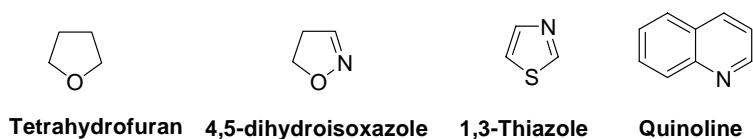

Figure 1.1

There is a rapid increase in the number, diversity as well as applications of heterocycles. Accordingly the literature on the subject is vast. Heterocycles are receiving more and more significance in recent years, particularly owing to their pharmacological as well as synthetic potential. Nature is the first and the largest producer of heterocycles. Heterocycles like *chlorophylls* and *heme* derivatives are responsible for the colour and texture of Nature (Figure 1.2). Similarly base pairs found in DNA and RNA, the genetic material of most of the living organisms, is also heterocycles (Figure 1.3). In conjunction with Nature's creation, chemists have artificially synthesized and tailored a number of heterocyclic compounds.

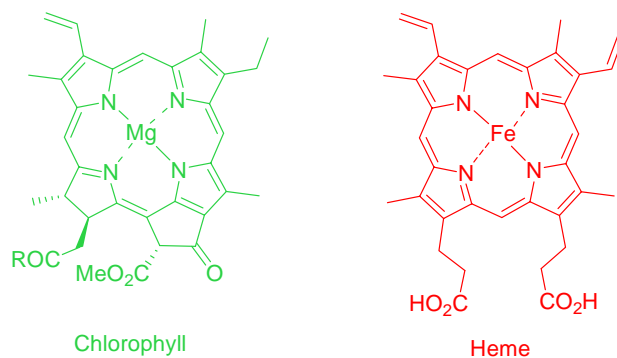

Figure 1.2

Many known natural drugs such as penicillin, quinine, papaverine, atropine, codeine, morphine, *etc.* as well as most of today's synthetic drugs such as rofecoxib, sulphadiazine, diazepam, chlorpromazine, barbiturates *etc.* are examples of heterocyclic compounds. Three out of twenty natural amino acids contain heterocyclic ring components and likewise many vitamins *e.g.*, vitamin B series and vitamin C also contain heterocyclic ring components. A number of useful materials like dyes, (*e.g.* indigo blue), luminophores, (*e.g.* acridine orange), pesticides, (*e.g.* diazinon), herbicides (*e.g.* paraquat), *etc.* possess heterocyclic rings (Figure 1.4).^{2,3}

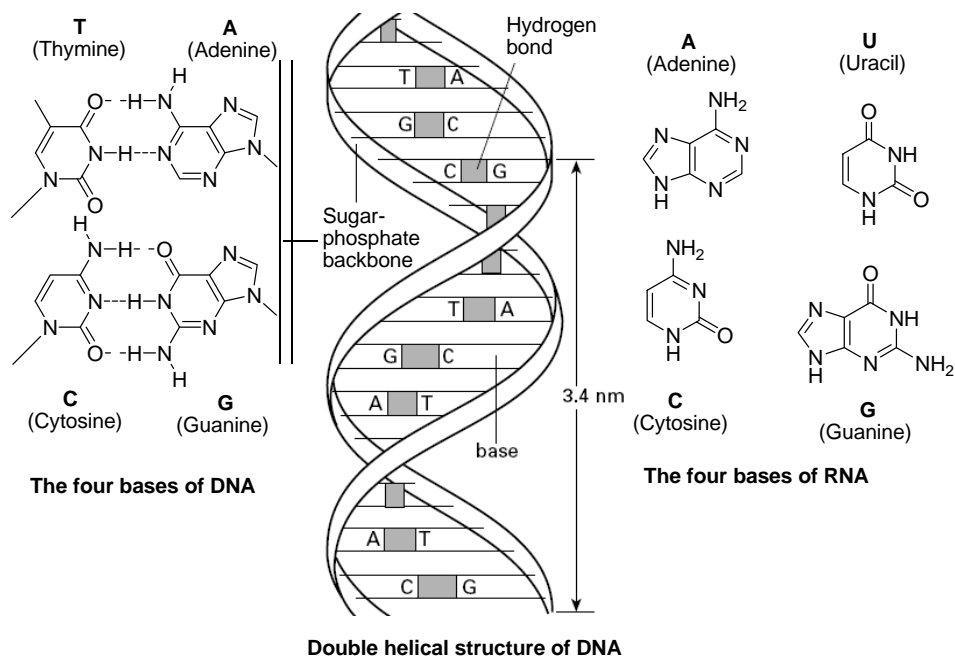

Figure 1.3

The rationale behind Nature's selection of heterocycles is perhaps due to the fact that they are chemically more flexible and able to respond to the demands of biochemical systems. The ability of many heterocycles to produce stable metalloheterocycles has immense biochemical significance (for *e.g.*, hemoglobin, chlorophyll, vitamins, enzymes, *etc.*). Introduction of heteroatoms into a carbocyclic compound makes a spectacular change in its chemistry and render it synthetically much more attractive. For instance, depending on *pH* of the medium, heterocycles may behave as acids or bases, forming anions or cations. Some interact readily with electrophilic reagents, others with nucleophiles, yet others with both. Some are easily oxidized, but resist reduction, while others can be readily hydrogenated but are stable towards the action of oxidizing agents. Certain amphoteric heterocyclic systems simultaneously demonstrate all the above mentioned properties. In

1,3-Dipolar Cycloaddition

addition to this, presence of heteroatoms brings tautomerism in heterocyclic series. Such a versatile reactivity is associated with the electron distribution within heterocyclic systems.⁴

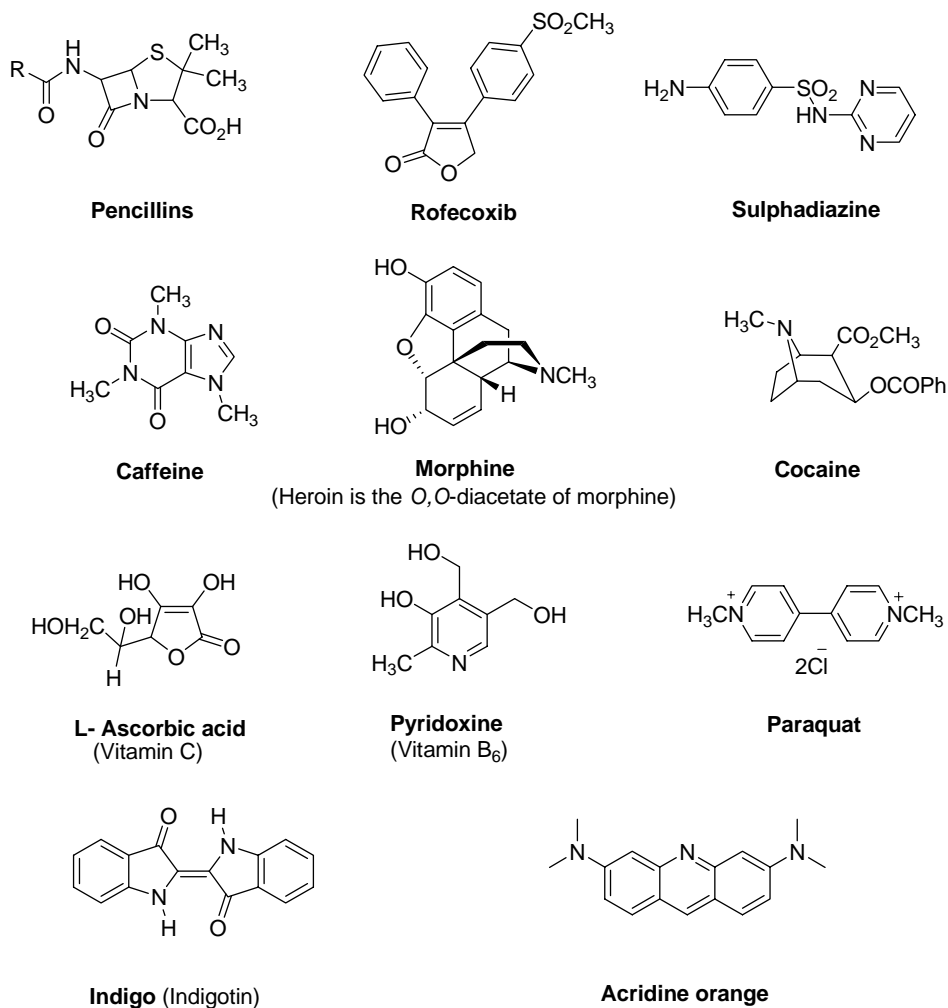

Figure 1.4

Obviously, all the above mentioned compounds are some of the nice examples of Nature's preference for heterocycles as well as compounds of practical interest. In view of this, it is of significant interest to synthesize

heterocyclic compounds and their derivatives. Various methods right now available for the synthesis of heterocyclic compounds can be grouped into the following three broad categories:-

1. Heterocycles *via* the modification of existing carbocyclic ring.
2. Cyclisation process leading to heterocycles.
3. Concerted cycloaddition reactions to furnish the required heterocyclic compounds.

Among these three methods, cycloaddition reaction involving two simple components appear to be an attractive choice for the synthesis of heterocyclic compounds.

Cycloaddition reaction is one of the most important classes of reactions in organic chemistry with both mechanistic and synthetic interest. Cycloaddition involves cyclic electron shifts. They are ring closure reactions in which the number of σ bonds increases at the expense of π bonds; generally two new σ bonds are formed. Within the class of cycloaddition, 1,3-dipolar cycloaddition reaction is widely used as a high yielding, efficient, regio- and stereoselective method for the synthesis of a variety of valuable five-membered heterocycles.

1,3-Dipolar cycloaddition reaction, where two organic molecules, a 1,3-dipole **I** and a dipolarophile **II** combine to give a five-membered heterocycle **III**, is one of the typical reactions in synthetic organic chemistry (Scheme 1.1). Starting from relatively simple and easily accessible molecules, 1,3-dipolar cycloaddition reaction can offer a wide variety of simple as well as complex heterocyclic compounds of primary importance for academic as well

1,3-Dipolar Cycloaddition

as industrial world. Accordingly this reaction is frequently used as a key step in several organic syntheses.⁵

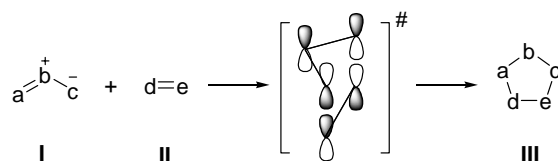

Scheme 1.1

1.3. 1,3-Dipole/ylide

The history of 1,3-dipoles starts with Curtius, who discovered diazoacetic ester in 1883.⁶ Five years later Buchner from Curtius' group studied the reactions of diazoacetic ester with α,β -unsaturated esters and he described the first 1,3-dipolar cycloaddition reaction. Buchner found that when methyl diazoacetate reacts with methyl acrylate the product isolated is 2-pyrazoline which is formed after the rearrangement of the initially formed unstable 1-pyrazoline (Scheme 1.2).⁷ At the same time, 1,3-dipolar cycloaddition reaction of diazoalkanes⁸ and alkyl azides⁹ were reported. Very shortly, Beckmann discovered azomethine oxides/nitrones.¹⁰ Nitrile oxides were discovered by Werner and Buss.¹¹ In 1938 Smith published the first review article on 1,3-dipolar cycloaddition reaction of nitrones, diazo compounds, and azides.¹² However, the scope of 1,3-dipolar cycloaddition reaction as a synthetic tool was limited, even the structure of the 1,3-dipoles and the products could not be properly assigned.

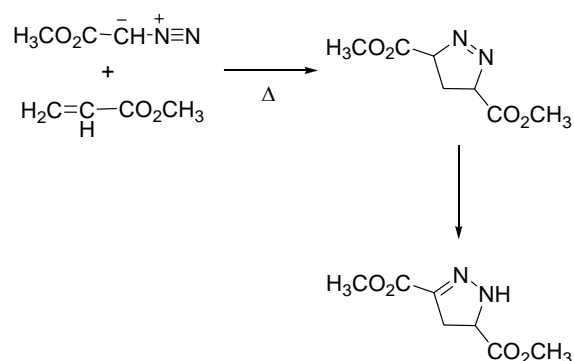

Scheme 1.2

Synthetic scope of 1,3-dipolar cycloaddition was established by Huisgen in the 1960s.⁵ The general concept of 1,3-dipolar cycloaddition reaction was formulated by Huisgen. He published a large number of research articles on 1,3-dipolar cycloaddition and gradually it became one of the standard methods for the preparation of five membered heterocycles. He classified 1,3-dipolar cycloaddition reactions and formulated the basic definitions.¹³

1.3.1. Classification of 1,3-Dipoles

The 1,3-dipole, also known as a ylide, is defined by Huisgen as an *a-b-c* structure, with a positive and a negative charge distributed over three atoms and has four π electrons.¹⁴ Huisgen categorized 1,3-dipoles into two general classes namely, allyl anion type and propargyl/allenyl anion type 1,3-dipoles. They are occasionally referred to as sp^2 and sp hybridized 1,3-dipoles respectively.

1.3.1.1. Allyl Anion Type 1,3-Dipoles

The allyl anion type 1,3-dipoles are characterized by the presence of four π electrons in three parallel p -orbitals perpendicular to the plane of 1,3-dipole and possessing a bent structure. Two resonance structures in which three centers have an electron octet, and two structures in which a or c has an electron sextet, can be drawn. The central atom b can be nitrogen, oxygen or sulfur (Scheme 1.3).

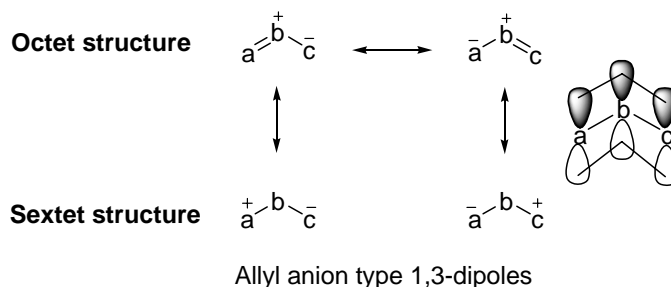

Scheme 1.3

1.3.1.2. Propargyl/Allenyl Anion Type 1,3-Dipoles

The propargyl/allenyl anion type has an extra π bond in the plane perpendicular to allyl anion type molecular orbital and the former orbital is for that reason not directly involved in resonance structures as well as reactions of 1,3-dipoles. Usually, the occurrence of this extra π bond makes 1,3-dipoles of propargyl/allenyl anion type linear. Generally, the central atom b is limited to nitrogen (Scheme 1.4).

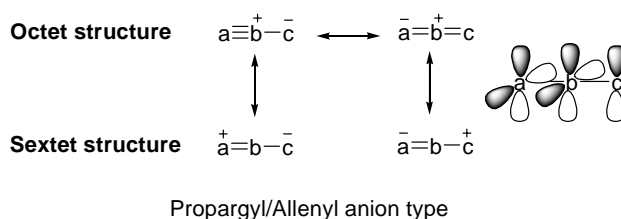

Scheme 1.4

1,3-Dipoles consist of mainly elements from group 14, 15, and 16. Since the parent 1,3-dipoles composed of elements from second row, and considering the above limitations on the central atom of dipole, a limited number of structures can be formed by permutations of nitrogen, carbon, and oxygen. As a result twelve dipoles of the allyl anion type (six of them have nitrogen function as middle center *b* and remaining six with oxygen atom as the middle center *b*) and six dipoles of the propargyl/allenyl anion type are obtained. The classification of 1,3-dipoles is shown in Table 1.1a and Table 1.1b. Higher row elements such as sulfur and phosphorus can also be introduced in 1,3-dipoles.

Table 1.1a.

Allyl anion type 1, 3-dipoles

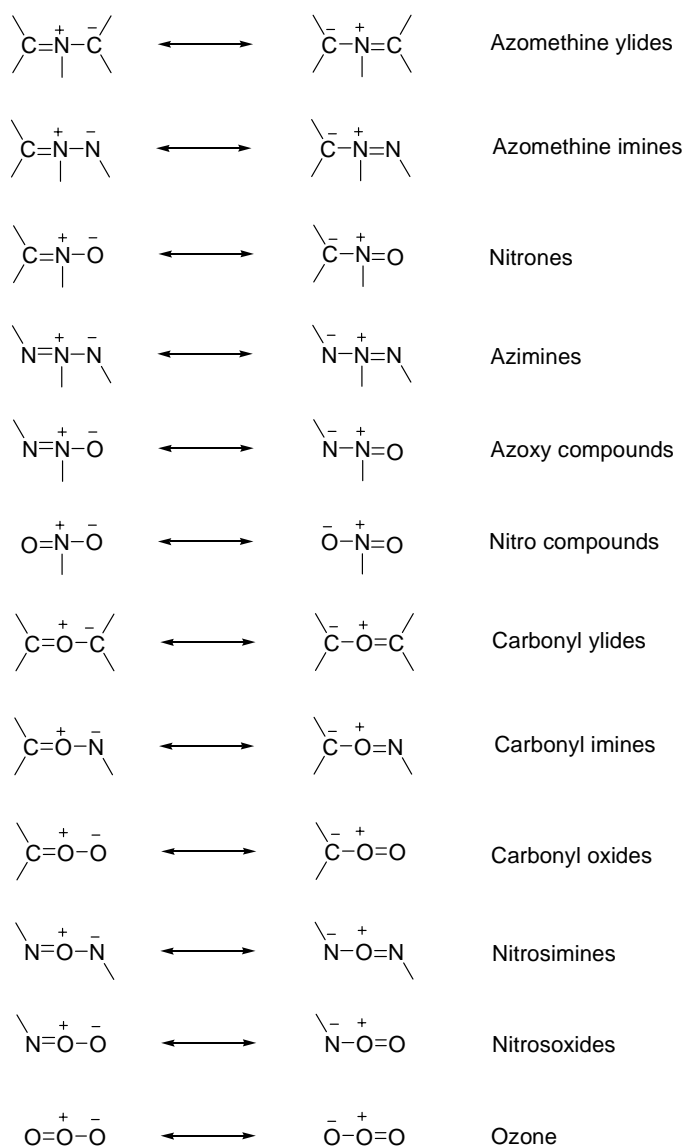
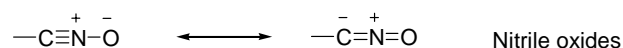
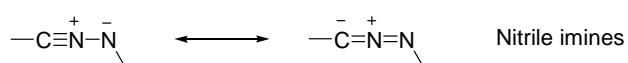
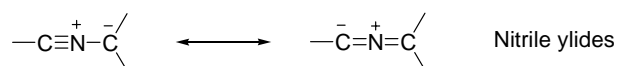
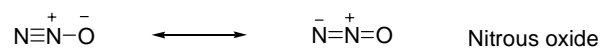
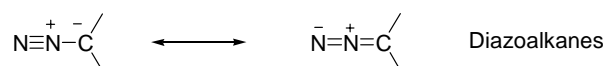
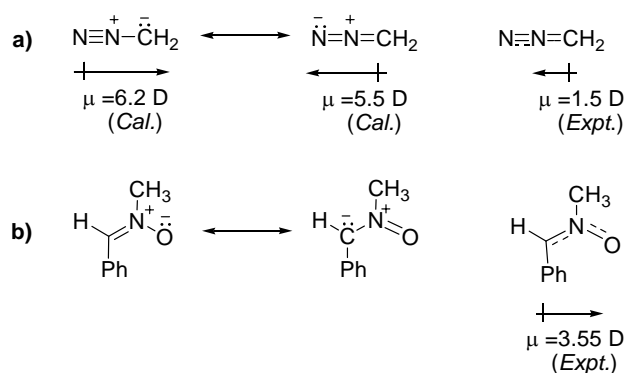

Table 1.1b.

Propargyl/Allenyl anion type 1, 3-dipoles**Nitrilium betaines****Diazonium betaines****1.3.2. Nature of 1,3-Dipole**

The term 1,3-dipole is often misinterpreted as these compounds show very high polarity. However, formal description in terms of allyl anion type π system suggests that negative charge is distributed over the two termini, *a* and *c*, while onium charge located on the central group *b*. The better balanced the distribution of negative charge, the smaller will be the polarity. For *e.g.*, the calculated dipole moment value, assuming a propargyl formula, for diazomethane is about 6.2 D, whereas in allenic form it is about 5.5 D in the opposite direction. The very low experimental value, $\mu = 1.5$ D, points towards the fact that there is considerable charge cancellation in the resonance hybrid (Scheme 1.5a). This charge compensation or charge exchange makes it

impossible to identify pure electrophilic and nucleophilic centers within the 1,3-dipolar species. Hence the 1,3-dipole is always an ambivalent compound, which either displays electrophilic and nucleophilic activity at *a* and *c* or reacts in the 1,3-position as a spin coupled diradical. The same is the case with allyl anion type 1,3-dipoles. For *e.g.*, the dipole moment of *N*-methyl-*C*-phenylnitrone, $\mu = 3.55$ D, shows a dominance of azomethine *N*-oxide structure. The terminal oxygen carries major fraction of negative charge than carbon atom (Scheme 1.5b).¹⁵



Scheme 1.5

1.3.3. Electronic Structure of 1,3-Dipoles

Even though, Huisgen represented 1,3-dipole as a zwitterionic all octet structure, a few theoretical studies indicates that certain 1,3-dipoles can be better represented as spin coupled singlet diradicals. The nature of the 1,3-dipole actually varies from a highly diradical form to an essentially pure zwitterionic form. Depending on the electronic nature, 1,3-dipoles can be classified into four groups.^{16,17}

1. Closed shell 1,3-dipoles

Diazomethane and its analogs are examples for 1,3-dipoles without diradical character and their reactions are characteristic

of closed shell species. They are relatively stable and undergo concerted 1,3-dipolar cycloadditions.

2. 1,3-Dipoles with weak diradical character

Azomethine betaines are 1,3-dipoles with very weak diradical character and the extent of diradical character is only 2-5%. For *e.g.*, Yamaguchi and Houk classified nitrones as 1,3-dipoles with very weak diradical character. This weak diradical character of azomethine betaines is removed by the introduction of polar groups. Thus in solution they can be in effect considered as zwitterions.

3. 1,3-Dipoles with moderate diradical character

Oxygenated dipoles, such as, carbonyl ylides, carbonyl imines, nitrosamines, *etc.* are examples of 1,3-dipoles with moderate diradical character.

4. 1,3-Dipoles with strong diradical character

1,3-Dipoles without octet stabilization such as trimethylene appear in this category. They are very reactive and unstable with respect to cyclization. The diradical nature of these species has been shown by calculations as 70-85%.

1.4. 1,3-Dipolarophiles

The most common dipolarophiles used in 1,3-dipolar cycloadditions are reactive molecules with a double bond or a triple bond - alkenes and alkynes. α,β -Unsaturated aldehydes, ketones, and esters, allylic alcohols, allylic halides, vinylic ethers *etc.* are examples of dipolarophiles that can readily react with 1,3-dipoles (Figure 1.5). In addition to these compounds, molecules with a double bond such as carbonyls, thiocarbonyls, imines *etc.* can also undergo cycloaddition with 1,3-dipoles.

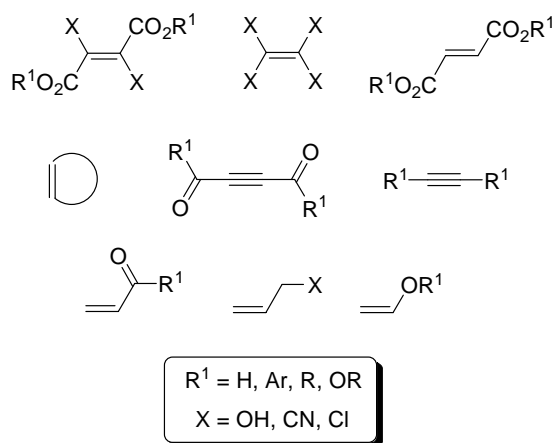
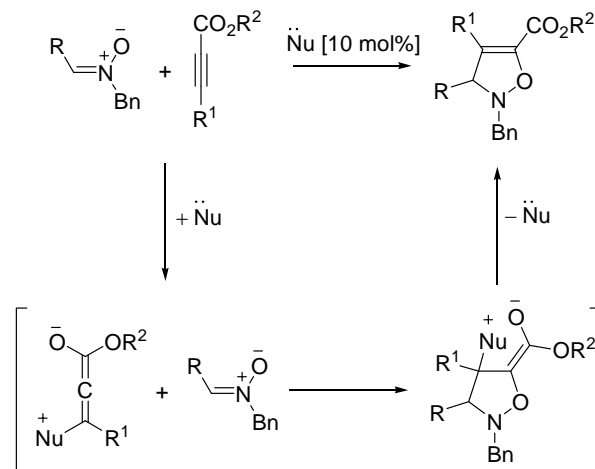

Figure 1.5

1.5. Synthetic Applications of 1,3-Dipolar Cycloadditions

Nowadays, 1,3-dipolar cycloaddition is extensively employed for the construction of heterocycles containing simple to complex ring systems.¹⁸ The simplicity of reaction, swift accretion of polyfunctionality in a fairly small molecular skeleton, high stereochemical control, and superior predictability of its regiochemistry have contributed to the popularity of 1,3-dipolar cycloaddition reaction in organic syntheses.¹⁹⁻²⁵ The pretty complex heterocycles thus obtained can be readily transformed into a variety of other cyclic as well as acyclic functionalized organic molecules.¹⁸ 1,3-Dipolar cycloaddition reaction is for that reason generally described as the single most important method for the construction of five membered heterocyclic rings in the field of synthetic organic chemistry.¹⁸ A few emerging areas in 1,3-dipolar cycloaddition reaction include transition metal catalyzed 1,3-dipolar cycloaddition reaction²⁷⁻²⁹ and tertiary phosphine/amine catalyzed 1,3-dipolar cycloaddition. For *e.g.*, Garcia *et al.* found that triphenylphosphine can catalyze the reaction between scarcely reactive phenyl *N*-benzylnitron and alkynoates. In these reactions, the first step is addition of nucleophilic tertiary

phosphine to the triple bond of electron deficient alkyne to form the allenolate - a highly reactive species - which then reacts with nitrones followed by elimination of nucleophile to give cycloadduct (Scheme 1.6).³⁰



Scheme 1.6

Some of the major reported synthetic applications of 1,3-dipolar cycloaddition chemistry include: solid phase syntheses using 1,3-dipolar cycloaddition for the synthesis of heterocycles with high degree of regioselectivity³¹ and enantioselectivity,^{32,33} polymer modification *i.e.*, transformation of polymers into reactive polymers *via* 1,3-dipolar cycloaddition,³⁴⁻³⁶ generation of nano-structured semiconductors,³⁷ surface modification of ordered mesoporous carbons,³⁸ synthesis of fluorescent single-walled carbon nano-tubes, which is used for the diagnosis and controlled drug delivery in medical field,³⁹ synthesis of modified DNA and RNA as molecular diagnostic tools,⁴⁰⁻⁴² *etc.* Detailed discussion of all these emerging applications of 1,3-dipolar addition reactions is beyond the scope of this treatise.

1.6. Mechanistic Aspects

The mechanism of 1,3-dipolar cycloaddition has been intensively investigated. The first mechanistic study was reported by Huisgen in 1963.⁴³ A few years later Woodward and Hoffman defined the concepts of pericyclic reactions and orbital symmetry and developed the interacting π electron model.⁴⁴ Fukui discovered that chemical reactivity can be explained in terms of interacting frontier molecular orbitals: the highest occupied molecular orbital (HOMO) and the lowest unoccupied molecular orbital (LUMO).⁴⁵ The transition state of cycloaddition reaction has been thoroughly studied and reviewed.⁴⁶ Whether the reaction is concerted or stepwise is a fundamental question in 1,3-dipolar cycloaddition chemistry.⁴⁷⁻⁴⁹ The arguments on the type of mechanism involved remain unresolved to date. A *via media* conclusion is that, the reactions are *concerted but not synchronous!*⁵⁰ This means the degree to which each of the two new bonds formed in the transition state is not the same *i.e.*, making of one σ bond may lag behind that of second σ bond in the transition state. The aromatic transition state of 1,3-dipolar cycloaddition has been generally considered as evidence for the concerted reaction mechanism.⁵¹

According to quantum chemical calculations, concerted 1,3-dipolar cycloaddition reaction proceed via “*early transition state*” (Figure 1.6).⁵² Thus the TS occurs early along the reaction coordinate of energy profile diagram. This has the effect of making the transition state “*reactant like*”, while a late transition state is referred to as “*product like*”. The Hammond postulate states that transition state geometry resembles that of species which is energetically closer to it.⁵³

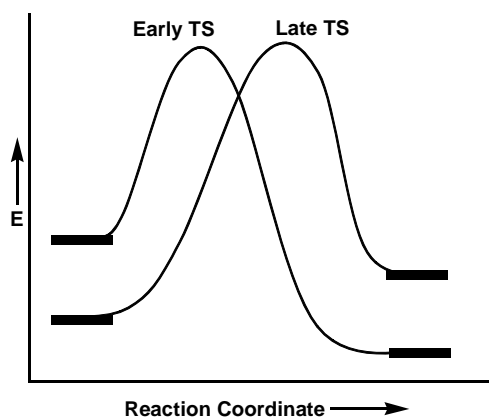
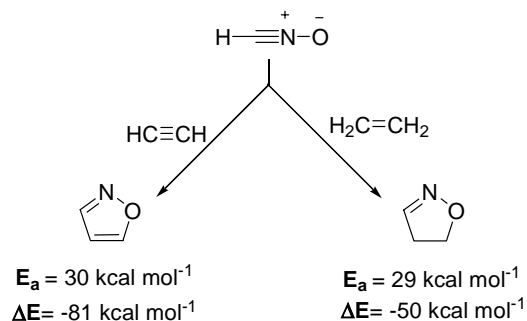

Figure 1.6

The Poppinger's calculation for the TS of fulminic acid addition to ethylene and acetylene provides some evidence for early transition state.⁵⁴ The heat of formation is much lower for isoxazole than for 2-isoxazoline as determined by *ab-initio* calculations (Scheme 1.7). This is rationalized as the aromatic system isoxazole is more stable than non-aromatic 2-isoxazoline. Nearly identical values for the calculated activation energies for the reactions with acetylene and ethylene suggest that TS of isoxazole formation does not profit from aromaticity of the product. The TS is so early that π overlap across the long σ bonds of the planar TS is very small and can be outweighed by other effects.⁵⁵



Scheme 1.7

1,3-Dipolar Cycloaddition

Molecular orbital theory has achieved a solid position in cycloaddition chemistry. Fukui,⁵⁶ Houk,⁵⁷ and many other investigators have used this theory to explain numerous mechanistic features of pericyclic reactions. According to MO theory when two molecules approach each other, the mutual “perturbation” (*i.e.*, the interaction forces) consists of three terms:^{58,59}

1. The closed shell repulsion stems from the interaction of filled orbitals of the reactants.
2. Coulombic forces can be repulsive or attractive depending on the polarities of the reactant pair.
3. The “second order perturbation term” consists of attractive interactions between all the occupied and unoccupied MOs of the reactants as long as these orbitals are of correct symmetry.

The repulsive interactions exceed the attractive ones, thus causing activation energies. PMO theory is most often used to compare reaction sequences and since the contribution of terms 1 and 2 are assumed to be constant within a series, only second order perturbation term is responsible for the variation of reactivity.⁶⁰

In 1971, Sustmann explained reactivity sequences with the help of frontier molecular orbital (FMO) theory.⁶¹ According to FMO theory the course of reaction is directed by most favorable interaction between the highest occupied molecular orbital (HOMO) and the lowest unoccupied molecular orbital (LUMO) of two reactants. Experimentally the energy of these orbitals can be quantified by measuring ionization potentials (for HOMO) and electron affinities (for LUMO). Overlapping and mixing of two orbitals having smallest energy separation result in the formation of a bonding orbital. The rate of reaction is inversely related to the energy gap. The

activated complex of 1,3-dipolar cycloaddition is assumed to consist of an arrangement of 1,3-dipole and dipolarophile in two parallel planes. The complex has a symmetry plane σ according to which HOMOs and LUMOs can be classified as symmetric or antisymmetric. Both HOMO-LUMO pairs possess the correct symmetry for interaction (Figure 1.7).⁶²

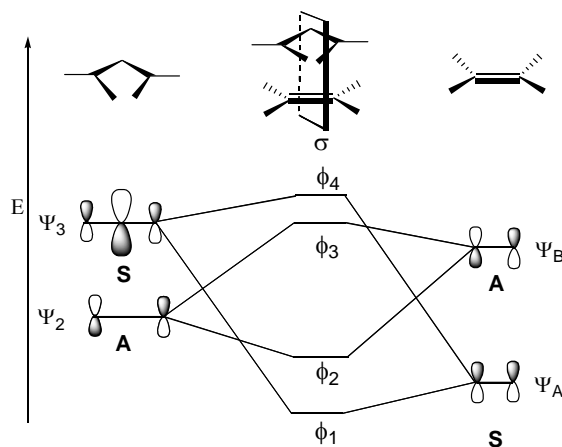

Figure 1.7 Perturbational interaction diagram for 1,3-DC

The course of concerted 1,3-dipolar cycloaddition reaction is controlled by frontier molecular orbitals (FMO) of the substrates. $\text{LUMO}_{\text{dipole}}$ can interact with $\text{HOMO}_{\text{dipolarophile}}$ and $\text{HOMO}_{\text{dipole}}$ may interact with $\text{LUMO}_{\text{dipolarophile}}$. On the basis of predominant FMO interactions, Sustman has classified 1,3-dipolar cycloaddition reactions into three types: type-I, type-II, and type-III.⁶³

In type-I 1,3-dipolar cycloaddition reaction, the dominant FMO interaction is that of $\text{HOMO}_{\text{dipole}}$ with $\text{LUMO}_{\text{dipolarophile}}$. Generally this type of 1,3-dipolar cycloaddition reaction is referred to as “normal electron demand” or “HOMO controlled” reactions. Figure 1.8 shows symmetry allowed MO interactions. In Figure 1.8, the solid arrow represents low energy interactions and dotted arrow represents high energy symmetry allowed interactions.

Cycloadditions of 1,3-dipoles of type-I are accelerated by the presence of *edg* in 1,3-dipole. The *raison d'être* here is that as electrons are donated into the HOMO of the dipole, it becomes less stable and rises in energy towards the LUMO of dipolarophile. On the other hand, *ewg* in the dipolarophile will lower the energy of the LUMO towards the HOMO of the dipole. In both cases HOMO-LUMO separation of the predominant interaction is diminished.

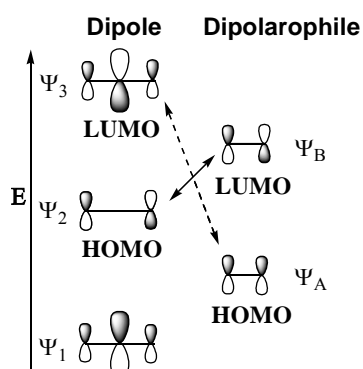

Figure 1.8 Symmetry allowed interactions of type-I 1,3-DC

In type-II, since FMO energies of the dipole and alkene are similar, both HOMO-LUMO interactions are to be considered. Adding either an *edg* or *ewg* to the dipole or dipolarophile can accelerate these reactions. Figure 1.9 shows symmetry allowed MO interactions. The azide system which is obtained by substitution of carbon atom of diazoalkanes by nitrogen belongs to this category. Electronegativity difference between carbon and nitrogen is sufficient to convert a 1,3-dipole of type-I to type-II.⁶⁴ Phenyl azide shows very high reactivity towards enamines, low reactivity towards normal alkenes such as cyclohexene and rate increases when α,β -unsaturated esters (eg. DMAD) are partners in this cycloaddition. Thus, the reactivity shows a minimum for simple alkenes, while electron-releasing as well as electron-attracting substituents increase rate of cycloaddition.

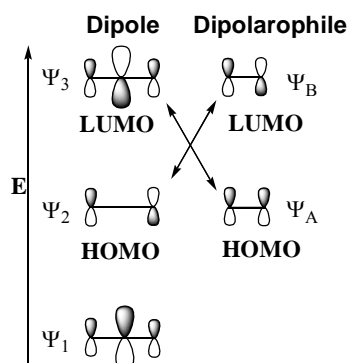

Figure 1.9 Symmetry allowed interactions of type-II 1,3-DC

Type-III 1,3-dipoles react in a manner opposite to that of type-I 1,3-dipoles. 1,3-Dipolar cycloaddition reaction of type-III is dominated by interaction between $\text{LUMO}_{\text{dipole}}$ and $\text{HOMO}_{\text{dipolarophile}}$. The term ‘*inverse electron demand*’ is used to refer to this type of 1,3-dipolar cycloaddition. This is also known as “*LUMO controlled*” reactions. Since the dominant interaction is between $\text{LUMO}_{\text{dipole}}$ and $\text{HOMO}_{\text{dipolarophile}}$, *edgs* on dipolarophile and *ewgs* on dipole will accelerate the reaction. Type-III dipoles are referred to as electrophilic because they tend to react more efficiently with electron rich dipolarophiles. Figure 1.10 shows symmetry allowed MO interactions for the reaction between type-III dipole and dipolarophile.

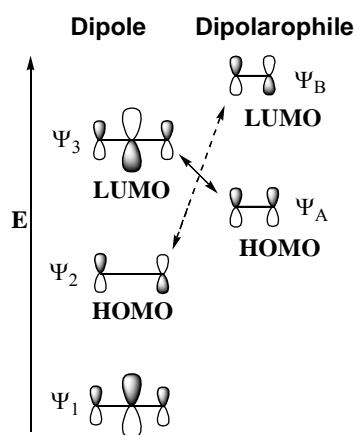

Figure 1.10 Symmetry allowed interactions of type-III 1,3-DC

1,3-Dipolar Cycloaddition

1,3-Dipolar cycloaddition of azomethine ylides and azomethine imines are typical examples for type-I. The reactions of nitrones are normally classified as type-II. 1,3-Dipolar cycloadditions of nitrile oxides are also classified as type-II, but they are better classified as borderline to type-III, since nitrile oxides have relatively low lying HOMO energies. Examples of type-III interactions are 1,3-dipolar cycloaddition of ozone and nitrous oxide. However, introduction of electron-donating or electron-withdrawing substituents on the dipole or alkene can alter the relative FMO energies, and therefore the reaction type dramatically. 1,3-Dipolar cycloaddition reaction of *N*-methyl-*C*-phenylnitronone with methyl acrylate is controlled by the $\text{HOMO}_{\text{dipole}}\text{-LUMO}_{\text{dipolarophile}}$ interaction, whereas the reaction of same nitronone with methyl vinyl ether is controlled by the $\text{LUMO}_{\text{dipole}}\text{-HOMO}_{\text{dipolarophile}}$ interaction.

Factors which stabilize/destabilize the MOs of reactants affect the reactivity. Thus, electron withdrawing substituents stabilize the MOs, electron donating substituents raise the MO energy and aromatic substituents raise the HOMO and lower the LUMO. A reduction of the MO energy of an electron-poor dipolarophile leads to a decrease of MO energy.⁶⁵

The presence of a Lewis acid in 1,3-dipolar cycloaddition can alter the orbital coefficients of reacting atoms as well as the energy of the frontier orbitals of both 1,3-dipole and dipolarophile depending on the electronic properties of these reagents or the Lewis acid.⁶⁶ Catalytic effect of Lewis acids on 1,3-dipolar cycloaddition reaction can be accounted for by the FMOs of either the 1,3-dipole, or the dipolarophile, when coordinated to the metal. This principle of activation can be applied to the 1,3-dipolar cycloaddition of nitrones in two different ways.

In the case of normal electron demand reaction, for example reaction between nitron and an electron deficient alkene such as α,β -unsaturated carbonyl compound, dominant FMO interaction is that of $\text{HOMO}_{\text{dipole}}\text{-LUMO}_{\text{alkene}}$. Coordination of a Lewis acid to the alkene will lower the energy of FMOs of alkene, relative to uncoordinated alkene. Lowering in energy of $\text{LUMO}_{\text{alkene}}$ will lead to a decrease in the energy difference between E_{HOMO} of dipole and E_{LUMO} of alkene coordinated to the Lewis acid, compared to the interaction in the absence of Lewis acid. Decreased energy gap between the interacting FMOs leads to faster reaction rates (Figure 1.11).⁶⁷

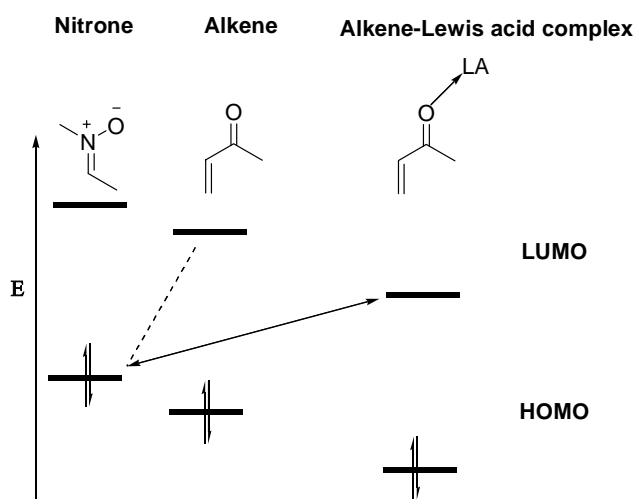

Figure 1.11

In the case of inverse electron demand reaction, for *e.g.*, reaction between nitron and an electron rich alkene like vinyl ether, FMO interaction that governs the course of reaction is $\text{HOMO}_{\text{alkene}}\text{-LUMO}_{\text{dipole}}$ interaction. Here the frontier molecular orbitals of alkene have higher energies than frontier molecular orbitals of nitron. Coordination of a Lewis acid to the nitron will lower the energy of FMOs of nitron relative to uncoordinated nitron. Lowering in energy of $\text{LUMO}_{\text{dipole}}$ will lead to a decrease in the

1,3-Dipolar Cycloaddition

energy difference between E_{HOMO} of alkene and E_{LUMO} of dipole coordinated to the Lewis acid, compared to the interaction in the absence of Lewis acid. The decreased energy gap between FMOs is responsible for the dominating interaction which leads to an enhanced rate of 1,3-dipolar cycloaddition (Figure 1.12).

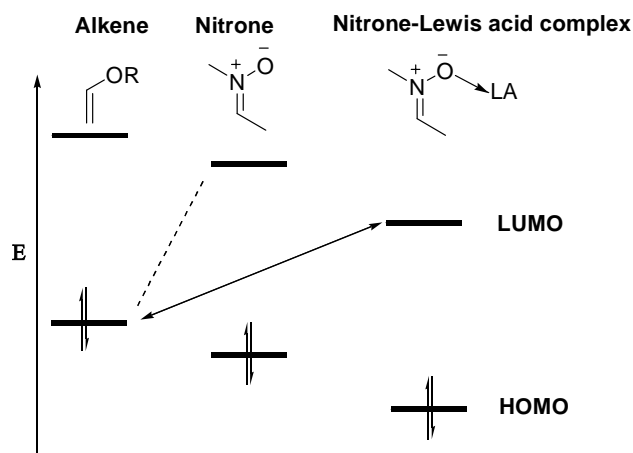

Figure 1.12

Hence the increase in reactivity of 1,3-dipole and alkene in presence of metal catalysts is due to a change in the FMO energy of substrate interacting with the catalyst. However, several examples of Lewis acid inhibition of dipolar cycloaddition reaction are also known. For *e.g.*, both percentage yield and reaction rate of addition of acrylates to aromatic nitrones or aliphatic nitrile oxides decrease in the presence of several Lewis acids.⁶⁸ These particular dipolar cycloaddition reactions are $\text{LUMO}_{\text{dipolarophile}} - \text{HOMO}_{\text{dipole}}$ controlled and complexation of Lewis acids should promote cycloaddition. However, dipoles are better Lewis bases than the dipolarophiles and consequently the catalyst interacts with dipoles which increase the MO-energy gap. Similarly, hydrogen bonding can also increase rate of 1,3-dipolar cycloaddition by reducing the MO-energies.⁶⁹ Other methods that

enhance the rate of 1,3-dipolar cycloaddition include the use of ultrasound radiation,⁷⁰ microwave radiation⁷¹⁻⁷³ as well as biocatalysis.⁷⁴

1.6.1. Solvent Effects

Huisgen studied solvent effects on the rate of 1,3-dipolar cycloaddition reaction using different combinations of dipoles and dipolarophiles. He found that, over a wide range of polarities, rate of 1,3-dipolar cycloadditions showed a remarkably small solvent dependence. For *e.g.*, in the case of cycloaddition between *N*-methyl-*C*-phenylnitrone and ethyl acrylate at 85 °C, he found that the effect of solvent polarity is very small and reaction has an inverted solvent effect *i.e.* the reaction is (slightly) retarded by polar solvents. Formation of isoxazolidine results in a decrease in polarity. The k_2 value is diminished by 5.6 fold on changing from the least polar solvent, toluene, to highly polar ethanol.⁷⁵ He therefore argued that, the activated complex of dipolar cycloaddition reaction has a smaller dipole moment than the reactants. Similar observations were found for dipolar cycloaddition between diphenyldiazomethane and dimethyl fumarate,⁷⁶ phenyl azide and enamines,⁷⁷ azomethine imines and DMAD,⁷⁸ *N*-methyl-*C*-phenylnitrone and thioketones.⁷⁹ The small solvent effect has been generally explained as a logical consequence of early transition state *i.e.*, a reactant-like structure for the transition state (Scheme 1.8).⁸⁰ Huisgen summarized these results as, the very small solvent dependence are in accordance with a concerted cycloaddition and it contradicts the formation of a zwitterionic intermediate in the rate determining step. Therefore the choice of solvents for 1,3-dipolar cycloaddition is generally based on criteria such as inertness, solubility of reactants, convenience of adduct isolation, or price and availability.⁸¹

1,3-Dipolar Cycloaddition

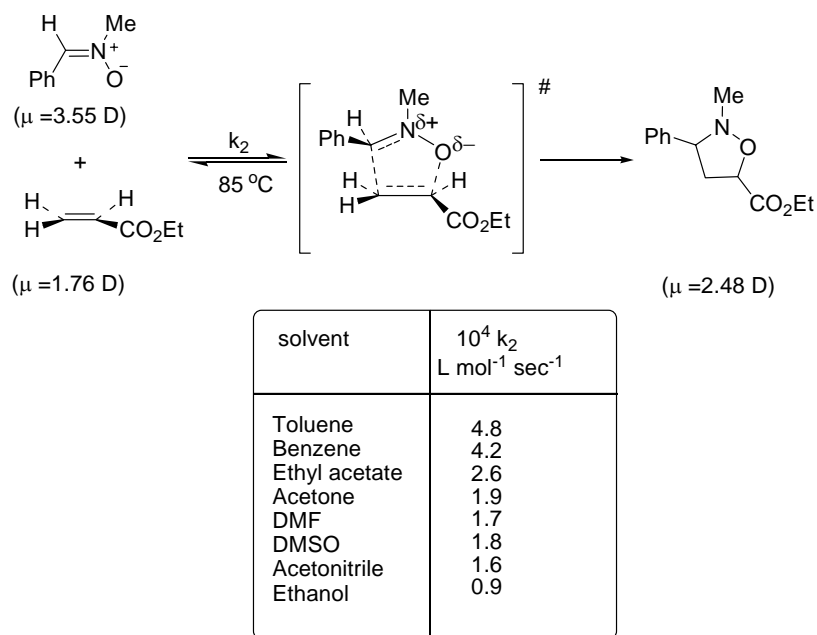

Scheme 1.8

1.6.2. Regioselectivity

1,3-Dipolar cycloaddition can be regioselective (Scheme 1.9).⁸²⁻⁸⁴ The observed regioselectivity is controlled by steric as well as electronic factors. Sometimes pure cycloadducts are isolated and occasionally a mixture of isomers is obtained.

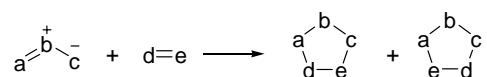

Scheme 1.9

Addition of terminal alkenes to the sterically crowded 1,3-dipoles generally leads to the formation of 5-substituted isomers (Scheme 1.10).

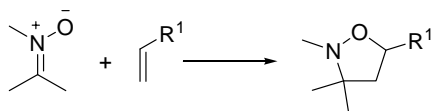
**Scheme 1.10**

Electronic effects sometimes preponderate over steric effects. For example, the cycloaddition reaction between nitronium and terminal alkenes, with *edg* in the dipolarophiles, leads to the formation of 5-substituted regio-isomer. On the other hand, terminal alkene with *ewg* leads to the formation of 4-substituted isomer. The former reaction is mostly controlled by $\text{LUMO}_{\text{dipole}} - \text{HOMO}_{\text{dipolarophile}}$ interaction. The $\text{LUMO}_{\text{dipole}}$ has largest coefficient at the carbon atom and the $\text{HOMO}_{\text{dipolarophile}}$ has largest coefficient at the terminal carbon atom. Thus, the nitronium and alkene combine in a regioselective manner to give the 5-isoxazolidine. Steric factors also support the formation of same isomer (Scheme **1.11a**). The second reaction is mainly controlled by the $\text{HOMO}_{\text{dipole}} - \text{LUMO}_{\text{dipolarophile}}$ interaction. The $\text{HOMO}_{\text{dipole}}$ has largest coefficient at the oxygen atom, whereas $\text{LUMO}_{\text{dipolarophile}}$ has largest coefficient at the terminal carbon atom. This favours formation of the 4-isomer, but since steric factors oppose this, a mixture of regioisomers is often obtained (Scheme **1.11b**). In the case of the reaction between nitronium and 1,2-disubstituted alkene with *ewg*, steric factor is eliminated, leading to the formation of 4-*ewg*-substituted isomer as the sole product (Scheme **1.11c**).

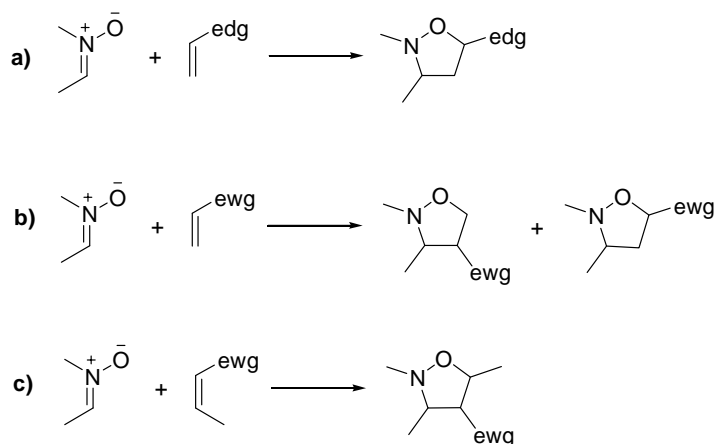

Scheme 1.11

1.6.3. Diastereoselectivity

Preferential formation of one stereoisomer over another in a chemical reaction is known as stereoselectivity. When the stereoisomers are enantiomers, the phenomenon is called enantioselectivity and is quantitatively expressed by the enantiomer excess (*ee*); when they are diastereoisomers, it is called diastereoselectivity and is quantitatively expressed by the diastereoisomer excess (*de*).⁸⁵ When 1,2-disubstituted alkenes are involved in 1,3-dipolar cycloaddition reaction with 1,3-dipoles, two new chiral centers can be formed in a stereospecific manner due to the *syn* attack of the dipole on the double bond. If the alkene and 1,3-dipole, containing a chiral center approach in an *endo* or *exo* fashion, they give rise to a pair of diastereomers. The *endo* isomer arises from the reaction in which nitrogen atom of the dipole points in the same direction as the substituent of alkene, whereas, the *exo* isomer arises from the reaction in which the nitrogen atom of the dipole points in opposite direction as the substituent of alkene (Scheme 1.12). Since the secondary orbital interactions are very weak as compared to Diels-Alder reaction, the *endo/exo* selectivity in 1,3-dipolar cycloaddition reaction is

mainly controlled by the structure of substrates and the presence of catalysts.^{86,87}

Endo-TS for Diels- Alder reaction

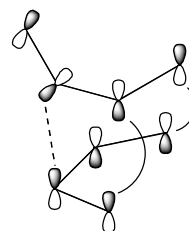
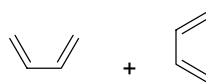

TS for 1,3-DC

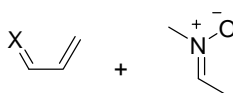

endo

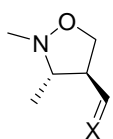
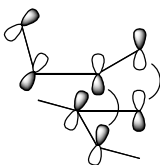

endo
or 3,4-*trans*

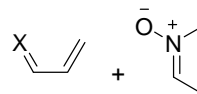

exo

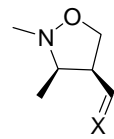
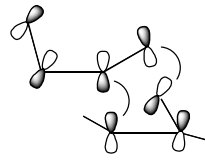

exo
or 3,4-*cis*

Scheme 1.12

1.6.4. Stereospecificity - A Mechanistic Probe

Stereospecificity is an important criterion for the concertedness of cycloaddition. As long as the 1,3-dipole and dipolarophile are

1,3-Dipolar Cycloaddition

configurationally stable compounds, no rotation about the crucial bonds is conceivable during the concerted formation of new σ -bonds. That is, stereospecificity of the cycloaddition has been cited as evidence supporting the concerted reaction: *cis*-1,2-disubstituted dipolarophiles give *cis*-substituted pentacycles, and *trans*-1,2-disubstituted dipolarophiles give *trans*-substituted pentacycles (Scheme 1.13).⁸⁸ This stereospecific nature of 1,3-dipolar cycloaddition rules out the diradical mechanism proposed by Firestone.⁸⁹⁻⁹² In 1985, while working with K. N. Houk on 1,3-dipolar cycloaddition reaction of benzonitrile oxide with styrene and methyl acrylate, the stereospecificity observed forced Firestone to accept the concerted mechanism proposed by Huisgen.^{93,94}

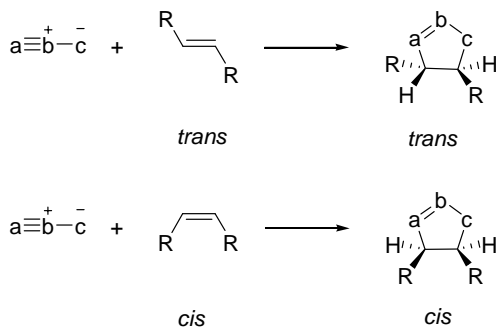

Scheme 1.13

1.6.5. Concerted to Two-Step Pathway

In 1986, Huisgen reported the first two-step 1,3-dipolar cycloaddition.^{95,96} He found that, when a highly electron-rich thiocarbonyl ylide dipole adds to an electron-deficient dipolarophile, such as a dicyano-substituted alkene, there is a scrambling of stereochemistry in the products. The *E*-alkene dipolarophile gave rise to both *cis*- and *trans*- products (Scheme 1.14).

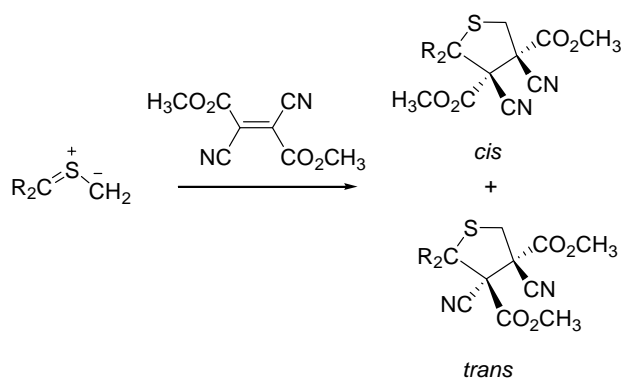

Scheme 1.14

Huisgen proposed a two-step zwitterionic mechanism for this reaction, where the rate of rotation about the zwitterionic σ -bond was competitive with the formation of the second, ring-closing bond (Scheme 1.15)

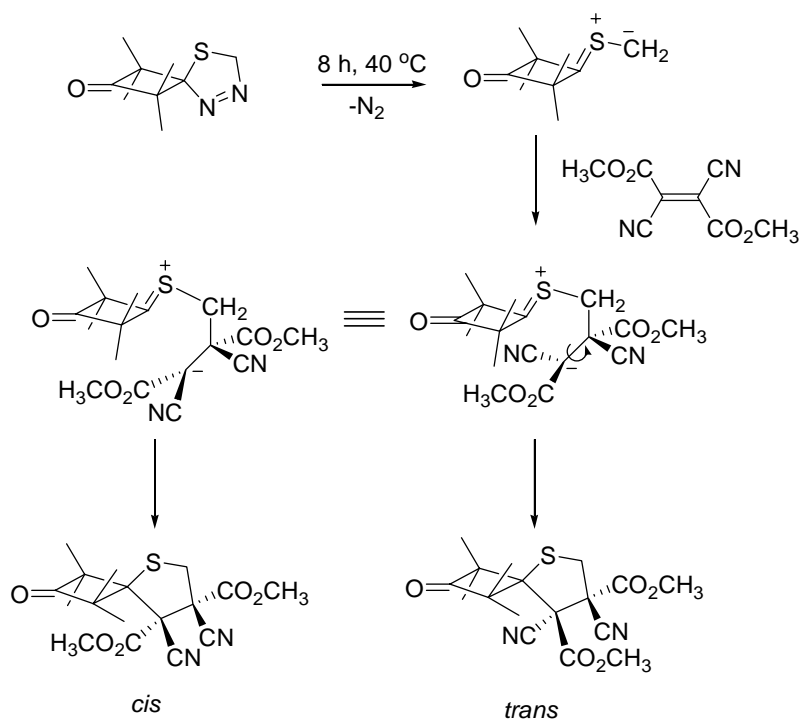

Scheme 1.15

1,3-Dipolar Cycloaddition

The basis for such a proposal was the following experimental facts:-

1. The reaction was not stereospecific.
2. He found that the *cis:trans* ratio increased with an increase in solvent polarity, consistent with charge separation greater than that in the initial ylide: CCl₄ 37:1, toluene 36:1, CS₂ 40:1, THF 48:1, CH₂Cl₂ 47:1, acetone 60:1, CH₃CN 62:1.
3. Finally the formation of the ring enlarged product along with the normal adduct in the case of the reaction between thiocarbonyl ylide and tetracyanoethylene could be explained only with the help of a zwitterionic intermediate (Scheme 1.16)

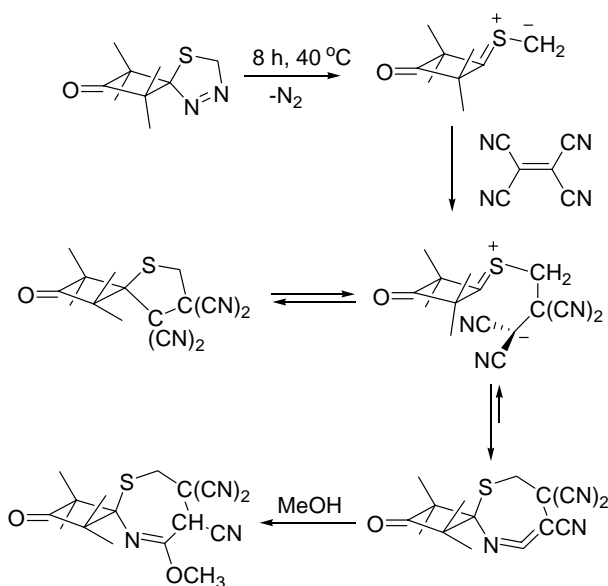

Scheme 1.16

In accordance with the theoretical prediction,⁹⁷ Huisgen concluded that, by making the dipole electron deficient and the dipolarophile electron rich (or *vice versa*) and thereby making a large difference in HOMO - LUMO

energies of reaction partners as well as a pronounced steric hindrance at one termini of the 1,3-dipole, bond formation in concerted reaction will become asynchronous. When this is taken to the extreme, bond formation becomes so asynchronous that a zwitterionic intermediate is formed which results in nonstereospecific 1,3-dipolar cycloadditions.^{95,96} Recently advanced theoretical studies carried out on different systems also lead to the conclusion that dipoles follow both concerted as well as stepwise paths and occasionally they may be in close competition.⁹⁸⁻¹⁰⁰

1.7. Definition of the Problem

It is evident from the literature analysis that, there are different views on the mechanism of 1,3-dipolar cycloaddition reaction. The lack of solid experimental proof is the real cause for this disagreement. Together with this issue, our continued interest in the area of synthesis and transformations of heterocycles as well as reactions using novel reagents¹⁰¹⁻¹⁰³ prompted us to explore the synthetic potential as well as mechanism of 1,3-dipolar cycloaddition reaction. For our present study we selected azomethine oxides (nitrones) and azomethine imines as dipoles.

Nitrones as well as azomethine imines belong to the class of allyl anion type 1,3-dipoles. They have four π -electrons in three parallel p -orbitals perpendicular to the plane of 1,3-dipole and possess a bent structure. In order to study the effect of steric factors on the course of 1,3-dipolar cycloaddition, we chose a few nitrones which differ in steric crowding on the α -C of nitrone. The dipole moment measurement as well as the existence of geometrical isomerism in unsymmetrical nitrones reveals that terminal oxygen carries the major portion of negative charge, which makes nitrones nucleophilic in nature.^{15,104} To examine the effect of nucleophilicity of 1,3-dipole, we selected a few azomethine imines where the nucleophilicity

is reduced by introducing an electron withdrawing group on the β -N of the azomethine imine.

Dibenzoylacetylene is chosen as the dipolarophile. One of the reasons for the selection of DBA as dipolarophile is that, introduction of electron withdrawing substituents into an acetylenic dipolarophile will increase rate constants by several orders.¹⁰⁵ Another reason is that, the negative charge of zwitterions, if formed as a result of a stepwise addition, will be stabilized by the anion stabilizing benzoyl groups. Dibenzoylalkene systems are known to undergo cyclisation to pharmacologically significant oxygen heterocycles. Preliminary biological studies conducted on a few 3(2*H*)-furanones prepared by us utilizing dibenzoylalkene chemistry revealed that they can effectively inhibit the tumor cell proliferation.^{105,107} Though a bit farfetched, we anticipated generation of 3(2*H*)-furanones in a possible nonconcerted reaction between nitrones and dibenzoylacetylene.

1.8. Objectives

1. Synthesis of 1,3-dipoles
 - Nitrones
 - Azomethine imines
2. Study the reactions of nitrones with DBA
 - Chemical transformations of nitrone-DBA adducts
3. Study the reactions of azomethine imines with DBA
 - Chemical transformations of azomethine imine-DBA adducts

4. Comparison of the reactivity profile of nitrones with that of azomethine imines
5. Novel insight into the mechanism of the reaction between 1,3-dipoles and electron deficient acetylenes

1.9. References and Notes

1. Moss, G. P., Smith, P. A. S.; Tavernier, D. *Pure Appl. Chem.* **1995**, *67*, 1307.
2. Benedlt, D.; Daniel, V. *J. Med. Chem.* **1994**, *37*, 710.
3. Pereira, E. R.; Sancelme, M; Voldoire, A.; Prudhomme, M. *Bioorg, Med. Chem. Lett.* **1997**, *7*, 2503.
4. Komeilizadeh, H. *Iran. J. Pharm. Res.* **2006**, *4*, 229.
5. R. Huisgen, *Angew. Chem., int. Ed. Eng.* **1963**, *2*, 565.
6. Curtius, T. *Ber. Dtsch. Chem. Ges.* **1883**, *16*, 2230.
7. Büchner, E. *Ber. Dtsch. Chem. Ges.* **1888**, *21*, 2637.
8. Pechmann, H. V. *Ber. Dtsch. Chem. Ges.* **1894**, *27*, 1888.
9. Ueber, M. A. *J. Prakt. Chem.* **1893**, *48*, 94.
10. Beckmann, E. *Ber. Dtsch. Chem. Ges.* **1890**, *23*, 3331.
11. Werner, A.; Buss, H. *Ber. Dtsch. Chem. Ges.* **1894**, *27*, 2193.
12. Smith, L. I. *Chem. Rev.* **1938**, *23*, 193.
13. Huisgen, R. *Angew. Chem., Int. Ed.* **1968**, *7*, 321.
14. Huisgen, R. 1,3-Dipolar Cycloadditions- Introduction, Survey, Mechanism. In *1,3-Dipolar Cycloaddition Chemistry*, Padwa, A. Ed.; Wiley Interscience: New York, **1984**, Vol.1, pp 3.

15. Huisgen, R. *Chem. Ber.* **1969**, *102*, 1102.
16. Houk, K. N.; Yamaguchi, K. Theory of 1,3-Dipolar Cycloaddition. In *1,3-Dipolar Cycloaddition Chemistry*, Padwa, A., Ed., Wiley Inter Science: New York, **1984**, Vol. 2, pp 407.
17. Cooper, D. L.; Gerraatt, J.; Raimondi, M.; Wright, S. C. *Chem. Phys. Lett.* **1987**, *138*, 296.
18. Padwa, A.; Pearson, W. H. *Synthetic Applications of 1,3-Dipolar Cycloaddition Chemistry Towards Heterocycles and Natural Products*, John Wiley and sons Inc.: New York, 2002.
19. Padwa, A. *Angew. Chem., Int. Ed. Engl.* **1976**, *15*, 123.
20. Kim, Y. Kim, J.; Park, S. B. *Org. Lett.* **2009**, *11*, 17.
21. Jen, W. S.; Wiener, J. J. M.; MacMillan, D. W. C. *J. Am. Chem. Soc.* **2000**, *122*, 9874.
22. Alemparte, C. ; Blay, G.; Jørgensen, K. A. *Org. Lett.* **2005**, *7*, 4569.
23. Carmona, D.; Lamata, M. P.; Viguri, F.; Rodriguez, R.; Oro, L. A.; Lahoz, F. J.; Balana, A. I.; Tejero, T. ; Merino, P. *J. Am. Chem. Soc.* **2005**, *127*, 13386.
24. Najeera, C.; Sansano, J.M. *Angew. Chem. Int. Ed.* **2005**, *44*, 6272.
25. Yan, X.; Hou, X.; Wu, Y. *Angew. Chem. Int. Ed.* **2006**, *45*, 1979.
26. Gothelf, K. V.; Jørgensen, K. A. *Chem. Rev.* **1998**, *98*, 863.
27. Oura, I.; Shimizu, K.; Ogata, K. Fukuzawa, S. *Org. Lett.* **2010**, *12*, 1752.

28. Hashimoto, T.; Maeda, Y.; Omote, M.; Nakatsu, H. , Maruoka, K. *J. Am. Chem. Soc.* **2010**, *132*, 4076.
29. Yu, J.; He, L. Chen, X.; Song, J.; Chen, W.; Gong, L. *Org. Lett.* **2009**, *11*, 4946.
30. Gonzalez, D.; Tejedor, D.; Armas, P.; Morales, E. Q.; Garcia, F. *Chem. Commun.* **2006**, 2798.
31. Ramamoorthy, V.; Meenakshi, C.; Muthusubramanian, S.; Sivasubramanian, S. *J. Incl. Phenom. Macrocyclic Chem.* **2000**, *36*, 425.
32. Harju, K.; Vahermo, M.; Mutikainen, I.; Kauhaluoma, J. Y. *J. Comb. Chem.* **2003**, *5*, 826.
33. Harju, K.; Yli-Kauhaluoma, J. *Recent Res. Devel. Organic Chem.* **2004**, *8*, 111.
34. Lee, Y.; Koyama, Y.; Yonekawa, M.; Takata, T. *Macromolecules* **2009**, *42*, 7709.
35. Singh, I.; Zarafshani, Z.; Lutz, J.F.; Heaney, F. *Macromolecules* **2009**, *42*, 5411.
36. Vretik, L.; Ritter, H. *Macromolecules* **2003**, *36*, 6340.
37. Bakbak, S.; Leech, P. J.; Carson, B. E.; Saxena, S.; King, W. P.; Bunz, U.H. F. *Macromolecules* **2006**, *39*, 6793.
38. Wang, X.; Jiang, D.; Dai, S. *Chem. Mater.* **2008**, *20*, 4800.
39. Bayazit, M. K.; Coleman, K. S. *J. Am. Chem. Soc.* **2009**, *131*, 10670.

-
40. Gutmiedl, K.; Wirges, C. T.; Ehmke, V.; Carell, T. *Org. Lett.* **2009**, *11*, 2405.
 41. Amblard, F.; Cho, J. H.; Schinazi, R. F. *Chem. Rev.* **2009**, *109*, 4207.
 42. Ju, J.; Seo, T. S.; Li, Z. *Tetrahedron Lett.* **2004**, *45*, 3143.
 43. Huisgen, R. *Angew. Chem. Int. Ed.* **1963**, *2*, 633.
 44. Woodward, R. B.; Hoffmann, R. *Angew. Chem. Int. Ed.* **1969**, *8*, 781.
 45. Fukui, K. *Acc. Chem. Res.* **1971**, *4*, 57.
 46. Houk, K. N.; Gonzalez, J.; Li, Y. *Acc. Chem. Res.* **1995**, *28*, 81.
 47. Firestone, R. A. *J. Org. Chem.* **1968**, *33*, 2285.
 48. Huisgen, R. *J. Org. Chem.* **1968**, *33*, 2291.
 49. Huisgen, R. *J. Org. Chem.* **1976**, *41*, 403.
 50. Houk, K. N.; Firestone, R. A.; Munchausen, L. L.; Mueller, P. H.; Arison, B. H.; Garcia, L. A. *J. Am. Chem. Soc.* **1985**, *107*, 7227.
 51. Morao, I.; Lecea, B.; Cossio, F. P. *J. Org. Chem.* **1997**, *62*, 7033.
 52. Huisgen, R. 1,3-Dipolar Cycloadditions- Introduction, Survey, Mechanism. In *1,3-Dipolar Cycloaddition Chemistry*, Padwa, A. Ed.; Wiley Interscience: New York, **1984**, Vol.1, pp 44.
 53. Rastelli, A.; Gandofi, R.; Amade, M. S. *J. Org. Chem.* **1998**, *63*, 7425.
 54. Poppinger, D. *J. Am. Chem. Soc.* **1975**, *97*, 7486.
-

55. Poppinger, D. *Aust.J.Chem.* **1976**, 29, 465.
56. Fukui, K. *Acc. Chem. Res.* **1971**, 4, 57.
57. Houk, K. N. *J. Am. Chem. Soc.* **1973**, 95, 4092.
58. Klopman, G. *J. Am. Chem. Soc.* **1968**, 90, 223.
59. Houk, K. N.; Sims, J.; Watts, C. R.; Luskus, L. J. *J. Am. Chem. Soc.* **1973**, 95, 7301.
60. Huisgen, R. 1,3-Dipolar Cycloadditions -Introduction, Survey, Mechanism. In *1,3-Dipolar Cycloaddition Chemistry*, Padwa, A. Ed.; Wiley Interscience: New York, **1984**, Vol.1, pp 107.
61. Sustmann, R.; Trill, H. *Angew. Chem., Int. Ed. Engl.* **1972**, 11, 838.
62. Eckell, A.; Huisgen, R.; Sustmann, R.; Wallbillich, G.; Grashey D.; Spindler, E. *Chem. Ber.* **1967**, 100, 2192.
63. Sustmann, R. *Pure Appl. Chem.* **1974**, 40, 569.
64. Huisgen, R.; Szeimies, G.; Moebius, L. *Chem. Ber.* **1967**, 100, 2494.
65. Houk, K. N. *J. Am. Chem. Soc.* **1973**, 95, 4092.
66. Gothelf, K. V.; Jorgenson, K. A. *Chem. Com.* **2000**, 1449.
67. Gothelf, K. V.; Jorgenson, K. A. *Acta Chem. Scand.* **1996**, 50, 652.
68. Curran, D. P.; Kim, B. H.; Piyasena, H. P.; Loncharich, R. J.; Houk, K. N. *J. Org. Chem.* **1987**, 52, 2137.

69. Laszlo, P.; Lucche, J. *Actual. Chim.* **1984**, 42.
70. Armstrong, S. K.; Warren, S.; Collington, E. W.; Naylor, A. *Tetrahedron Lett.* **1991**, 32, 4171.
71. Pineiro, M.; Melo, T *Eur. J. Org. Chem.* **2009**, 31, 5287.
72. Andrade, M. M.; Barros, M. T. *Arkivoc* **2009**, 11, 299.
73. Baruah, B.; Prajapathi, D.; Baruah, A.; Sandhu, J. S. *Synth. Commun.* **1997**, 27, 2563.
74. Roa, K. R.; Bhanumathi, N.; Srinivasan, T. N.; Sattur, P. B. *Tetrahedron Lett.* **1990**, 31, 899.
75. Huisgen, R. *Pure Appl. Chem.* **1980**, 52, 2283.
76. Huisgen, R.; Seidl, H.; Bruning, I. *Chem. Ber.* **1969**, 102, 1102.
77. Meilahn, M. K.; Cox, B.; Munk, M. E. *J. Org. Chem.* **1975**, 40, 819.
78. Eckell, A.; George, M. V.; Huisgen, R.; Kende, A. S. *Chem. Ber.* **1977**, 110, 578.
79. Huisgen, R.; Fisera, L.; Giera, H.; Sustmann, R. *J. Am. Chem. Soc.* **1995**, 117, 9671.
80. Huisgen, R. *J. Org. Chem.* **1976**, 41, 403.
81. Huisgen, R. 1,3-Dipolar Cycloadditions- Introduction, Survey, Mechanism. In *1,3-Dipolar Cycloaddition Chemistry*, Padwa, A. Ed.; Wiley Interscience: New York, **1984**, Vol.1, pp 83.

82. Mendez, F.; Tamariz, J.; Geerlings, P. *J. Phys. Chem. A* **1998**, *102*, 6292.
83. Gothelf, K. V.; Jorgensen, K. A. *Chem. Rev.* **1998**, *98*, 863.
84. Gothelf, K. V. *Cycloaddition Reactions in Organic Synthesis*; Kobayashi, S.; Jorgensen, K. A., Ed.; Wiley-VCH Verlag GmbH **2001**, pp 216.
85. *IUPAC Compendium of Chemical Terminology* **1996**, *68*, 2219.
86. Gothelf, K. V.; Hazell, R. G.; Jorgensen, K. A. *J. Org. Chem.* **1996**, *61*, 346.
87. Gothelf, K. V. *Cycloaddition Reactions in Organic Synthesis*; Kobayashi, S.; Jorgensen, K. A., Ed.; Wiley-VCH Verlag GmbH, **2001**, pp 217.
88. Huisgen, R. *Angew. Chem.* **1962**, *75*, 604.
89. Firestone, R. A. *J. Org. Chem.* **1968**, *33*, 2285.
90. Firestone, R. A. *J. Org. Chem.* **1972**, *37*, 2181.
91. Firestone, R. A. *J. Chem. Soc. A* **1970**, 1570.
92. Firestone, R. A. *Tetrahedron* **1977**, *33*, 3009.
93. Houk, K. N.; Firestone, R. A.; Munchausen, L. L.; Mueller, P. H.; Arison, B. H.; Garcia, L. A. *J. Am. Chem. Soc.* **1985**, *107*, 7227.
94. Houk, K. N.; Gonsalaz, J.; Li, Y. *Acc. Chem. Res.* **1995**, *28*, 81.
95. Huisgen, R.; Mloston, G.; Langhals, E. *J. Org. Chem.* **1986**, *51*, 4085.

96. Huisgen, R.; Mloston, G.; Langhals, E. *J. Am. Chem. Soc.* **1986**, *108*, 6401.
97. Sustmann, R. *Pure. Appl. Chem.* **1974**, *40*, 569.
98. Kavitha, K.; Venuvalingam, P. *Int. J. Quantum Chem.* **2005**, *104*, 64.
99. Domingo, L.R.; Picher, M. F. *Tetrahedron* **2004**, *60*, 5053.
100. Cantillo, D.; Avalos, M.; Babiano, R.; Cintas, P.; Jimenez, J. C.; Light, M. E.; Palacios, J. C. *Org. Lett.* **2008**, *10*, 1079.
101. Rappai, J. P.; Prathapan, S.; Vishnu Unni, M. V.; Unnikrishnan, P. A. *Synth. Commun.* **2007**, *37*, 569.
102. Jacob, A. M.; Thumpakkara, R. K.; Prathapan, S. Jose, B. *Tetrahedron* **2005**, *61*, 4601.
103. Vadakkan, J. J.; Raman, V.; Fernandez, N. B. Prathapan, S.; Jose, B. *New J. Chem.* **2003**, *27*, 239.
104. Hamer, J.; Macaluso, A. *Chem. Rev.* **1964**, *64*, 473.
105. Huisgen, R.; Fisera, L.; Giera, H.; Sustmann, R. *J. Am. Chem. Soc.* **1995**, *117*, 9671.
106. Rappai, J. P.; Raman, V.; Unnikrishnan, P. A.; Prathapan, S.; Thomas, S. K.; Paulose, C. S. *Bioorg. Med. Chem. Lett.* **2009**, *19*, 764.
107. Our findings on remarkable inhibition of tumor proliferation by 3(2H)-furanones reported in the above reference are not included in this thesis.

1,3-Dipolar Cycloaddition

Chapter 2

SYNTHESIS OF NITRONES

2.1. Abstract

In this chapter, we describe the synthesis and characterization of a few selected ketonitrones and aldonitrones.

2.2. Introduction

Nitrones, also known as azomethine *N*-oxides, constitute an important class of 1,3-dipoles generally used for the construction of nitrogen and oxygen heterocycles.^{1,2} They belong to the class of allyl anion type 1,3-dipoles having octet stabilization with four π electrons in three parallel *p*-orbitals perpendicular to the plane of 1,3-dipole (Scheme 2.1).³ The observed dipole moment of nitrones, for example, *N*-methyl-*C*-phenyl-nitrone, $\mu = 3.55$ D, shows a dominance of the azomethine *N*-oxide structure. That is, terminal oxygen carries the major portion of negative charge than carbon atom. Accordingly nitrones exhibit nucleophilic character in many of their reactions.⁴

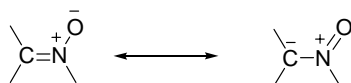

Scheme 2.1

Nitrones were first prepared by Beckmann in 1890^{5,6} and the name nitrone was derived from abbreviation of “nitrogen-ketones” by Pfeiffer in 1916 to highlight their resemblance to ketones.⁷ The terms aldonitrones and ketonitrones are used to distinguish between nitrones with and without a proton on the α -C of nitrone, respectively (Figure 2.1).

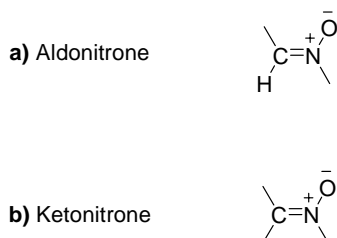

Figure 2.1

Nitrones can exhibit geometrical isomerism because of the presence of a double bond in the functional group. The existence of geometric isomerism in nitrones was first established in 1918 for α -phenyl- α -(4-methylphenyl)-*N*-methylnitrone.⁸ Nitrones (acyclic) can exist in either *E*- or *Z*-form. These geometrical isomers are readily distinguishable by dipole moment measurements. The *Z*-isomer will have a larger dipole moment value than corresponding *E*-isomer (Figure 2.2).⁹ The geometrical isomers can be readily interconverted either thermally¹⁰ or photochemically.¹¹ Incidentally, occurrence of geometrical isomerism in unsymmetrical nitrones adds further support to dipolar structure with negative charge concentrated on oxygen.

Nitrones are emerging as an important class of synthetic intermediates. They are extensively used as 1,3-dipole in cycloaddition reactions to synthesize a variety of heterocyclic compounds ranging from simple to complex.² Nitrones can react with alkenes as well as alkynes to

form isoxazolidines and isoxazolines respectively.¹²⁻¹⁷ They can also react with allenes,^{18,19} ketenes,²⁰ isocyanates,^{21,22} isothiocyanates,^{23,24} nitriles,²⁵ *etc.* to furnish a broad spectrum of heterocycles. Recently, nitrones have been shown to undergo interesting reactions with Burgess reagent.^{26,27}

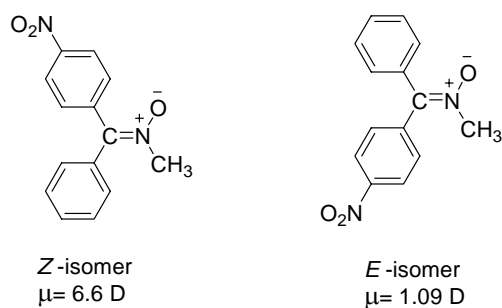
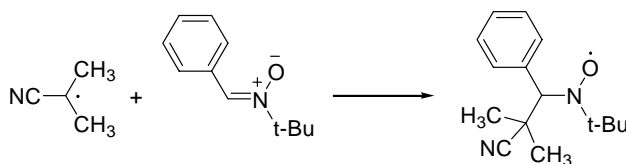

Figure 2.2

Apart from their synthetic potential as 1,3-dipole, nitrones are also used as spin traps for distinguishing free radical species, especially when direct detection of some free radicals (for *e.g.*, superoxide and hydroxyl radical) becomes very difficult.²⁸ Spin trapping is a technique developed in the late 1960s where a nitronium reacts with a target free radical to form a stable and distinguishable free radical to be detected by EPR spectroscopy. For *e.g.*, when 2-cyanopropan-2-yl free radical adds to α -phenyl-*N-tert*-butylnitronium (PBN), a relatively stable nitroxide radical will be formed (Scheme 2.2).^{29, 30}



Scheme 2.2

Spin trapping is the only known method that can detect free radicals such as superoxide and hydroxyl radical specifically in biological systems.

α -Phenyl-*N*-*tert*-butylnitron (PBN),³¹⁻³⁴ 5,5-dimethyl-1-pyrroline *N*-oxide (DMPO),^{35, 36} 5-*tert*-butoxycarbonyl-5-methyl-1-pyrroline *N*-oxide (BMPO),³⁷ etc. are the most widely used spin traps in biological systems to investigate the implication of short-lived free radicals in several clinical disorders (Figure 2.3). Nitrones can also act as antioxidants in biological systems and clinical studies revealed that they can inhibit hepatocarcinogenesis in rats.³⁸ Very recently, they have also been considered as therapeutics in age related diseases.³⁹

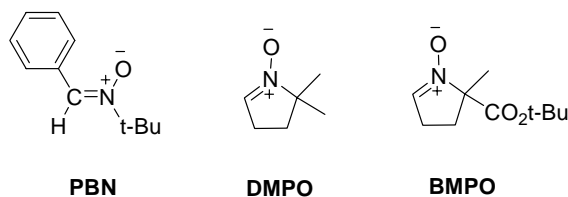

Figure 2.3

Thus, nitrones find diverse applications ranging from acting as 1,3-dipoles to nucleophiles to radical traps. Such functional diversity points to different reaction possibilities involving this versatile species. An intriguing possibility here is that nitrones can react with electron deficient acetylenes to give isoxazolines (or products derived thereof) through three different mechanistic extremes including:

1. A typical concerted 1,3-dipolar cycloaddition
2. Michael type addition followed by ring closure
3. Free radical pathway

Careful analysis of the reaction between nitrones and electron deficient acetylenes can thus provide definite answers to a few sticking points on the mechanism of 1,3-dipolar cycloaddition reactions highlighted in

Chapter 1. In this context, we undertook the present study on the synthesis of nitrones with a view to examine their reaction with electron deficient acetylenes.

2.2.1. General Methods for the Synthesis of Nitrones

Nitrones are in general synthesized *via* one of the following methods:-

- I) Condensation of diazo compounds with nitroso arenes. Success of this process is contingent upon the availability of stable diazo and nitroso compounds such as diaryldiazomethanes and aryl nitroso compounds. Consequently, this procedure is commonly employed for the generation of triarylnitrones (Scheme 2.3).⁴⁰

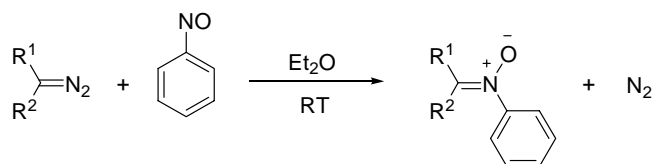

Scheme 2.3

- II) Oxidation of imines with *m*-CPBA (Scheme 2.4)⁴¹ or with potassium permanganate under phase transfer conditions is another common strategy for the synthesis of ketonitrones.⁴²

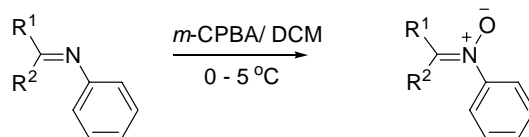

Scheme 2.4

- III) Condensation of carbonyl compounds with *N*-substituted hydroxylamines will lead to the formation of diaryl nitrones.

Since arylhydroxylamines are readily accessible, this method is generally used for the synthesis of α,N -diarylnitrones (Scheme 2.5).¹

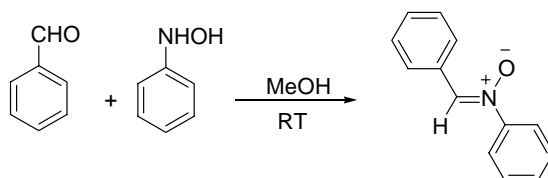

Scheme 2.5

IV) To bypass the involvement of less stable substituted phenylhydroxylamines, Chapoulaud *et al.* reported a one-pot synthesis of N -alkyl as well as N -aryl substituted aldonitrones which involves the condensation of aldehydes with *in situ* generated hydroxylamines, readily obtained from commercially available nitro compounds (Scheme 2.6).⁴³

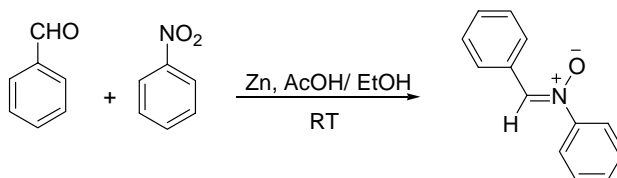

Scheme 2.6

V) Oxidation of N,N -disubstituted hydroxylamines using a variety of oxidizing agents such as, molecular oxygen,⁴⁴ yellow mercuric oxide,⁴⁵ potassium permanganate,⁴⁶ *t*-butyl hydroperoxide,⁴⁷ hydrogen peroxide,⁴⁸ *N-t*-butylbenzenesulfinimidoyl chloride in presence of DBU⁴⁹ as well as the electrochemical oxidation of N,N -disubstituted hydroxylamines⁵⁰ will lead to the formation of nitrones in excellent yields. These oxidation procedures are

generally used when the appropriate hydroxylamines are available (Scheme 2.7).

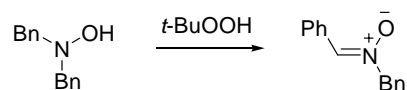

Scheme 2.7

VI) Oxidation of secondary amines can also produce nitrones. The reagents generally used for the oxidation of secondary amines to nitrones are peroxides in the presence of sodium tungstate⁵¹ or selenium dioxide⁵² as catalyst. Urea-hydrogen peroxide complex (UHP) in presence of sodium tungstate,⁵³ and dimethyldioxirane is another oxidant system.⁵⁴ Murray *et al.* found that, methyltrioxorhenium/hydrogen peroxide system is superior than dimethyldioxirane and can effectively oxidize secondary amines to the corresponding nitrones in excellent yields.⁵⁵ According to Stappers *et al.*, *m*-CPBA is an elegant and scalable alternative oxidant regarding safety, yield, and easy workup procedures for amine oxidation.⁵⁶ Very recently, a group from Spain reported an absolutely metal-free general procedure for the oxidation of secondary amines to nitrones (Scheme 2.8).⁵⁷

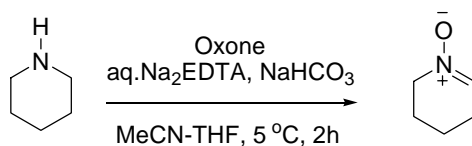

Scheme 2.8

Taking into account of our target nitrones, the availability of the chemicals, and easy work-up procedures, we selected method I, *i.e.*, the

condensation of diazo compounds with nitrosoarenes as a method for the synthesis of α,α,N -triarylnitrones. The imine oxidation with *m*-CPBA, *i.e.*, method II was selected for the preparation of *N*-fluorenylidene-*N*-(2,6-dimethylphenyl)nitrone. Method VI, *i.e.*, the one-pot synthesis of nitrones was selected for the production of α,N -diarylnitrones.

2.3. Results and Discussion

With a view to examine 1,3-dipolar cycloaddition reactions of nitrones with dibenzoylacetylene and the effect of substituents on α -C of the nitrones, we selected a few nitrones as given in the Figure 2.4 for our present study.

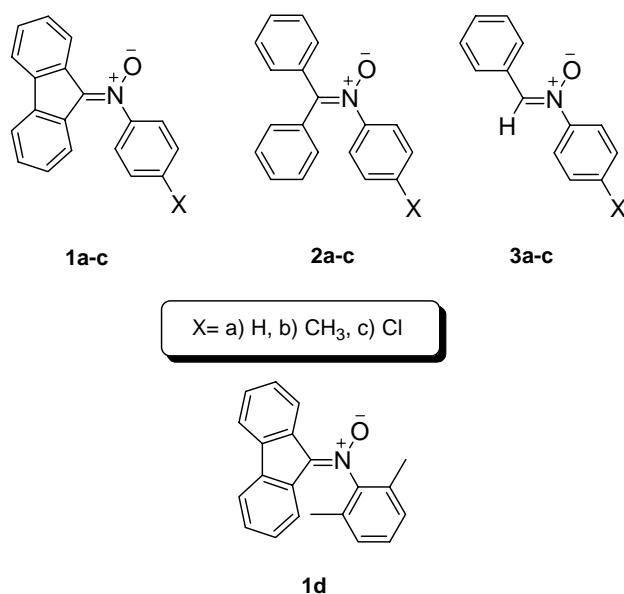
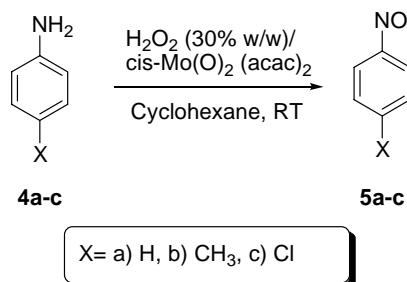

Figure 2.4

2.3.1. Synthesis of *N*-Fluorenylidene-*N*-arylnitrones

N-Fluorenylidene-*N*-arylnitrones **1a-c** were prepared by the condensation of nitrosoarenes with 9-diazofluorene. The required

nitrosoarenes **5a-c** were prepared by the very simple protocol developed by Porta *et al.* utilizing oxidation of aromatic primary amines **4a-c** using H₂O₂ (30% w/w) in presence of catalytic amount of *cis*-Mo(O)₂(acac)₂ at room temperature under aerobic conditions (Scheme 2.9).⁵⁸ The catalyst *cis*-Mo(O)₂(acac)₂ (1 mmol) in cyclohexane (50 mL) was stirred for about 10 min at room temperature under aerobic condition. The amine (10 mmol) followed by H₂O₂ (50 mmol) were added to the light orange suspension thus produced and stirred for about another 1h under aerobic condition. The reaction mixture was then filtered and dried over anhydrous Na₂SO₄. The solution was concentrated and cooled (<0 °C). When the solid mass obtained was allowed to melt, pure nitroso derivatives got precipitated.



Scheme 2.9

This method substantially simplified the procedure for the preparation of *C*-nitroso compounds by eliminating the conventional lengthy procedure which involves the reduction of aromatic nitro compounds of the corresponding phenylhydroxylamines followed by oxidation and purification by steam distillation.⁵⁹

9-Diazo fluorene⁶⁰ was prepared by the oxidation of the fluorenone hydrazones with mercuric oxide (HgO) (Scheme 2.10).⁶¹

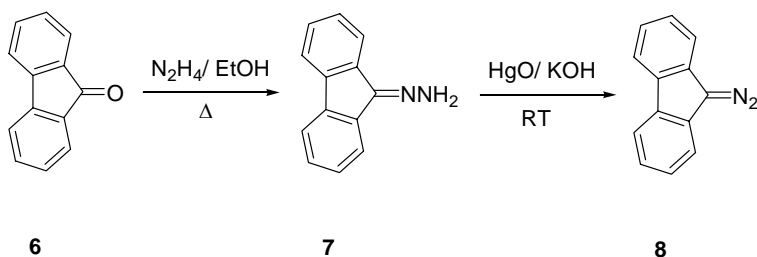

Scheme 2.10

N-Fluorenylidene-*N*-arylnitrones **1a-b** were quantitatively prepared by the reaction between diazofluorene and the corresponding nitrosoarenes. The reaction was rather fast with nitrogen elimination. The yellow precipitate formed was recrystallised from ethyl alcohol to give the corresponding fluorenylnitrones **1a-c** in good yields (Scheme 2.11).^{40,41} The compounds were identified on the basis of their spectral and analytical data.

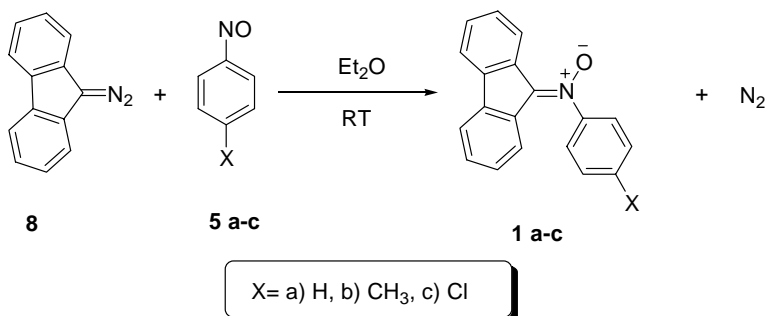

Scheme 2.11

2.3.2. Synthesis of *N*-Diphenylmethylene-*N*-arylnitrones

N-Diphenylmethylene-*N*-arylnitrones **2a-c** were prepared by the condensation of nitrosoarenes **5a-c** with diphenyldiazomethane (**9**) at RT. (Scheme 2.12).⁴⁰ Compounds **2a-c** were identified on the basis of their spectral and analytical data.

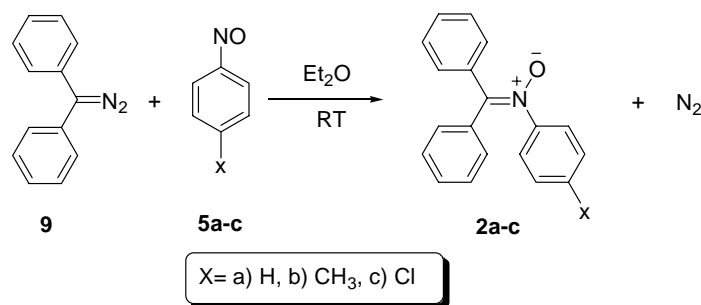

Scheme 2.12

Diphenyldiazomethane required for the synthesis of nitrones was obtained by the oxidation of benzophenone hydrazone (**11**) with mercuric oxide (Scheme 2.13).⁶¹

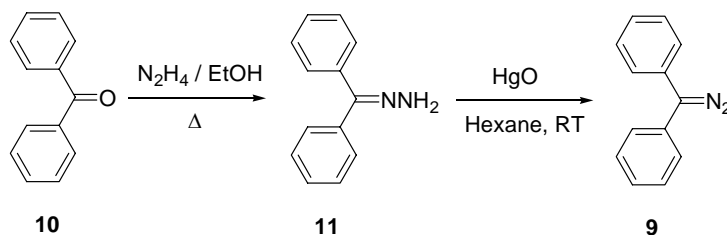

Scheme 2.13

2.3.3. Synthesis of *N*-Phenylmethylene-*N*-arylnitrones

In order to study the effect of steric hindrance at α -C of nitronium during the course of 1,3-dipolar cycloaddition reaction, we synthesized a few aldonitrones as well. (*Z*)-*N*-Phenylmethylene-*N*-arylnitrones **3a-c** were prepared by a one-pot synthesis developed by Chapoulaud *et al.*⁴³ Zinc mediated reduction of nitroarenes **13a-c** in the presence of benzaldehyde **12** produced diarylnitrones **3a-c** quantitatively (Scheme 2.14).⁶²

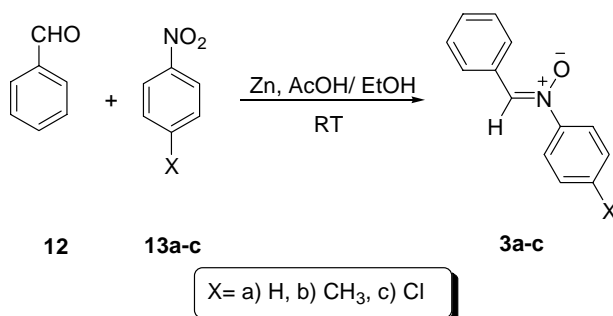

Scheme 2.14

2.3.4. Synthesis of *N*-Fluorenylidene-*N*-(2,6-dimethylphenyl)nitronium

In an attempt to study the course of dipolar cycloadditions of nitrones with acetylenes, we synthesised *N*-fluorenylidene-*N*-(2,6-dimethylphenyl)nitronium (**1d**). It was conveniently prepared by a two step procedure. The first step is preparation of corresponding imine **15**⁶³ followed by its oxidation with *m*-CPBA.⁴¹ Imine **15** was prepared by refluxing a mixture of fluorenone and 2,6-dimethylaniline in chloroform in presence of boron trifluoride etherate for about 15 min. The resulting solution was concentrated and cooled. The residue obtained was recrystallized from a 1:3 mixture of chloroform-ethanol to give yellow crystals of *N*-fluorenylidene-*N*-(2,6-dimethylphenyl) amine (**15**) in better yields (Scheme 2.15).

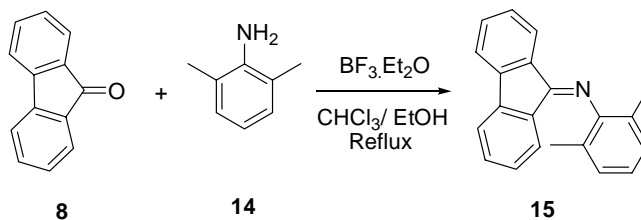

Scheme 2.15

Spectral and analytical data obtained for imine **15** were in perfect agreement with the structure. IR spectrum of imine **15** shows an absorption at

1656 cm^{-1} which is a characteristic of C=N stretching. IR absorptions at 734 and 768 cm^{-1} may be due to C-H out-of-plane vibrations of 1,2-disubstituted as well as 1,2,3-trisubstituted phenyl rings. ^1H NMR spectrum exhibited a characteristic signal for H-8 of fluorene ring at δ 6.52 ppm. The signal for this proton is substantially upfield-shifted due to its falling in the shielding cone of N-aryl group. Signal for H-1 (δ 8.06 ppm) is downfield-shifted with respect to the remaining aromatic protons due to the anisotropy exhibited by C=N bond. ^{13}C NMR signal at δ 163 ppm is of the C-9 of fluorene ring. Figures 2.5-2.7 represent the ^1H NMR, ^{13}C NMR and DEPT-45 spectra respectively of imine **15**.

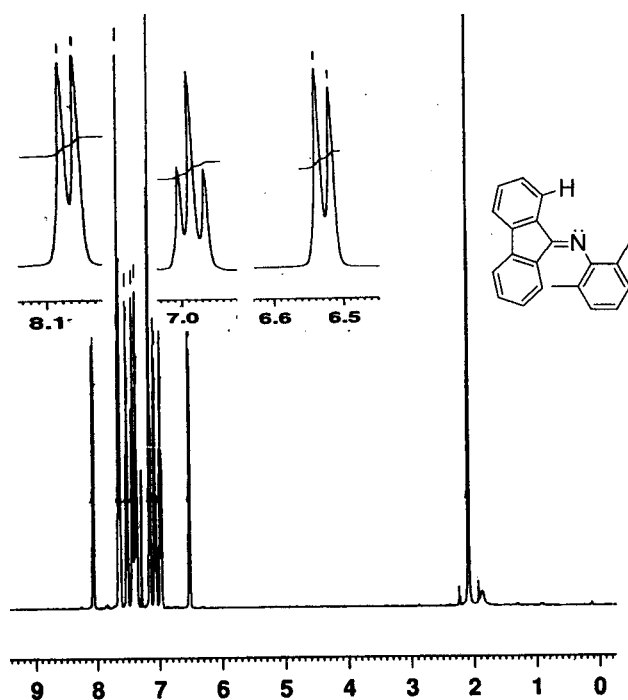

Figure 2.5 ^1H NMR spectrum of **15**

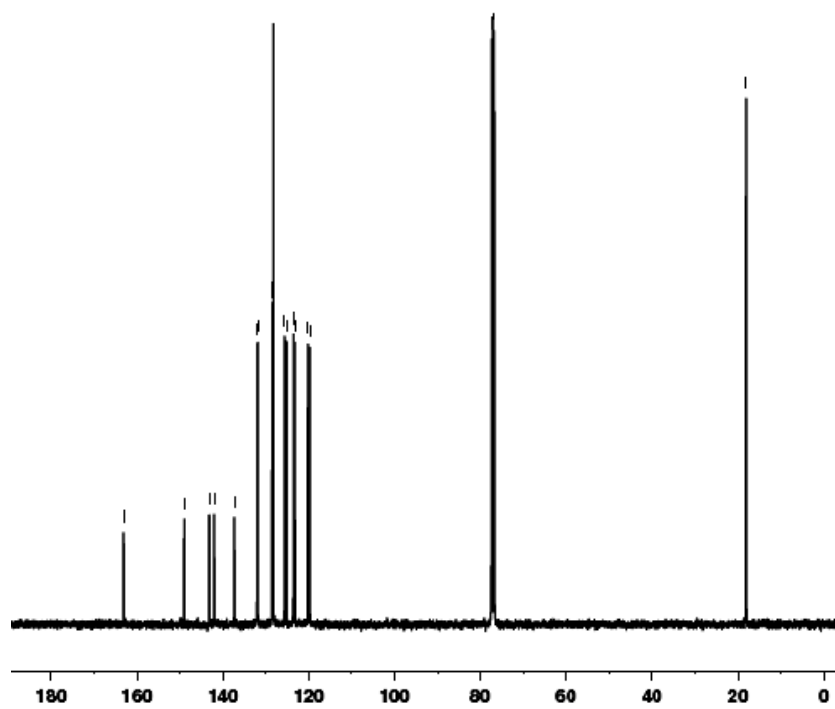

Figure 2.6 ^{13}C NMR spectrum of **15**

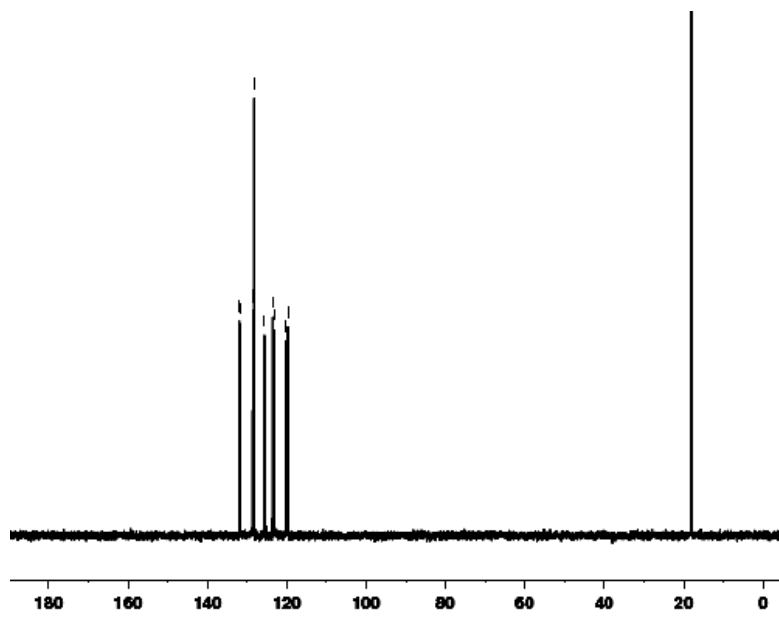
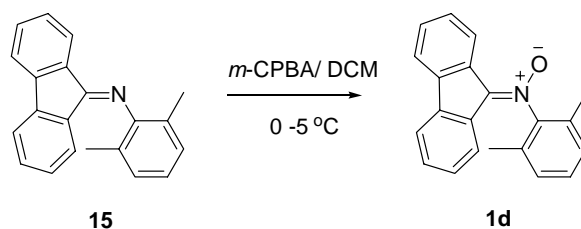

Figure 2.7 ^{13}C DEPT-45 spectrum of **15**

Nitronone **1d**, was prepared by the oxidation of a solution of *N*-fluorenylidene-*N*-(2,6-dimethylphenyl) amine (**15**) in DCM with a small excess of *m*-CPBA at a low temperature (0-5 °C). The crude product obtained was recrystallized from a 1:1 mixture of dichloromethane-hexane to give nitronone **1d** in good yield (Scheme 2.16).



Scheme 2.16

Spectral and analytical data obtained for nitronone **1d** are in good agreement with proposed structure. IR spectrum of nitronone **1d** shows absorptions at 1540 cm^{-1} which is a characteristic stretching frequency of C=N in nitronone group and at 1255 cm^{-1} due to the N→O stretching.⁴¹ IR absorptions at 725 and 768 cm^{-1} are due to C-H out-of-plane vibrations of 1,2-disubstituted as well as 1,2,3-trisubstituted phenyl rings. In the ¹H NMR spectrum, the peak at δ 9.01(d, 1H) is characteristic of fluorenylnitronone. The presence of negatively charged oxygen in the vicinity of *H-1* is responsible for its down field shifting than remaining aromatic protons. Upfield shift of *H-7* and *H-8* of the fluorene ring (δ 6.94 and 5.75 ppm respectively) may be due to its proximity to the shielding cone of *N*-aryl group as seen in the case of imine **15**. ¹³C NMR chemical shift of *C-9* of fluorene ring at δ 145.7 ppm is typical for fluorenylnitronones.⁴¹ MS data as well as elemental analysis are in agreement with its structure. Figures 2.8-2.10 represent the ¹H NMR, ¹³C NMR and DEPT-45 spectra respectively of the nitronone **1d**.

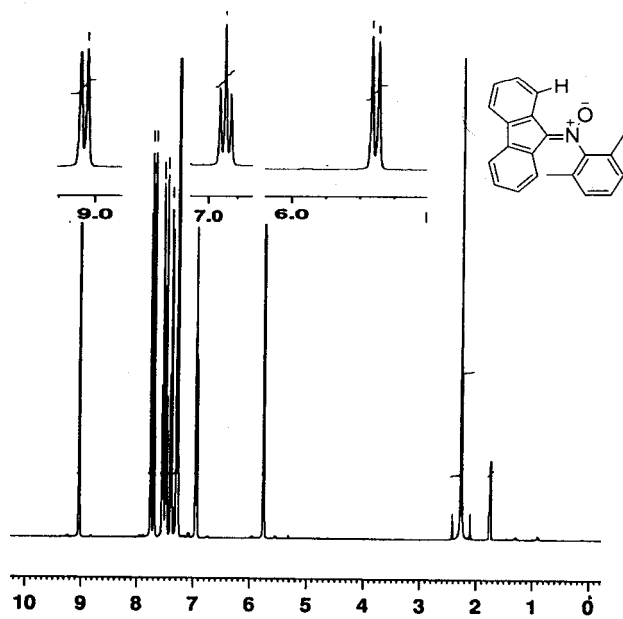

Figure 2.8 ^1H NMR spectrum of **1d**

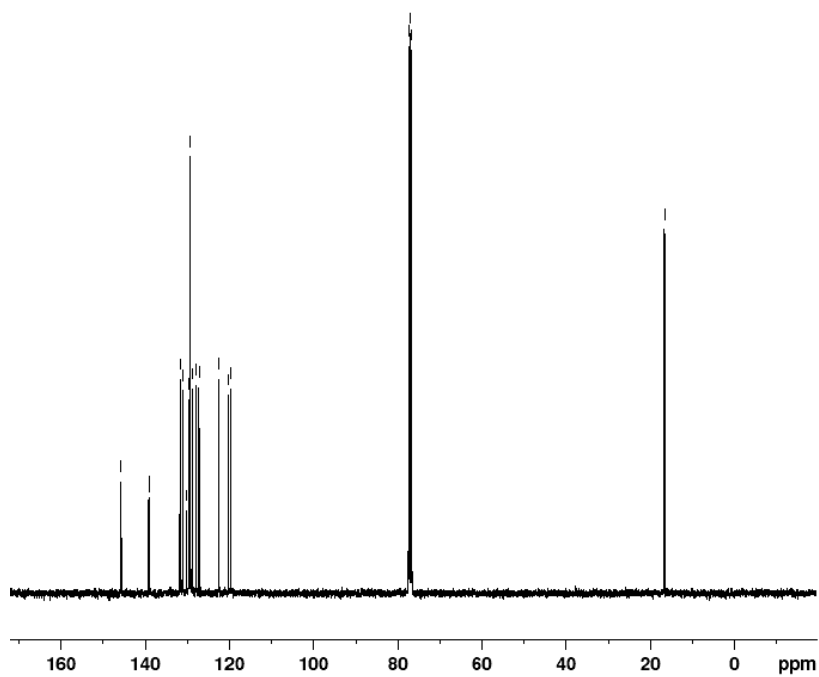

Figure 2.9 ^{13}C NMR spectrum of **1d**

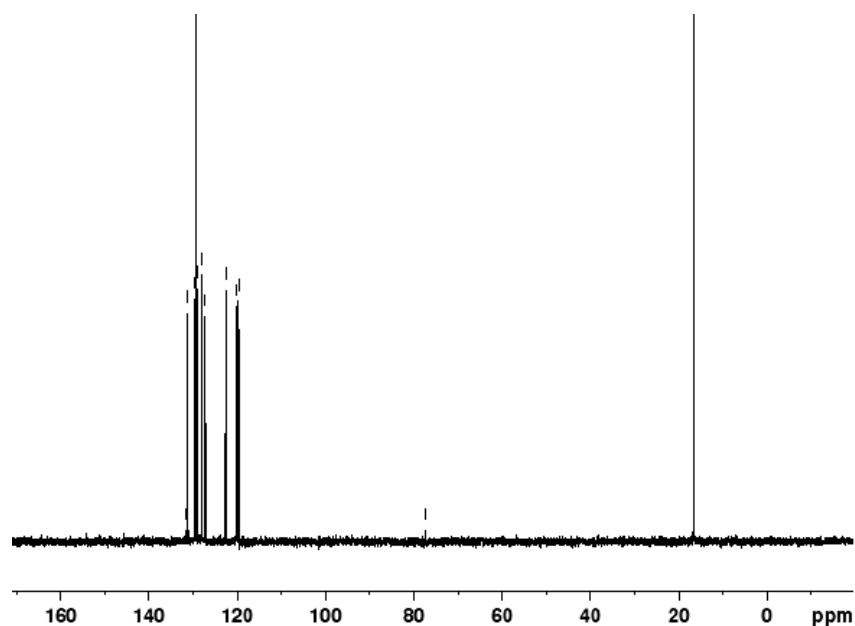

Figure 2.10 ^{13}C DEPT-45 spectrum of **1d**

2.4. Experimental Section

2.4.1. General Techniques

All reactions were carried out in oven dried glassware. Solvents used for the experiments were distilled and dried by employing standard protocols. All starting materials were purchased either from *Sigma-Aldrich* or from *S. D. Fine Chemicals* and were used without further purification. Progress of the reactions was monitored with the help of thin layer chromatography using dried and activated silica gel TLC plates (Aluminium sheets coated with silica gel, *E. Merck*). Visualisation of TLC plates was done by exposure to iodine vapours or UV lamp. Separation and purification of compounds were done by column chromatography using silica gel (*S.D. Fine Chemicals*, 60-120 mesh). Mixtures of ethyl acetate and hexane were used as the eluent. After chromatographic separation, solvent was removed using

Heidolph rotary evaporator. The products were further purified by recrystallization from appropriate solvent system. Melting points were recorded on *Neolab* melting point apparatus and are uncorrected. Elemental analysis was performed on *Elementar Systeme (Vario EL III)*. FAB mass spectra were recorded on JEOL JMS 600. IR spectra were recorded on *ABB Bomem (MB Series)* FT-IR spectrometer. ^1H and ^{13}C NMR spectra were recorded at 400 and 100 MHz on *Bruker* FT-NMR spectrometer using CDCl_3 as the solvent. Chemical shifts are given in δ scale with TMS as internal standard.

2.4.2. Nitrosobenzene (5a):

Nitrosobenzene was prepared by a known procedure. (78 % yield, mp 68 °C).⁵⁸

2.4.3. 4-Methylnitrosobenzene (5b):

4-Methylnitrosobenzene was synthesised by a known procedure (79 % yield, mp 48 °C).⁵⁸

2.4.4. 4-Chloronitrosobenzene (5c):

4-Chloronitrosobenzene was prepared by a known procedure (80% yield, mp 90 °C).⁵⁸

2.4.5. Fluorenone hydrazone (7):

Fluorenone hydrazone was prepared by a reported procedure (81% yield, mp 148 °C).⁶¹

2.4.6. 9-Diazo fluorene (8):

9-Diazo fluorene was prepared by a literature procedure (85% yield, mp 94 °C).⁶⁰

2.4.7. Benzophenone hydrazone (10):

Benzophenone hydrazone was prepared by a known procedure (80% yield, mp 95 °C).⁶¹

2.4.8. Diphenyldiazomethane (11):

Diphenyldiazomethane was prepared by a known procedure [Since the compound has a low mp and less stable in solid state, its concentrated solution (pink coloured) in hexane stored under low temperature was used for synthesis of nitrones].⁵⁸

2.4.9. N-Fluorenylidene-N-phenylnitrone (1a):

N-Fluorenylidene-N-phenylnitrone was prepared by a reported procedure (85%, mp 194 °C).⁴⁰

2.4.10. N-Fluorenylidene-N-(4-methylphenyl)nitrone (1b):

N-Fluorenylidene-N-(4-methylphenyl)nitrone was prepared by a known procedure (83% yield, mp 164 °C).⁴⁰

2.4.11. N-Fluorenylidene-N-(4-chlorophenyl)nitrone (1c):

A mixture of diazo fluorene (1.92 g, 10 mmol) and 4-chloro-nitrosobenzene (1.40 g, 10 mmol) in 40 mL of dry diethyl ether was stirred for about 1h. During the course of reaction red color of solution got vanished, nitrogen was evolved, and an yellow precipitate was formed. The precipitate

formed was filtered, dried and recrystallized from ethanol to give yellow crystals of *N*-fluorenylidene-*N*-(4-chlorophenyl)nitron (1c).

Yield 2.60 g, 85%; mp 206 °C

IR ν_{\max} (KBr): 1542 (C=N), 1249 (N→O), 729, 768, 829 and 867 cm^{-1} (aromatic C-H out of plane bending);

^1H NMR (CDCl_3): δ 8.87 (d, 1H), 7.25-7.70 (m, 9H), 6.94 (t, 1H), 6.03 (d, 1H);

^{13}C NMR (CDCl_3): δ 146.01, 139.20, 138.92, 131.65, 131.19, 130.30, 129.52, 129.34, 128.90, 128.82, 127.74, 127.22, 122.40, 120.14, 120.04;

MS: m/z calculated for $\text{C}_{19}\text{H}_{12}\text{ClNO}$: 305 (M^+); measured: m/z 306 (M^++1), 307.

Elemental analysis calculated for $\text{C}_{19}\text{H}_{12}\text{ClNO}$: C, 74.64; H, 3.96; Cl, 11.60, N, 4.58, O, 5.23%; found: C, 74.55; H, 3.98; N, 4.57%.

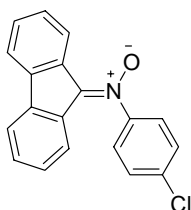

2.4.12. *N*-Diphenylmethylene-*N*-phenylnitron (2a):

N-Diphenylmethylene-*N*-phenylnitron was prepared by a known procedure (78% yield, mp 224 °C).⁴⁰

2.4.13. *N*-Diphenylmethylene-*N*-(4-methylphenyl)nitron (2b):

A concentrated solution of diphenyldiazomethane in hexane was added drop wise to a solution of 4-methylnitrosobenzene (1.20 g, 10 mmol) in 40 mL of dry diethyl ether with vigorous stirring till the reaction mixture turned pale pink in colour. It was stirred for about 1h. Additional amount of diphenyldiazomethane was added until the pink color persisted. The precipitate formed was filtered and washed with hexane to remove excess

amount of diphenyldiazomethane. The precipitate was then dried and purified by recrystallization from ethanol to give colorless crystals of *N*-diphenylmethylene-*N*-(4-methylphenyl)nitronne (**2b**)

Yield 2.30 g, 80% yield; mp 145 °C

IR (KBr) ν_{\max} : 1498 (C=N), 1236 cm^{-1} (N→O);

^1H NMR (CDCl_3): δ 8.02 (m, 2H), 6.99 -7.37 (m, 12H), 2.28 (s, 3H);

^{13}C NMR (CDCl_3): δ 147.72, 146.84, 136.21, 134.16, 133.90, 131.07, 130.51, 130.32, 128.95, 128.92, 128.49, 127.98, 125.98, 20.08;

MS: m/z calculated for $\text{C}_{20}\text{H}_{17}\text{NO}$: 287 (M^+); measured: m/z 288 (M^++1);

Elemental analysis calculated for $\text{C}_{20}\text{H}_{17}\text{NO}$: C, 83.59; H, 5.96; N, 4.87; O, 5.57%; found: C, 83.55; H, 6.01; N, 4.85%.

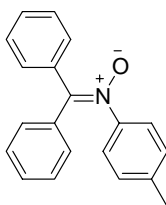

2.4.14. *N*-Diphenylmethylene-*N*-(4-chlorophenyl)nitronne (**2c**):

Diphenyldiazomethane (a highly concentrated solution in hexane) was added drop wise to a solution of 4-chloronitrosobenzene (1.40 g, 10 mmol) in 40 mL of dry diethyl ether with vigorous stirring till the reaction mixture turned to pale pink in colour. It was stirred for about 1h. Additional amount of diphenyldiazomethane was added until the pink color persisted. The precipitate formed was filtered and washed with hexane to remove excess amount of diphenyldiazomethane. The precipitate was then dried and recrystallized from ethanol to give colorless crystals of *N*-diphenylmethylene-*N*-(4-chlorophenyl)nitronne (**2c**).

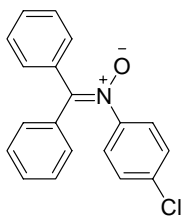

Yield 2.30 g., 75% yield; mp 186 °C

IR (KBr) ν_{\max} : 1542 (C=N), 1249 cm^{-1} (N \rightarrow O);

^1H NMR (CDCl_3): δ 8.04 (m, 2H), 7.10 -7.39 (m, 12H);

^{13}C NMR (CDCl_3): δ 147.77, 147.03, 135.39, 134.17, 133.90, 131.09, 130.52, 130.32, 128.98, 128.90, 128.49, 127.98, 125.96;

MS: m/z calculated for $\text{C}_{19}\text{H}_{14}\text{ClNO}$: 307 (M^+); measured: m/z 308 (M^++1), 309.

Elemental analysis calculated for $\text{C}_{19}\text{H}_{14}\text{ClNO}$: C, 74.15; H, 4.58; Cl, 11.52; N, 4.55; O, 5.20%; found: C, 74.02; H, 4.57; N, 4.56%.

2.4.15. (Z)-N-Phenylmethylene-N-phenylnitronium ion (3a):

(Z)-N-Phenylmethylene-N-phenylnitronium ion was prepared by a reported procedure (80%, mp 114 °C).⁴³

2.4.16. (Z)-N-Phenylmethylene-N-(4-methylphenyl)nitronium ion (3b):

(Z)-N-Phenylmethylene-N-(4-methylphenyl)nitronium ion was prepared by a known procedure (80%, mp 123 °C).⁴³

2.4.17. (Z)-N-phenylmethylene-N-(4-chlorophenyl)nitronium ion (3c):

(Z)-N-phenylmethylene-N-(4-chlorophenyl)nitronium ion was prepared by a known procedure (83%, mp 181 °C).⁴³

2.4.18. *N*-Fluorenylidene-*N*-(2,6-dimethylphenyl) amine (15):

A solution of fluorenone (1.80 g, 10 mmol), 2,6-dimethylaniline (2 g, 16 mmol) and boron trifluoride etherate (0.5 mL) in 30 mL of chloroform containing ethanol (5 mL) was refluxed for about 15 minutes. The resulting solution was then concentrated to about 10 mL. The residue obtained on cooling was recrystallized from a 1:3 mixture of chloroform-ethanol to give yellow crystals of *N*-fluorenylidene-*N*-(2,6-dimethylphenyl) amine (**15**) in very good yield.

Yield 2.60 g, 90%; mp 120 °C

IR (KBr) ν_{\max} : 1656 (C=N), 734 and 768 cm^{-1} (aromatic C-H out of plane bending);

$^1\text{H NMR}$ (CDCl_3): δ 8.06 (d, 1H), 7.07-7.65 (m, 8H), 6.98 (t, 1H), 6.52 (d, 1H), 2.26 (s, 6H);

$^{13}\text{C NMR}$ (CDCl_3): δ 163.06, 148.98, 143.10, 141.98, 137.27, 132.08, 131.99, 131.84, 128.52, 128.48, 128.22, 125.60, 125.09, 123.52, 123.24, 120.15, 119.72, 18.07;

MS: m/z calculated for $\text{C}_{21}\text{H}_{17}\text{N}$: 283 (M^+); measured: m/z 284 (M^++1);

Elemental analysis calculated for $\text{C}_{21}\text{H}_{17}\text{N}$: C, 89.01; H, 6.05; N, 4.94%; found: C, 89.03; H, 6.01; N, 4.96%.

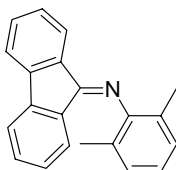
**2.4.19. *N*-Fluorenylidene-*N*-(2,6-dimethylphenyl)nitron (1d):**

A small excess of *m*-CPBA (1.80 g, 11 mmol) in 20 mL of dichloromethane was added with stirring and cooling (0-5 °C) to a solution of

N-fluorenylidene-*N*-(2,6-dimethylphenyl) amine (**15**) (2.83 g, 10 mmol) in 5 mL of DCM. After the addition of *m*-CPBA was complete, the mixture was stirred for about 5 h at 0-5 °C. The reaction mixture was then filtered and filtrate was washed twice with Na₂CO₃ solution and finally with water. After the filtrate was dried over anhydrous Na₂SO₄, organic layer was separated and evaporated. The residue obtained was recrystallized from a mixture (1:1) of dichloromethane-hexane to afford *N*-fluorenylidene-*N*-(2,6-dimethylphenyl)-nitrone (**1d**) in good yield.

Yield 2.40 g, 78%; mp 154 °C

IR (KBr) ν_{\max} : 1540 (C=N), 1255 (N→O), 725 and 768 cm⁻¹ (aromatic C-H out of plane bending);

¹H NMR (CDCl₃): δ 9.01 (d, 1H), 7.26-7.74 (m, 8H), 6.94 (t, 1H), 5.75 (d, 1H), 2.26 (s, 6H);

¹³C NMR (CDCl₃): δ 145.74, 139.16, 131.78, 131.56, 131.19, 130.26, 129.65, 129.31, 128.90, 127.98, 127.23, 122.56, 120.25, 119.66, 16.62;

MS: *m/z* calculated for C₂₁H₁₇NO: 299 (M⁺); measured: *m/z* 300 (M⁺+1);

Elemental analysis calculated for C₂₁H₁₇NO: C, 84.25; H, 5.72; N, 4.68; O, 5.34%; found: C, 84.22; H, 5.73; N, 4.67%.

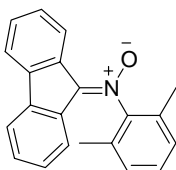

2.5. References

1. Hamer, J.; Macaluso, A. *Chem. Rev.* **1964**, *64*, 473.
2. Jones, R. C. F.; Martin, J. N. Nitrones. In *Synthetic Applications of 1,3-Dipolar Cycloaddition Chemistry Towards Heterocycles and Natural Products*, Padwa, A.; Pearson, W. H., Ed., *John Wiley and sons Inc.: New York*, **2002**, pp 1.
3. R. Huisgen, *Angew. Chem., Int. Ed. Engl.* **1963**, *2*, 565.
4. Huisgen, R. *Chem. Ber.* **1969**, *102*, 1102.
5. Beckmann, E. *Ber. Dtsch. Chem. Ges.* **1894**, *27*, 1957.
6. Smith, L. I. *Chem. Rev.* **1938**, *23*, 193.
7. Pfeiffer, P. *Annalen.* **1916**, *72*.
8. Semper, L.; Lichtenstadt, L. *Ber.* **1918**, *51*, 928.
9. Sutton, L. E.; Taylor, T. W. J. *J. Chem. Soc.* **1931**, 2190.
10. Barrow, F.; Thorneycroft, F. J. *J. Chem. Soc.* **1934**, 722.
11. Splitter, J. S.; Su, T. M.; Ono, H.; Calvin, M. *J. Am. Chem. Soc.* **1971**, *93*, 4075.
12. Gothelf, K. V.; Hazell, R. G.; Jorgensen, K. A. *J. Org. Chem.* **1996**, *61*, 346.
13. Libuori A.; Ottana R.; Romeo G.; Sindona G.; Uccella N. *Tetrahedron* **1988**, *44*, 1247.

14. Canterbury, D. P.; Frontier, A. J.; Um, J. M.; Cheong, P. H. Y., Goldfeld, D. A.; Huhn, R. A.; Houk, K. N. *Org. Lett.* **2008**, *10*, 4567.
15. Houk, K. N.; Sims, J.; Duke, R. E.; Strozier, R. W.; George, J. K. *J. Am. Chem. Soc.* **1973**, *95*, 7287.
16. Houk, K. N.; Sims, J.; Watts, C. R.; Luskus, L. J. *J. Am. Chem. Soc.* **1973**, *95*, 7301.
17. Sims, J.; Houk, K. N. *J. Am. Chem. Soc.* **1973**, *95*, 5798.
18. Tufariello, J. J.; Asrof Ali, S.; Klingele, H. O. *J. Org. Chem.* **1979**, *44*, 4213.
19. Knobloch, K.; Eberbach, W. *Org. Lett.* **2000**, *2*, 1117.
20. Abou-Garbia, M. A.; Joullie, M. M. *Heterocycles* **1979**, *12*, 819.
21. Coskun, N.; Parlar, A. *Synth. Commun.* **2006**, *36*, 997.
22. Goerdeler, J.; Schimpf, R. *Chem. Ber.* **1973**, *106*, 1496.
23. Coskun, N.; Tat, F. T. *Phosphorus, Sulfur and Silicon* **2003**, *178*, 881.
24. Coskun, N.; Tat, F. T. *Turk. J. Chem.* **2004**, *28*, 1.
25. Hermkens, P. H. H.; Maarseveen, J. H. V.; Kruse, C. G.; Scheeren, H. W. *Tetrahedron* **1988**, *44*, 6491.
26. Atkins, G. M.; Burgess, E. M. *J. Am. Chem. Soc.* **1968**, *90*, 4744.
27. Sajitha *et al.* Unpublished results from this laboratory.
28. Acken, B. J.; Warshaw, J. A.; Gallis, D. E.; Crist, D. R. *J. Org. Chem.*

- 1989**, 54, 1743.
29. Iwamura, M.; Inamoto, N. *Bull. Chem. Soc. Jap.* **1967**, 40, 702.
 30. Iwamura, M.; Inamoto, N. *Bull. Chem. Soc. Jap.* **1970**, 43, 856.
 31. Kotake, Y.; Janzen, E. G. *J. Am. Chem. Soc.* **1991**, 113, 9503.
 32. Janzen, E. G.; Kotake, Y.; Hinton, R. D. *Free Rad. Biol. Med.* **1992**, 12, 169.
 33. Hassan, W. N.; Castelevetri, I. C.; Denisova, N. A.; Yee, A. S.; Joseph, J. A.; Paulson, K. E. *Free Rad. Biol. Med.* **2002**, 32, 551.
 34. Hensley, K.; Carney, J. M.; Stewart, C. A.; Tabafabaie, T.; Pye, Q.; Floyd, R. A. *Int. Rev. Neurobiol.* **1999**, 40, 299.
 35. Taniguchi, H.; Madden, K. P. *Rad. Res.* **2000**, 153, 447.
 36. Samuni, A.; Murali Krishna, C.; Riesz, P.; Finkelstein, E.; Russo, A. *Free Rad. Biol. Med.* **1989**, 6, 141.
 37. Zhao, H.; Joseph, J.; Zhang, H.; Karoui, H.; Kalyanaraman, B. *Free Radical Biol. Med.* **2001**, 31, 599.
 38. Nakae, D.; Kishida, H.; Enami, T.; Konishi, Y.; Hensley, K. L.; Floyd, R. A.; Kotake, Y. *Cancer Sci.* **2003**, 94, 26.
 39. Floyd, R. A. *Aging Cell*, **2006**, 5, 51.
 40. Johnson, A. W. *J. Org. Chem.* **1963**, 28, 252.
 41. Abou-Gharbia, M. A.; Joullie, M. M. *J. Org. Chem.* **1979**, 44, 2961.

42. Christensen, D.; Jorgensen, K. A. *J. Org. Chem.* **1989**, *54*, 126.
43. Chapoulaud, V. G.; Pandya, S. U.; Cividino, P.; Masson, G.; Py, S.; Vallee, Y. *Synlett.* **2001**, *8*, 1281.
44. Jondon, D. H.; Rogers, M. A. T.; Trappe, G. *J. Chem. Soc.* **1956**, 1093.
45. Wragg, A. H.; Stevens, T. S. *J. Chem. Soc.* **1959**, 461.
46. Utzinger, G. E. *Annalen.* **1944**, *50*, 556.
47. De La Mare, H. E.; and Coppinger, G. M. *J. Org. Chem.* **1963**, *28*, 1068.
48. Thesing, J.; Muller, A.; Michel, G. *Ber.* **1955**, *88*, 1030.
49. Matsuo, J.; Shibata, T.; Kitagawa, H.; Mukaiyama, T. *Arkivoc* **2001**, *10*, 58.
50. Shono, T.; Matsumura, Y.; Inoue, K. *J. Org. Chem.* **1986**, *51*, 549.
51. Murahashi, S. I.; Mitsui, H.; Shiota, T.; Tsuda, T.; Watanabe, S. *J. Org. Chem.* **1990**, *55*, 1736.
52. Murahashi, S. I.; Shiota, T. *Tetrahedron Lett.* **1989**, *28*, 2383.
53. Markantoni, E.; Petrini, M.; Polimanti, O. *Tetrahedron Lett.* **1995**, *36*, 3561.
54. Murray, R. W.; Singh, M. *Synth. Commun.* **1989**, *19*, 3509.
55. Murray, R. W.; Iyanar, K.; Chen J.; Wearing, J. T. *J. Org. Chem.* **1996**, *61*, 8099.

56. Stappers, F.; Broeckx, R.; Leurs, S.; Bergh, L. V. D.; Agten, J.; Lambrechts, A.; Heuvel, D. V. D.; Smaele, D. D. *Org. Proc. Res. Dev.* **2002**, *6*, 911.
57. Gella, C.; Ferrer, E.; Alibes, R.; Busque, F.; March, P.; Figueredo, M.; Font, J. *J. Org. Chem.* **2009**, *74*, 6365.
58. Porta, F.; Prati, L. *J. Mol. Cat. A: Chem.* **2000**, *157*, 123.
59. Coleman, G. H.; McCloskey, C. M.; Stuart, F. A. *Org. Synth.* **1945**, *25*, 80.
60. Schonberg, A.; Awad, W. I.; Latif, N. *J. Chem. Soc.* **1951**, 1368.
61. Smith, L. I.; Howard, K. L. *Org. Synth.* **1944**, *24*, 53.
62. Wheeler, O. H.; Gore, P. H. *J. Am. Chem. Soc.* **1956**, *78*, 3363.
63. Taylor, M.; Fletcher, T. *J. Org. Chem.* **1961**, *26*, 940.

Chapter 3

1,3-DIPOLAR CYCLOADDITION REACTIONS OF NITRONES

3.1. Abstract

This chapter deals with the reactions of various nitrones with dibenzoylacetylene followed by the chemical transformations of the 1:1 adducts formed. The experimental observations are explained on the basis of a stepwise addition involving zwitterionic intermediates.

3.2. Introduction

1,3-Dipolar cycloaddition reactions constitute one of the most important classes of organic reactions. The ease of generation of various dipoles as well as the observed regio- and stereoselective nature of their addition to π -systems made 1,3-dipolar cycloaddition reactions a universal protocol for the synthesis of various heterocycles.¹⁻³ Nowadays, 1,3-dipolar cycloaddition reactions are employed in almost every sphere of chemistry, including, material chemistry, medicinal chemistry, biochemistry, etc.⁴⁻¹⁵

In the context of our general interest in developing novel classes of heterocycles by utilising various strategies,¹⁶⁻¹⁹ in the present study we employed 1,3-dipolar cycloaddition reactions as an excellent method for the synthesis of nitrogen and oxygen heterocycles.

1,3-Dipolar cycloaddition reaction of nitrones has attracted considerable attention as one of the most important methods for the construction of nitrogen and oxygen heterocycles.²⁰ Nitrones undergo facile cycloaddition reactions with alkenes and alkynes to yield isoxazolidines and isoxazolines respectively. For *e.g.*, reaction of *N-t*-butyl-*N*-methylenenitrone with dimethyl acetylenedicarboxylate at 0 °C leads to the formation of 4-isoxazoline.²¹ Due to thermal instability, presumably related to the presence of labile nitrogen-oxygen bond, the isoxazolines thus formed have a tendency to undergo rearrangements to various other products. Baldwin *et al.* reported the thermal isomerisation of 4-isoxazoline **3** formed during the reaction between *N*-2,4,6-trimethylphenyl-*N*-methylenenitrone (**1**) and dimethyl acetylenedicarboxylate (**2**) to the corresponding 4-oxazoline **5** via the acylaziridine intermediate **4** at 80 °C. He observed that, the reaction was quite rapid at RT in the case of *N*-arylnitrones and rate of conversion of 4-isoxazoline to acylaziridine was accelerated relative to the subsequent isomerisation to 4-oxazoline. This may be due to the fact that, an *N*-aryl substituent would be expected to further weaken the labile N–O bond. The 4-oxazoline, being a highly labile compound, readily hydrolysed to formaldehyde and enol **6** (mixture of *cis*- and *trans*-enols) with dil. HCl (Scheme **3.1**).²²

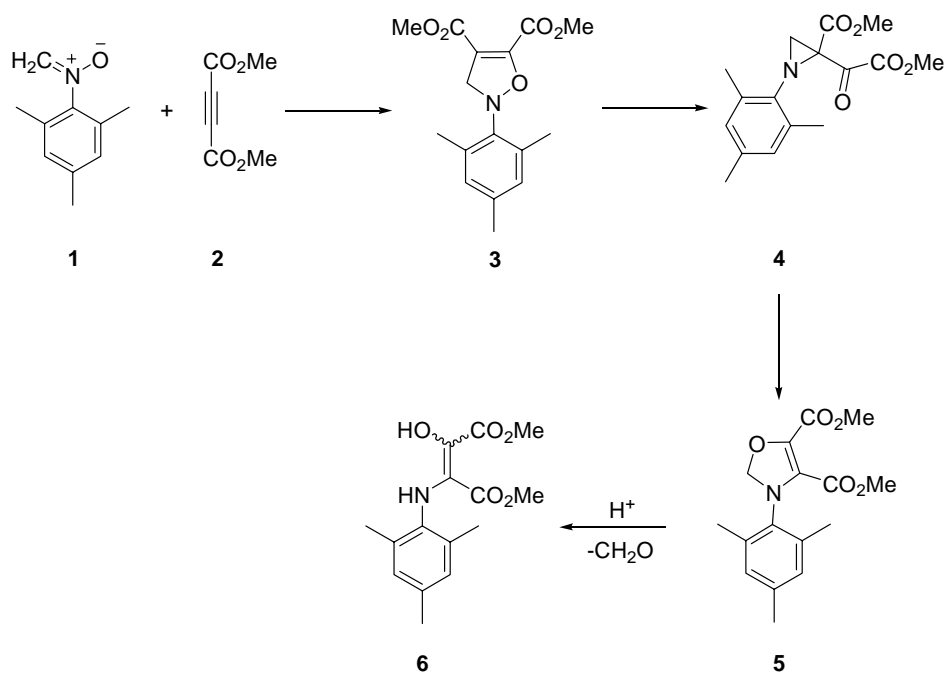

Scheme 3.1

Winterfeldt *et al.* reported yet another type of rearrangement of 4-isoxazolines to pyrroles.^{23,24} Upon cycloaddition with methyl propiolate (**8**), nitrone **7** gives 4-isoxazoline **9** that rearranges to a mixture of pyrroles **10** and **11** (Scheme 3.2). It is likely that **10** derived *via* the 2-acylaziridine rearrangement route (Path 1); whereas pyrrole **11** is assumed to be assembled by a reaction path involving a sequence of hydroxylamine formation, a hetero-Cope rearrangement, and finally cyclisation (Path 2). (See Sec. 3.3.10 for proposed stepwise mechanism)

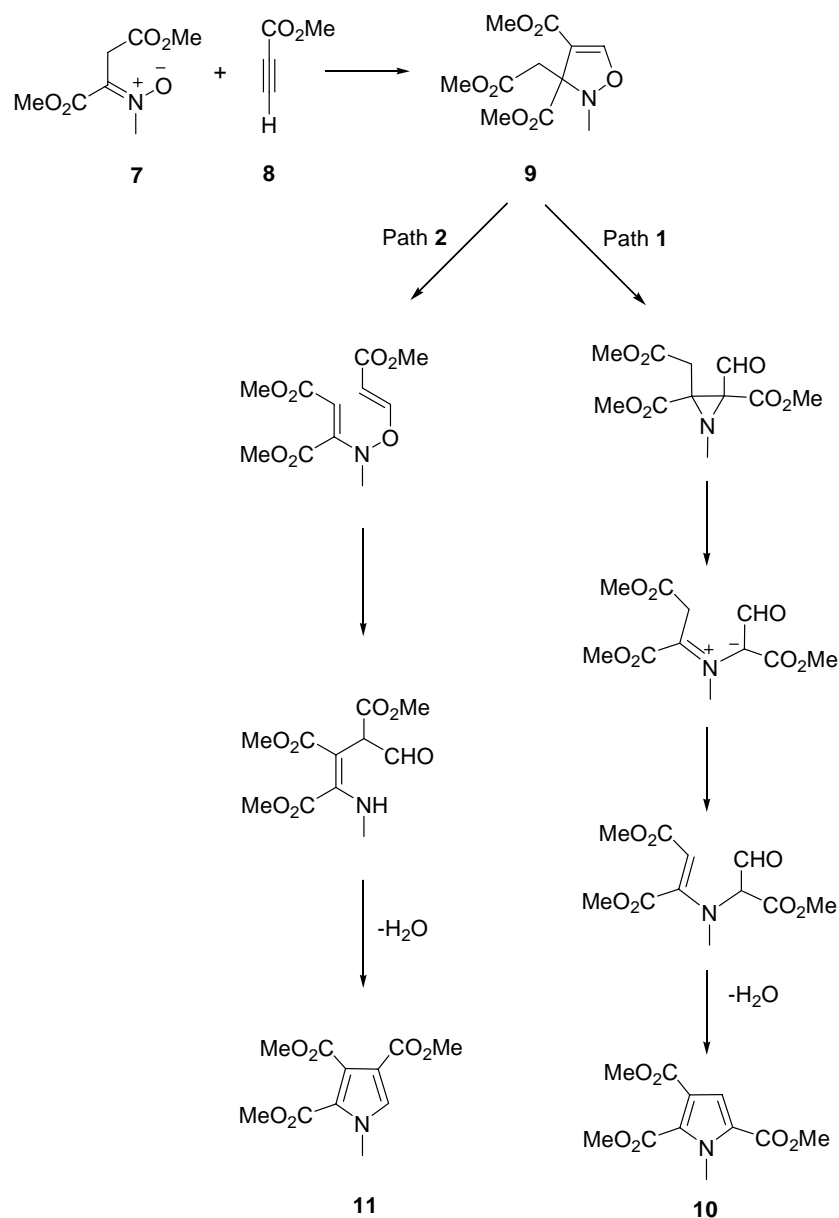

Scheme 3.2

Nitrones can also react with ketenes, ketenimines, isocyanates, isothiocyanates, *etc.* For *e.g.*, the reaction between *C,N*-diphenylnitrone (**12**) and diphenylketene **13** results in the formation of the phenylimino

5-alkylidenedihydrotriazoles **22**. The zwitterion **24** quantitatively affords tetrazine **26** via the elimination of nitrogen from the adduct **25** (Scheme 3.5).²⁹

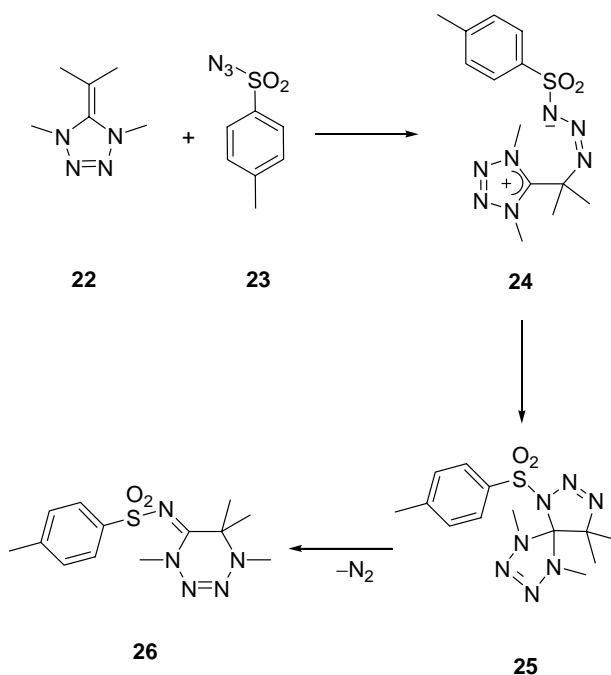

Scheme 3.5

From literature analysis, it is obvious that there is a lively debate on the mechanism of 1,3-dipolar cycloaddition reactions. Modest amount of theoretical work has also been performed on 1,3-dipolar addition mechanism. Most of the theoretical studies are focussed on the concerted nature of 1,3-dipolar cycloadditions.³⁰⁻³³ Some of the advanced computational studies carried out on different systems lead to the conclusion that the dipoles follow both concerted and stepwise paths and these paths may be in close competition.³⁴⁻³⁶ We reasoned that a 1,3-dipole that exhibits substantial nucleophilic character can undergo overall cycloaddition through a two step nucleophilic addition-ring closure sequence. The dipolarophile should ideally contain anion stabilizing groups that will make it an excellent

Michael acceptor. Nucleophilic character of nitrones is well established (*vide infra*) and dibenzoylacetylene is an excellent Michael acceptor. Thus, the reaction between suitable nitrones and dibenzoylacetylene should provide an ideal platform to examine competing nucleophilic addition-ring closure sequence and concerted 1,3-dipolar cycloaddition reaction. In the present chapter we describe our findings on the reaction of various nitrones with DBA. Contrary to conventional wisdom, the reactions yielded a different set of products. Their formation is better explained on the basis of a stepwise reaction involving zwitterionic intermediates. Our findings, thus, represent a breakthrough in the longstanding impasse on the mechanism of 1,3-dipolar cycloaddition.

3.3. Results and Discussion

In an attempt to study the mechanism involved in 1,3-dipolar cycloaddition reactions, we selected nitrones and dibenzoylacetylene (DBA) as the 1,3-dipole and dipolarophile respectively. While selecting the reaction between nitrones and DBA as a platform to investigate the mechanistic intricacies of 1,3-dipolar additions, as stated earlier, we bore the following points in mind: 1) nitrones undergo nucleophilic addition to ketenes and keteneimines, 2) DBA is an excellent Michael acceptor, and 3) the expected isoxazoline product generated in the reaction between nitrones and DBA is generally perceived to be unstable. Hence we reasoned that a stepwise mechanism is plausible for 1,3-dipolar addition of DBA to nitrones and dipolar intermediate generated in the putative Michael type addition step may have to cross a substantial energy barrier to overcome adverse steric interactions with α -C substituents and to undergo ring closure to give the presumably unstable isoxazoline derivatives (Scheme 3.6).

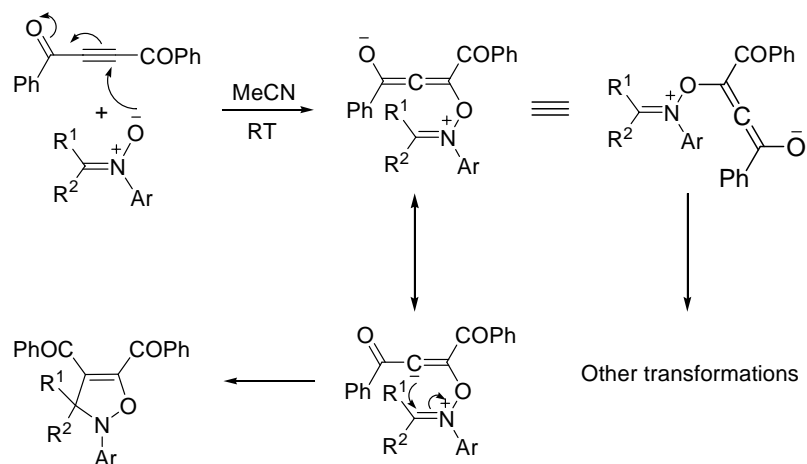

Scheme 3.6

Nitrones chosen for our present study are given in Figure 3.1. It is evident that, on moving from nitrones **27** to **29**, the steric crowding on α -C of nitrones is reduced which may affect the course of reaction. One of the reasons for the selection of DBA as dipolarophile is that, introduction of electron withdrawing substituents into an acetylenic dipolarophile will increase rate constants by several orders. Another reason is that, negative charge on the zwitterions, if formed, will be stabilized by anion stabilizing groups.

Dibenzoylacetylene was prepared by a known three step procedure.³⁷ The first step involves Friedel-Crafts acylation of benzene with fumaryl chloride to give *trans*-dibenzoyl ethylene, which on bromination followed by dehydrobromination using triethylamine give DBA quantitatively.

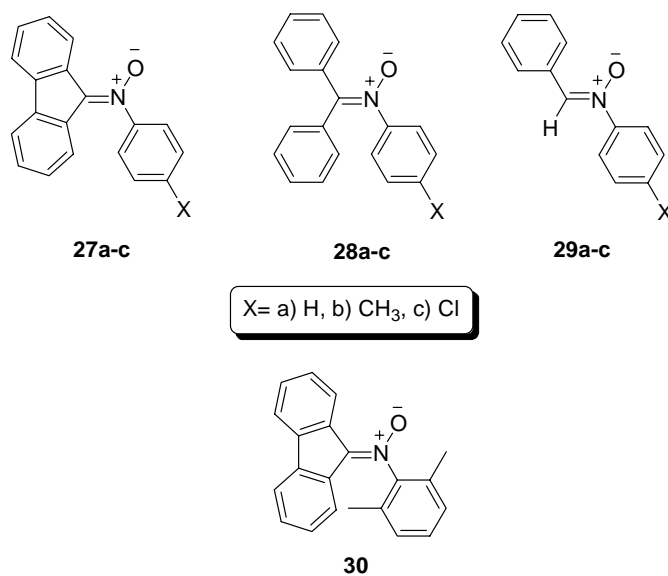
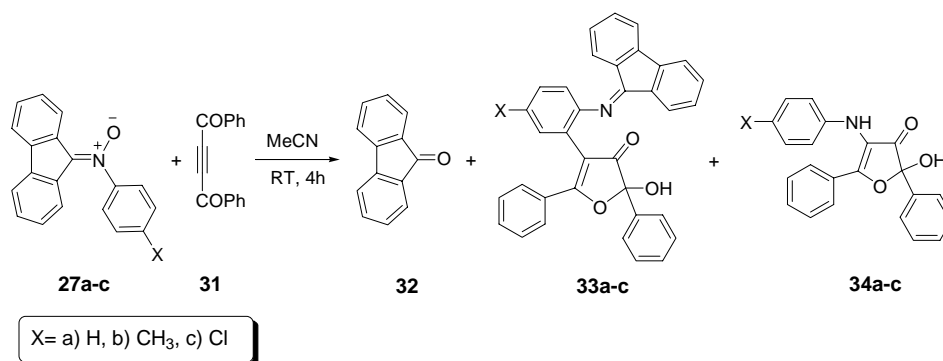

Figure 3.1

3.3.1. Reactions of *N*-Fluorenylidene-*N*-arylnitrones with DBA

1,3-Dipolar cycloaddition reaction between *N*-fluorenylidene-*N*-aryl nitrones **27a-c** and dibenzoylacetylene (**31**) is conducted in 1:1 molar ratio at RT in dry acetonitrile. It is found that the reaction is practically complete within 4 h. The reaction results in the formation of three products (Scheme 3.7). The overall conversion is found to be ~90% (wt %). CHN and MS data of the compounds reveal that one of the products is a 1:1 adduct and the sum of *m/z* values of other two compounds are found to be exactly equal to (1:1 adduct + H₂O) and are formed in 1:1 ratio. On the basis of spectral and analytical data the compound with smallest molecular mass (*M*+1 = 181) is identified as 9-fluorenone (**32**). The structure is further confirmed by comparing the spectral and analytical data of an authentic sample.



X	Product yield, %		
	32	33	34
H	13	75	14
CH ₃	14	76	16
Cl	14	73	15

Scheme 3.7

Spectral data indicate that 1:1 adduct is entirely different from normal products expected on the basis of a concerted process. The broad peak at $\sim 3250 \text{ cm}^{-1}$ in IR spectrum of these compounds indicates the presence of a hydrogen bonded $-\text{OH}$ (*not expected in the formal adduct*). It is supported by a small broad singlet $\sim \delta 4.2(\text{bs}, 0.4\text{H})$ in ^1H NMR spectrum which is vanished in the D_2O exchange experiment. The aromatic region in ^1H NMR spectrum shows a complex multiplet. The sharp peak at $\sim 1680 \text{ cm}^{-1}$ in IR spectrum indicates the presence of a single carbonyl group (*two carbonyl groups are expected in the formal adduct*). Presence of the lone carbonyl group is supported by the peak at $\sim \delta 198$ in ^{13}C NMR spectrum. On the basis of spectral and analytical data, the results of hydrolysis experiment carried on 1:1 adducts (details are presented in section 3.3.4.) as well as the nucleophilicity of nitrones and probability for a Michael-type addition of nitrones to acetylenes, the 1:1 adducts are identified as 3(2*H*)-furanones **33a-c**.

Conclusive evidence on the structure of 1:1 adducts emerged from X-ray diffraction studies. The single crystal X-ray diffraction analysis conducted on the crystals of **33a** and **33b**, unambiguously confirmed their proposed structure (Figure 3.2 and 3.3).

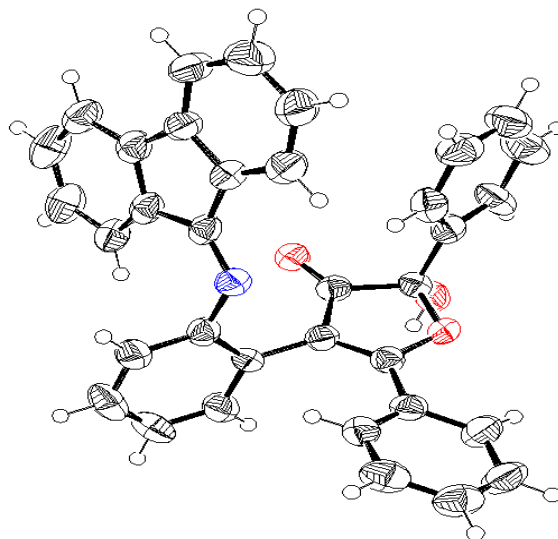

Figure 3.2 ORTEP diagram of molecular structure of compound **33a**

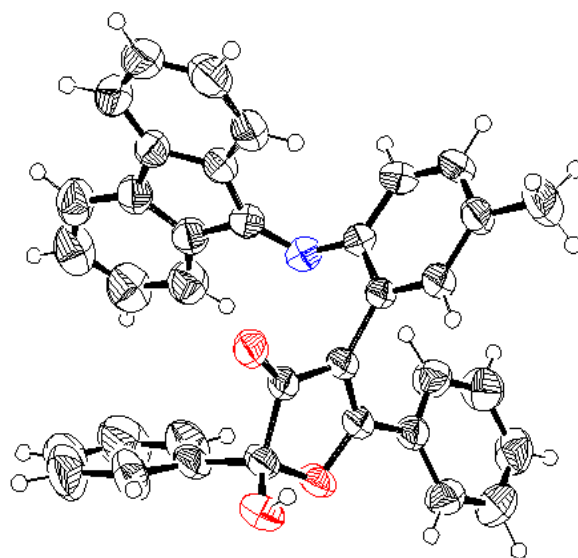

Figure 3.3 ORTEP diagram of molecular structure of compound **33b**

After identifying the structure of **33**, we focussed our attention on identifying the structure of the minor product **34** formed in the nitron-DBA reaction. As mentioned earlier, compound **34** and fluorenone are generated during the reaction in a 1:1 ratio suggesting that both are formed from the same entity. Additionally, the sum of m/z values of compound **34** and fluorenone is found to be exactly equal to (1:1 adduct + H₂O). So there is every possibility for a hydrolysis step in the course of overall reaction. Similar results have already been reported in literature.²² The possibility for the hydrolysis of 1:1 adducts **33a-c** was totally ruled out because it leads to the formation of other products (**3.3.4**). We also found that, compound **34a-c** is a common product irrespective of the substituents on α -C of nitrones (Ref. **3.3.6** and **3.3.8**). In the IR spectrum of compounds **34a-c**, there is a sharp peak at $\sim 3360\text{ cm}^{-1}$ and a broad peak at $\sim 3300\text{ cm}^{-1}$ indicating the presence of -OH and -NH groups. It is further confirmed by the small broad singlet at $\sim \delta 4.3$ (bs, 0.6H) and a comparatively sharp peak at $\sim \delta 5$ (s, 0.75H) in the ¹H NMR spectrum which are vanished in the D₂O exchange experiment. The aromatic region in the ¹H NMR spectrum extends from $\sim \delta 6.5$ to 8.0 as a multiplet. The sharp peak at $\sim 1675\text{ cm}^{-1}$ in the IR spectrum shows the presence of a carbonyl group and is supported by the peak at $\sim \delta 199$ in the ¹³C NMR spectrum. Obviously, the carbonyl carbon in compounds **34a-c** is in the same environment as that in compounds **33a-c**. Considering the spectral and analytical data, formation of **34a-c** and fluorenone in 1:1 ratio during the reaction, invariant generation of compounds **34a-c** irrespective of the substituents on α -C of nitrones, and the possibility for cyclisation of the zwitterionic intermediate formed by the Michael-type addition of nitrones to acetylenes, the compounds are identified as 3(2*H*)-furanones **34a-c**.

The single crystal X-ray diffraction analysis conducted on crystals of **34a**, unequivocally confirmed the proposed 3(2*H*)-furanone structure (Figure 3.4)

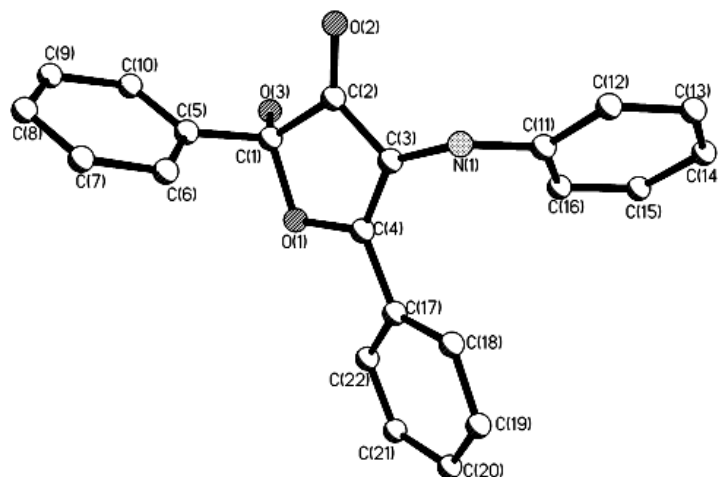

Figure 3.4 ORTEP diagram of molecular structure of compound **34a**

3(2*H*)-Furanones are widely distributed in nature and possess unusual range of biological activities.³⁸⁻⁴⁰ Several furanones exhibit tumor inhibitory properties.^{16,41} 3(2*H*)-Furanones are also used as selective COX-II inhibitors.^{42,43} The pharmacological importance of 3(2*H*)-furanones has led to the development of efficient methods for their synthesis. In this context, we recommend the reaction between nitrones and DBA as an alternate efficient method for the synthesis of novel 3(2*H*)-furanones (Ref. **3.3.8**).

3.3.2. Reactions of *N*-Fluorenylidene-*N*-arylnitrones with DBA in Refluxing Acetonitrile

When the reaction between nitrone **27a-c** and DBA was repeated under reflux conditions in acetonitrile, the reaction was found to be rather fast, and a slight variation in product distribution was noticed (Scheme **3.8**). We

observed an approximately 5% decrease in the percentage yield of 1:1 adducts with a proportionate increase in percentage yields of other two compounds. This indicates the presence of two competing pathways out of which one is energetically less favored compared to the other.

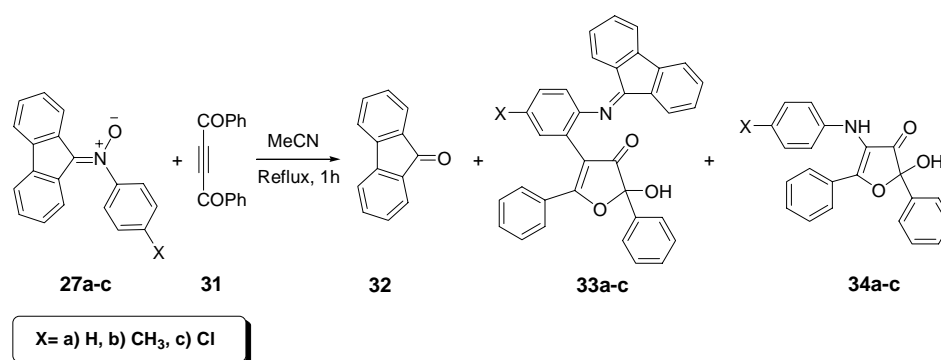

X	Product yield, %		
	32	33	34
H	17	68	18
CH ₃	20	69	19
Cl	18	66	22

Scheme 3.8

3.3.3. Proposed Mechanism for the Reactions of Nitrones with DBA – A Stepwise Reaction

Formation of compounds **32**, **33a-c** and **34a-c** can be explained on the basis of a stepwise addition mechanism. In the first step of reaction, a zwitterionic intermediate **35a-c** is formed by a Michael-type addition of nitrones **27a-c** to DBA. The zwitterionic intermediate can undergo either cyclisation to normal 1:1 adduct, *i.e.*, 4-isoxazolines **36a-c** or it can undergo a spontaneous hetero-Cope rearrangement {[3,3] sigmatropic rearrangement} followed by rearomatisation and cyclisation to give 3(2*H*)-furanones **33a-c**.

4-Isoxazolines are known to undergo isomerisation to the corresponding 4-oxazolines *via* an aziridine intermediate. As observed by Baldwin *et al.*, here the presence of *N*-aryl substituents may enhance the rate of conversion of 4-isoxazolines to 4-oxazolines. As described earlier, this may be due to the fact that, an *N*-aryl substituent would be expected to further weaken the N–O bond.²¹ 4-Oxazoline **37**, being a highly labile compound,²² may be readily hydrolysed to fluorenone (**32**) and enol **38a-c**. The latter on cyclisation will produce the 3(*2H*)-furanones **34a-c** (Scheme 3.9).

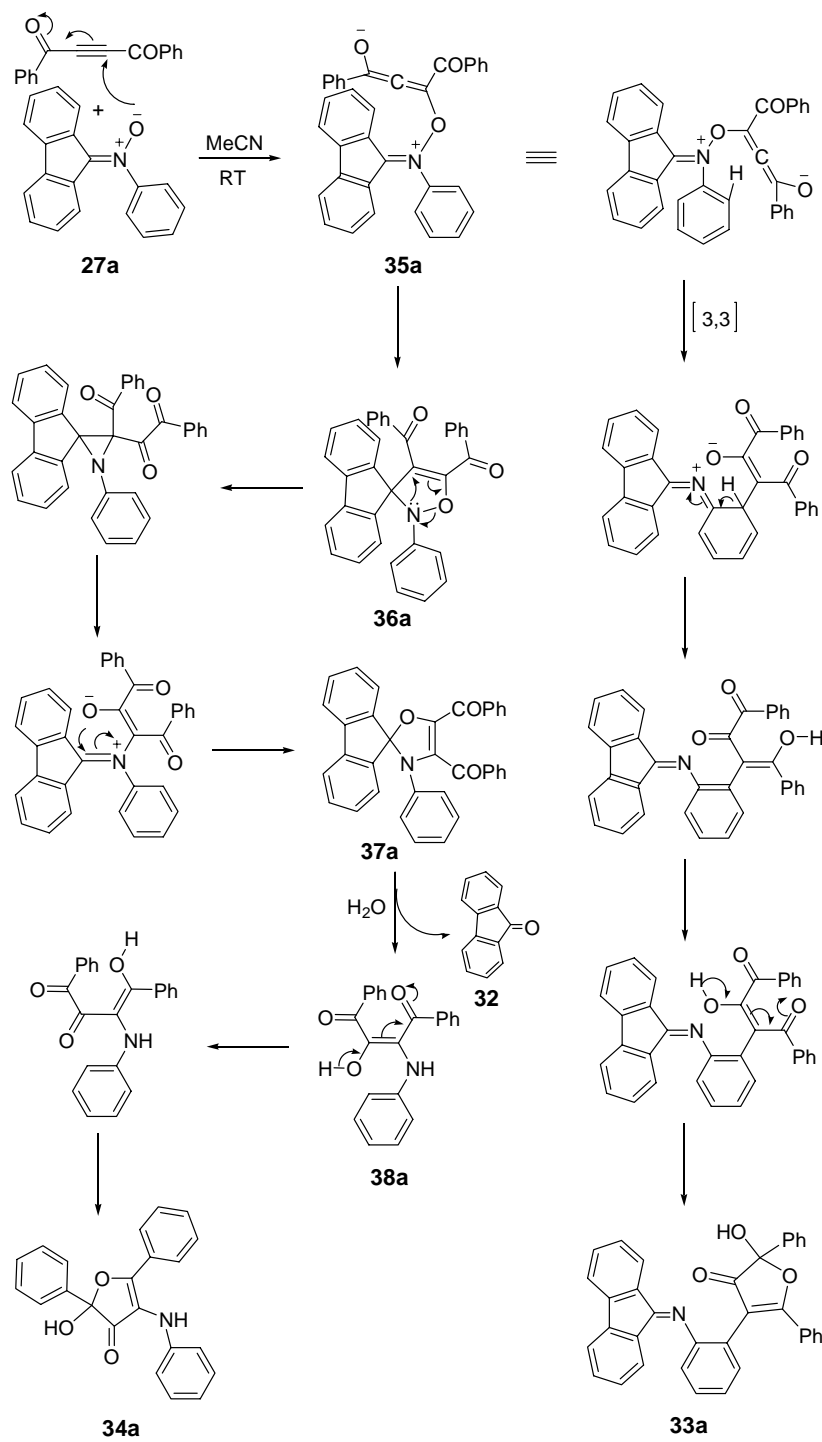

Scheme 3.9

In order to confirm the mechanism for the formation of 3(2*H*)-furanones **34** we repeated the reaction between **27** and **DBA** in acetonitrile containing water as well as in methanol. Water and methanol may intercept the zwitterionic intermediate **35** and that may lead to other products, for example fluorenone and isoxazoline **39** in presence of excess water (Scheme 3.10). However, no change in products/product distribution was observed under these conditions. Based on these results, we conclude that hydrolysis step manifests at a later stage in the reaction sequence as shown in the previous scheme.

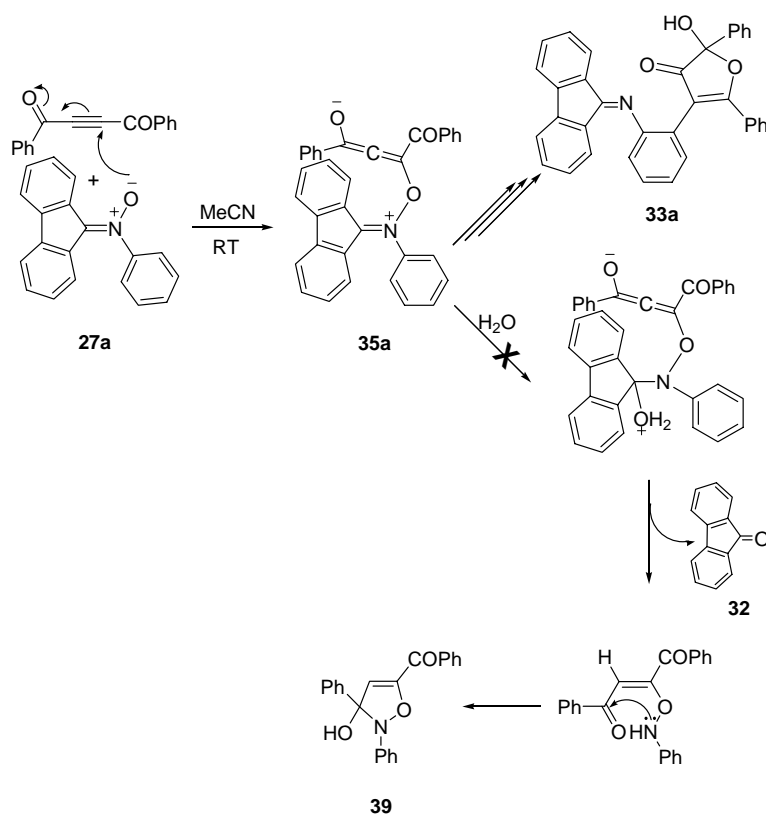

Scheme 3.10

3.3.4. Hydrolysis of *N*-Fluorenylidene-*N*-arylnitrone-DBA Adducts

In addition to spectral and analytical data, results from hydrolysis experiment carried on 1:1 adducts were also helpful to elucidate their structures. Note that hydrolysis experiment was mandatory to confirm that **34** was not generated by the hydrolysis of **33**. Hydrolysis was accomplished by stirring a mixture of 1:1 adducts **33a-c** and oxalic acid adsorbed on silica gel in DCM at RT for 2h (Scheme 3.11). The products were separated by column chromatography.

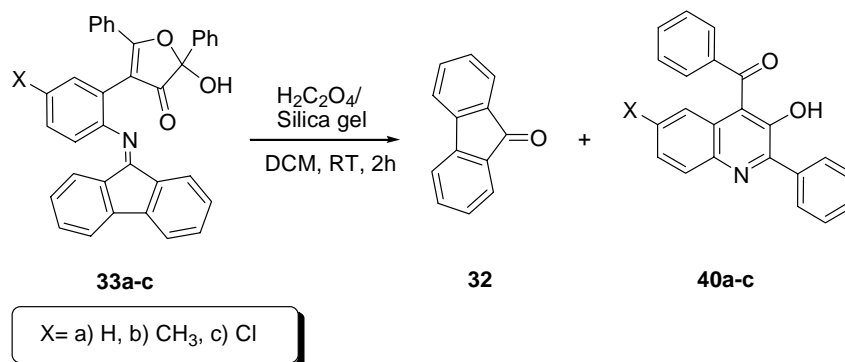

X	Product yield, %	
	32	40
H	86	90
CH ₃	89	87
Cl	88	91

Scheme 3.11

Acidic hydrolysis of **33** led to the formation of two compounds. One of the two products separated is identified as fluorenone. In the IR spectrum of other compound there is a broad peak at $\sim 3450\text{ cm}^{-1}$ indicating the presence of a hydrogen bonded $-\text{OH}$ group. Presence of a comparatively sharp peak at $\sim \delta 8.8$ (s, 0.54H) in ^1H NMR spectrum which is vanished in D_2O exchange

experiment reveals that, the compound may contain an enolic –OH. The aromatic region in ^1H NMR spectrum extends from $\sim \delta$ 7 to 8.0. The sharp peak at $\sim 1670\text{ cm}^{-1}$ in IR spectrum suggests the presence of a carbonyl group which is supported by the peak at $\sim \delta$ 198 in ^{13}C NMR spectrum. Based on spectral and analytical data, the compound is identified as quinoline **40a-c**.

Single crystal X-ray diffraction analysis conducted on crystals of **40b**, confirmed the structure of quinolines (Figure 3.5)

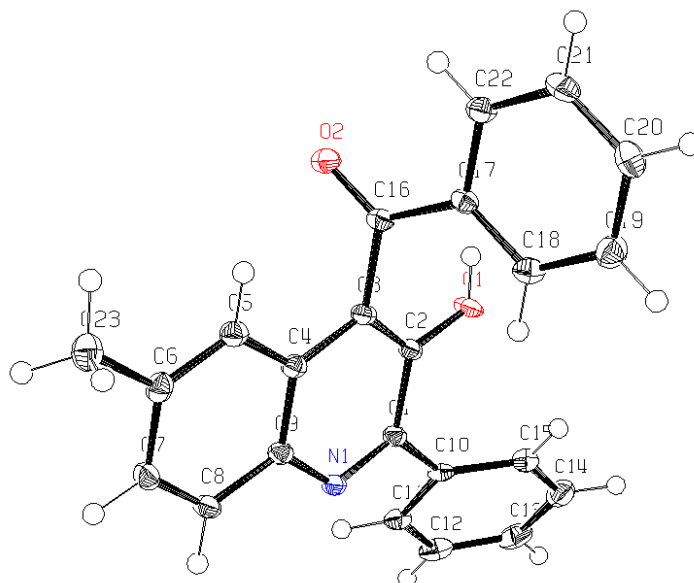
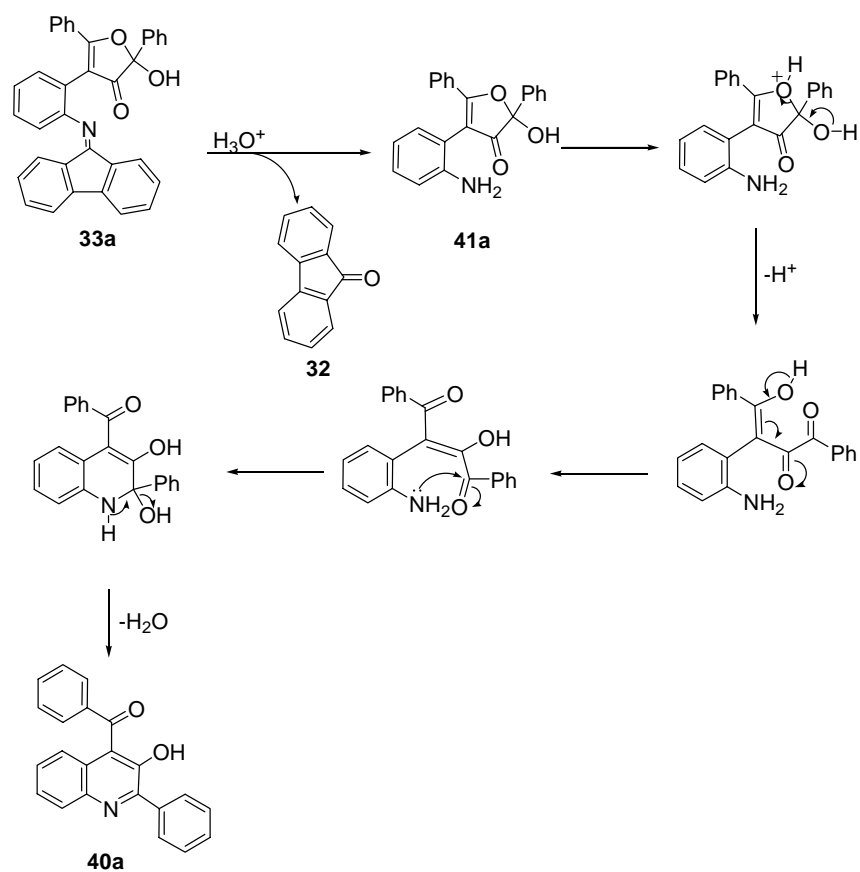

Figure 3.5 ORTEP diagram of molecular structure of compound **40b**

3.3.5. Proposed Mechanism for the Hydrolysis of *N*-Fluorenylidene-*N*-arylnitronone-DBA Adducts

Oxalic acid adsorbed on silica gel is commonly used for mild hydrolysis.^{18,44,45} The first step in the hydrolysis reaction is a typical imine hydrolysis to give the carbonyl part **32** (fluorenone in the present example) and the amine **41a-c**. The next step is ring opening of 3(2*H*)-furanone ring

system present in the amine component which is followed by re-cyclisation and aromatization to give quinoline **40a-c** (Scheme 3.12).



Scheme 3.12

As cited in sec. 3.3.1., the hydrolysis experiment is pivotal to elucidate the pretty complex structure of 1:1 adducts **33**. The disconnection approach leading us to the structure of 1:1 adducts is given in scheme 3.13.

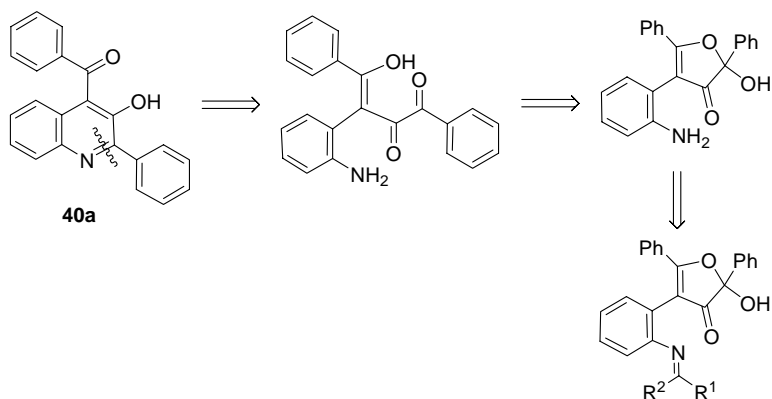

Scheme 3.13

3.3.6. Reactions of *N*-Diphenylmethylene-*N*-arylnitrones with DBA

1,3-Dipolar cycloaddition reaction between *N*-diphenylmethylene-*N*-arylnitrones **28a-c** and DBA is conducted in 1:1 molar ratio at RT in dry acetonitrile (Scheme 3.14).

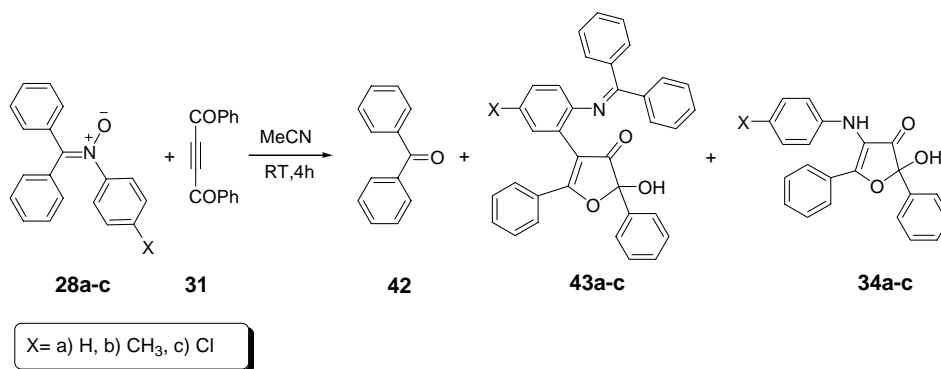

X	Product yield, %		
	42	43	34
H	24	66	23
CH ₃	21	64	20
Cl	23	66	22

Scheme 3.14

It is found that the reaction results in the formation of products similar to those obtained in the reaction between *N*-fluorenylidene-*N*-arylnitrones **27a-c** and DBA. One of the products formed is identified as 3(2*H*)-furanone **34a-c**. On the basis of spectral and analytical data the compound with smallest molecular mass ($M+1=183$) is identified as benzophenone (**42**). The structure of 1:1 adduct **43a-c** is determined on the basis of spectral and analytical data (for more details, see experimental section). The structure is further confirmed by their hydrolysis which leads to the formation of benzophenone and quinolines **40a-c** (**3.3.7**). There is a decrease in percentage yield of 1:1 adduct formed during the cycloaddition reaction (*i.e.*, 75% to 65%), on moving from *N*-fluorenylidene-*N*-aryl nitrones **27a-c** to *N*-diphenylmethylene-*N*-arylnitrones **28a-c** and this may be due to the decrease in steric barrier offered by the α -C of nitrone. This will enhance the probability for the cyclisation of zwitterionic intermediate formed as a result of the Michael-type addition of nitrones to DBA.

3.3.7. Hydrolysis of N-Diphenylmethylene-N-arylnitrone-DBA Adducts

As mentioned above, the structure of the 1:1 adducts **43a-c** is confirmed by the hydrolysis experiment. The hydrolysis with oxalic acid adsorbed on silica gel results in the formation of benzophenone and quinoline **40a-c** (Scheme **3.15**). The products are identified on the basis of their spectral and analytical data.

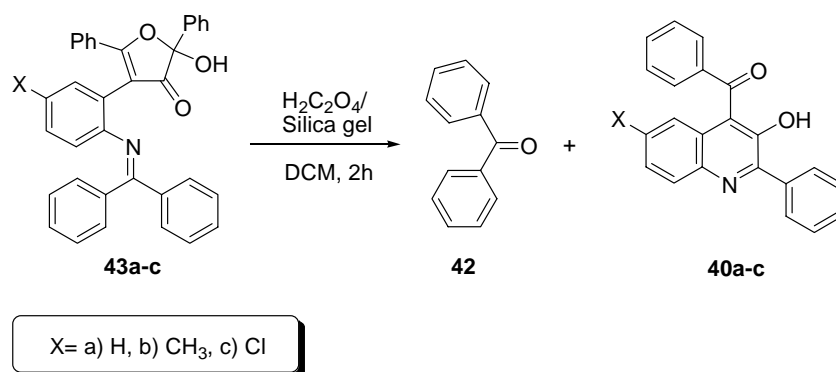

X	Product yield, %	
	42	40
H	83	82
CH ₃	81	85
Cl	78	81

Scheme 3.15

Quinoline ring system is widely distributed in nature. The alkaloid quinine is a well known traditional antimalarial drug. The presence of quinoline nucleus in the framework of various pharmacologically active compounds with antiasthmatic,⁴⁶ antibacterial,⁴⁷ antifungal,⁴⁸ antimalarial,⁴⁹ anti-viral,⁵⁰ anti-inflammatory⁵¹ activities triggered an active research in the realm of synthesis and transformations of quinolines. 8-Hydroxyquinoline is a versatile chelating agent. Its aluminium complex, tris-(8-hydroxy-quinolinato) aluminium(III), generally represented as **Alq₃**, is a commonly used compound in organic light emitting diodes (OLEDs).⁵² The presence of suitably placed carbonyl and hydroxyl groups in quinoline **40**, give rise to the possibility for their conversion to salen type compounds which can form metal complexes and make them synthetically attractive. Considering the synthetic as well as pharmacological potential of quinolines, herein we propose a synthetic loop for a highly atom efficient synthesis of highly substituted quinolines (Figure

3.6). It is possible to alter substitution pattern by the judicious selection of acetylenic compounds and appropriate amines (during the synthesis of nitrones).

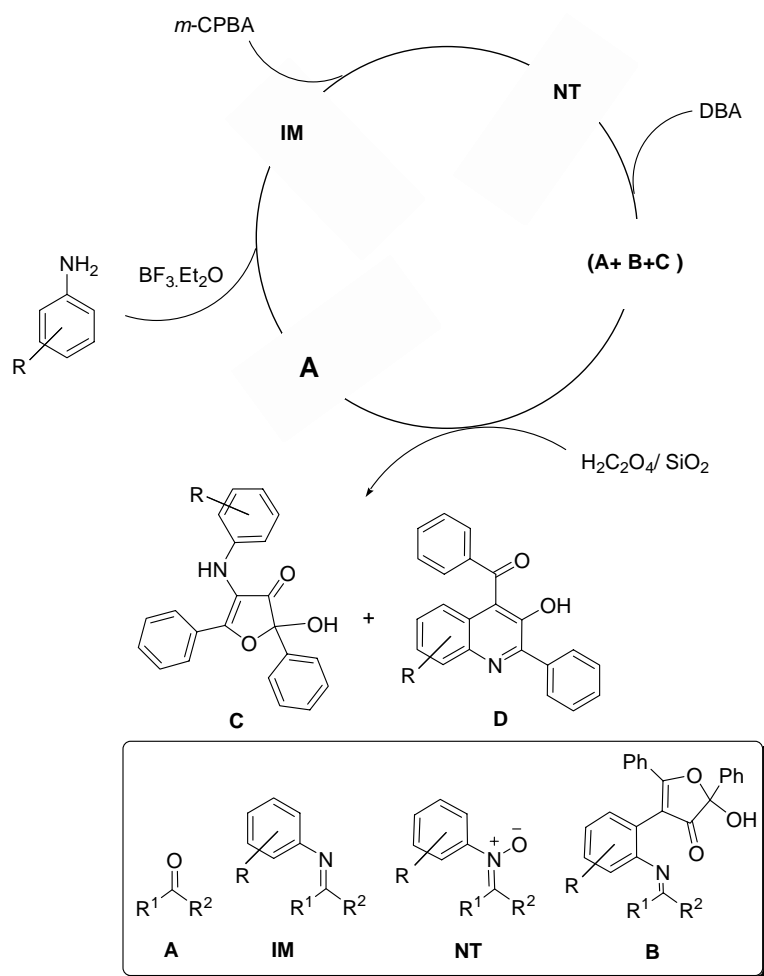
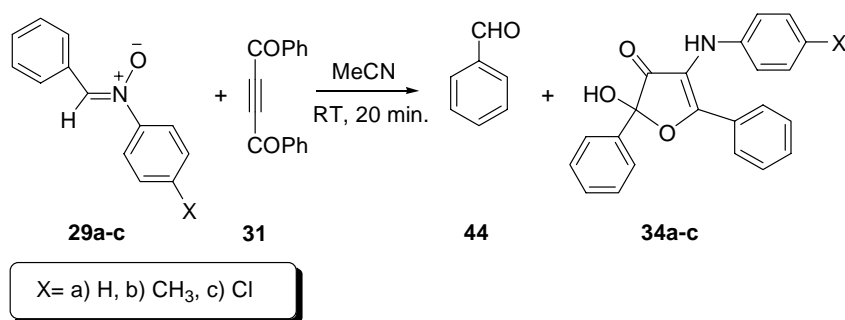

Figure 3.6 Proposed synthetic loop for the synthesis of quinolines

3.3.8. Reactions of *N*-Phenylmethylen-*N*-arylnitrones with DBA

The reaction between *N*-phenylmethylen-*N*-arylnitrones **29a-c** and dibenzoylacetylene was conducted in 1:1 molar ratio at RT in dry acetonitrile

(Scheme 3.16). In this case, reaction was found to be relatively fast and completed within a short interval (~20 min). Very interestingly, we noticed that, the expected 1:1 adduct was not formed in detectable amounts. We could isolate only two products from the reaction mixture. On the basis of spectral and analytical data they were identified as benzaldehyde (**44**) and 3(2*H*)-furanone **34a-c**. This can be explained on the basis of the geometry of the nitrones. In the case of *N*-fluorenylidene-*N*-arylnitrones, the fluorenyl ring and the *N*-aryl ring are almost orthogonal to each other {Ref. the ORTEP diagram of *N*-fluorenylidene-*N*-(4-methoxyphenyl) amine⁵³}. This arrangement will retard the overall rate of the reaction compared to *N*-phenylmethylene-*N*-arylnitrones which are supposed to be planar. Besides this, decrease in the steric barrier offered by α -C of *N*-phenylmethylene-*N*-arylnitrones compared to *N*-fluorenylidene-*N*-arylnitrones as well as *N*-diphenylmethylene-*N*-arylnitrones, switches the cyclisation of zwitterionic intermediate as the most favourable path.^{21,22}



X	Product yield, %	
	44	34
H	74	83
CH ₃	81	80
Cl	78	84

Scheme 3.16

3.3.9. Reactions of *N*-Fluorenylidene-*N*-(2,6-dimethylphenyl)nitronone with DBA

To verify the proposed mechanism of 1:1 adduct formation, we selected the reaction between *N*-fluorenylidene-*N*-(2,6-dimethylphenyl)nitronone (**30**) and DBA as a limiting experiment (Scheme **3.17**). In the case of **30**, [3,3]-sigmatropic shift is less likely for the initially generated 1,5-dipolar intermediate **45**. Even after prolonged stirring TLC analysis indicated the presence of unchanged reactants as major components in the reaction mixture. The product mixture was separated by silica gel column chromatography. The compounds separated were mainly nitronone and DBA along with two other compounds in small amounts. One of the products was identified as fluorenone and we have tentatively assigned the structure **46** for the second product. The results indicate that cyclisation of zwitterionic intermediate, to corresponding 4-isoxazoline, is not the preferred pathway. Furthermore, we propose that the initial nucleophilic addition step is reversible. Since the favored pathway *via* hetero-Cope rearrangement is blocked, most of the reactants remain unchanged. This observation provided further credence to the proposed mechanism involving a two-step process.

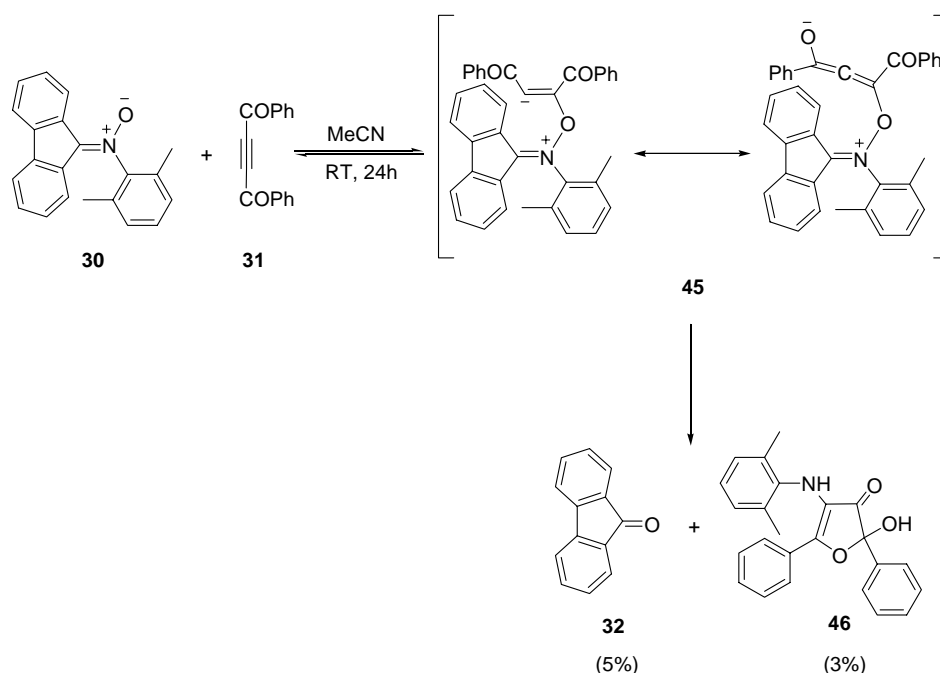

Scheme 3.17

3.3.10. Winterfeldt's Experiment Revisited – A Word of Caution

In the Introduction Section (Section 3.2), we had presented the observation by Winterfeldt *et al.* on the reaction between nitrones and methyl propiolate.^{23,24} He had *prima facie* assumed a 1,3-dipolar cycloaddition mechanism and intermediacy of isoxazoline **9** is in the generation of pyrrole **11**. Based on our findings, we propose an alternative mechanism to account for the generation of **11** (Scheme 3.18). We argue that the reaction between nitrone **7** and methyl propiolate (**8**) proceeds at least in part through a two step process involving initial nucleophilic addition type of pathway discovered by us. The dipolar intermediate **47** generated thereby can easily abstract a proton from the 3-position of the diester residue to give the hydroxylamine directly. The remaining steps involved are identical to those proposed by Winterfeldt *et al.*

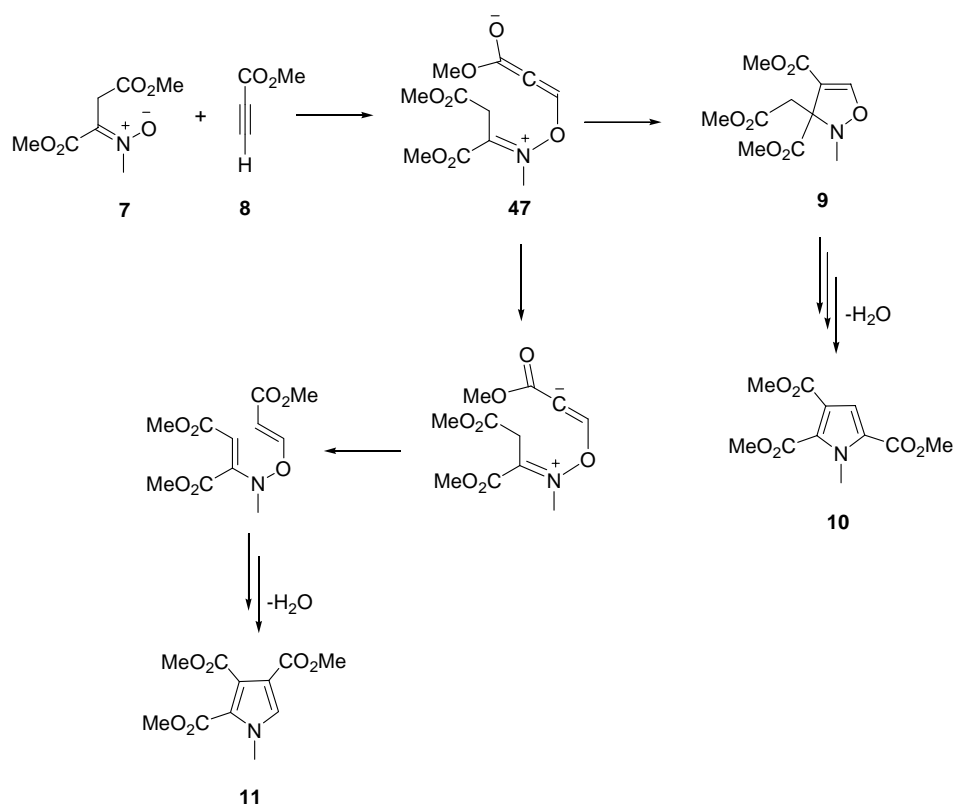

Scheme 3.18

In the past, investigators had taken for granted that the reaction between nitrones (and possibly, other dipoles too) and dipolarophiles as simple 1,3-dipolar cycloaddition reactions. We have now established beyond reasonable doubt that a two step process is more likely in these cases. We have also demonstrated that alternative mechanisms can be suggested for the formation of products generated in such reactions. In the light of our novel findings, it would be worthwhile to revisit other 1,3-dipolar cycloaddition reactions reported in literature.

3.3.11. Conclusion

In the present study we illustrated that the presumed 1,3-dipolar cycloaddition reaction between nitrones and DBA in fact is a stepwise

1,3-dipolar addition reaction proceeding through a zwitterionic intermediate. Cyclisation of the zwitterionic intermediate to the formal cycloadduct is only one of the several possible pathways. Moreover we demonstrated that, the reaction between nitrones and DBA is an efficient method for the synthesis of pharmacologically as well as synthetically important 3(2*H*)-furanones and quinolines.

3.4. Experimental Section

3.4.1. General Techniques

All reactions were carried out in oven dried glassware. Solvents used for the experiments were distilled and dried by employing standard protocols. All starting materials were purchased either from *Sigma-Aldrich* or from *S. D. Fine Chemicals* and were used without further purification. The progress of the reactions was monitored with the help of thin layer chromatography using dried and activated silica gel TLC plates (Aluminum sheets coated with silica gel, *E. Merck*). The visualisation of TLC plates was done by exposure to iodine vapours or UV lamp. The separation and purification of compounds were done by column chromatography using silica gel (*S.D. Fine*, 60-120 mesh). Mixtures of ethyl acetate and hexane were used as the eluent. After the chromatographic separation, the solvent was removed using *Heidolph* rotary evaporator. The products were further purified by recrystallization from the appropriate solvent system. Melting points were recorded on Neolab melting point apparatus and are uncorrected. Elemental analysis was performed on Elementar Systeme (*Vario EL III*). FAB mass spectra were recorded on JEOL JMS 600. Infrared spectra were recorded on *ABB Bomem* (MB Series) FT-IR spectrometer. ¹H and ¹³C NMR spectra were recorded at 400 and 100 MHz on *Bruker* FT -NMR spectrometer using CDCl₃

as the solvent. The chemical shifts are given in δ scale with TMS as internal standard.

3.4.2. General Procedure for Cycloaddition

A mixture of nitronone (4 mmol) and dibenzoylacetylene (0.94 g, 4 mmol) in 25 mL of acetonitrile was stirred for about 4h at RT (20 min for diphenyl nitrones). The progress of the reaction was monitored by TLC. When the reaction was complete, products were isolated by column chromatography over silica gel using mixtures of hexane and ethyl acetate as eluents. The products were further purified by recrystallization from hexane:DCM mixture.

3.4.3. General Procedure for Hydrolysis of 1:1 Adducts

A mixture of oxalic acid (0.25 g, 2 mmol) and silica gel (2 g) in 20 mL of DCM was stirred for about 15 min. The solvent was evaporated off and about 2 mmol of 1:1 adduct in 30 mL of DCM was added to it and the mixture was stirred for about 1h. The progress of the reaction was monitored by TLC. When the reaction was complete, the products were isolated by column chromatography over silica gel using mixtures of hexane and DCM as eluents. The products were further purified by recrystallization from hexane:DCM mixture.

3.4.4. Spectral and Analytical Data of Novel Compounds

3.4.4.1. Compound 33a:

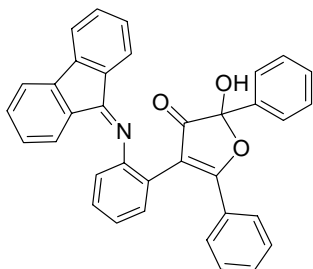

mp 206 °C;

IR ν_{\max} (KBr): 3280 (OH), 1676 cm^{-1} (C=O);

^1H NMR (CDCl_3): δ 6.56-7.72 (m, 22H), 4.97 (bs, 0.53H);

^{13}C NMR (CDCl_3): δ 198.72, 162.60, 143.39, 142.78, 137.18, 135.72, 132.17, 131.71, 130.77, 129.84, 129.01, 128.38, 128.25, 127.64, 127.01, 125.17, 124.45, 123.26, 119.84, 119.30, 118.55, 102.03;

FAB-MS: m/z calculated for $\text{C}_{35}\text{H}_{23}\text{NO}_3$: 505 (M^+); measured: m/z 506 (M^++1), 400, 105 and other peaks.

Elemental analysis calculated for $\text{C}_{35}\text{H}_{23}\text{NO}_3$: C, 83.15; H, 4.59; N, 2.77; O, 9.49%; found: C, 83.04; H, 4.82; N, 2.45%.

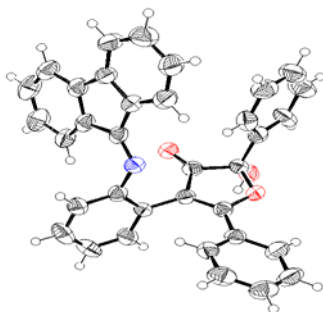

3.4.4.2. Compound 33b:

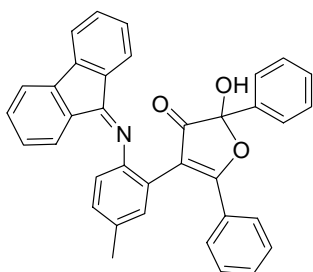

mp 210 °C;

IR ν_{\max} (KBr): 3263 (OH), 1681 cm^{-1} (C=O);

^1H NMR (CDCl_3): δ 6.72-7.74 (m, 21H), 4.26 (s, 0.42H), 2.44 (s, 3H);

^{13}C NMR (CDCl_3): δ 198.83, 162.58,

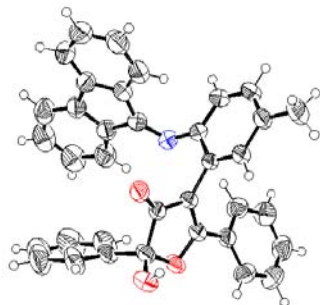

143.36, 137.31, 135.78, 133.93, 131.68, 129.75, 129.01, 128.33, 127.59, 127.04, 125.96, 125.22, 123.22, 119.80, 119.27, 118.52, 102.02, 21.02;

FAB-MS: m/z calculated for $C_{36}H_{25}NO_3$: 519 (M^+); measured: m/z 520 (M^++1), 414, 105 and other peaks.

Elemental analysis calcd for $C_{36}H_{25}NO_3$: C, 83.22; H, 4.85; N, 2.70; O, 9.24%; found: C, 83.28; H, 4.92; N, 2.68%.

3.4.4.3. Compound 33c:

mp 218 °C;

IR ν_{max} (KBr): 3274 (OH), 1698 cm^{-1} (C=O);

1H NMR ($CDCl_3$): δ 6.68-7.71 (m, 21H), 4.21 (bs, 0.68H);

^{13}C NMR ($CDCl_3$): δ 198.14, 163.52, 143.52, 141.91, 136.99, 135.51, 132.00, 131.48, 130.60, 129.63, 129.10, 128.36, 127.73, 126.96, 125.20, 123.39, 121.47, 120.01, 119.39, 102.33;

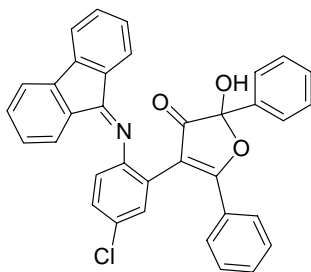

FAB-MS: m/z calculated for $C_{35}H_{22}ClNO_3$: 539 (M^+); measured: m/z 540 (M^++1), 541, 434, 105 and other peaks.

Elemental analysis calculated for $C_{35}H_{22}ClNO_3$: C, 77.85; H, 4.11; Cl, 6.57; N, 2.59; O, 8.89%; found: C, 77.15; H, 4.01; N, 2.63%.

3.4.4.4. Compound 34a:

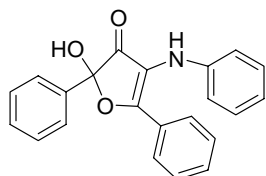

mp 150 °C;

IR ν_{\max} (KBr): 3354, 3297 (OH, NH),
1673 cm^{-1} (C=O);

^1H NMR (CDCl_3): δ 6.60-8.14 (m, 15H), 5.1
(s, 0.80H), 4.60 (bs, 0.68H);

^{13}C NMR (CDCl_3): δ 198.69, 176.34,
144.21, 135.76, 132.94, 129.72, 129.27,
128.81, 128.51, 125.75, 119.83, 115.14,
114.74, 101.14;

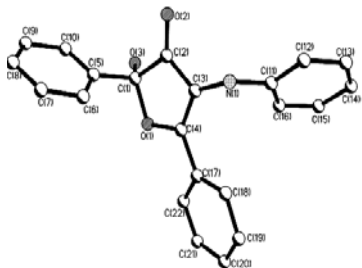

FAB-MS: m/z calculated for $\text{C}_{22}\text{H}_{17}\text{NO}_3$:
343 (M^+); measured: m/z 344 (M^++1), 238,
105 and other peaks.

Elemental analysis calculated for
 $\text{C}_{22}\text{H}_{17}\text{NO}_3$: C, 76.95; H, 4.99; N, 4.08; O,
13.98%; found: C, 76.82; H, 4.84; N, 4.14%.

3.4.4.5. Compound 34b:

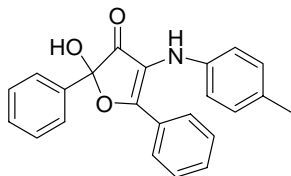

mp 154 °C;

IR ν_{\max} (KBr): 3360, 3301 (OH, NH),
1673 cm^{-1} (C=O);

^1H NMR (CDCl_3): δ 6.52-8.14 (m, 14H),
5.02 (s, 0.73H), 4.30 (bs, 0.60H),
2.21(s, 3H);

^{13}C NMR (CDCl_3): δ 199.13, 172.34,
141.86, 135.78, 132.87, 129.79, 129.63,
129.02, 128.79, 128.74, 128.56, 125.77,
115.60, 114.79, 114.41, 101.29, 20.45;

FAB-MS: m/z calculated for $\text{C}_{23}\text{H}_{19}\text{NO}_3$:

357 (M^+); measured: m/z 358 (M^++1), 252, 105 and other peaks.

Elemental analysis calcd for $C_{23}H_{19}NO_3$: C, 77.29; H, 5.36; N, 3.92; O, 13.43%; found: C, 77.14; H, 5.44; N, 3.86%.

3.4.4.6. Compound 34c:

mp 182 °C;

IR ν_{\max} (KBr): 3352, 3289 (OH, NH), 1670 cm^{-1} (C=O);

1H NMR ($CDCl_3$): δ 6.52-8.11 (m, 14H), 5.1 (s, 0.72H), 4.60 (bs, 0.68H);

^{13}C NMR ($CDCl_3$): δ 198.82, 174.36, 144.24, 135.62, 133.16, 129.85, 129.21, 128.94, 128.85, 128.43, 125.70, 115.86, 114.36, 101.11;

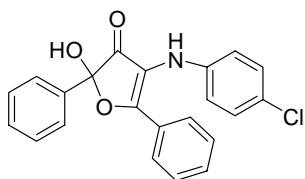

FAB-MS: m/z calculated for $C_{22}H_{16}ClNO_3$: 377 (M^+); measured: m/z 378 (M^++1) 379, 272, 105 and other peaks.

Elemental analysis calculated for $C_{22}H_{16}ClNO_3$: C, 69.94; H, 4.27; Cl, 9.38; N, 3.71; O, 12.70%; found: C, 69.82; H, 4.26; N, 3.78%.

3.4.4.7. Compound 40a:

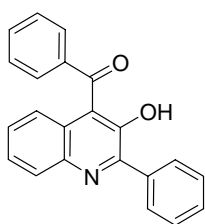

mp 142 °C;

IR ν_{\max} (KBr): 3448 (OH), 1667 cm^{-1} (C=O);

^1H NMR (CDCl_3): δ 9.19 (s, 0.89H), 7.27-8.15 (m, 14H);

^{13}C NMR (CDCl_3): δ 198.68, 151.78, 148.60, 143.09, 138.39, 136.64, 134.00, 130.13, 129.80, 129.52, 128.86, 128.63, 127.23, 126.97, 125.32, 124.89, 122.45;

FAB-MS: m/z calculated for $\text{C}_{22}\text{H}_{15}\text{NO}_2$: 325 (M^+); measured: m/z 326 (M^++1), 220, 105 and other peaks.

Elemental analysis calculated for $\text{C}_{22}\text{H}_{15}\text{NO}_2$: C, 81.21; H, 4.65; N, 4.30; O, 9.83%; found: C, 81.14; H, 4.62; N, 4.22%.

3.4.4.8. Compound 40b:

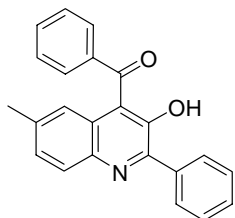

mp 133 °C;

IR ν_{\max} (KBr): 3436 (OH), 1672 cm^{-1} (C=O);

^1H NMR (CDCl_3): δ 8.81 (s, 0.55H), 7.10-7.98 (m, 13H), 2.29 (s, 3H);

^{13}C NMR (CDCl_3): δ 198.43, 150.51, 148.00, 141.73, 138.18, 137.38, 136.60,

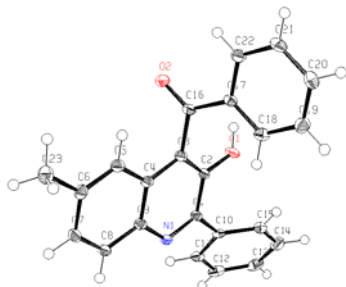

133.86, 129.69, 129.34, 129.20, 128.74, 128.59, 125.40, 123.83, 122.63, 21.75;

FAB-MS: m/z calculated for $C_{23}H_{17}NO_2$: 339 (M^+); measured: m/z 340 (M^++1), 234, 105 and other peaks.

Elemental analysis calculated for $C_{23}H_{17}NO_2$: C, 81.40; H, 5.05; N, 4.13; O, 9.43%; found: C, 51.82; H, 5.16; N, 4.21%.

3.4.4.9. Compound 40c:

mp 148 °C;

IR ν_{max} (KBr): 3451 (OH), 1668 cm^{-1} (C=O);

1H NMR ($CDCl_3$): δ 8.92 (0.72H), 7.34-8.15 (m, 13H);

^{13}C NMR ($CDCl_3$): δ 197.86, 151.87, 149.43, 140.92, 137.71, 135.66, 134.26, 133.44, 131.16, 129.81, 129.65, 129.42, 128.93, 128.60, 127.99, 125.99, 123.68, 121.90;

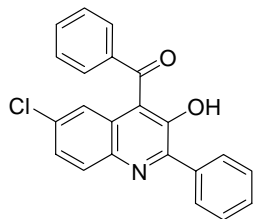

FAB-MS: m/z calculated for $C_{22}H_{14}ClNO_2$: 359 (M^+); measured: m/z 360 (M^++1), 361, 254, 105 and other peaks. Elemental analysis calculated for $C_{22}H_{14}ClNO_2$: C, 73.44; H, 3.92; Cl, 9.85; N, 3.89; O, 8.89%; found: C, 73.38; H, 4.02; N, 3.94%.

3.4.4.10. Compound 43a:

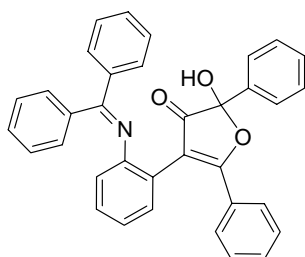

mp 142 °C;

IR ν_{\max} (KBr): 3282 (OH), 1672 cm^{-1} (C=O);

^1H NMR (CDCl_3): δ 7.12-7.74 (m, 24H), 4.68 (bs, 0.62H);

^{13}C NMR (CDCl_3): δ 198.58, 164.52, 144.18, 142.68, 137.38, 134.79, 132.29, 131.68, 130.09, 129.41, 128.13, 128.62, 127.52, 127.17, 125.34, 125.16, 123.24, 122.21, 120.03, 119.27, 101.64;

FAB-MS: m/z calculated for $\text{C}_{35}\text{H}_{25}\text{NO}_3$: 507 (M^+); measured: m/z 508 (M^++1) and other peaks.

Elemental analysis calculated for $\text{C}_{35}\text{H}_{25}\text{NO}_3$: C, 82.82; H, 4.96; N, 2.76; O, 9.46%; found: C, 82.67; H, 5.02; N, 2.72%.

3.4.4.11. Compound 43b:

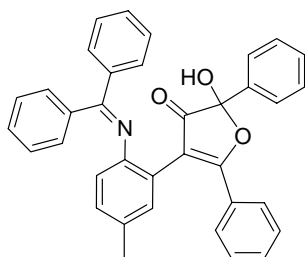

mp 134 °C;

IR ν_{\max} (KBr): 3278 (OH), 1684 cm^{-1} (C=O);

^1H NMR (CDCl_3): δ 7.08-7.68 (m, 23H), 4.34 (bs, 0.52H), 2.31(s, 3H);

^{13}C NMR (CDCl_3): δ 198.32, 167.02, 143.75, 142.64, 136.45, 135.62, 132.78, 132.39, 129.65, 129.44, 128.23, 126.58, 125.67, 125.37, 123.24, 120.22, 119.45,

101.82, 21.14;

FAB-MS: m/z calculated for $C_{36}H_{27}NO_3$: 521 (M^+); measured: m/z 522 (M^++1) and other peaks.

Elemental analysis calcd for $C_{36}H_{27}NO_3$: C, 82.90; H, 5.22; N, 2.69; O, 9.20%; found: C, 82.96; H, 5.18; N, 2.72%.

3.4.4.12. Compound 43c:

mp 150 °C;

IR ν_{max} (KBr): 3276 (OH), 1698 cm^{-1} (C=O);

1H NMR ($CDCl_3$): δ 7.02-7.78 (m, 23H), 4.52 (bs, 0.58H);

^{13}C NMR ($CDCl_3$): δ 197.68, 167.93, 143.92, 142.13, 136.82, 135.42, 131.81, 131.42, 130.79, 129.81, 129.27, 127.78, 126.16, 125.68, 124.69, 123.74, 121.82, 121.33, 119.46, 102.08;

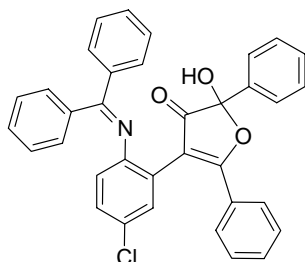

FAB-MS: m/z calculated for $C_{35}H_{24}ClNO_3$: 541 (M^+); measured: m/z 542 (M^++1), 543 and other peaks.

Elemental analysis calculated for $C_{35}H_{24}ClNO_3$: C, 77.56; H, 4.46; Cl, 6.54; N, 2.58; O, 8.86%; found: C, 77.62; H, 4.42; N, 2.64%.

3.4.4.13. Compound 46:

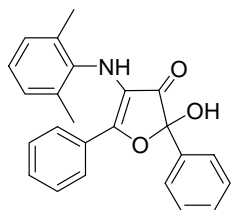

mp 220 °C;

IR ν_{max} (KBr): 3373, 3312 (OH, NH),
1665 cm^{-1} (C=O);

^1H NMR (CDCl_3): δ 9.1(s,1H), 6.82-8.86
(m, 14H), 2.32 (s, 3H), 2.02 (s, 3H).

3.5. References

1. Harju, K.; Yli-Kauhaluoma, J. *Recent Res. Devel. Organic Chem.* **2004**, *8*, 111.
2. Harju, K.; Vahermo, M.; Mutikainen, I.; Kauhaluoma, J. Y. *J. Comb. Chem.* **2003**, *5*, 826.
3. Padwa, A. In *1,3-Dipolar Cycloaddition Chemistry; Wiley Interscience: New York, 1984, Vol. 1 and 2.*
4. Lee, Y.; Koyama, Y.; Yonekawa, M.; Takata, T. *Macromolecules* **2009**, *42*, 7709.
5. Singh, I.; Zarafshani, Z.; Lutz, J. F.; Heaney, F. *Macromolecules* **2009**, *42*, 5411.
6. Wang, X.; Jiang, D.; Dai, S. *Chem. Mater.* **2008**, *20*, 4800.
7. Bakbak, S.; Leech, P. J.; Carson, B. E.; Saxena, S.; King, W. P.; Bunz, U.H. F. *Macromolecules* **2006**, *39*, 6793.
8. Collman, J. P.; Devaraj, N. K.; Chidsey, C. E. D. *Langmuir* **2004**, *20*, 1051.
9. Speers, A. E.; Adam, G. C.; Cravatt, B. F. *J. Am. Chem. Soc.* **2003**, *125*, 4686.
10. Amblard, F.; Cho, J. H.; Schinazi, R. F. *Chem. Rev.* **2009**, *109*, 4207.
11. Bayazit, M. K.; Coleman, K. S. *J. Am. Chem. Soc.* **2009**, *131*, 10670.

12. Gutmiedl, K.; Wirges, C. T.; Ehmke, V.; Carell, T. *Org. Lett.* **2009**, *11*, 2405.
13. Krasinski, A.; Radic, Z.; Manetsch, R.; Raushel, J.; Taylor, P.; Sharpless, K. B.; Kolb, H. C. *J. Am. Chem. Soc.* **2005**, *127*, 6686.
14. Seo, T. S.; Bai, X.; Ruparel, H.; Li, Z.; Turro, N. J.; Ju, J. *Proc. Natl. Acad. Sci.: USA*, **2004**, *101*, 5488.
15. Ju, J.; Seo, T. S.; Li, Z. *Tetrahedron Lett.* **2004**, *45*, 3143.
16. Rappai, J. P.; Raman, V.; Unnikrishnan, P. A.; Prathapan, S.; Thomas, S. K.; Paulose, C. S. *Bioorg. Med. Chem. Lett.* **2009**, *19*, 764.
17. Rappai, J. P.; Prathapan, S.; Vishnu Unni, M. V.; Unnikrishnan, P. A. *Synth. Commun.* **2007**, *37*, 569.
18. Jacob, A. M.; Thumpakkara, R. K.; Prathapan, S. Jose, B. *Tetrahedron* **2005**, *61*, 4601.
19. Vadakkan, J. J.; Raman, V.; Fernandez, N. B. Prathapan, S.; Jose, B. *New J. Chem.* **2003**, *27*, 239.
20. Padwa, A.; Pearson, W. H. In *Synthetic Applications of 1,3-Dipolar Cycloaddition Chemistry Towards Heterocycles and Natural Products*, John Wiley and sons Inc.: New York, **2002**.
21. Baldwin, J. E.; Qureshi, A. K.; Sklarz, B. *Chem. Commun.* **1968**, 373.
22. Baldwin, J. E.; Pudussery, R. G.; Qureshi, A. K.; Sklarz, B. *J. Am. Chem. Soc.* **1968**, *90*, 5325.
23. Winterfeldt, E.; Krohn, W.; Stracke, H. U. *Chem. Ber.* **1969**, *102*, 2346.

24. Schmidt, G.; Stracke, H. U.; Winterfeldt, E. *Chem. Ber.* **1970**, *103*, 3196.
25. Abou-Garbia, M. A.; Joullie, M. M. *Heterocycles* **1979**, *12*, 819.
26. Tsuge, O.; Watanabe, H.; Masuda, K.; Yousif, M. M. *J. Org. Chem.* **1979**, *44*, 4543.
27. Huisgen, R.; Mloston, G.; Langhals, E. *J. Am. Chem. Soc.* **1986**, *108*, 6401.
28. Huisgen, R.; Mloston, G.; Langhals, E. *J. Org. Chem.* **1986**, *51*, 4087.
29. Quast, H.; Regnat, D.; Peters, E. *Angew. Chem. Int. Ed. Engl.* **1990**, *29*, 695.
30. Nguyen, M. T.; Chandra, A. K.; Sakai, S.; Morokuma, K. *J. Org. Chem.* **1999**, *64*, 65.
31. Su, M. D.; Liao, H. Y.; Chung, W. S. *J. Org. Chem.* **1999**, *64*, 6710.
32. Valentin, C. D.; Freccero, M.; Gandolfi, R.; Rastelli, A. *J. Org. Chem.* **2000**, *65*, 612.
33. Nguyen, L. T.; Proft, F. D.; Chandra, A. K.; Uchimaru, T.; Nguyen, M. T.; Geerling, P. *J. Org. Chem.* **2001**, *66*, 6096.
34. Domingo, L. R.; Picher, M. F. *Tetrahedron* **2004**, *60*, 5053.
35. Kavitha, K.; Venuvalingam, P. *Int. J. Quantum Chem.* **2005**, *104*, 64.
36. Cantillo, D.; Avalos, M.; Babiano, R.; Cintas, P.; Jimenez, J. C.; Light, M. E.; Palacios, J. C. *Org. Lett.* **2008**, *10*, 1079.

37. Lutz, R. E.; Smithey, W. R. *J. Org. Chem.* **1951**, *16*, 51.
38. Ley, S. V.; Cox, L. R.; Meek, G. *Chem. Rev.* **1996**, *96*, 423.
39. Collins, I. J. *Chem. Soc., Perkin Trans. 1* **1998**, 1869.
40. Collins, I. J. *Chem. Soc., Perkin Trans. 1* **1999**, 1377.
41. Kupchan, S. M.; Eakin, M. A.; Thomas, A. M. *J. Med. Chem.* **1971**, *14*, 1147.
42. Shin, S. S.; Noh, M. S.; Byun, Y. J.; Choi, J. K.; Kim, J. Y.; Lim, K. M.; Ha, J. Y.; Kim, J. K.; Lee, C. H.; Chung, S. *Bioorg. Med. Chem. Lett.* **2001**, *11*, 165.
43. Shin, S. S.; Byun, Y.; Lim, K. M.; Choi, J. K.; Lee, K. W.; Moh, J. H.; Kim, J. K.; Jeong, Y. S.; Choi, Y. H.; Koh, H. J.; Park, Y. H.; Oh, Y. I.; Noh, M. S.; Chung, S. *J. Med. Chem.* **2004**, *47*, 792.
44. Consantino, M. G.; Losco, P.; Castellano, E. E. *J. Org. Chem.* **1989**, *54*, 681.
45. Huet, F.; Lechevallier, A.; Pellet, M.; Conia, J. M. *Synthesis* **1978**, 63.
46. Doube, D.; Blouin, M.; Brideau, C.; Chan, C.; Desmarais, C.; Ethier, D.; Falgueyret, J. P.; Friesen, R. W.; Girard, M.; Girard, Y.; Guay, J.; Tagari, P.; Young, R. N. *Bioorg. Med. Chem. Lett.* **1998**, *8*, 1255.
47. Kidwai, M.; Bhushan, K. R.; Sapra, P.; Saxena, R. K.; Gupta, R. *Bioorg. Med. Chem.* **2000**, *8*, 69.
48. Moissev, I. K.; Zemtsova, M. N.; Trakhtenberg, P. L.; Kulikowa, D. A.; Pskobkina, I.; Neshchadim, G. N.; Ostapchuk, N. V. *Khim. Farm. Zh.*

1998, 22, 1448.

49. Craig, J. C.; Person, P. E. *J. Med. Chem.* **1971**, 14, 1221.
50. Narsinh, D.; Anamik, S. *Ind. J. Pharm. Sci.* **2001**, 63, 211.
51. Dillard, R. D.; Pavey, D. E.; Benslay, D. N. *J. Med. Chem.* **1973**, 16, 251.
52. Montes, V. A.; Pohl, R.; Shinar, J.; Anzenbacher, P. Jr. *Chem. Eur. J.* **2006**, 12, 4523.
53. Glagovich, N.; Reed, E.; Crundwell, G.; Updegraff III, J. B.; Zeller, M.; Hunter, A. D. *Acta Cryst.* **2004**, E60, o623.

Chapter 4

SYNTHESIS AND 1,3-DIPOLAR CYCLOADDITION REACTIONS OF AZOMETHINE IMINES

4.1. Abstract

The present chapter describes the synthesis and 1,3-dipolar cycloaddition reactions of a few azomethine imines followed by chemical transformation of the cycloadducts formed.

4.2. Introduction

Azomethine imines, occasionally described as *N*-aminides,¹ are 1,3-dipoles belonging to the class of allyl anion type 1,3-dipoles (Scheme 4.1).²

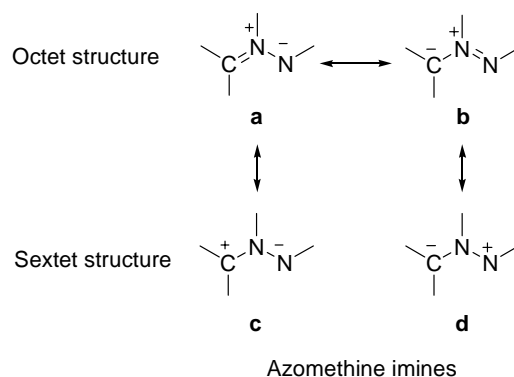

Scheme 4.1

In Scheme 4.1, **a** and **b** represent octet stabilized structures whereas **c** and **d** represent the sextet stabilized structures. Canonical form **a** is expected to be more important as a result of the higher electronegativity of nitrogen compared to carbon.

2-Methylindazole, which was prepared by Schad in 1893 can be considered as the first azomethine imine prepared, even though he had not recognized it as a 1,3-dipole.³ While studying the reactions of 2-methylindazole with maleic anhydride Huisgen proposed following azomethine imine structure (Scheme 4.2).⁴

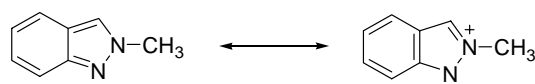

Scheme 4.2

Another azomethine imine equivalent is sydnones. Sydnones are generally synthesized by the cyclisation of *N*-nitroso- α -amino acids. Huisgen *et al.* have demonstrated that the mesoionic form of sydnones reacts with dipolarophiles followed by the elimination of CO₂, thus behaving like an azomethine imine (Scheme 4.3).⁵

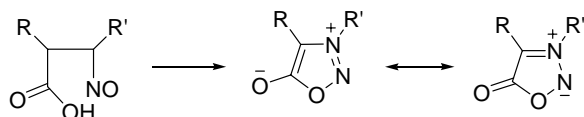

Scheme 4.3

Several methods are available for the generation of azomethine imines. In most of the methods azomethine imines are generated *in situ*. Condensation of 1,2-disubstituted hydrazines with aldehydes, acetals, or hemiacetals is a commonly employed method for the *in situ* generation of azomethine imines.⁶ Azomethine imines can also be generated from hydrazones by thermal⁷ or acid induced⁸ 1,2-prototropy from the terminal

nitrogen atom to the central nitrogen atom. In addition to these methods, electrochemical oxidation of hydrazine derivatives in presence of lithium perchlorate followed by deprotonation of resulting diazenium salts,⁹ reaction of azo compounds with ketenes or carbonyl ylides,¹⁰ condensation of α -ketoesters with monosubstituted hydrazines,¹¹ *etc.* are also useful for *in situ* generation of azomethine imines. A relatively stable, but reactive, azomethine imine was prepared by Huisgen *et al.* by treating electrophilic aryl diazocyanides with nucleophilic diaryldiazoalkanes. (Scheme 4.4).¹²

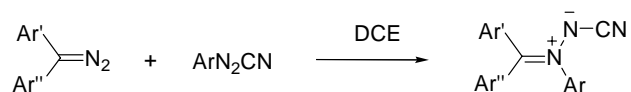

Scheme 4.4

Since N^{β} -cyanoazomethine imine incorporates a 1,3-dipolar system as well as a dipolarophilic cyano group, there is every chance for the molecule to undergo intramolecular cycloaddition. It was found that N^{β} -cyanoazomethine imine derived from diphenyldiazomethane undergoes trimerisation at higher temperatures. According to Huisgen, the trimerisation consists of a sequence of three 1,3-dipolar cycloadditions of which the concluding one takes place intramolecularly (Scheme 4.5).¹³ In order to get the β -cyanoazomethine imine in better yields we did the synthesis at a lower temperature (0-5 °C).

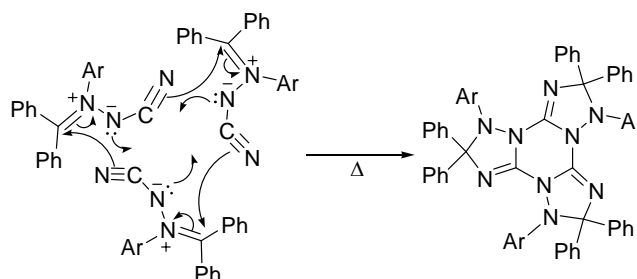

Scheme 4.5

Azomethine imines are involved in a wide range of synthetically useful reactions in the field of heterocyclic chemistry. For example, they can react with alkenes and alkynes to give the corresponding pyrazolidines and pyrazolines respectively.¹⁴ Pyrazolines have been widely used in material chemistry for their role as optical brightening agents for textiles, paper, and fabrics because of their strong fluorescence,¹⁵ as light emitter in blue organic electroluminescence devices,^{16,17} and as a hole-conveying medium in photoconductive materials,¹⁸ and electroluminescence devices.¹⁹ Pyrazolines and their derivatives also play an important role in pharmaceutical field. For e.g., pyrazolines have been reported to exhibit a wide range of biological activities, including antidepressant,²⁰ antitumor,²¹ antibacterial,²² and antifungal activities.²³

In the previous chapter, we presented compelling evidence to show that the reaction between nitrones and DBA is a stepwise reaction. In addition to this, we found that the course of the reaction is controlled by the steric barrier offered by the substituents on the α -C of nitrone. Because of the high nucleophilicity of nitrones, the first step of the reaction *i.e.*, the formation of zwitterionic intermediate may be fast compared to the cyclisation step which is controlled by the substituents on the α -C of nitrone. This enhanced life time will give a chance for the zwitterionic intermediate to undergo other sorts of reactions. In order to verify this argument we chose the 1,3-dipolar cycloaddition reaction between N^β -cyanoazomethine imines, a less nucleophilic dipole, with identical steric environments and the same acetylenic compound *viz* DBA.

4.3. Results and Discussion

The azomethine imines selected for our present study are given in Figure 4.1. The steric hindrance offered by the α -C of azomethine imines

1a-c and **2a-c** are supposed to be the same as that of nitrones **27a-c** and **28a-c** presented in the third chapter. The constraint we changed here is the nucleophilicity of the dipole. The presence of $-\text{CN}$ group is one of the reasons for the low nucleophilicity of the selected azomethine imines.

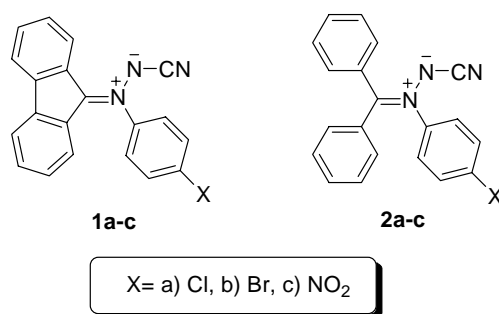
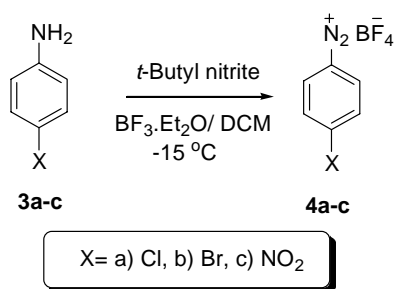

Figure 4.1

4.3.1 Synthesis of N^α -Fluorenylidene- N^α -aryl- N^β -cyanoazomethine Imines

The required azomethine imines were prepared from corresponding diaryldiazoalkanes and arene diazocyanides.¹² The diaryldiazoalkanes were prepared by the procedure given in Chapter 2. The arene diazocyanides required for the synthesis of azomethine imines were synthesized by a procedure developed by Ahern *et al.* from the corresponding arenediazonium tetrafluoroborate salts *via* the phase-transfer synthesis mediated by crown ether, 18-crown-6.²⁴

The arenediazonium tetrafluoroborate salts **4a-c** were prepared by diazotisation of corresponding *para*-substituted anilines **3a-c** with slight excess of *t*-butyl nitrite and boron trifluoride etherate at $-15\text{ }^\circ\text{C}$. (scheme **4.6**).²⁴ The products were identified by comparing their spectral and analytical data with those reported in the literature.²⁵



Scheme 4.6

The arene diazocyanides **5a-c** required for the synthesis of azomethine imines were readily prepared *via* phase-transfer synthesis developed by Ahern *et al.* in 1982.²⁶ Reaction between the corresponding arenediazonium tetrafluoroborate salts **4a-c** with one equivalent of potassium cyanide in presence of 5 mol % 18-crown-6 gave the required arene diazocyanides **5a-c** in good yields (scheme **4.7**). The products **5a-c** were identified on the basis of their spectral and analytical data²⁶

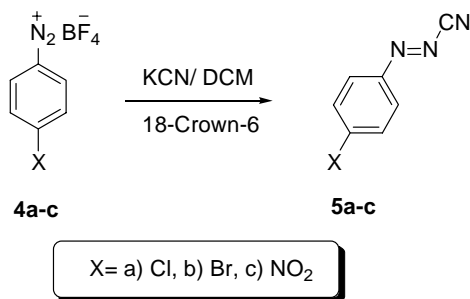

Scheme 4.7

The use of the crown ether greatly reduced the quantity of highly poisonous KCN required for the synthesis as well as time taken for the reaction compared to conventional procedure.²⁸ Since BF₄⁻ is a softer anion than CN⁻, the crown-complexed K⁺ ion will preferentially pair with BF₄⁻. The net result is the removal of crown ether by complexation, thereby retarding

further addition of CN^- as observed when quaternary ammonium salts are used as phase transfer catalyst (scheme 4.8). That is, the success of the method is partially because of the fortuitous moderating effect of the byproduct, KBF_4 , on crown catalyst.²⁴

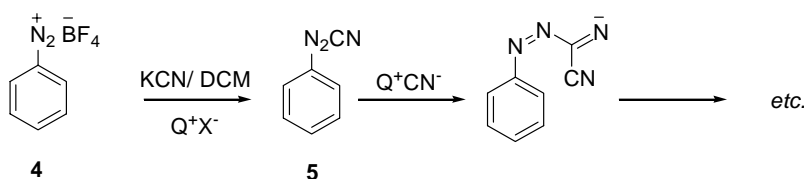

Scheme 4.8

The azomethine imines were prepared from the corresponding arene diazocyanides by stirring with diaryldiazoalkanes in DCE. Electrophilic attack of arene diazocyanides **5a-c** on 9-diazo fluorene (**6**) produced the corresponding N^β -cyanoazomethine imines *viz.* N^α -fluorenylidene- N^α -aryl- N^β -cyanoazomethine imines **1a-c** in high yields with the elimination of nitrogen (Scheme 4.9). The products were filtered, washed with DCE, and dried. The reaction was done at a lower temperature ($<20^\circ\text{C}$) to eliminate the possibility for the formation of trimer as seen in Scheme 4.5. These azomethine imines are fairly stable. The fluorenyl residue and nitrile group provide a good stabilization for the positive and negative charges respectively. This was supported with dipole moment measurements. For *e.g.*, the measured dipole moment value of N^α -fluorenylidene- N^α -(4-bromophenyl)- N^β -cyanoazomethine imine **1b** in dioxan at 25°C is about 6.62 D. A comparison of the spectral and analytical data given in the literature confirmed the identity of the products.¹²

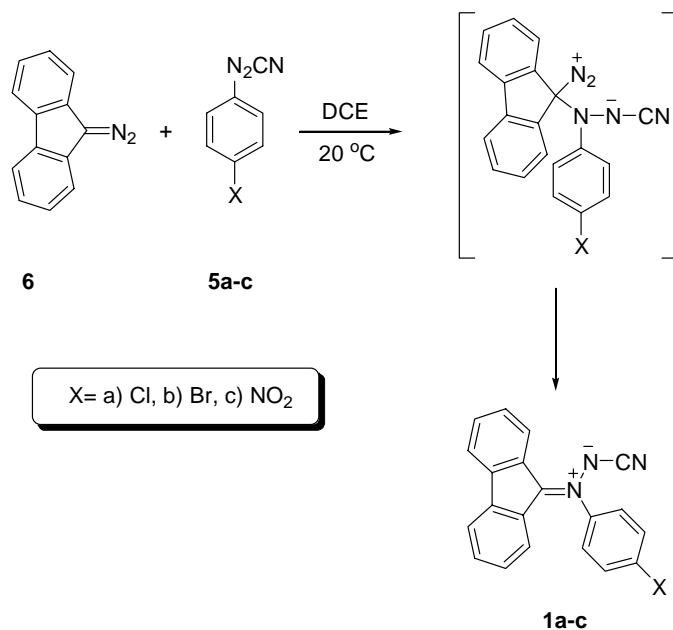

Scheme 4.9

4.3.2. Synthesis of N^α -Diphenylmethylene- N^α -aryl- N^β -cyanoazomethine Imines

When diphenyldiazomethane (**7**) was used instead of 9-diazafluorene in the above reaction, corresponding N^α -diphenylmethylene- N^α -aryl- N^β -cyanoazomethine imines **2a-c** were generated quantitatively (scheme **4.10**). The use of dry acetone as solvent and a reaction temperature of ~ 0 -5 °C were found to improve the yield and purity of the product. The products were filtered, washed with acetone, and dried. Identity of the products was confirmed by comparing their spectral and analytical data with those reported in literature.¹²

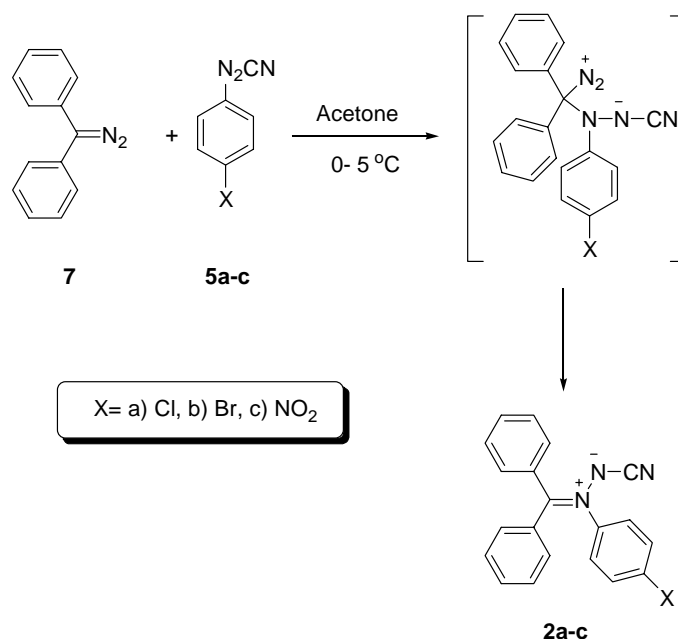

Scheme 4.10

Dibenzoylacetylene was prepared by the procedure described in the previous chapter. Dimethyl acetylenedicarboxylate was purchased from *Sigma Aldrich* and used as such.

4.3.3. 1,3-Dipolar Cycloaddition Reactions of N^α -Fluorenylidene- N^α -aryl- N^β -cyanoazomethine Imines with DBA

1,3-Dipolar cycloaddition reaction of N^α -fluorenylidene- N^α -aryl- N^β -cyanoazomethine imine **1a-c** with dibenzoylacetylene (**8**) was conducted at RT in acetonitrile. The yellow precipitate formed was filtered and dried. While following the progress of the reaction by TLC analysis, to our surprise, we observed that spot corresponding to the product was highly fluorescent whereas the compound isolated by precipitation was not fluorescent. So we repeated the TLC experiment with the isolated product and got the same observation. Then we reasoned that the compound undergoes some sort of transformations on the surface of silica gel. To verify this possibility, we

passed compounds **9a-c** (non-fluorescent) through a silica column using 1:10::DCM:hexane as the eluent. The products **10a-c** recovered were found to be fluorescent. The preliminary information from the IR spectra shows that $-C\equiv N$ group is lost from the molecule. Since facile decyanation occurred on silica column, compounds **9a-c** were purified by recrystallization from DCM/hexane. On the basis of spectral and analytical data we identified compounds **9a-c** as 3-pyrazolins containing $-C\equiv N$ group and compounds **10a-c** as 2-pyrazolins without $-C\equiv N$ group (Scheme 4.11).

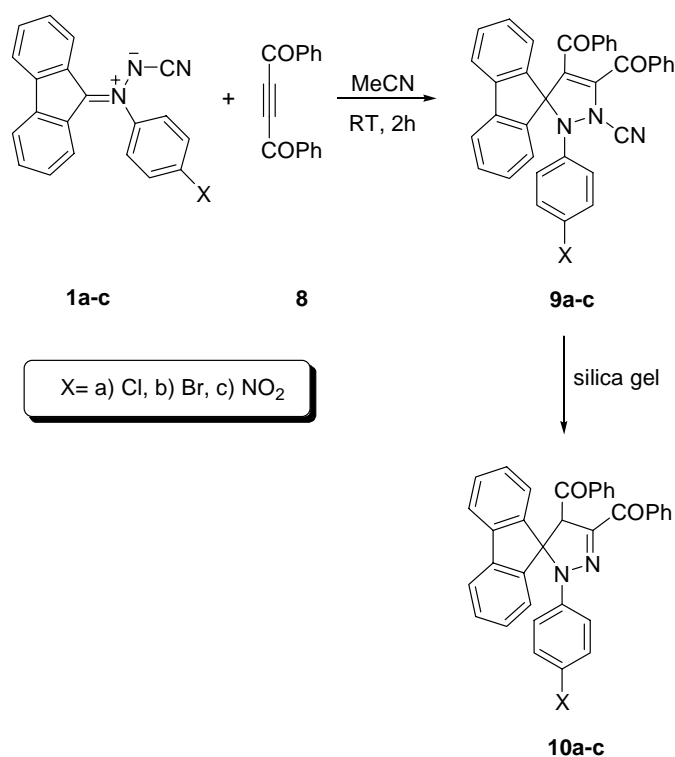

Scheme 4.11

In the IR spectrum of **9a**, the strong peak at 2221 cm^{-1} corresponds to the $-C\equiv N$ stretching vibration (the corresponding $-C\equiv N$ stretching frequency for azomethine imine is at 2118 cm^{-1}). Peaks at 1661 and 1649 cm^{-1} are due to

the C=O stretching of the two carbonyl groups in the dibenzoyl alkene component. The peak at 1610 cm^{-1} may be due to the C=C which is in conjugation with the -COPh. There is no peak corresponding to $>\text{C}=\text{N}<$ at $\sim 1548\text{ cm}^{-1}$. The aromatic protons appeared as multiplet from δ 6.70-7.60 in the ^1H NMR spectrum. In the ^{13}C NMR spectrum of **9a**, signals at δ 187.33 and δ 184.46 represents the carbonyl carbons. The peaks at δ 109.47 and 96.07 correspond to nitrile carbon ($\text{C}\equiv\text{N}$) and spiro carbon respectively. In the FAB mass spectrum, the molecular ion peak appears at m/z 564 (M^+). The peaks at m/z 458 and the base peak at 105 represent $[M^+ - \text{COPh}]$ and $[\text{COPh}]$ respectively. Figures 4.2 and 4.3 represent ^1H NMR and ^{13}C NMR of **9a**.

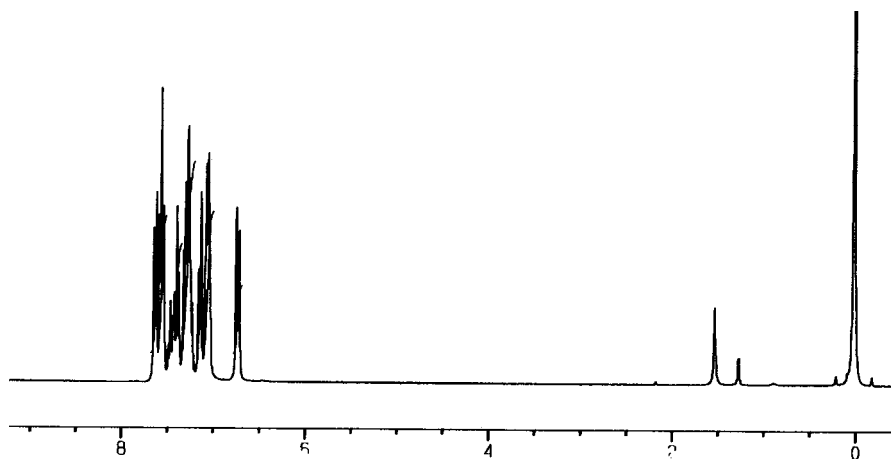

Figure 4.2 ^1H NMR spectra of **9a**

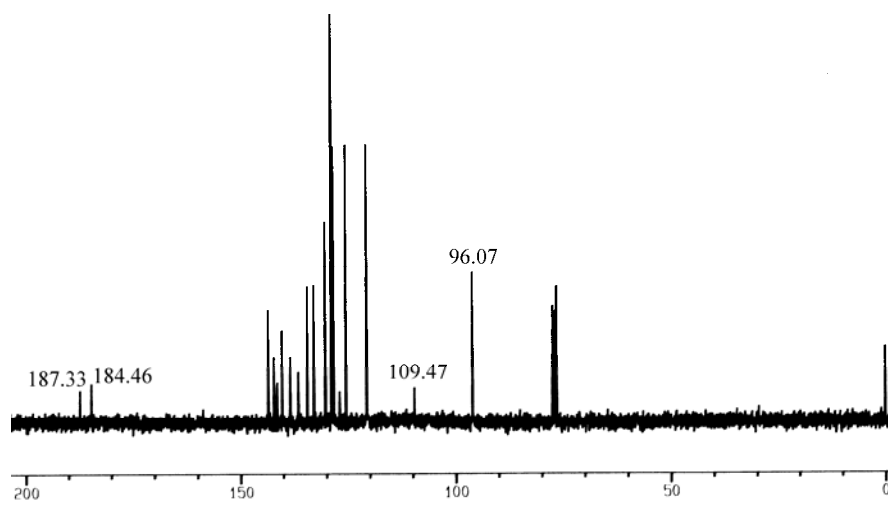

Figure 4.3 ^{13}C NMR spectra of **9a**

Compounds **9b,c** exhibited spectral characteristics similar to those exhibited by **9a**. Based on this and analytical data, we identified the structures of 2-pyrazolines **9b,c**.

Next we turned our attention to identify the structure of decyanation products **10a-c**. In the IR spectrum of compound **10a**, there are no peaks corresponding to $\text{C}\equiv\text{N}$ and N-H stretching vibrations. The peaks at 1684 cm^{-1} (the C=O stretching frequency of acetophenone is about 1692 cm^{-1}) and 1649 cm^{-1} are due to C=O stretching of the two carbonyl groups. The strong peak at 1545 cm^{-1} may be the C=N stretching frequency. In the ^1H NMR spectrum, the peak at $\delta 5.80$ (s, 1H) is due to the hydrogen of the $>\text{C(H)-}$ group present in the pyrazoline ring system. Aromatic protons appeared as multiplet from $\delta 6.59$ to $\delta 8.40$. In the ^{13}C NMR spectrum of **10a**, the signals at $\delta 193.30$ and $\delta 185.95$ represent the carbonyl carbon. The peak at $\delta 147.05$ may be due to the imine carbon. The spiro carbon appeared at $\delta 96.19$ and the carbon of $>\text{C(H)-}$ group present in the pyrazoline ring system at $\delta 63.94$. In the FAB mass spectrum, the molecular ion peak appeared at m/z 539 (M^++1). The

peaks at m/z 433 and the base peak at 105 represent $[M^+ - \text{COPh}]$ and $[\text{COPh}]$ respectively. Figures 4.4 and 4.5 represent ^1H NMR and ^{13}C NMR of **10a**.

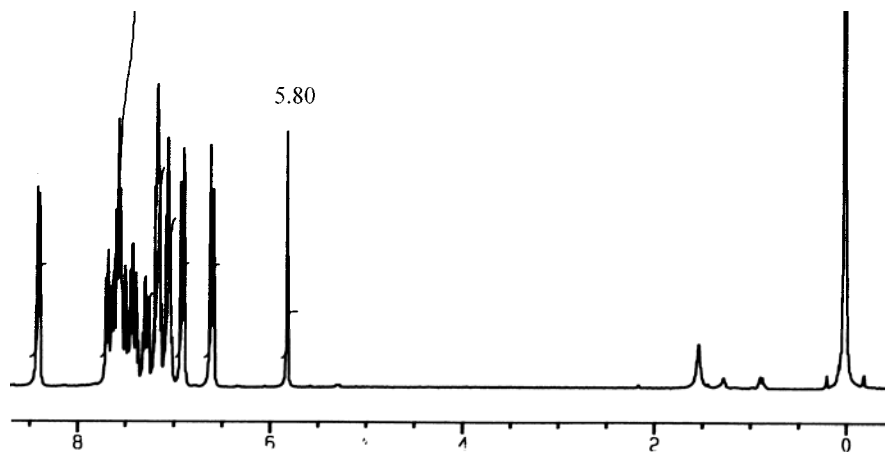

Figure 4.4 ^1H NMR spectra of **10a**

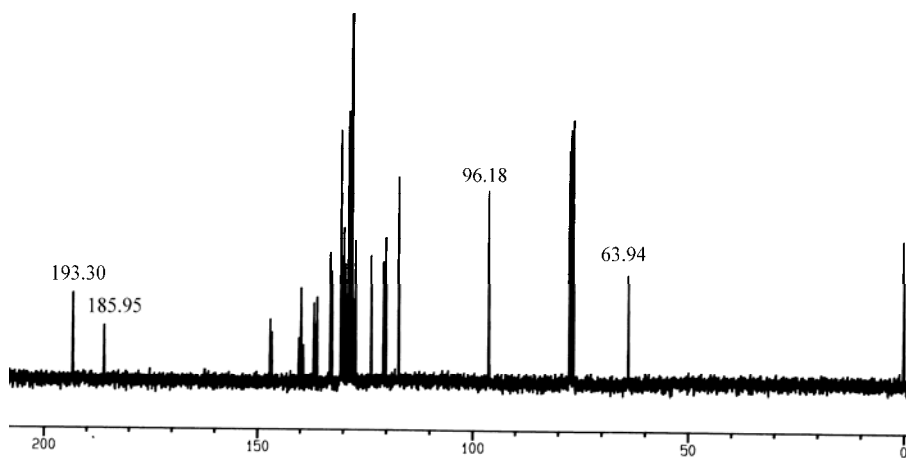
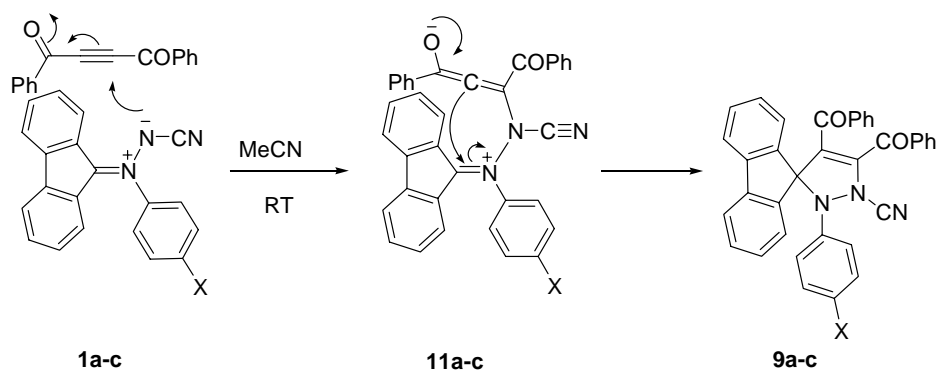

Figure 4.5 ^{13}C NMR spectra of **10a**

Compounds **10b,c** exhibited spectral characteristics similar to those of **10a**. Based on this and analytical data, we identified the structure of 2-pyrazolines **10b,c**.

4.3.4 Proposed Mechanism for the 1,3-Dipolar Cycloaddition Reactions of Azomethine Imines with DBA

On the basis of the results obtained from the nitron-DBA cycloaddition, low nucleophilicity of the selected azomethine imines compared to the corresponding nitrones and the stability of pyrazolines *vis-à-vis* the corresponding isoxazolines, we reasoned that the plausible mechanism for the reaction involves a slow Michael-type addition of azomethine imine to the acetylenic triple bond followed by a fast ring closure of the zwitterionic intermediate **11a-c** to the corresponding 3-pyrazoline **9a-c** (Scheme 4.12). In the case of **11a-c**, [3,3]-sigmatropic shift is not competitive with the cyclisation path leading to relatively stable 3-pyrazoline derivatives.



Scheme 4.12

4.3.5 1,3-Dipolar Cycloaddition Reactions of *N*^α-Diphenylmethylene-*N*^α-aryl-*N*^β-cyanoazomethine Imines with DBA

Similar to the reaction between *N*^α-fluorenylidene-*N*^α-aryl-*N*^β-cyanoazomethine imines and dibenzoylacetylene, the reaction between *N*^α-diphenylmethylene-*N*^α-aryl-*N*^β-cyanoazomethine imines **2a-c** and DBA resulted in the formation of 3-pyrazolins **12a-c**. They undergo decyanation on

the surface of silica gel to the corresponding 2-pyrazolins **13a-c** (Scheme 4.13).

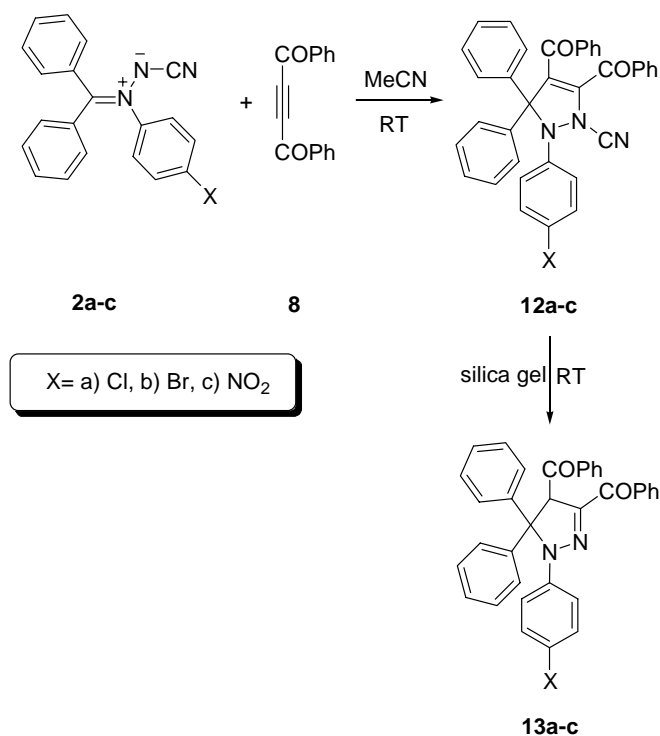

Scheme 4.13

The IR spectrum of compound **12a** shows a strong peak at 2224 cm⁻¹ corresponding to C≡N stretching vibration. The peaks at 1666 cm⁻¹ and 1640 cm⁻¹ may be due to the C=O stretching of the two carbonyl groups in the dibenzoyl alkene component. The peak at 1595 cm⁻¹ may be due to the C=C in conjugation with -COPh. The aromatic protons appeared as multiplet from δ 6.85 to δ 7.46. In the ¹³C NMR spectrum of **12a**, the signals at δ 186.54 and 184.32 represent the carbonyl carbons. The peaks at δ 107.98 and 96.07 correspond to nitrile carbon (C≡N) and tetrahedral carbon respectively. In the FAB mass spectrum, the molecular ion peak appeared at *m/z* 566 (*M*⁺+1) and the base peak at *m/z* 105.

Compounds **12b,c** exhibited spectral characteristics similar to those of **12a**. Based on this and analytical data, we identified the structure of 3-pyrazolines **12b,c**.

In the IR spectrum of **13a**, there are no peaks corresponding to the C≡N and N–H stretching vibrations. The peaks at 1687 cm⁻¹ and 1648 cm⁻¹ are due to the C=O stretching of the two carbonyl groups. The peak at 1542 cm⁻¹ may be due to the C=N stretching. In the ¹H NMR spectrum, the peak at δ 5.22 (s, 1H) is due to the hydrogen of the >C(H)– group present in the pyrazoline ring system. The aromatic protons appeared as multiplet from δ 6.80 to δ 7.68. In the ¹³C NMR spectrum of **13a**, the signals at δ 192.30 and δ 183.90 represent the carbonyl carbon. The tetrahedral carbon appeared at δ 96.09 and the carbon of >C(H)– group present in the pyrazoline ring system at δ 64.02. In the FAB mass spectrum, the molecular ion peak appeared at *m/z* 541 (*M*⁺+1) and the base peak at 105.

Compounds **13b,c** exhibited spectral characteristics similar to those of **13a**. Based on this and analytical data, we identified the structure of 2-pyrazolines **13b,c**.

Highly fluorescent molecules are of considerable interest. Serendipitously, we encountered a highly fluorescent molecule such as **10**. Close examination of the structural features of **10** revealed the presence of the highly fluorescent pyrazoline fluorophore. It also contains two benzoyl groups that can diminish fluorescence by promoting intersystem crossing. We reasoned that pyrazolines without benzoyl group would exhibit even higher fluorescence intensity. We thought of preparing pyrazoline targets by modifying the procedure developed for **10**. In principle, this can be achieved by reacting azomethine imines with other acetylene derivatives such as dimethyl acetylenedicarboxylate followed by decyanation under suitable condition.

Details of the reaction between azomethine imines and dimethyl acetylenedicarboxylate and attempted decyanation reaction are presented hereunder.

4.3.6 1,3-Dipolar Cycloaddition reaction of N^α -Fluorenylidene- N^α -(4-chlorophenyl)- N^β -cyanoazomethine Imine with DMAD

The reaction between N^α -fluorenylidene- N^α -(4-chlorophenyl)- N^β -cyanoazomethine imine **1a** with DMAD (**14**) leads to the formation of corresponding 3-pyrazoline **15** (Scheme 4.14).

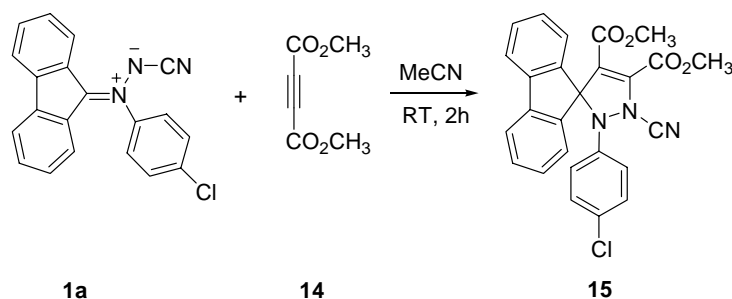

Scheme 4.14

In the IR spectrum of compound **15**, the peak at 2225 cm^{-1} is due to the stretching vibration of $\text{C}\equiv\text{N}$. The peaks 1736 cm^{-1} and 1743 cm^{-1} are due to the $\text{C}=\text{O}$ stretching of the carbonyl groups in the α,β -unsaturated ester component. In the ^1H NMR of compound **15**, the two singlets at δ 3.35 and δ 4.04 represent the hydrogens in the two methylcarboxylate groups. The aromatic protons appear at δ 6.54 -7.59. In ^{13}C NMR spectrum, the signals at δ 160.12 and δ 157.66 represent carbonyl carbons of the two ester groups. The peaks at δ 109.42 and δ 96.15 represent nitrile carbon ($\text{C}\equiv\text{N}$) and spiro carbon respectively. In the mass spectrum, molecular ion peak appears at m/z 472 (M^++1).

3-Pyrazoline **15** was treated with silica gel as well as oxalic acid adsorbed on silica gel and found to be unreactive (Scheme 4.15). There are reports that, it can undergo decyanation under strongly acidic conditions.²⁷

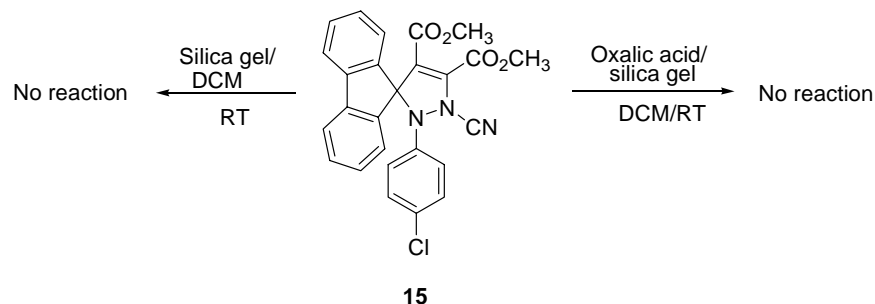

Scheme 4.15

4.3.7 Conclusion

In the formative years of azomethine imine chemistry, Huisgen had proposed a cascade of 1,3-dipolar addition reactions leading to trimerization of certain azomethine imines. This is an intermolecular reaction involving three tandem cycloadditions. Kinetically, such processes should be unfavorable. Furthermore, we have observed that azomethine imines are stable in acetonitrile solution indicating that a fast cycloaddition step between nitrile dipolarophile and azomethine imine dipole is not a general reaction. So, alternative mechanisms are possible for the observed trimerization reaction of azomethine imines. We argue that a nucleophilic addition type mechanism cannot be ruled out in this case. Based on our findings on the reaction between nitrones and DBA, we propose that reaction between azomethine imines and acetylenes may also proceed through a zwitterionic intermediate. The lower nucleophilicity of azomethine imine compared to nitrones may reduce the rate of formation of zwitterionic intermediate in the case of azomethine imine addition. Higher stability of pyrazolines compared to isoxazolines makes cyclisation favorable for the zwitterionic intermediate.

Hence the favoured reaction of zwitterionic intermediate is rapid cyclisation leading to the generation of pyrazolines with minimal interference from [3,3]-sigmatropic shift as observed in the case of nitrene addition to DBA.

In short, in the reaction between azomethine imines and DBA, a two step 1,3-dipolar addition sequence resulting in net *cyclization* is more probable than the commonly accepted 1,3-dipolar *cycloaddition* mechanism for the generation of pyrazolines. At the same time, we accept our failure in observing direct evidence for a two step process in this case and hence our arguments border the tenuous realm.

4.4. Experimental Section

4.4.1. General Techniques

All reactions were carried out in oven dried glassware. Solvents used for the experiments were distilled and dried by employing standard protocols. All starting materials were purchased either from *Sigma-Aldrich* or from *S. D. Fine Chemicals* and were used without further purification. The progress of the reactions was monitored with the help of thin layer chromatography using dried and activated silica gel TLC plates (Aluminium sheets coated with silica gel, *E. Merck*). The visualisation of TLC plates was done by exposure to iodine vapours or UV lamp. The separation and purification of compounds were done by column chromatography using silica gel (*S.D. Fine*, 60-120 mesh). Mixtures of ethyl acetate and hexane or DCM hexane were used as eluents. After the chromatographic separation, the solvent was removed using *Heidolph* rotary evaporator. The products were further purified by recrystallization from the appropriate solvent system. Melting points were recorded on *Neolab* melting point apparatus and are uncorrected. Elemental analysis was performed on *Elementar Systeme* (Vario EL III). FAB mass spectra were recorded on JEOL JMS 600. Infrared spectra

were recorded on *ABB Bomem* (MB Series) FT-IR spectrometer. ^1H and ^{13}C NMR spectra were recorded at 400 and 100 MHz on *Bruker* FT-NMR spectrometer using CDCl_3 as the solvent. The chemical shifts are given in δ scale with TMS as internal standard.

4.4.2. 4-Chlorobenzenediazonium tetrafluoroborate salt (4a):

4-Chlorobenzenediazonium tetrafluoroborate salt was prepared by a known procedure (88%, mp 136 °C).^{24,25}

4.4.3. 4-Bromobenzenediazonium tetrafluoroborate salt (4b):

4-Bromobenzenediazonium tetrafluoroborate salt was prepared by a known procedure (85%, mp 138 °C).^{24,25}

4.4.4. 4-Nitrobenzenediazonium tetrafluoroborate salt (4c):

4-Nitrobenzenediazonium tetrafluoroborate salt was prepared by a known procedure (82%, mp 157 °C).^{24,25}

4.4.5. (*E*)-4-Chlorobenzene diazocyanide (5a):

(*E*)-4-Chlorobenzene diazocyanide was prepared by a known procedure (90%, mp 102 °C).²⁶

4.4.6. (*E*)-4-Bromobenzene diazocyanide (5b):

(*E*)-4-Bromobenzene diazocyanide was prepared by a known procedure (80%, mp 128 °C).²⁶

4.4.7. (*E*)-4-Nitrobenzene diazocyanide (5c):

(*E*)-4-Nitrobenzene diazocyanide was prepared by a known procedure (84%, mp 82 °C).²⁶

4.4.8. N^α -Fluorenylidene- N^α -(4-chlorophenyl)- N^β -cyanoazomethine imine (1a):

N^α -Fluorenylidene- N^α -(4-chlorophenyl)- N^β -cyanoazomethine imine was prepared by a known procedure (88%, mp 190 °C).¹²

4.4.9. N^α -Fluorenylidene- N^α -(4-bromophenyl)- N^β -cyanoazomethine imine (1b):

N^α -Fluorenylidene- N^α -(4-bromophenyl)- N^β -cyanoazomethine imine was prepared by a known procedure (89%, mp 194 °C).¹²

4.4.10. N^α -Fluorenylidene- N^α -(4-nitrophenyl)- N^β -cyanoazomethine imine (1c):

N^α -Fluorenylidene- N^α -(4-nitrophenyl)- N^β -cyanoazomethine imine was prepared by a known procedure (80%, mp 210 °C).¹²

4.4.11. N^α -Diphenylmethylene- N^α -(4-chlorophenyl)- N^β -cyanoazomethine imine (2a):

N^α -Diphenylmethylene- N^α -(4-chlorophenyl)- N^β -cyanoazomethine imine was prepared by a known procedure (82%, mp 130 °C).¹²

4.4.12. N^α -Diphenylmethylene- N^α -(4-bromophenyl)- N^β -cyanoazomethine imine (2b):

N^α -Diphenylmethylene- N^α -(4-bromophenyl)- N^β -cyanoazomethine imine was prepared by a known procedure (83%, mp 128 °C).¹²

4.4.13. N^α -Diphenylmethylene- N^α -(4-nitrophenyl)- N^β -cyanoazomethine imine (2c):

N^α -Diphenylmethylene- N^α -(4-nitrophenyl)- N^β -cyanoazomethine imine was prepared by a known procedure (80%, mp 122 °C).¹²

4.4.14. Synthesis of Compound 9a:

A mixture of N^α -fluorenylidene- N^α -(4-chlorophenyl)- N^β -cyanoazomethine imine (1.32 g, 4 mmol) and dibenzoylacetylene (0.94 g, 4 mmol) in 25 mL of acetonitrile was stirred for about 2h at RT. The progress of the reaction was monitored by TLC. After the reaction was complete, the reaction mixture was cooled, and the yellow precipitate formed was filtered out. It was washed with a little acetonitrile, and dried to get 1-(4-chlorophenyl)-2-cyano-3,4-dibenzoyl-5-(2,2'-biphenyl)-2,5-dihydro-1H-pyrazole (**9a**).

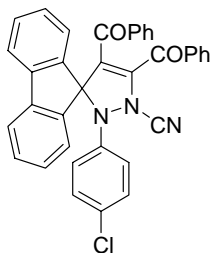

Yield 1.85 g, 82%; mp 172 °C

IR(KBr) ν_{\max} : 2221 (C≡N), 1661 and 1649 (C=O), 1610 cm^{-1} (C=C in conjugation with -COPh);

$^1\text{H NMR}$ (CDCl_3): δ 6.70-7.60 (m, 22H);

$^{13}\text{C NMR}$ (CDCl_3): δ 187.33, 184.46, 143.43, 142.13, 141.36, 140.14, 138.28, 136.39, 134.31, 132.82, 130.07, 128.79, 128.69, 128.20, 128.16, 128.10, 127.04, 125.48, 120.58, 120.45, 109.47, 96.07;

FAB-MS: m/z calculated for $\text{C}_{36}\text{H}_{22}\text{ClN}_3\text{O}_2$: 563 (M^+); measured: m/z 564 (M^++1).

Elemental analysis calculated for

$C_{36}H_{22}ClN_3O_2$: C, 76.66; H, 3.93; Cl, 6.29; N, 7.45; O, 5.67%; found: C, 76.55; H, 3.97; N, 7.48%.

4.4.15. Synthesis of Compound 9b:

A mixture of N^α -fluorenylidene- N^α -(4-bromophenyl)- N^β -cyanoazomethine imine (1.50 g, 4 mmol) and dibenzoylacetylene (0.94 g, 4 mmol) in 25 mL of acetonitrile was stirred for about 2h at RT. The progress of the reaction was monitored by TLC. After the reaction was complete, the reaction mixture was cooled, the yellow precipitate formed was separated, washed with a little of acetonitrile, and dried to get 1-(4-bromophenyl)-2-cyano-3,4-dibenzoyl-5-(2,2'-biphenyl)-2,5-dihydro-1H-pyrazole (**9b**).

Yield 1.89 g, 78%; mp 178 °C

IR (KBr) ν_{\max} : 2227(C≡N), 1662 and 1649 (C=O), 1611 cm^{-1} (C=C in conjugation with -COPh).;

¹H NMR (CDCl₃): δ 6.78-7.65 (m, 22H);

¹³C NMR (CDCl₃): δ 187.32, 184.36, 143.41, 142.13, 141.36, 140.10, 138.28, 136.41, 134.31, 132.82, 130.07, 128.79, 128.69, 128.20, 128.12, 127.04, 125.44, 120.58, 120.46, 109.47, 96.08;

FAB-MS: m/z calculated for $C_{36}H_{22}BrN_3O_2$: 607 (M^+); measured: m/z 608 ($M^+ + 1$).

Elemental analysis calculated for $C_{36}H_{22}BrN_3O_2$: C, 71.06; H, 3.64; Br, 13.13; N, 6.91; O, 5.26%; found: C, 71.10; H, 3.72; N, 6.86%.

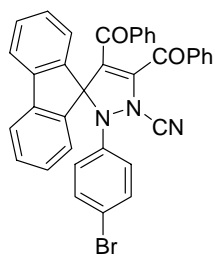

4.4.16. Synthesis of Compound 9c:

A mixture of N^α -fluorenylidene- N^α -(4-nitrophenyl)- N^β -cyanoazomethine imine (1.36 g, 4 mmol) and dibenzoylacetylene (0.94 g, 4 mmol) in 25 mL of acetonitrile was stirred for about 2h at RT. The progress of the reaction was monitored by TLC. After the reaction was complete, the reaction mixture was cooled, the yellow precipitate formed was separated, washed with a little acetonitrile, and dried to get 1-(4-nitrophenyl)-2-cyano-3,4-dibenzoyl-5-(2,2'-biphenyl)-2,5-dihydro-1*H*-pyrazole (**9c**).

Yield 1.75 g, 76%; mp 181 °C

IR (KBr) ν_{\max} : 2224 (C≡N), 1665 and 1639 (C=O), 1610 cm^{-1} (C=C in conjugation with –COPh);

¹H NMR (CDCl₃): δ 6.93-7.64 (m, 22H);

¹³C NMR (CDCl₃): δ 187.31, 184.48, 144.22, 141.38, 140.14, 138.28, 136.39, 134.30, 132.82, 130.07, 128.74, 128.69, 128.20, 128.16, 128.10, 127.06, 125.48, 120.58, 120.42, 109.47, 96.12;

FAB-MS: m/z calculated for C₃₆H₂₂N₄O₄: 574 (M⁺); measured: m/z 575 (M⁺+1). Elemental analysis calculated for C₃₆H₂₂N₄O₄: C, 75.25; H, 3.86; N, 9.75; O, 11.4%; found: C, 75.18; H, 3.91; N, 9.44%.

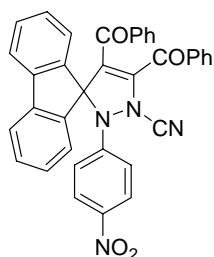

4.4.17. Synthesis of Compound 10a:

1-(4-Chlorophenyl)-2-cyano-3,4-dibenzoyl-5-(2,2'-biphenyl)-2,5-dihydro-1*H*-pyrazole (0.57 g, 1 mmol) was dissolved in minimum amount of DCM. The solution was then introduced to the top of a silica gel column.

It was eluted with 1:10 DCM-hexane mixture. On evaporating off the solvent, 1-(4-chlorophenyl)-3,4-dibenzoyl-5-(2,2'-biphenyl)-4,5-dihydro-1*H*-pyrazole (**10a**) was obtained in good yields.

Yield 0.50 g, 92%; mp 180 °C

IR (KBr) ν_{\max} : 1684 and 1649 (C=O), 1545 cm^{-1} (C=N);

^1H NMR (CDCl_3): δ 6.59-8.4 (m, 22H), 5.80 (s, 1H);

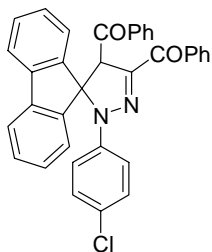

^{13}C NMR (CDCl_3): δ 193.3, 185.95, 147.05, 146.74, 139.83, 139.74, 136.18, 132.98, 132.67, 130.38, 130.31, 130.01, 129.70, 129.29, 128.81, 128.24, 128.12, 127.97, 127.45, 127.17, 123.42, 120.66, 120.24, 117.09, 96.18, 63.94;

FAB-MS: m/z calculated for $\text{C}_{35}\text{H}_{23}\text{ClN}_2\text{O}_2$: 538 (M^+); measured: m/z 539 (M^++1).

Elemental analysis calculated for $\text{C}_{35}\text{H}_{23}\text{ClN}_2\text{O}_2$: C, 77.99; H, 4.30; Cl, 6.58; N, 5.20; O, 5.94%; found: C, 77.92; H, 4.25; N, 5.24%.

4.4.18. Synthesis of Compound 10b:

1-(4-Bromophenyl)-2-cyano-3,4-dibenzoyl-5-(2,2'-biphenyl)-2,5-dihydro-1*H*-pyrazole (0.61 g, 1 mmol) was dissolved in minimum amount of DCM. The solution was then introduced to the top of a silica gel column. It was eluted with 1:10 DCM-hexane mixture. On evaporating off the solvent, 1-(4-bromophenyl)-3,4-dibenzoyl-5-(2,2'-biphenyl)-4,5-dihydro-1*H*-pyrazole (**10b**) was obtained in good yields.

Yield 0.55 g, 94%; mp 182 °C

IR (KBr) ν_{\max} : 1683 and 1649 (C=O),
1543 cm^{-1} (C=N);

^1H NMR (CDCl_3): δ 6.58-8.43 (m, 22H), 5.83
(s, 1H);

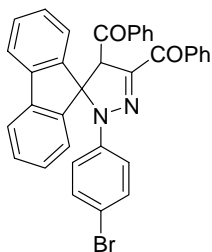

^{13}C NMR (CDCl_3): δ 193.28, 185.94, 147.10,
146.52, 139.83, 139.72, 136.21, 132.82,
132.68, 130.38, 130.31, 130.06, 129.70,
129.29, 128.82, 128.24, 128.18, 127.97,
127.45, 127.17, 123.44, 120.66, 120.24,
117.09, 96.18, 63.90;

FAB-MS: m/z calculated for $\text{C}_{35}\text{H}_{23}\text{BrN}_2\text{O}_2$:
582 (M^+); measured: m/z 583 (M^++1).

Elemental analysis calculated for
 $\text{C}_{35}\text{H}_{23}\text{BrN}_2\text{O}_2$: C, 72.05; H, 3.97; Br, 13.69;
N, 4.80; O, 5.48%; found: C, 72.06; H, 3.98;
N, 4.92%.

4.4.19. Synthesis of Compound 10c:

1-(4-Nitrophenyl)-2-cyano-3,4-dibenzoyl-5-(2,2'-biphenyl)-2,5-dihydro-1*H*-pyrazole (0.58 g, 1mmol) of was dissolved in minimum amount of DCM. The solution was then introduced to the top of a silica gel column. It was eluted with 1:10 DCM-hexane mixture. On evaporating off the solvent, 1-(4-nitrophenyl)-3,4-dibenzoyl-5-(2,2'-biphenyl)-4,5-dihydro-1*H*-pyrazole (**10c**) was obtained in good yields.

Yield 0.51 g, 93%; mp 178 °C

IR (KBr) ν_{\max} : 1680 and 1650 (C=O), 1543 cm^{-1} (C=N);

$^1\text{H NMR}$ (CDCl_3): δ 6.88-8.40 (m, 22H), 5.84 (s, 1H);

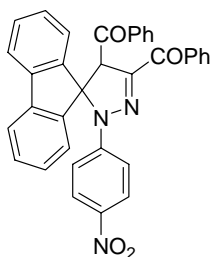

$^{13}\text{C NMR}$ (CDCl_3): δ 193.22, 185.93, 147.10, 146.92, 139.83, 139.74, 136.21, 132.82, 132.68, 130.38, 130.34, 130.06, 129.70, 129.29, 128.80, 128.24, 128.18, 127.96, 127.45, 127.17, 123.44, 120.66, 120.26, 117.06, 96.12, 63.88;

FAB-MS: m/z calculated for $\text{C}_{35}\text{H}_{23}\text{N}_3\text{O}_4$: 549 (M^+); measured: m/z 550 (M^++1).

Elemental analysis calculated for $\text{C}_{35}\text{H}_{23}\text{N}_3\text{O}_4$: C, 76.49; H, 4.22; N, 7.65; O, 11.64%; found: C, 76.54; H, 4.11; N, 7.67%.

4.4.20. Synthesis of Compound 12a:

A mixture of N^α -diphenylmethylene- N^α -(4-chlorophenyl)- N^β -cyanoazomethine imine (1.33 g, 4 mmol) and dibenzoylacetylene (0.94 g, 4 mmol) in 25 mL of acetonitrile was stirred for about 2h at RT. The progress of the reaction was monitored by TLC. After the reaction was complete, the reaction mixture was cooled, the yellow precipitate formed was separated, washed with a little acetonitrile, and dried to get 1-(4-chlorophenyl)-2-cyano-3,4-dibenzoyl-5,5-diphenyl-2,5-dihydro-1H-pyrazole (**12a**).

Yield 1.81 g, 80%; mp 176 °C

IR (KBr) ν_{\max} : 2224 (C≡N), 1666 and 1640 (C=O), 1595 cm^{-1} (C=C in conjugation with -COPh);

¹H NMR (CDCl₃): δ 6.85-7.46 (m, 24H);

¹³C NMR (CDCl₃): δ 186.54, 184.32, 143.48, 142.68, 140.37, 138.22, 136.58, 134.27, 132.61, 131.20, 129.42, 128.73, 128.58, 128.43, 128.28, 128.20, 126.40, 123.38, 109.98, 96.07;

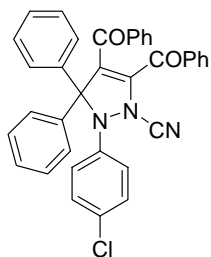

FAB-MS: m/z calculated for C₃₆H₂₄ClN₃O₂: 563 (M⁺); measured: m/z 564 (M⁺+1).

Elemental analysis calculated for C₃₆H₂₄ClN₃O₂: C, 76.39; H, 4.27; Cl, 6.26; N, 7.42; O, 5.65%; found: C, 76.27; H, 4.32; N, 7.44%.

4.4.21. Synthesis of Compound 12b:

A mixture of *N*^α-diphenylmethylene-*N*^α-(4-bromophenyl)-*N*^β-cyanoazomethine imine (1.50 g, 4 mmol) and dibenzoylacetylene (0.94 g, 4 mmol) in 25 mL of acetonitrile was stirred for about 2h at RT. The progress of the reaction was monitored by TLC. After the reaction was complete, the reaction mixture was cooled, the yellow precipitate formed was separated, washed with a little acetonitrile, and dried to get 1-(4-bromophenyl)-2-cyano-3,4-dibenzoyl-5,5-diphenyl-2,5-dihydro-1*H*-pyrazole (**12b**).

Yield 1.97 g, 81%; mp 180 °C

IR (KBr) ν_{\max} : 2222 (C≡N), 1662 and 1640 (C=O), 1594 cm^{-1} (C=C in conjugation with -COPh).;

¹H NMR (CDCl₃): δ 6.80-7.48 (m, 24H);

¹³C NMR (CDCl₃): δ 186.23, 184.31, 143.41, 142.38, 140.42, 138.21, 136.58, 134.27, 132.61, 131.20, 129.41, 128.73, 128.60, 128.43, 128.30, 128.20, 126.40, 123.34, 107.92, 96.07;

FAB-MS: m/z calculated for C₃₆H₂₄BrN₃O₂: 609 (M⁺); measured: m/z 610 (M⁺+1).

Elemental analysis calculated for C₃₆H₂₄BrN₃O₂: C, 70.82; H, 3.98; Br, 12.84; N, 6.92; O, 5.26%; found: C, 71.00; H, 3.96; N, 6.88%.

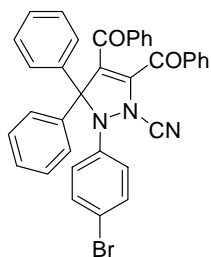

4.4.22. Synthesis of Compound 12c:

A mixture of *N*^α-diphenylmethylene-*N*^β-(4-nitrophenyl)-*N*^β-cyanoazomethine imine (1.36 g, 4 mmol) and dibenzoylacetylene (0.94 g, 4 mmol) in 25 mL of acetonitrile was stirred for about 2 h at RT. The progress of the reaction was monitored by TLC. After the reaction was complete, the reaction mixture was cooled, the yellow precipitate formed was separated, washed with a little acetonitrile, and dried to get 1-(4-chlorophenyl)-2-cyano-3,4-dibenzoyl-5,5-diphenyl-2,5-dihydro-1*H*-pyrazole (**12c**).

Yield 1.84 g, 80%; mp 172 °C

IR (KBr) ν_{\max} : 2226 (C≡N), 1662 and 1641 (C=O), 1592 cm^{-1} (C=C in conjugation with -COPh);

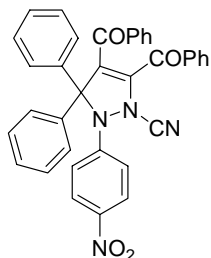

$^1\text{H NMR}$ (CDCl_3): δ 6.78-7.47 (m, 24H);

$^{13}\text{C NMR}$ (CDCl_3): δ 186.46, 184.34, 143.41, 142.40, 140.42, 138.23, 136.58, 134.27, 132.62, 131.22, 129.42, 128.73, 128.64, 128.44, 128.30, 128.20, 126.40, 123.34, 107.92, 96.08;

FAB-MS: m/z calculated for $\text{C}_{36}\text{H}_{24}\text{N}_4\text{O}_4$: 576 (M^+); measured: m/z 577 (M^++1).

Elemental analysis calculated for $\text{C}_{36}\text{H}_{24}\text{N}_4\text{O}_4$: C, 74.99; H, 4.20; N, 9.72; O, 11.10%; found: C, 74.60; H, 4.35; N, 9.81%.

4.4.23. Synthesis of Compound 13a:

About 0.57 g (1mmol) of 1-(4-chlorophenyl)-2-cyano-3,4-dibenzoyl-5,5-diphenyl-2,5-dihydro-1H-pyrazole was dissolved in minimum amount of DCM. The solution was then introduced to the top of a silica gel column. It was eluted with 1:10 DCM-hexane mixture. On evaporating off the solvent, 1-(4-chlorophenyl)-3,4-dibenzoyl-5,5-diphenyl-4,5-dihydro-1H-pyrazole (**13a**) was obtained in good yields.

Yield 0.51 g, 95%; mp 170 °C

IR (KBr) ν_{\max} : 1687 and 1648 (C=O),
1542 cm^{-1} (C=N);

^1H NMR (CDCl_3): δ 6.80 to δ 7.68 (m, 24H),
5.22 (s, 1H);

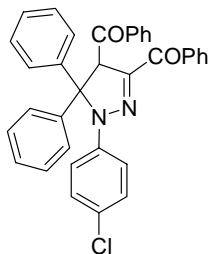

^{13}C NMR (CDCl_3): δ 192.3, 183.90, 147.02,
143.42, 139.79, 138.74, 136.16, 134.25,
132.98, 132.64, 130.41, 130.32, 129.30,
128.85, 128.16, 127.94, 127.45, 126.24,
123.41, 96.09, 64.02;

FAB-MS: m/z calculated for $\text{C}_{35}\text{H}_{25}\text{ClN}_2\text{O}_2$:
540 (M^+); measured: m/z 541 ($\text{M}^+ + 1$).

Elemental analysis calculated for
 $\text{C}_{35}\text{H}_{25}\text{ClN}_2\text{O}_2$: C, 77.70; H, 4.66; Cl, 6.55; N,
5.18; O, 5.91%; found: C, 77.36; H, 4.72; N,
5.12%.

4.4.24. Synthesis of Compound 13b:

About 0.62 g (1mmol) of 1-(4-bromophenyl)-2-cyano-3,4-dibenzoyl-5,5-diphenyl-2,5-dihydro-1H-pyrazole was dissolved in minimum amount of DCM. The solution was then introduced to the top of a silica gel column. It was eluted with 1:10 DCM-hexane mixture. On evaporating off the solvent, 1-(4-bromophenyl)-3,4-dibenzoyl-5,5-diphenyl-4,5-dihydro-1H-pyrazole (**13b**) was obtained in good yields.

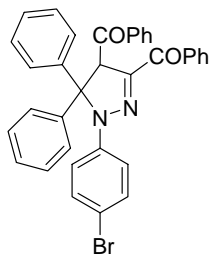

Yield 0.53 g, 91%; mp 184 °C

IR (KBr) ν_{\max} : 1687 and 1649 (C=O), 1542 cm^{-1} (C=N);

^1H NMR (CDCl_3): δ 6.80 to δ 7.71 (m, 24H), 5.24 (s, 1H);

^{13}C NMR (CDCl_3): δ 193.08, 184.02, 147.04, 143.42, 139.79, 137.80, 136.10, 134.25, 132.78, 132.62, 130.42, 130.32, 129.30, 128.78, 128.16, 127.60, 127.45, 126.24, 122.60, 96.16, 63.88;

FAB-MS: m/z calculated for $\text{C}_{35}\text{H}_{25}\text{BrN}_2\text{O}_2$: 584 (M^+); measured: m/z 585 ($\text{M}^+ + 1$).

Elemental analysis calculated for $\text{C}_{35}\text{H}_{25}\text{BrN}_2\text{O}_2$: C, 71.80; H, 4.30; Br, 13.65; N, 4.78; O, 5.47%; found: C, 72.10; H, 4.22; N, 4.64%.

4.4.25. Synthesis of Compound 13c:

About 0.58 g (1mmol) of 1-(4-nitrophenyl)-2-cyano-3,4-dibenzoyl-5,5-diphenyl-2,5-dihydro-1*H*-pyrazole was dissolved in minimum amount of DCM. The solution was then introduced to the top of a silica gel column. It was eluted with 1:10 DCM-hexane mixture. On evaporating off the solvent, 1-(4-nitrophenyl)-3,4-dibenzoyl-5,5-diphenyl-4,5-dihydro-1*H*-pyrazole (**13c**) was obtained in good yields.

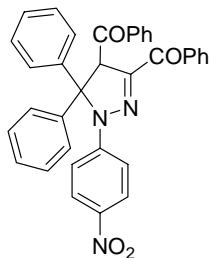

Yield 0.51 g, 92%; mp 178 °C

IR (KBr) ν_{max} : 1683 and 1641 (C=O), 1543 cm^{-1} (C=N);

^1H NMR (400 MHz, CDCl_3): δ 6.92 to δ 7.73 (m, 24H), 5.20 (s, 1H);

^{13}C NMR (CDCl_3): δ 193.00, 183.60, 146.72, 143.22, 139.72, 138.78, 136.16, 134.25, 132.93, 132.65, 130.41, 130.32, 129.31, 128.85, 128.20, 127.94, 127.38, 126.24, 123.42, 96.10, 63.84;

FAB-MS: m/z calculated for $\text{C}_{35}\text{H}_{25}\text{N}_3\text{O}_4$: 551 (M^+); measured: m/z 552 (M^++1). Elemental analysis calculated for $\text{C}_{35}\text{H}_{25}\text{N}_3\text{O}_4$: C, 76.21; H, 4.57; N, 7.62; O, 11.60%; found: C, 76.28; H, 4.48; N, 7.66%.

4.4.26. Synthesis of Compound 15

A mixture of N^α -fluorenylidene- N^α -(4-chlorophenyl)- N^β -cyanoazomethine imine (1.65 g, 5 mmol) and DMAD (0.71 g, 5 mmol) in 25 mL of acetonitrile was stirred for about 2 h at RT. The progress of the reaction was monitored by TLC. When the reaction was complete, the reaction mixture was cooled, the white precipitate formed was washed with a little acetonitrile, and dried to get dimethyl-1-(4-chlorophenyl)-2-cyano-5-(2,2'-biphenyl)-2,5-dihydro-1H-pyrazole-3,4-dicarboxylate (**15**).

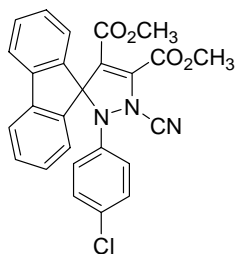

Yield 1.70 g, 72%; mp 142 °C

IR (KBr) ν_{\max} : 2225 (C≡N), 1743 and 1736 cm^{-1} (C=O);

¹H NMR (CDCl₃): δ 6.54-7.59 (m, 12H), 3.35 (s, 3H), 4.04 (s, 3H);

¹³C NMR (CDCl₃): δ 160.12, 157.66, 142.82, 141.87, 140.01, 131.79, 130.14, 128.63, 128.17, 125.92, 122.24, 120.58, 120.14, 109.42, 96.15, 53.71, 52.22;

FAB-MS: m/z calculated for C₂₆H₁₈ClN₃O₄: 471 (M⁺); measured: m/z 472 (M⁺+1).

Elemental analysis calculated for C₂₆H₁₈ClN₃O₄: C, 66.18; H, 3.84; Cl, 7.51, N, 8.9, O, 13.56%; found: C, 66.21; H, 3.94; N, 8.81%.

4.4.27. Attempted decyanation of compound 15 with silica gel:

About 0.47 g (1mmol) of dimethyl 1-(4-chlorophenyl)-2-cyano-5-(2,2'-biphenyl)-2,5-dihydro-1H-pyrazole-3,4-dicarboxylate was dissolved in minimum amount of DCM. The solution was then introduced to the top of a silica gel column. It was eluted with 1:10 DCM-hexane mixture. On evaporating off the solvent the starting material was recovered.

4.4.28. Attempted decyanation compound 15 of with oxalic acid adsorbed on silica gel

A mixture of oxalic acid (0.13 g, 1mmol) and silica gel (2 g) in 10 mL of dichloromethane was stirred for about 30 min. About 0.47 g (1mmol) of dimethyl 1-(4-chlorophenyl)-2-cyano-5-(2,2'-biphenyl)-2,5-dihydro-1H-pyrazole-3,4-dicarboxylate in 20 mL DCM was added to the

above solution and stirred for about 6h. The reaction mixture was extracted with DCM. The solution was concentrated and introduced to the top of a silica gel column. It was eluted with 1:10 DCM-hexane mixture. On evaporating off the solvent the starting material was recovered.

4.5. References

1. Cordoba, M. M.; Izquierdo, M. L.; Alvarez-Builla, J. *Tetrahedron* **2008**, *64*, 7914.
2. Huisgen, R. *J. Org. Chem.* **1976**, *41*, 403.
3. Schad, P. *Ber. Dtsch. Chem. Ges.* **1893**, *26*, 216.
4. Huisgen, R. *Angew. Chem., Int. Ed. Engl.* **1963**, *2*, 565.
5. Huisgen, R.; Gotthardt, H. *Chem. Ber.* **1968**, *101*, 1059.
6. Oppolzer, W. *Angew. Chem., Int. Ed. Engl.* **1977**, *16*, 10.
7. Grigg, R.; Kemp, J.; Thompson, N. *Tetrahedron Lett.* **1978**, *31*, 2827.
8. Le Fevre, G.; Sinbandhit, S.; Hamelin, J. *Tetrahedron* **1979**, *35*, 1821.
9. Kuznetsov, M. A. *Russ. Chem. Rev.* **1979**, *48*, 563.
10. Markert, J.; Fahr, E. *Tetrahedron Lett.* **1970**, 769.
11. Gergely, J.; Morgan, J. B.; Overman, L. E. *J. Org. Chem.* **2006**, *71*, 9144.
12. Huisgen, R.; Fleischmann, R.; Eckell, A. *Chem. Ber.* **1977**, *110*, 500.
13. Flippen-Anderson, J. L.; Karle, I.; Huisgen, R.; Reissig, H. U. *Angew. Chem., Int. Ed. Engl.* **1980**, *19*, 906.
14. Stuckwisch, C. G. *Synthesis* **1973**, 469.
15. Barbera, J.; Clays, K.; Gimenez, R.; Houbrechts, S.; Persoons, A.;

- Serrano, J. L. *J. Mater. Chem.* **1998**, *8*, 1725.
16. Wang, M.; Zhang, J.; Liu, J.; Xu, C.; Ju, H. *J. Lumin.* **2002**, *99*, 79.
17. Lu, Z.; Jiang, Q.; Zhu, W.; Xie, M.; Hou, Y.; Chen, X.; Wang, Z. *Synth. Metals* **2000**, *111*, 465.
18. Borsenberger, P. M.; Schein, L. B. *J. Phys. Chem.* **1994**, *98*, 233.
19. Zhang, X. H.; Lai, W. Y.; Wu, S. K. *Chem. Phys. Lett.* **2000**, *320*, 77.
20. Ozdemir, Z.; Kandilici, H. B.; Gumusel, B.; Calis, U.; Bilgin, A. A. *Eur. J. Med. Chem.* **2007**, *42*, 373.
21. Taylor, E. C.; Patel, H. H. *Tetrahedron* **1992**, *48*, 8089.
22. Palaskar, E.; Aytemir, M.; Uzbay, I. T.; Erol, D. *Eur. J. Med. Chem.* **2001**, *36*, 539.
23. Kargaokar, S. S.; Patil, P. H.; Shah, M. T.; Parekh, H. H.; *Indian J. Pharm. Sci.* **1996**, *58*, 222.
24. Doyle, M. P.; Bryker, W. J. *J. Org. Chem.* **1979**, *44*, 1572.
25. Broxton, T. J.; Bunnett, J. F.; Paik, C. H. *J. Org. Chem.* **1977**, *42*, 643.
26. Ahern, M. F.; Leopold, A.; Beadle, J. R.; Gokel, G. W. *J. Am. Chem. Soc.* **1982**, *104*, 548.
27. Eckell, A.; Huisgen, R. *Chem. Ber.* **1977**, *110*, 559.

Outcome

1,3-Dipolar Cycloaddition-A Case study

From the results of our present study, it is clear that two 1,3-dipoles, azomethine oxide and azomethine imine, belonging to the same category exhibit a dramatic variation in their reactivity pattern with a common dipolarophile. In this section, we include our arguments to account for the observed selectivity.

As mentioned in the introductory chapter, three distinct reaction mechanisms were proposed originally for 1,3-dipolar cycloaddition. Huisgen proposed the first mechanism, which involves concerted bond formation between the dipole and the dipolarophile. Firestone proposed a stepwise mechanism involving a diradical intermediate. To date, however, no convincing experimental evidence has been reported that supports the diradical mechanism. The third possible pathway is *via* a zwitterionic intermediate. Huisgen experimentally proved this possibility and he described them as exceptional cases. This was the background of our present study. We deliberately selected two 1,3-dipoles, namely azomethine oxides (nitrones) and azomethine imines, belonging to allyl anion type; and a common dipolarophile, dibenzoylacetylene, an acetylene with anion stabilizing groups.

The dipole moment measurement as well as its reactions with ketenes, ketenimines, *etc* shows that nitrones can behave like nucleophiles. So we reasoned that if the dipolarophile contains anion stabilizing groups, it will definitely open the door to the stepwise reaction. If such an alternate pathway is possible, in addition to the electronic parameters, the steric parameters will also influence the course of the reaction. To verify this, we employed nitrones

with varying substituents on the α -C. The experimental results confirmed the proposed mechanism, i.e., zwitterion mediated two-step reaction.

To verify the proposed mechanism involving initial nucleophilic attack, we selected azomethine imines, where we changed the electronic environment of the dipole, especially the nucleophilicity. Nucleophilicity of azomethine imine is reduced by anchoring a cyano group - an electron withdrawing group - to the nucleophilic terminus of the dipole. Here we observed the cyclisation of the zwitterionic intermediate as the most probable reaction pathway.

According to Huisgen the term concerted does not necessarily imply that the two new σ bonds are developed in the transition state to precisely the same extent. The perfect synchrony is possible to observe only in the case of systems with high symmetry in 1,3-dipole and dipolarophile. The 1,3-dipole that differs in the electrophilic and nucleophilic properties of the termini, and dipolarophile polarized by their substitution pattern, will undergo concerted but not necessarily synchronous cycloaddition (Figure 1)

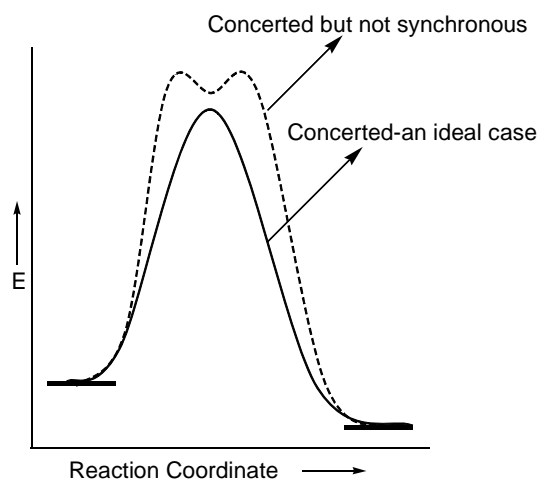

Figure1. Energy Profiles for concerted and stepwise mechanisms of 1,3-dipolar cycloaddition reactions.

The experimental observations can be explained by considering steric as well as electronic parameters of dipoles and dipolarophiles. In the case of nitrene cycloaddition, the significant observations are:

- i) The major product formed is a 1:1 adduct when α -C of nitrene is sterically hindered.
- ii) Formation of this 1:1 adduct can be explained only by considering a zwitterion mediated reaction pathway.
- iii) The other two compounds obtained as minor became the major when steric barrier offered by the α -C is reduced.
- iv) Sum of the m/z values of minor products is exactly equal to sum of the masses of 1:1 adduct and H₂O. This means that hydrolysis of nitrene-DBA adduct is taking place at some stage of the reaction.
- v) The isolated 1:1 adduct was separately subjected to mild hydrolysis and the set of products formed was different from the one obtained in the nitrene-DBA cycloaddition reaction. This ruled out the possibility for the hydrolysis of the isolated 1:1 adduct under the reaction condition.
- vi) When the same reaction was conducted in acetonitrile containing water as well as in methanol, no noticeable change in product distribution was observed. Hence the hydrolysis step manifests at a later stage in the reaction sequence.

Together with these experimental observations, the lability/instability of *N*-aryl substituted isoxazolines and oxazolines prompted us to propose a mechanism which involves two competing path ways (Figure 2).

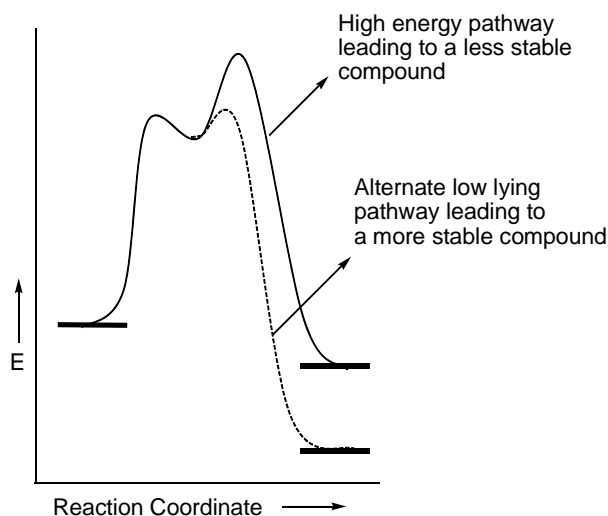

Figure 2 Energy profile for stepwise mechanism with competing pathways.

The pronounced nucleophilic nature of *N*-fluorenylidene-*N*-aryl nitrones as well as *N*-diphenylmethylene-*N*-arylnitrones makes their nucleophilic attack on the acetylenic dipolarophile a rather fast process. The anion stabilizing group gives some thermodynamic stability for the zwitterionic intermediate whereas steric hindrance on α -C of nitrones kinetically retards intramolecular cyclisation. Additionally, isoxazolines generated by direct cyclisation are unstable molecules. Since intramolecular cyclisation of the zwitterion is kinetically retarded, the system prefers other alternative pathways involving comparatively lower energy transition states where such steric hindrance is not expected. Our experimental observations are in good agreement with this argument. When substantial crowding is present on α -C, [3,3]-sigmatropic shift was the major reaction pathway. When steric hindrance on the α -C of nitrone is gradually reduced, intramolecular cyclisation of the zwitterion becomes more and more prominent. In the case of *N*-phenylmethylene-*N*-arylnitrones, intramolecular cyclisation of the zwitterion is the only observed reaction pathway.

If the rate of formation of the zwitterion lags behind the rate of its intramolecular cyclisation and if the product thus obtained is fairly stable, there is every chance for the reaction to pass through a single intramolecular pathway (Figure 3). One of the factors which influence the rate of initial nucleophilic attack is the nucleophilicity of the dipole. The rate of attack is expected to decrease with decreasing nucleophilicity of the dipole. Azomethine imine with an electron withdrawing group, for e.g., cyano group attached to the nucleophilic terminus of the dipole is employed for this purpose. The experimental observations i.e., the formation of pyrazolines as the sole product, verified our arguments.

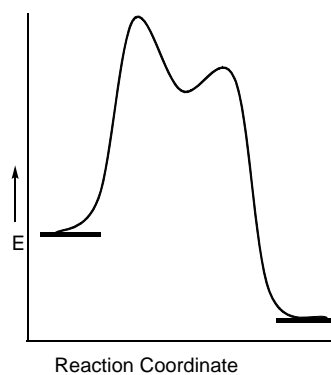

Figure 3. Energy profile for a stepwise cycloaddition reaction leading to a reasonably stable compound.

Finally, we conclude that dipolar additions can follow a zwitterionic mechanism. In the absence of a favorable alternative, cycloaddition is the only observed transformation. When stage is set for lower energy alternatives, other transformations of zwitterionic intermediates might manifest.

Were we the first to observe stepwise addition in alleged 1,3-cycloadditions? The answer here is NO! Several investigators encountered but failed to recognize stepwise reaction sequences since it was

presumed that all 1,3-additions are concerted. We have shown that more credible alternative mechanisms can be proposed for the generation of products formed in some of these reactions. We suggest that a paradigm shift is obligatory here: Based on findings reported in this thesis, 1,3-dipolar addition reactions, especially those employing nitrones should not be *a priori* classified as cycloadditions. These might better qualify as stepwise reactions and alternative mechanism should be considered for the generation of various products in these reactions.

Over the past several years, our group maintained an active research program on the generation of 2(3*H*)- and 3(2*H*)-furanones. Most surprisingly, while investigating the course of 1,3-dipolar additions, we serendipitously discovered facile routes for the synthesis of pharmacologically as well as synthetically significant 3(2*H*)-furanones through hitherto unknown pathways. We could also generate novel routes for the synthesis of highly substituted quinoline derivatives by the hydrolysis of a few 3(2*H*)-furanones synthesized by us.

“No great discovery was ever made without a bold guess”.

Sir Isaac Newton

List of Publications

1. Preliminary Investigations on the Synthesis and Antitumor Activity of 3(2*H*)-Furanones. **Rappai, J. P.**; Raman, V.; Unnikrishnan, P. A.; Prathapan, S.; Thomas, S. K.; Paulose, C. S. *Bioorg. Med. Chem. Lett.* **2009**, *19*, 764.*
2. A Comparative Study of Energy Transfer in Dye Mixtures in Monomer and Polymer Matrices under Pulsed Laser Excitation. Kailasnath, M.; **John, P. R.**; Radhakrishnan, P.; Nampoore, V. P. N. *J. Photochem. Photobiol. A: Chem.* **2008**, *195*, 135.*
3. Simple, Efficient, and Stereoselective Oxidation of Triphenylfurans to *cis*-But-2-ene-1,4-diones. **Rappai, J. P.**; Prathapan, S.; Vishnu Unni, M. V.; Unnikrishnan, P. A. *Synth. Commun.* **2007**, *37*, 569.*
4. A Simple and Efficient One-pot Synthesis of Nitriles from Amides and Oximes using *in situ* generated Burgess-type Reagent. **Rappai, J. P.**; Karthikeyan J.; Prathapan, S.; Unnikrishnan, P. A. *Synth. Commun.* (Communicated).*
5. 1,3-Dipolar Cycloadditions: Mechanism Revisited. **Rappai, J. P.**; Prathapan, S.; Guru Row, T. N.; Unnikrishnan, P. A. *J. Am. Chem. Soc.* (Communicated).
6. Atom Efficient Synthesis of Highly Substituted Quinolines. **Rappai, J. P.**; Prathapan, S.; Rath, N. P.; Unnikrishnan, P. A. *Org. Lett.* (Communicated).
7. A Novel One-step Method for the Synthesis of 3(2*H*)-Furanones. **Rappai, J. P.**; Prathapan, S.; Rath, N. P.; Unnikrishnan, P. A. *J. Heterocycl. Chem.* (Under preparation).

Poster Presented at International Conference

1. Synthesis and Transformations of a few Spiropyrazolines. **Rappai, J. P.**; Prathapan, S.; Unnikrishnan, P. A. *Proc. Int. Con. Materials for the Millennium (MatCon 2010)* **2010**, pp 201.

*Not the part of work presented in this thesis.