

T471



**NOVEL MULTICOMPONENT REACTIONS
BASED ON TRIPHENYLPHOSPHINE,
DIMETHOXYCARBENE AND ISOCYANIDE
SYNTHESIS OF PHOSPHORANES AND
OXYGEN HETEROCYCLES**

**THESIS SUBMITTED TO COCHIN UNIVERSITY OF SCIENCE
AND TECHNOLOGY IN FULFILMENT OF THE
REQUIREMENTS FOR
THE DEGREE OF
DOCTOR OF PHILOSOPHY
IN CHEMISTRY UNDER THE FACULTY OF SCIENCE**

**BY
ANI DEEPTHI**

**UNDER THE SUPERVISION OF
Dr. G. VIJAY NAIR**



**ORGANIC CHEMISTRY SECTION
REGIONAL RESEARCH LABORATORY (CSIR)
THIRUVANANTHAPURAM-695 019
KERALA, INDIA**

JUNE 2006

DECLARATION

I hereby declare that the matter embodied in the thesis entitled "**Novel Multicomponent Reactions Based on Triphenylphosphine, Dimethoxycarbene and Isocyanide – Synthesis of Phosphoranes and Oxygen Heterocycles**" is the result of the investigations carried out by me in the Organic Chemistry Section of Regional Research Laboratory (CSIR), Trivandrum, under the supervision of **Dr. G. Vijay Nair** and the same has not been submitted elsewhere for a degree.



Ani Deepthi

Trivandrum

June 2006



Dr. G. Vijay Nair, F. A. Sc.
Organic Chemistry Section

REGIONAL RESEARCH LABORATORY (CSIR)
GOVERNMENT OF INDIA

TRIVANDRUM-695 019, INDIA

Telephone: 91-471-2490406; Fax: 91-471-2491712

CERTIFICATE

This is to certify that the work embodied in the thesis entitled "**Novel Multicomponent Reactions Based on Triphenylphosphine, Dimethoxycarbene and Isocyanide – Synthesis of Phosphoranes and Oxygen Heterocycles**" was carried out by **Ms. Ani Deepthi** under my supervision at the Organic Chemistry Section of the Regional Research Laboratory (CSIR), Trivandrum, and the same has not been submitted elsewhere for any other degree.

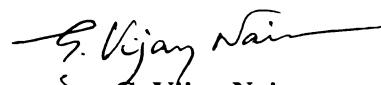
G. Vijay Nair
(Thesis Supervisor)

Trivandrum

June 2006

email: vijaynair_2001@yahoo.com

Acknowledgements

It is with great respect that I express my deep sense of gratitude and obligation to my teacher and research supervisor Dr. Vijay Nair for his constant encouragement, intellectual inspiration and constructive criticism.

I am thankful to the Director, Regional Research Laboratory, for providing all the laboratory facilities to carry out this work.

My sincere thanks are also due to:

- ◆ *Dr S. Bindu, Mr. V. Sreekumar, Dr. Roshini Rajan and Dr. Rajeev S. Menon for their help and support during various stages of my doctoral studies.*
- ◆ *Dr. Mangalam S. Nair, Dr. Luxmi Varma, Dr. K. V. Radhakrishnan and Dr. P. Shanmugham, Scientists of Organic Chemistry Section for their help and valuable suggestions.*
- ◆ *Mrs. Saumini Mathew, Mrs. S. Viji and Mr. Thirumalai for recording NMR spectra, High Resolution Mass Spectra and for CHN analysis.*
- ◆ *Dr. E. Suresh (Central Salt and Marine Chemicals Research Institute, Bhavnagar) for single crystal X-ray analysis.*
- ◆ *All the present and former colleagues of Organic Chemistry Section for their cooperation and help.*
- ◆ *All friends at Regional Research Laboratory, Trivandrum.*
- ◆ *CSIR, New Delhi for financial assistance.*

I wish to express my gratitude to all my teachers for the guidance and wisdom given to me.

Words are inadequate to express my feelings for the love, support and encouragement shown by my parents and brother throughout my academic career.

Ani Deepthi

Trivandrum

June, 2006

CONTENTS

Declaration	i
Certificate	ii
Acknowledgements	iii
Preface	vii
Abbreviations	ix
Chapter 1	
Multicomponent Reactions and Zwitterionic Chemistry:	
A Brief Introduction	1-29
1.1 Introduction	1
1.2 Multicomponent Reactions	1
1.2.1 The Passerini reaction	4
1.2.1.1 Asymmetric Passerini reaction	6
1.2.2 The Ugi reaction	6
1.2.2.1 Asymmetric Ugi reaction	8
1.2.3 Other isocyanide based MCRs	9
1.2.4 Non-Ugi type IMCRs	10
1.2.5 Other multicomponent transformations	11
1.2.6 Free radical mediated MCRs	12
1.3 Zwitterions	14
1.3.1 Addition of pyridine	14
1.3.2 Addition of isoquinoline	16
1.3.3 Addition of imines	17
1.3.4 Addition of enamines	18
1.3.5 Addition of sulphur compounds	19
1.3.6 Addition of phosphorus compounds	19
1.3.7 Addition of isocyanides	20
1.3.8 Addition of nucleophilic carbenes	21
1.3.8.1 Dialkoxycarbenes	21
1.3.8.2 N-Heterocyclic carbenes	22
1.4 Definition of the problem	23

1.5	References	24
-----	------------	----

Chapter 2

The Reaction of Triphenylphosphine-DMAD Zwitterion with Activated Styrenes – Synthesis of Highly Substituted Phosphoranes 30-68

2.1	Introduction	30
2.2	Phosphines as catalysts	30
2.3	Phosphines as stoichiometric reagents	40
2.4	Statement of the problem	42
2.5	Results and Discussion	42
2.6	Conclusion	53
2.7	Experimental Details	53
2.8	References	65

Chapter 3

The Reaction of Dimethoxycarbene-DMAD Zwitterion with 1,2-Diones - Synthesis of Dihydrofurans and Spirodihydrofurans 69-114

3.1	Introduction	69
3.2	Dialkoxycarbenes	69
3.2.1	Generation of Dialkoxycarbene	69
3.2.2	Reactions of Dialkoxycarbene	72
3.3	Isatins and Cyclobutenediones	80
3.4	Statement of the problem	84
3.5	Results and Discussion	84
3.6	Conclusion	97
3.7	Experimental Details	97
3.8	References	111

Chapter 4

The Reaction of Isocyanide-DMAD Zwitterion with Vicinal Tricarbonyl Systems - Synthesis of Highly Substituted Furan Derivatives 115-152

4.1	Introduction	115
4.2	Isocyanides	115

4.2.1	Synthesis of isocyanides	116
4.2.2	Chemistry of Isocyanides	117
4.2.2.1	α -Metallation	117
4.2.2.2	Radical reactions	118
4.2.2.3	Multicomponent reactions	120
4.2.2.4	Reactions of coordinated isocyanides	120
4.2.2.5	Miscellaneous reactions	121
4.3	Vicinal tricarbonyl compounds	124
4.3.1	Methods of preparation	125
4.3.1.1	From β -dicarbonyl compounds	125
4.3.1.2	From monoketones	125
4.3.1.3	SmI_2 mediated insertion of Isocyanides	126
4.3.1.4	Oxidation of Dihydroxy precursors	126
4.3.2	Reactions of tricarbonyl compounds	127
4.3.2.1	Reaction with nucleophiles	127
4.3.2.2	Rearrangement reactions	129
4.3.2.3	Thermolysis	129
4.3.2.4	Cycloaddition reactions	130
4.3.3	Ninhydrin	130
4.4	Statement of the problem	131
4.5	Results and Discussion	131
4.6	Conclusion	138
4.7	Experimental Details	139
4.8	References	148
	Summary	153
	List of Publications	156

PREFACE

Organic synthesis like any other human activity aims at achieving ideality. An ideal synthesis is one that can be performed in the most efficient and facile manner with maximum conversion. In this respect multicomponent reactions (MCRs) come very close to the concept of an ideal synthesis. Unlike conventional stepwise syntheses which are linear or divergent, in MCRs the starting materials combine convergently to form the product, thus causing considerable process time reduction. The monumental works of Passerini and Ugi have contributed greatly towards the development of MCRs. In the light of the extensive investigations by Rolf Huisgen on dipolar cycloaddition reactions, work in our laboratory has shown that a new strategy based on the addition of zwitterionic species to electrophiles constitutes a facile entry into a different class of MCRs. This novel strategy involves the reaction of various nucleophilic species, activated acetylene and electrophiles in one-pot to yield heterocyclic or carbocyclic products.

Neutral nucleophile like triphenylphosphine and nucleophilic carbenes like dimethoxycarbene and isocyanide have been known to form 1:1 zwitterionic intermediates with activated acetylenes for long. The present study aims at developing new MCRs based on the addition of these intermediates to electrophilic carbon-carbon and carbon-oxygen bonds. The results of our investigations in this area form the subject matter of the thesis entitled **“NOVEL MULTICOMPONENT REACTIONS BASED ON TRIPHENYLPHOSPHINE, DIMETHOXYCARBENE AND ISOCYANIDE – SYNTHESIS OF PHOSPHORANES AND OXYGEN HETEROCYCLES.”**

The thesis is divided into four chapters. Relevant references are given at the end of each chapter.

A general introduction to multicomponent reactions is given in the first chapter. A brief survey on various zwitterionic intermediates and the definition of the present research problem is also provided in this chapter.

The second chapter presents the results of our investigations of the reaction of 1:1 zwitterion of triphenylphosphine and DMAD with activated styrenes leading to the synthesis of highly substituted phosphoranes. General information on the experimental procedures is given in this chapter.

The third chapter describes a facile one pot synthesis of dihydrofurans and spirodihydrofurans by the multicomponent reaction of 1,2-dicarbonyl compounds with dimethoxycarbene and DMAD.

The results of our investigations on the application of vicinal tricarbonyl compounds in multicomponent reaction with DMAD and isocyanide leading to the one pot synthesis of 2-aminofurans and iminopyrones are disclosed in the fourth chapter.

It may be mentioned that each chapter of the thesis is presented as an independent unit and therefore the structural formulae, schemes and figures are numbered chapter wise.

A summary of the work is given towards the end of the thesis.

ABBREVIATIONS

bs	: broad singlet
Cy	: cyclohexyl
d	: doublet
dd	: doublet of doublet
de	: diastereomeric excess
DME	: 1,2-dimethoxyethane
DMF	: dimethyl formamide
DMAD	: dimethyl acetylenedicarboxylate
DMSO	: dimethyl sulfoxide
ee	: enantiomeric excess
EI	: electron impact
Et	: ethyl
FAB	: fast atom bombardment
HRMS	: high-resolution mass spectrum
Hz	: hertz
IR	: infrared
<i>J</i>	: coupling constant
LDA	: lithium diisopropylamide
m	: multiplet
Me	: methyl
mg	: milligram
mL	: millilitre
mp	: melting point
NMR	: nuclear magnetic resonance
<i>o</i> -Ns	: <i>o</i> -nitrobenzenesulfonamide
<i>o</i>	: ortho
<i>p</i>	: para
Ph	: phenyl
Pr	: <i>n</i> -propyl
s	: singlet
t	: triplet
Ts	: <i>p</i> -toluene sulfonyl
<i>tert</i>	: tertiary
TosMIC	: tosylmethyl isocyanide
TPP	: triphenyl phosphine

Multicomponent Reactions and Zwitterionic Chemistry: A Brief Introduction

1.1 Introduction

The conventional procedures in organic synthesis utilize stepwise formation of individual bonds and therefore require many synthetic steps. In contrast to such multistep processes, one-pot transformations based on multicomponent reactions (MCRs) have gained great importance in modern organic synthesis. The focal theme of this thesis is the exploration of new multicomponent reactions based on the addition of zwitterions to electrophilic systems. In order to put things in perspective, a brief introduction to MCRs and their applications in organic synthesis is given in the following section. This is followed by a brief introduction to the chemistry of zwitterions.

1.2 Multicomponent Reactions

Reactions in which three or more compounds react in one-pot to afford a product which retains all or most of the atoms of the starting materials are called multicomponent reactions (MCRs).¹ The reactants (also called educts) can be different molecules or different functional groups in a single compound. MCRs have attracted the attention of synthetic organic chemists due to their speed, efficiency, ease of execution, atom economy and environmental amiability. MCRs, being convergent reactions, offer considerable process time reduction and better yields, compared to the classical approaches that are linear or divergent. The number of possible products from an MCR increases exponentially with the multiplicity of the reaction. Due to all these advantages, MCRs have become very popular in all areas of organic chemistry.

The history of MCRs can be traced back to the work of Laurent and Gerhardt, who in 1838, from the reaction of bitter almond oil and ammonia, isolated a poorly soluble product which they called "benzoyl azotid".² In this reaction the cyanohydrin, derived from benzaldehyde **1** and hydrocyanic acid, reacts with ammonia giving amino

benzyl cyanide **2** whose Schiff base with benzaldehyde was called "benzoyl azotid" **3** (Scheme 1).

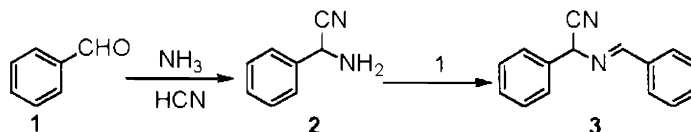

Scheme 1

The Strecker α -amino acid synthesis, reported in 1850, is another important MCR that involves the three-component condensation of ammonia, aldehyde and hydrogen cyanide to afford α -amino nitrile, which on subsequent hydrolysis furnishes the α -amino acid. An illustrative example is given in scheme 2.³

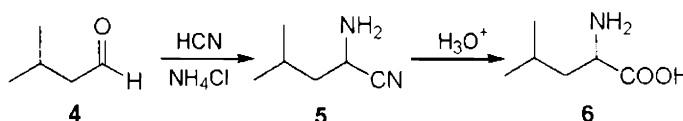

Scheme 2

The Strecker reaction has been employed on an industrial scale for the synthesis of racemic α -amino acids. The first efficient three-component asymmetric version of the Strecker reaction was developed by Kobayashi and co-workers by employing a chiral zirconium binuclear catalyst (Scheme 3).^{4, 5}

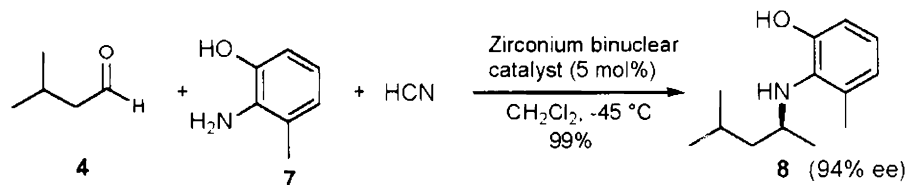

Scheme 3

Synthesis of 1,4-dihydropyridines by the reaction of ammonia, aldehyde and acetoacetic ester, reported by Hantzsch in 1882 is another example of a historically relevant MCR.⁶ This methodology has been applied to the synthesis of Nifedipin[®] **12**, an important drug used in cardiovascular therapy (Scheme 4).⁷

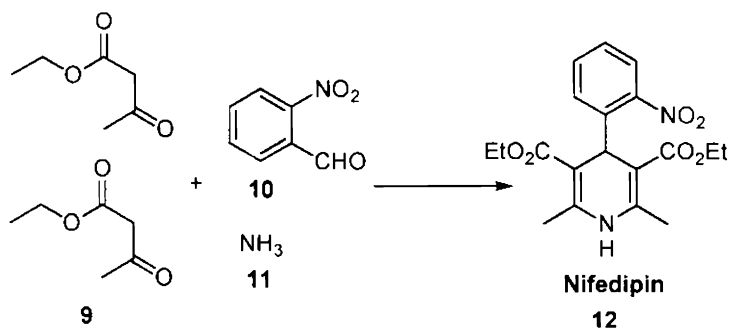

Scheme 4

The acid catalyzed three-component condensation of aldehydes, β -ketoesters and urea to afford dihydropyrimidines was reported by Biginelli in 1891 (Scheme 5).⁸

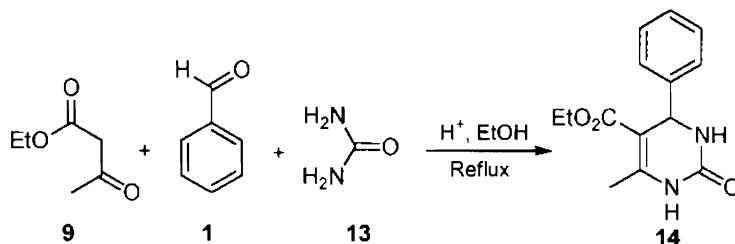

Scheme 5

The scope of the Biginelli reaction has been extended considerably by variation of all building blocks, allowing access to a large number of multifunctionalized pyrimidine derivatives with important biological properties.⁹

The one-pot synthesis of aminomethylated carbonyl compounds from formaldehyde, secondary amine and ketones is a commonly used and important MCR discovered by Mannich in 1912 (Scheme 6).¹⁰

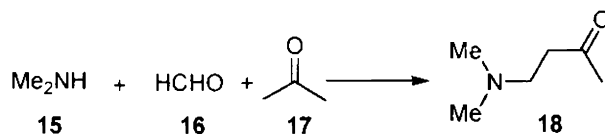

Scheme 6

Mannich type reactions have proved to be extremely valuable in the total synthesis of many natural products.¹¹ It is noteworthy that Robinson's landmark synthesis of tropinone **22** (precursor for the alkaloid tropine) involves two successive

Mannich reactions and provides a spectacular application of MCRs in natural product synthesis (Scheme 7).¹²

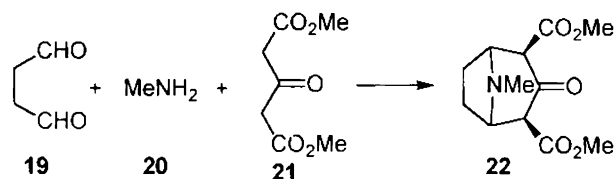

Scheme 7

A large and important class of MCRs is based on the chemistry of isocyanide (IMCRs), most important of these are the Passerini three-component reaction (P-3CR) and the Ugi four-component reaction (U-4CR). The great potential of isocyanides for the development of MCRs lies in the diversity of bond forming processes available, their functional group tolerance and the high levels of chemo-, regio- and stereoselectivity often observed. Because of these advantages, IMCRs have wide spread applications in a variety of areas in science and technology.¹³ The following passages give a brief introduction to isocyanide based multicomponent reactions.

1.2.1 The Passerini reaction (1921)

In his seminal work in 1921, Passerini discovered the three-component reaction (P-3CR) of electrophilic ketones or aldehydes with isocyanides and carboxylic acids leading to α -acyloxy amides. An illustrative example is given below (Scheme 8).¹⁴

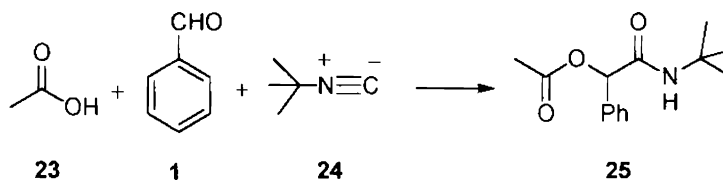

Scheme 8

A plausible mechanism, suggested by Passerini himself which agrees with the experimental observations is given in scheme 9.

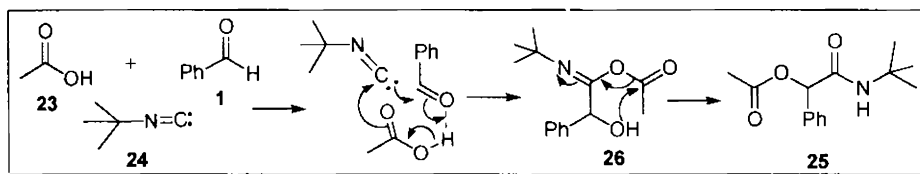

Scheme 9

The pharmacologically important depsipeptides contain the α -acyloxycarboxamide group. Thus P-3CR is suitable for the synthesis of many compounds of this class and their derivatives.¹⁵ Bifunctional starting materials such as 27 with a ketone or an aldehyde function and a carboxyl group react with the isocyanide 28 in a P-3CR to afford lactones of various ring sizes such as 29, depending on the carbonyl-carboxylic acid distance (Scheme 10).¹⁶

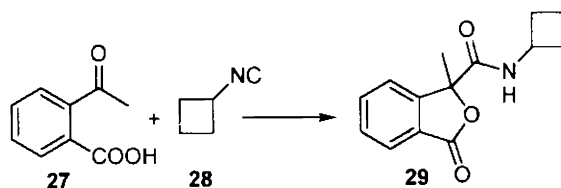

Scheme 10

Oxazoles such as 33 were generated very elegantly and with high diversity from α -oxoaldehyde 30, carboxylic acid 31 and isocyanide 32. The intermediate carboxamide product reacts smoothly with ammonium formate in acetic acid under reflux leading to the 2,4,5-trisubstituted oxazoles (Scheme 11).¹⁷ All three positions of the oxazole can be varied independently in this two step sequence.

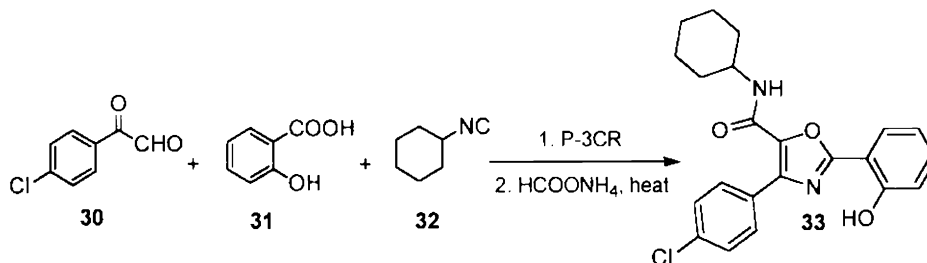

Scheme 11

1.2.1.1 Asymmetric Passerini reactions

As the rate-determining step of the Passerini reaction involves all the three components, in principle, asymmetric induction may be achieved when at least one of them is chiral. Another way to achieve asymmetric induction in P-3CR is by the use of a chiral catalyst such as a Lewis acid. The first example of an asymmetric P-3CR between three achiral components is given in scheme 12. The reaction utilizes the Lewis acid/ligand couple **37** (Scheme 12).¹⁸

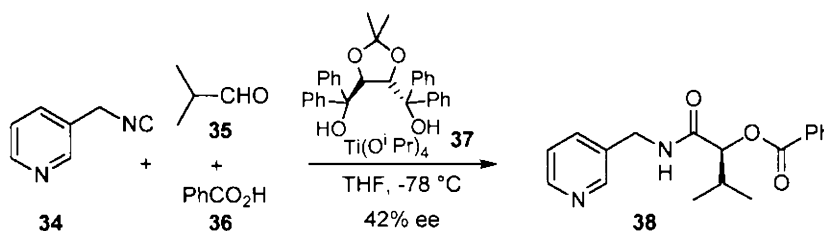

Scheme 12

1.2.2 The Ugi reaction (1959)

In 1959 Ugi showed that by exposing amines to carbonyl compounds, isocyanides and acids, high yields of α -aminocarboxamide derivatives were obtained (Scheme 13).¹⁹

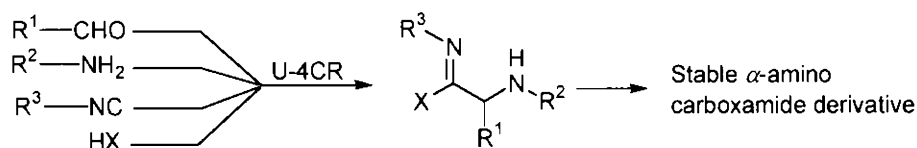

Scheme 13

Mechanistic rationale for the formation of the products can be outlined as in scheme 14. The acid component protonates the nitrogen atom of the Schiff base, formed from the aldehyde and amine. This electrophilic iminium ion and the nucleophilic acid anion add to the isocyanide carbon atom, to form the α -adduct **40**. The latter can be seen as a heteroanalogue of an acid anhydride. Anhydrides are strong acylating agents and so are their heteroanalogues. After the intramolecular acylation²⁰ of the amine, the stable Ugi product **41** is obtained.

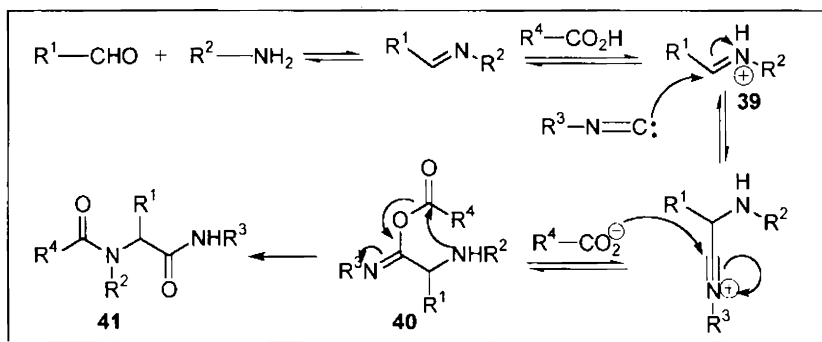

Scheme 14

All elementary steps of the Ugi reaction sequence are in equilibria, with the exception of the last step. When examined carefully, the Ugi reaction is formally a combination of Mannich and Passerini reactions. Its versatility is attributed to the wide variations possible in the reactants and the possibility of different rearrangement reactions. Any known type of C-isocyanide²¹ can be used as the isocyanide component and the only restriction for the acid component is that it must be able to rearrange irreversibly from the intermediate α -adduct of the isocyanide to deliver a stable product. Except for sterically hindered ketones, most aldehydes and ketones can generally be used as the carbonyl component. Primary or secondary amines, hydrazines and hydroxylamines can act as the amine component. The U-4CR and related reactions are used extensively in the synthesis of peptides and β -lactam derivatives.^{22, 23}

Unnatural amino acids like 4-aminobenzoic acid **42** can react with aldehydes and isocyanides in methanol, as illustrated, to afford N-(carbamoylmethyl) amino benzoic acid esters (Scheme 15).²⁴

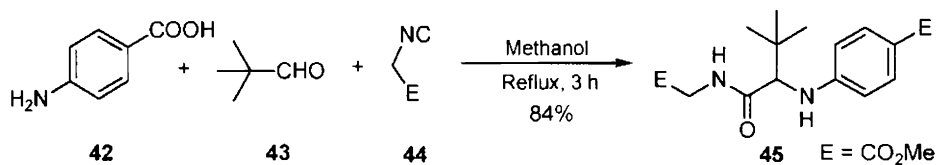

Scheme 15

1.2.2.1 Asymmetric Ugi reaction

Ugi, by theoretical considerations and experimental observations, found that induction of a new stereocentre in Ugi-4CR could be best achieved by using a chiral amine. “Perfect” chiral amines, giving high de’s and chemical yields, and can be easily cleaved under mild conditions to yield amino acid or peptide derivatives, are 1-phenylethyl amines **46**,²⁵ α -amino ferrocenyl amines **47**²⁶ and glycosyl amines **48**²⁷ (Figure 1).

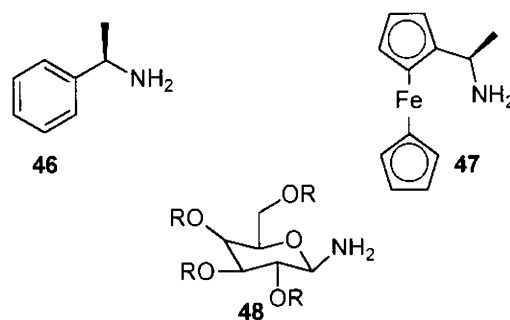
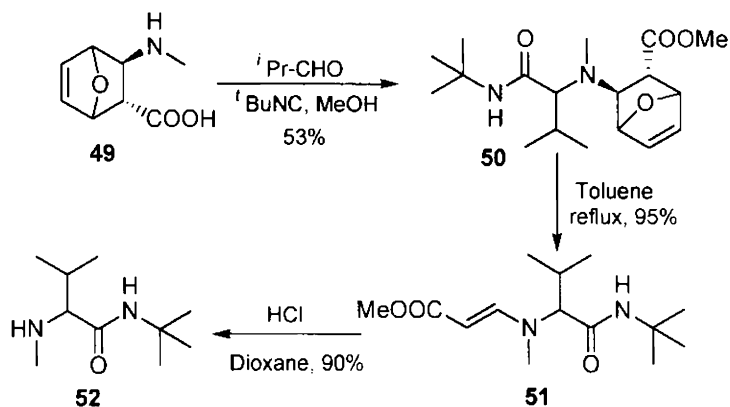

Figure 1

Excellent result in terms of stereoselectivity has been obtained in the case of N-methyl-3-exo-amino-7-oxabicyclo[2.2.1]-2-endo-carboxylic acid **49**. The single diastereomer **50** obtained, when subjected to retro Diels-Alder reaction, yielded **51** which on hydrolysis gave the N-methyl amino acid derivative **52** (Scheme 16).¹³ These results proved that certain bicyclic β -amino acids, in their optically active form, could be efficiently used as chiral auxiliaries in the stereoselective synthesis of α -amino carboxamides *via* U-MCRs.



Scheme 16

1.2.3 Other isocyanide based MCRs

Most of the isocyanide based multicomponent reactions are centered on the classical reactions of Ugi and Passerini. Motherwell *et al.* proposed a new MCR of isocyanides, carboxylic acids and epoxides yielding β -hydroxyacylamides. The products obtained are homo-Ugi but normal Passerini products (Scheme 17).^{28, 29}

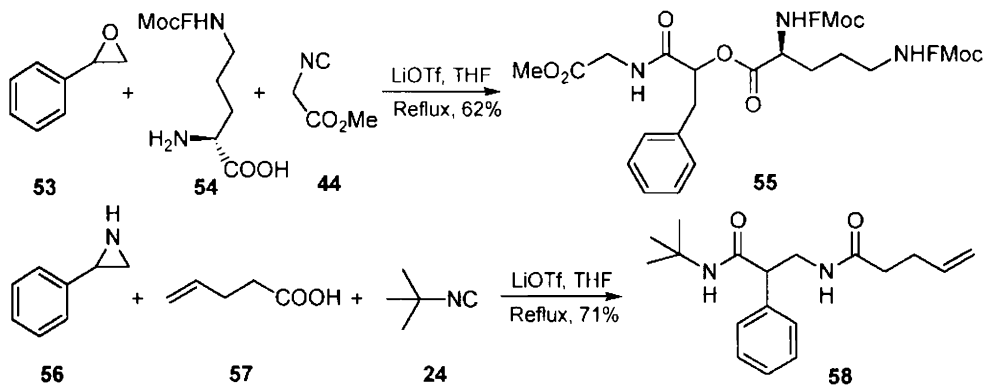

Scheme 17

The simultaneous assembly of the β -lactam and the thiazole moiety by a new MCR was described by Dömling *et al.*³⁰ The scheme below shows the reaction of 3-dimethylamino-2-isocyanoacrylate **59** with isobutyric aldehyde **35** and β -aminothiocarboxylic acid **60**. The increase in molecular complexity during this reaction is clear in the generation of 2 C-N, 2 C-S and 1 C-C bonds in a single step (Scheme 18).

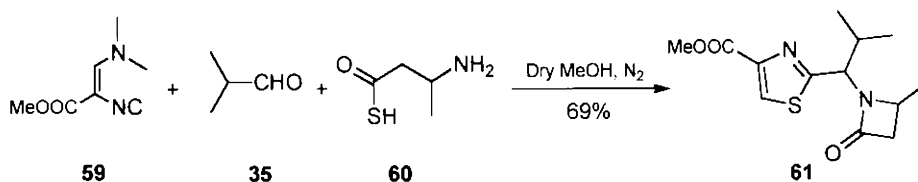

Scheme 18

A conceptual advance in designing novel MCRs is the union of two MCRs introduced by Ugi.³¹ An example of this strategy involves the union of a U-5CR-4CR with a P-3CR. Glutamic acid reacts with one equivalent of aldehyde and isocyanide in methanol to form the Ugi product, which in a second step reacts directly with the remaining carboxylic acid functionality and one equivalent of isocyanide and aldehyde to yield the Passerini product (Scheme 19).³²

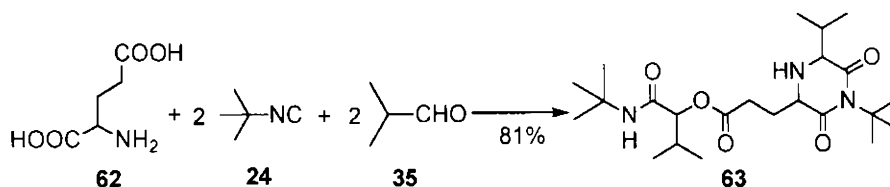

Scheme 19

Scientists at the Merck company modified the original synthesis of the anti HIV drug crixivan **67** by incorporating a Ugi-4CR, thus making the synthesis shorter, easier and better yielding (Scheme 20).³³

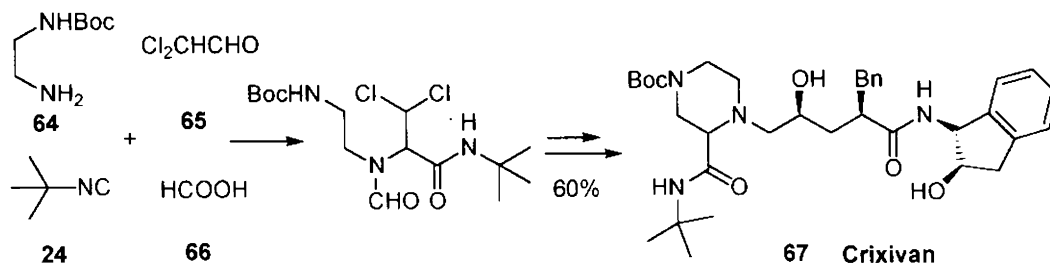

Scheme 20

1.2.4 Non-Ugi type IMCRs

Winterfeldt had shown that isocyanides react with activated acetylenic compounds to generate 1:1 zwitterionic intermediates. Recent work in our laboratory

has shown that these intermediates can react with electrophilic carbon-carbon and carbon-heteroatom bonds to generate a variety of carbocycles and heterocycles, in effect, paving the way for the development of a new class of IMCRs. The details of these reactions are discussed in chapter 4, section 4.2 of this thesis.

1.2.5 Other multicomponent transformations

Apart from the isocyanide based MCRs, design and execution of newer MCRs is a rapidly growing area of research. In the past decade, research in academia and industry has increasingly emphasized the use of MCRs for the synthesis of a broad range of products.³⁴ The one-pot reaction of isatin with α -amino acid and chalcone resulted in the formation of the spiropyrrolidine **71** as shown below (Scheme 21).³⁵

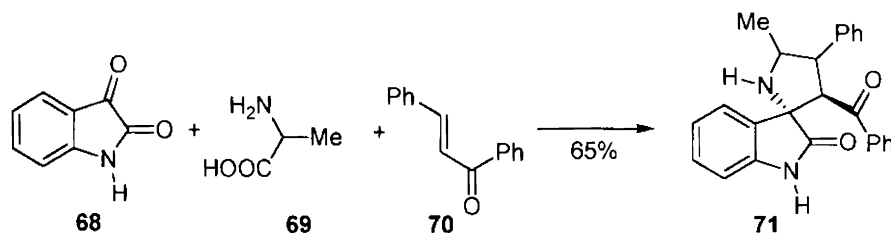

Scheme 21

Very recently the three-component coupling reaction of isocyanates, aldehydes and dienophiles leading to the endo-selective formation of amino-substituted cyclohexenes in good yields was reported. The underlying mechanism takes advantage of an initial condensation between the isocyanate **72** and aldehyde **73** to yield carbamoyl-substituted 1,3-butadiene which on subsequent decarboxylation followed by Diels-Alder reaction with electron-deficient dienophile **74** yields the cyclohexene **75** (Scheme 22).³⁶

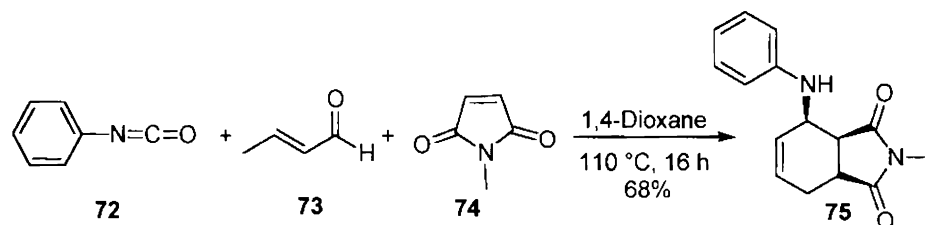

Scheme 22

Another recent example is the synthesis of polysubstituted benzenes by the thermal reaction of cyclopropane acetal **76** and dimethyl acetylenedicarboxylate **77**. The reaction takes place by a [3+2] cycloaddition, Diels-Alder reaction, and cheletropic exclusion of dialkoxycarbene resulting in the one-pot preparation of polysubstituted benzene (Scheme 23).³⁷

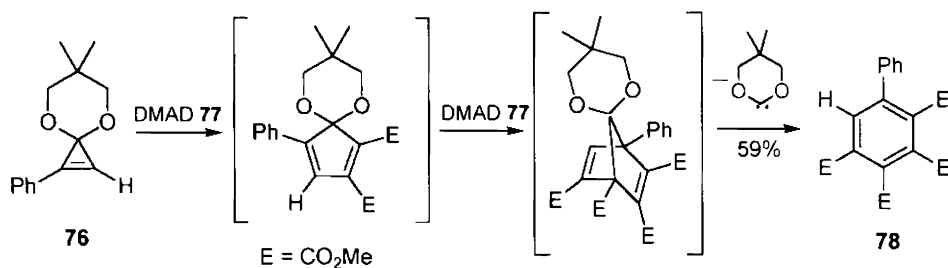

Scheme 23

Metal catalyzed multicomponent process is another rapidly developing field in MCR chemistry. One of the earliest examples of the palladium catalyzed multicomponent tetrahydrofuran synthesis is given in scheme 24. A cascade of Michael addition and olefin nucleophile carbo-functionalization catalyzed by palladium gives rise to substituted tetrahydrofurans (Scheme 24).³⁸

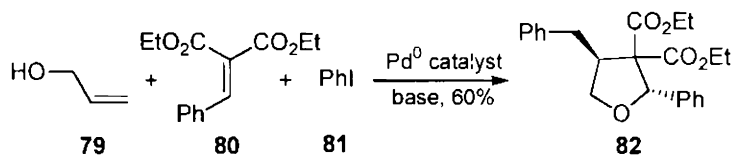

Scheme 24

1.2.6 Free radical mediated MCRs

Free radical mediated reaction is a powerful method for connecting three or more components into one molecule. The three component coupling reaction of azobisisobutyronitrile (AIBN), phenyl acetylene and *p*-methoxyphenyl isonitrile proceeds to give a quinoxaline derivative as shown below (Scheme 25).³⁹

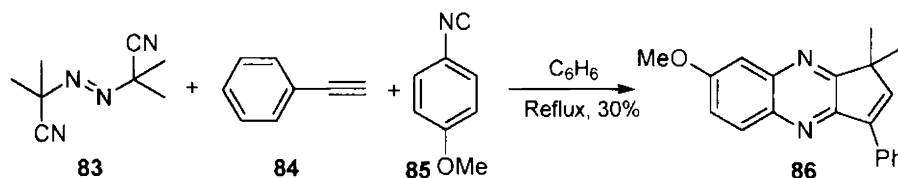

Scheme 25

An example of a three-component coupling reaction involving alkynes, electron-deficient alkenes and electron-rich alkenes giving rise to six-membered ring compounds is given in scheme 26. Oxidative aromatization by DDQ can be used to convert the product to the corresponding trisubstituted benzene **90** (Scheme 26).⁴⁰

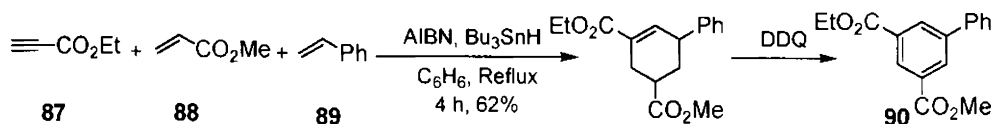

Scheme 26

The development of novel MCRs is an intellectually challenging task since one has to consider the reactivity match of the starting materials and the reactivities of the intermediates formed *in situ*.

Apart from the conventional multicomponent reactions discussed so far, work in our laboratory has shown that, a new strategy based on the reactivity of unconventional dipoles *viz.* zwitterions towards electrophiles provides a promising methodology for the development of novel multicomponent reactions.⁴¹ Huisgen and co-workers in the early 1960s had developed different type of 1,3-dipoles and paved the way for the general concept of 1,3-dipolar cycloaddition.⁴² Over the years, this reaction has developed into an extremely powerful and general method for the construction of five-membered heterocycles.⁴³ Compounds with C-C and C-N double and triple bonds as well as many different carbonyl functions are known to react with over 18 different types of 1,3-dipoles. Conceptually, apart from the conventional dipoles, zwitterionic intermediates constitute another class of reactive species that can react with various dipolarophiles to afford heterocyclic compounds. A concise historical account of such reactions is presented in the following sections.

1.3 Zwitterions

Compounds having formal electrical charges of opposite sign on non-adjacent atoms are called zwitterions. These are formed by the nucleophilic addition of donors to carbon-carbon triple bonds, which lack labile hydrogen atoms but instead are activated by acceptor groups (Figure 2). Their stabilization is achieved either by rearrangement or by cyclization or addition.⁴⁴

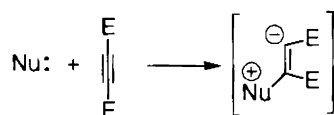

Nu = TPP, RNC, N-heterocycles, DMSO *etc.*
E = CO₂Me, SO₂R, CN, COR *etc.*

Figure 2

1.3.1 Addition of pyridine

As early as 1932, Diels and Alder showed that pyridine reacts smoothly with dimethyl acetylenedicarboxylate to form 1:2 adduct **93** (Scheme 27).⁴⁵ Extensive investigations by Acheson and co-workers established the structure of the adduct as **94**, formed by the addition of a second molecule DMAD to the 1,4-dipole **92** followed by a [1,5] H-shift in the initial product **93** as illustrated in scheme 27.⁴⁶

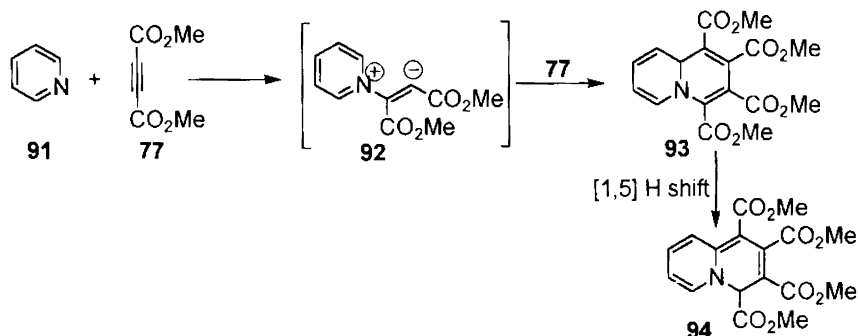

Scheme 27

The existence of the 1,4-dipole was further confirmed by its interception with carbon dioxide (Scheme 28).⁴⁷

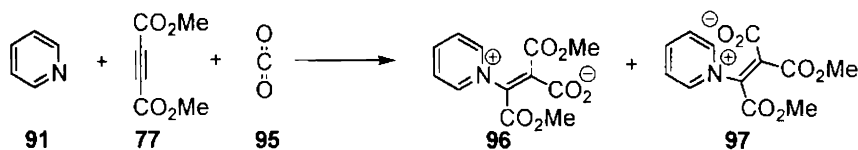

Scheme 28

Winterfeldt showed that intramolecular cyclization of the 1,4-dipole to a carbonyl group can be achieved in the case of ethylpyridylacetate to give 2H-quinolizone **99** as the major product in polar solvents and 4H-quinolizone **100** in non-polar solvents (Scheme 29).⁴⁸

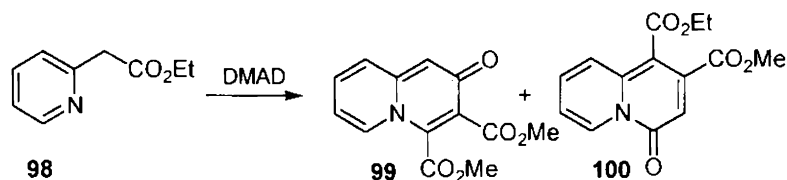

Scheme 29

It was Huisgen who introduced the concept of 1,4-dipolar cycloaddition and classified many reactions in this category. The reaction of pyridine and DMAD in methanol, afforded the products **102** and **103** as shown below (Scheme 30).⁴⁹

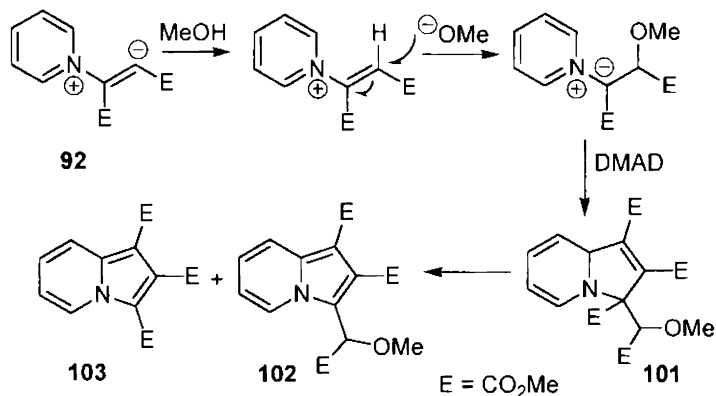

Scheme 30

Acheson showed that intramolecular cyclization of the 1,4-dipole to an olefinic bond resulted in the direct synthesis of 2H-quinolizines.⁵⁰

Recent work in our laboratory has shown that 1,4 dipole generated from pyridine and DMAD can be intercepted with aldehydes, N-tosylimines and activated styrenes

leading to benzoyl fumarates, aza-dienes and 1,3-butadienes respectively (Scheme 31).⁵¹

It is noteworthy that pyridine is required only in catalytic amounts in these reactions.

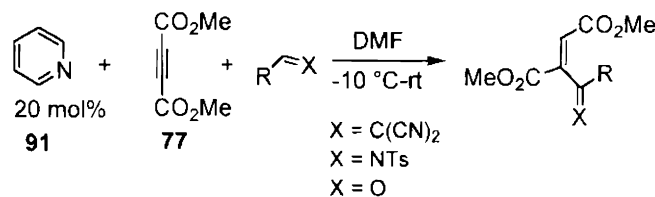

Scheme 31

Very recent work of the group has also shown that the pyridine-DMAD zwitterion can react with 1,2-dicarbonyl compounds like benzils and cyclobutenediones to deliver diaroyl maleates and hexa-substituted benzene derivatives respectively as shown below (Scheme 32).⁵²

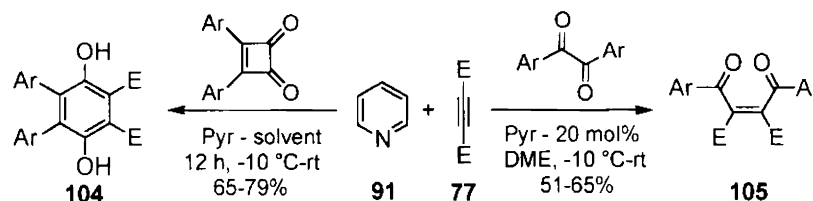

Scheme 32

1.3.2 Addition of isoquinoline

As early as 1967 Huisgen *et al.* have shown that isoquinoline and DMAD react with various dipolarophiles by 1,4-dipolar cycloaddition leading to condensed isoquinoline derivatives as shown in scheme 33.⁵³

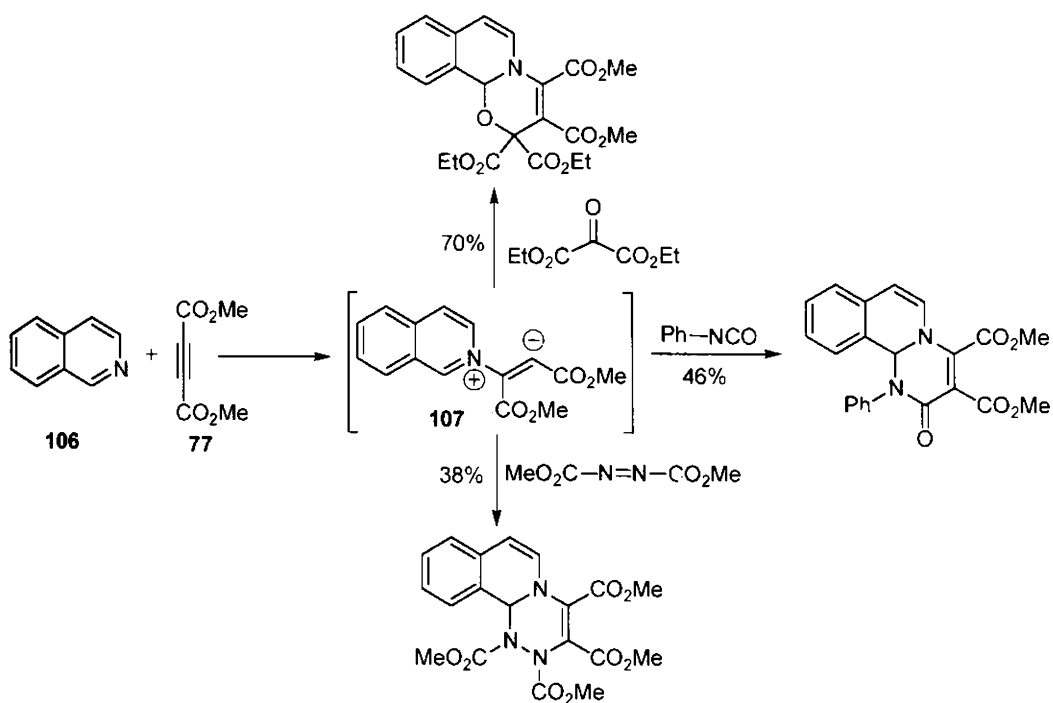

Scheme 33

Work in our laboratory has shown that the isoquinoline-DMAD zwitterion can be intercepted by aldehydes, N-tosylimines, 1,2- and 1,4- quinones and activated styrenes, thus constituting novel MCRs leading to the synthesis of isoquinoline fused heterocycles.⁵⁴ An illustrative example is shown in scheme 34.

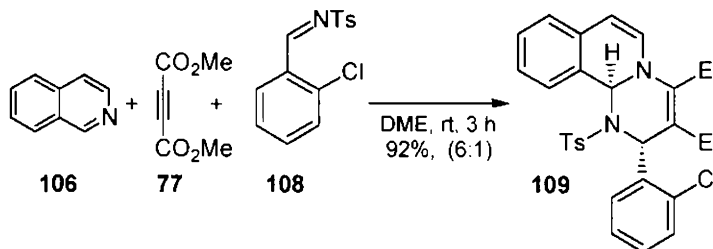

Scheme 34

1.3.3 Addition of imines

Huisgen and Herbig have used imines as donors in the reaction with DMAD leading to the dihydropyridine derivative **111** (Scheme 35).⁵⁵

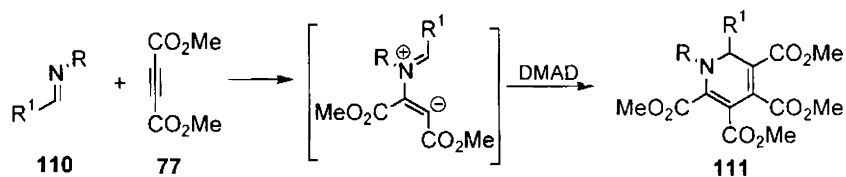

Scheme 35

The 1,4-dipole formed can also be intercepted with excess imine. For example, excess of dihydroisoquinoline **112** reacts with DMAD to form the pentacyclic compound **113** as shown in scheme 36.⁵⁶

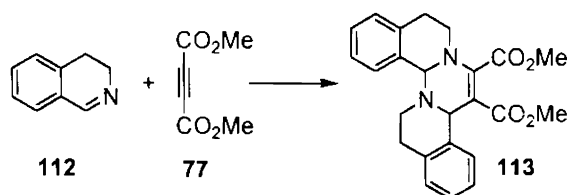

Scheme 36

1.3.4 Addition of enamines

The reaction of enamines with activated triple bonds was studied by several research groups.⁵⁷ The reaction proceeds *via* a four-membered ring adduct **115**, which undergoes ring cleavage to form the dienamine **116** (Scheme 37).

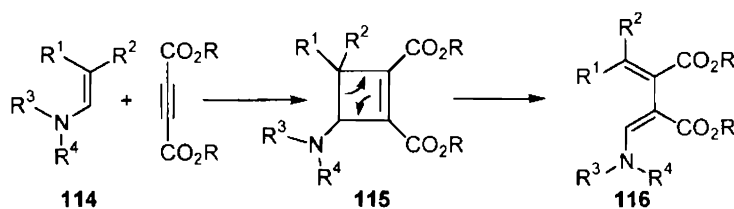

Scheme 37

Cyclic enamines undergo ring expansion *via* a similar intermediate affording ring enlarged products (Scheme 38).⁵⁸

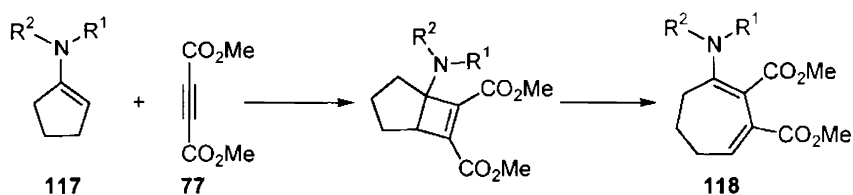

Scheme 38

1.3.5 Addition of sulphur compounds

Winterfeldt has shown that dimethyl sulfoxide reacts with excess of DMAD to yield the furan derivative **122** as shown in scheme 39.⁵⁹

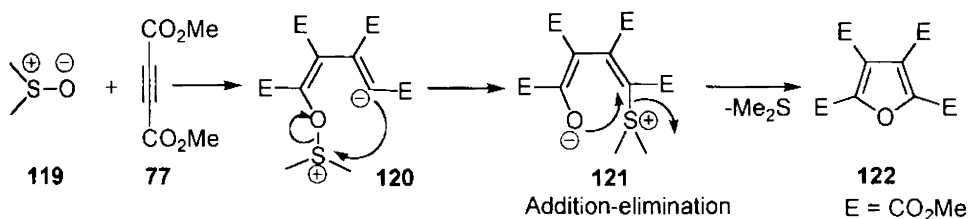

Scheme 39

1.3.6 Addition of phosphorus compounds

Johnson and Tebby have shown that triarylphosphines react with DMAD to form a series of adducts of differing stoichiometry. The initial event is the formation of the 1,3-dipole **123** which can be represented by a carbene structure **124** also. In presence of excess triphenylphosphine, the phosphorane **125** is obtained while in presence of excess DMAD, the carbene **124** dimerizes to form **126** (Scheme 40).⁶⁰

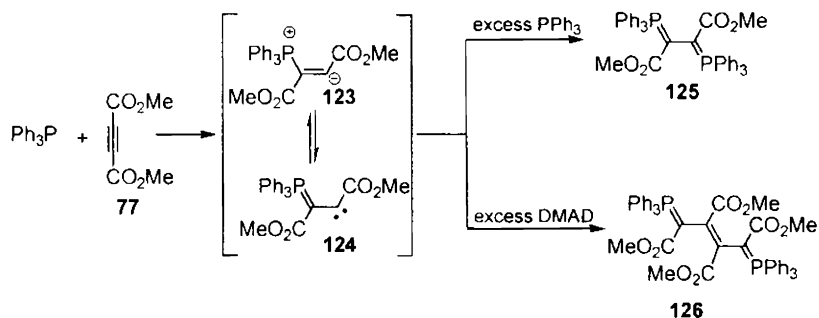

Scheme 40

Dicyanoacetylene **127** reacts with TPP to yield a stable adduct which has been shown to be a 1,6-alkylidene diphosphorane **128** (Scheme 41).⁶¹

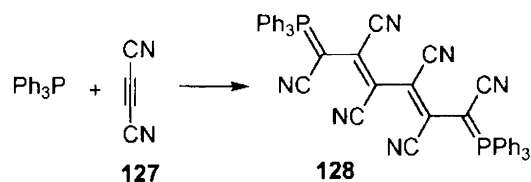

Scheme 41

In presence of a protic solvent such as water, the solvent adds to the zwitterionic species **129** to form fumaronitrile **130** and triphenylphosphine oxide (Scheme 42).⁶²

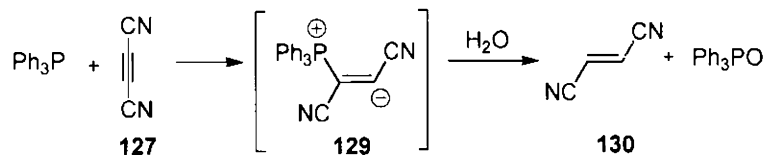

Scheme 42

Both the zwitterions **123** and **129** can react with sulphur dioxide and carbon dioxide to afford the betaines **131** and **132** respectively (Scheme 43).⁶³

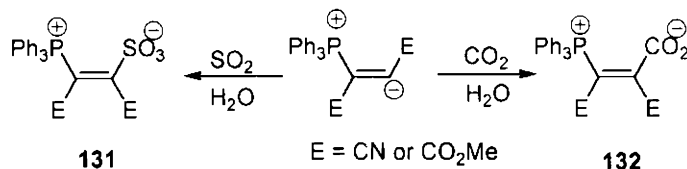

Scheme 43

A brief introduction to phosphine mediated reactions and our recent observations about the reactivity of triphenylphosphine-DMAD zwitterion towards activated styrenes are presented in chapter 2 of this thesis.

1.3.7 Addition of isocyanides

Isocyanides are known to form zwitterions with activated acetylenic compounds like dimethyl acetylenedicarboxylate (DMAD).⁶⁴ Winterfeldt and co-workers have investigated the addition of isocyanides to DMAD in detail. The highly reactive zwitterionic intermediate undergoes further reaction with isocyanide or DMAD to yield a variety of complex heterocyclic compounds. Conceptually, the intermediate can be considered as a carbanion **133**, carbene **134** or even a cyclopropene imine **135** (Scheme 44).

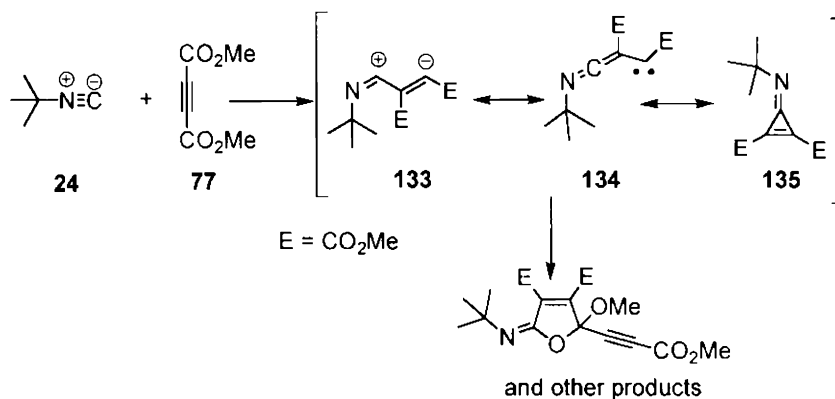

Scheme 44

A brief introduction to the chemistry of isocyanides along with a novel reactivity of isocyanide-DMAD zwitterions towards 1,2,3-tricarbonyl compounds is described in chapter 4.

1.3.8 Addition of nucleophilic carbenes

Nucleophilic carbenes are those having adjacent heteroatoms with lone-pair of electrons, which can be donated to the vacant *p*-orbital of the carbene carbon thus rendering them nucleophilic. Dialkoxycarbenes, diaminocarbenes, oxaminocarbenes, dithiocarbenes all come under this category. This π -donation imparts considerable dipolar character and stabilizes the singlet state of the carbene as shown in scheme 45.⁶⁵

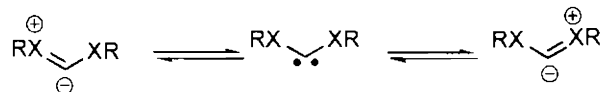

Scheme 45

Addition of such nucleophilic carbenes to activated acetylenes generates zwitterionic intermediates or all carbon 1,3-dipoles.

1.3.8.1 Dialkoxycarbenes

Hoffmann had shown that dimethoxycarbene generated by the thermolysis of norbornadiene ketal **136**,^{66a} adds to DMAD to furnish the dihydrofuran derivative **138** in

low yields.^{66b} The intermediacy of the 1,3-dipole **137** is evident from the reactivity pattern (Scheme 46).

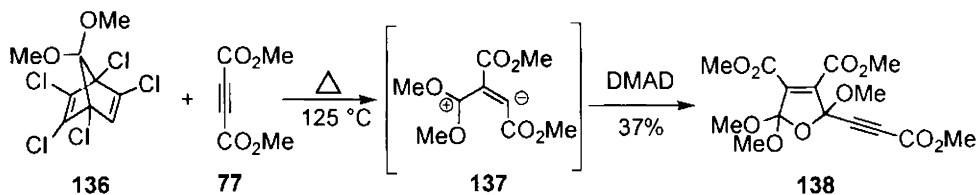

Scheme 46

A brief survey of the generation and reactivity patterns of dialkoxycarbenes and the investigations concerned with the interception of the dimethoxycarbene-DMAD zwitterion with 1,2-dicarbonyl compounds are presented in chapter 3.

1.3.8.2 N-Heterocyclic carbenes

As early as 1958, Breslow recognized the role of N-heterocyclic carbenes (NHCs) as nucleophilic catalysts in enzymatic reactions. His seminal work has shown that thiamine, as its diphosphate can catalyze the decarboxylation of pyruvic acid to active acetaldehyde as well as the benzoin condensation of aromatic aldehydes.⁶⁷ Wanzlick in 1960s recognized that the electron-rich imidazole nucleus can stabilize a carbene centre between the two nitrogens.⁶⁸ Recent isolation of stable imidazol-2-ylidene by Arduengo *et al.*⁶⁹ and the demonstration by organometallic chemists that NHCs are excellent ligands for transition metals,⁷⁰ have contributed enormously to the renewed interest in this area. NHCs have also found applications as excellent catalysts for transesterifications, nucleophilic aromatic substitutions and cycloaddition reactions.⁷¹

Recent work in our laboratory has led to the development of new MCRs based on NHCs. Imidazolin-2-ylidene **140** and imidazol-2-ylidene **142** reacted in two different ways with aldehyde and DMAD to produce the oxymaleate derivative **141** and furanone derivative **143** respectively in good yields (Scheme 47).⁷²

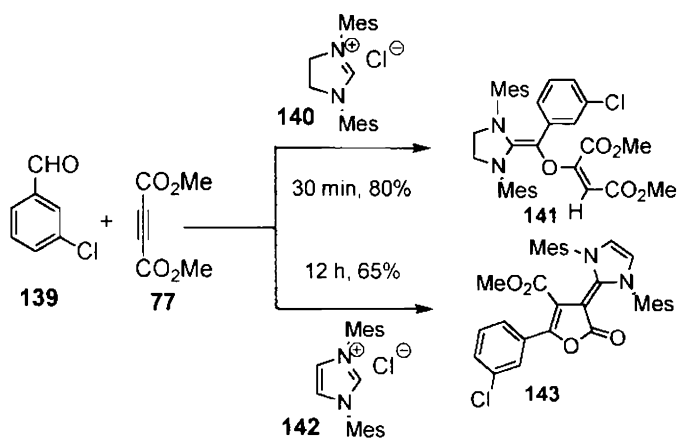

Scheme 47

1.4 Definition of the problem

Considering the immense importance of MCRs and their widespread application in organic synthesis, development of new MCRs seemed to be a promising area of research. Earlier work in our laboratory has shown that the strategy of adding zwitterions (generated by the addition of various nucleophiles like triphenylphosphine, dialkoxycarbene, isocyanide, isoquinoline *etc.* to activated acetylenic compounds like dimethyl acetylenedicarboxylate) to electrophilic C-C and C-heteroatom bonds is a very efficient method for the construction of various carbocycles and heterocycles.⁴¹

Although the reactivity of triphenylphosphine-DMAD zwitterion towards electrophilic C-N and C-O bonds is known, its reactivity towards electrophilic C-C bonds has not been explored so far. In the first part of our work we have studied the reaction of this zwitterion with activated styrenes like arylidene malononitriles and β -nitrostyrenes leading to highly substituted phosphoranes.

The reactivity of dimethoxycarbene-DMAD zwitterion towards aldehydes and *p*-quinones has been well established while their reaction to 1,2-diones has not been investigated so far. We have undertaken a detailed study of this reaction leading to dihydrofurans and spirodihydrofurans and the results are described in the third chapter of this thesis.

1,2,3-tricarbonyl compounds have not been utilized as electrophiles in MCRs till now. In the final chapter of this thesis, we describe how these can function as electrophiles in the reaction with isocyanides and DMAD leading to fully substituted furan derivatives.

1.5 References

1. Dömling, A.; Ugi, I. *Angew Chem., Int. Ed. Engl.* **2000**, *39*, 3168.
2. a) Laurent, A.; Gerhardt, C. F. *Ann. Chem. et Physique* **1838**, *66*, 181. b) Laurent A.; Gerhardt, C. F. *Liebigs Ann. Chem.* **1838**, *28*, 265.
3. Strecker, A. *Ann. Chem. Pharm.* **1850**, *75*, 27.
4. Ishitani, H.; Komiyama, S. Y.; Hasegawa, Y.; Kobayashi, S. *J. Am. Chem. Soc.* **2000**, *122*, 762.
5. For other catalytic asymmetric Strecker type reactions see: Yet, L. *Angew. Chem. Int. Ed. Engl.* **2001**, *40*, 875.
6. Hantzsch, A. *Justus Liebigs Ann. Chem.* **1882**, *215*, 1.
7. Bossert, F.; Meyer, H.; Wehinger, R. *Angew. Chem.* **1981**, *93*, 755.; *Angew. Chem., Int. Ed. Engl.* **1981**, *20*, 762.
8. Biginelli, P. *Gazz. Chim. Ital.* **1893**, *23*, 360.
9. a) Kappe, C. O. *Tetrahedron* **1993**, *49*, 6937. b) Kappe, C. O. *Acc. Chem. Re.* **2000**, *33*, 879. c) Kappe, C. O.; Stadler, A. *Org. React.* **2004**, *63*, 1.
10. Mannich, C.; Krösche, W. *Arch. Pharm.* **1912**, *250*, 647.
11. Arend, M.; Westermann, B.; Risch, N. *Angew. Chem.* **1998**, *110*, 1096.
12. Robinson, R. *J. Chem. Soc.* **1917**, *111*, 876.
13. Dömling, A. *Chem. Rev.* **2006**, *106*, 17.
14. Passerini, M. *Gazz. Chim. Ital.* **1921**, *51*, 126.
15. a) Fetzer, U.; Ugi, I. *Justus Liebigs Ann. Chem.* **1962**, *659*, 184. b) Rachon, *Chimia* **1983**, *37*, 299.
16. Passerini, M. *Gazz. Chim. Ital.* **1923**, *53*, 331.
17. Bossio, R.; Marcaccini, S.; Pepino, R. *Liebigs Ann. Chem.* **1991**, 1107.

32. Ugi, I.; Demharter, A.; Hörl, W.; Schmid, T. *Tetrahedron* **1996**, *52*, 11657.
33. Rossen, K.; Sager, J.; Di Michele, L. M. *Tetrahedron Lett.* **1997**, *38*, 3183.
34. For selected recent examples see: a) Vugts, D. J.; Jansen, H.; Schmitz, R. H.; de Kanter, F. J. J.; Orru, R. V. A. *Chem. Commun.* **2003**, 2594. b) Gamez-Montano, R.; Gonzalez-Zamora, E.; Potier, P.; Zhu, J. P. *Tetrahedron* **2002**, *58*, 6351.
35. Fokas, D.; Ryan, W. J.; Casebier, D. S.; Coffen, D. L. *Tetrahedron Lett.* **1998**, *39*, 2235.
36. Strübing, D.; Neumann, H.; Hübner, S.; Klaus, S.; Beller, M. *Org. Lett.* **2005**, *7*, 4321.
37. Sato, S.; Isobe, H.; Tanaka, J.; Ushijima, T.; Nakamura, E. *Tetrahedron* **2005**, *61*, 11449.
38. Cavicchioli, M.; Sixdenier, E.; Derrcy, A.; Bouyssi, D.; Balme, G. *Tetrahedron Lett.* **1997**, *38*, 1763.
39. Nanni, D.; Pareschi, P.; Rizzoli, C.; Sgarabotti, P.; Jundo, A. *Tetrahedron* **1995**, *51*, 9045.
40. Lu, E.; Hur, C. U.; Rhee, Y. H.; Park, Y. C.; Kim, S. Y. *J. Chem. Soc., Chem. Commun.* **1993**, 1466.
41. Nair, V.; Rajesh, C.; Vinod, A. U.; Bindu, S.; Sreekanth, A. R.; Mathen, J. S.; Balagopal, L. *Acc. Chem. Res.* **2003**, *36*, 899.
42. a) Huisgen, R. *Proc. Chem. Soc.* **1961**, 357. b) Huisgen, R. *Angew. Chem., Int. Ed. Engl.* **1967**, *6*, 163. c) Huisgen, R. In *The Adventure Playground of Mechanisms and Novel Reactions: Profiles, Pathways and Dreams*; Seeman, J. L, Ed.; American Chemical Society: Washington, DC, 1994; p 62.
43. Padwa, A. *1,3-Dipolar Cycloaddition Chemistry*; Ed.; Wiley-Interscience: New York, 1984; Vols 1 and 2.
44. a) Winterfeldt, E. *Angew. Chem., Int. Ed. Engl.* **1967**, *6*, 423. b) Winterfeldt, E. in *Newer Methods of Preparative Organic Chemistry*; Ed.; Forest, W., AP: New York, 1970; Vol VI, 243.

45. Diels, O.; Alder, K. *Liebigs Ann. Chem.* **1932**, *16*, 498.
46. Acheson, R. M. *Adv. Heterocycl. Chem.* **1963**, *1*, 125.
47. a) Crabtree, A.; Johnson, A. W.; Tebby, J. C. *J. Chem. Soc.* **1961**, 3497. b) Acheson, R. M.; Plunkett, A. O. *J. Chem. Soc.* **1964**, 2676.
48. Winterfeldt, E.; Naumann, A. *Chem. Ber.* **1965**, *98*, 3537.
49. a) Huisgen, R.; Morikawa, M.; Herbig, K.; Brunn, E. *Chem. Ber.* **1967**, *100*, 1094. b) Huisgen, R. *Ger. Z. Chem.* **1968**, *8(8)*, 290. c) Huisgen, R. *Topics in Heterocyclic Chemistry*; Castle, R., Ed.; John Wiley & Sons New York, 1969, chapter 8, 223.
50. Acheson, R. M.; Hodgson, S. J.; Wright, R. G. M. *J. Chem. Soc., Perkin Trans. 1* **1976**, 1911.
51. a) Nair, V.; Sreekanth, A. R.; Vinod, A. U. *Org. Lett.* **2001**, *3*, 3495. b) Nair, V.; Sreekanth, A. R.; Vinod, A. U. *Org. Lett.* **2002**, *4*, 2807. c) Nair, V.; Sreekanth, A. R.; Abhilash, N.; Remadevi, B.; Menon, R. S.; Rath, N. P.; Srinivas, R. *Synthesis* **2003**, 1895.
52. a) Nair, V.; Abhilash, N.; Menon, R. S.; Suresh, E. *Org. Lett.* **2005**, *7*, 1189. b) Nair, V.; Abhilash, N.; Beneesh, P. B.; Suresh, E. *Org. Lett.* **2005**, *7*, 4625.
53. Huisgen, R.; Morikawa, M.; Herbig, K.; Brunn, E. *Chem. Ber.* **1967**, *100*, 1094.
54. a) Nair, V.; Sreekanth, A. R.; Abhilash, N.; Bhadbade, M. M.; Gonnade, R. *Org. Lett.* **2002**, *4*, 3575. b) Nair, V.; Sreekanth, A. R.; Biju, A. T.; Rath, N. P. *Tetrahedron Lett.* **2002**, *43*, 729. c) Nair, V.; Rema Devi, B.; Vidya, N.; Abhilash, N.; Menon, R. S. *Tetrahedron Lett.* **2004**, *45*, 3203.
55. Huisgen, R.; Herbig, K. *Liebigs Ann. Chem.* **1965**, 688, 98.
56. Gagan, J. M. F. *J. Chem. Soc. (C)* **1966**, 2221.
57. a) Bertholdt, G. A.; Uhlig, F. *J. Org. Chem.* **1964**, *29*, 1459. b) Huebner, C. F.; Dorfman, L.; Robinson, M. M.; Donoghue, E.; Pierson, W. G.; Strachan, P. *Ibid.* **1963**, *28*, 3134. c) Bose, A. K.; Mina, G.; Manhas, M. S.; Rzucidlo, E.

- Tetrahedron Lett.* **1963**, *4*, 1467. d) Brannock, K. C.; Burpitt, G. R. D.; Goodlet, V. W.; Thweatt, J. G. *J. Org. Chem.* **1964**, *29*, 1464.
58. Froborg, J.; Magnusson, G. *J. Am. Chem. Soc.* **1978**, *100*, 6728.
59. Winterfeldt, E. *Chem. Ber.* **1965**, *98*, 1581.
60. a) Johnson, A. W.; Tebby, J. C.; Griffiths, D. V. *J. Chem. Soc.* **1961**, 2126. b) Tebby, J. C.; Wilson, I. F.; Griffiths, D. V. *J. Chem. Soc., Perkin Trans 1* **1979**, 2133.
61. Shaw, M. A.; Tebby, J. C.; Ward, R. S.; Williams, D. H. *J. Chem. Soc.* **1970**, 504.
62. Butterfield, P. J.; Tebby, J. C.; Griffiths, D. V. *J. Chem. Soc., Perkin Trans. 1* **1979**, 1189.
63. a) Shaw, M. A.; Tebby, J. C.; Ward, R. S.; Williams, D. H. *J. Chem. Soc.* (C) **1968**, 2795. b) Shaw, M. A.; Tebby, J. C.; Ronayne, J.; Williams, D. H. *J. Chem. Soc. (C)* **1967**, 944.
64. a) Winterfeldt, E.; Schumann, D.; Dillinger, H. *J. Chem. Ber.* **1969**, *102*, 1656. b) Dillinger, H. J.; Fengler, G.; Schumann, D.; Winterfeldt, E. *Tetrahedron* **1974**, *30*, 2553. c) Dillinger, H. J.; Fengler, G.; Schumann, D.; Winterfeldt, E. *Ibid.* **1974**, *30*, 2561. d) Junjappa, H.; Saxena, M. K.; Ramaiah, D.; Loharay, B. B.; Rath, N. P.; George, M. V. *J. Org. Chem.* **1998**, *63*, 9801.
65. a) Moss, R. A. *Acc. Chem. Res.* **1989**, *22*, 15. b) Rondan, N. G.; Houk, K. N.; Moss, R. A. *J. Am. Chem. Soc.* **1980**, *102*, 1770. c) Pole, D. L.; Sharma, P. K.; Warkentin, J. *Can. J. Chem.* **1996**, *74*, 1335.
66. a) Hoffmann, R. W. *Angew. Chem., Int. Ed. Engl.* **1971**, *10*, 529. b) Hoffmann, R. W.; Lilienblum, W.; Dittrich, B. *Chem. Ber.* **1974**, *107*, 3395.
67. Breslow, R. *J. Am. Chem. Soc.* **1958**, *80*, 3719.
68. a) Wanzlick, H. -W. *Angew. Chem.* **1962**, *1*, 75. b) Wanzlick, H. -W.; Schönherr, H. -J. *Liebigs Ann. Chem.* **1970**, *731*, 176.

69. Arduengo, A. J.; Kline, M.; Calabrese, J. C.; Davidson, F. *J. Am. Chem. Soc.* **1991**, *113*, 9704.
70. Fürstner, A.; Ackermann, L.; Gabor, B.; Goddard, R.; Lehmann, C. W.; Mynott, F.; Stelzer, F.; Thiel, O. R. *Chem. Eur. J.* **2001**, *7*, 3236.
71. a) Davis, J. H. Jr.; Forrester, K. *Tetrahedron Lett.* **1999**, *40*, 1621. b) Enders, D.; Kallafass, U. *Angew. Chem., Int. Ed. Engl.* **2002**, *41*, 1743. c) Kerr, M. S.; de Alaniz, J. R.; Rovis, T. *J. Am. Chem. Soc.* **2002**, *124*, 10298.
72. Nair, V.; Bindu, S.; Sreekumar, V.; Rath, N. P. *Org. Lett.* **2003**, *5*, 665.

The Reaction of Triphenylphosphine-DMAD Zwitterion with Activated Styrenes - Synthesis of Highly Substituted Phosphoranes

2.1 Introduction

With the advent of Wittig's olefination and its subsequent modifications, organophosphorus compounds have received great attention in synthetic organic chemistry.¹ The common applications include the use of phosphonium ylides in Wittig reaction, the use of phosphines in the Staudinger and Mitsunobu reactions and the use of phosphines as ligands in transition metal mediated processes.² Triphenylphosphine (TPP) and its derivatives have been generally used due to their low cost and air-stability, but where greater nucleophilicity is required, the more air-sensitive trialkylphosphines takes the lead role. The chemistry of phosphines is centered on the non-bonded lone-pair of electrons on phosphorus atom. Phosphines are known to bring about transformations both catalytically and stoichiometrically. In this chapter, a novel MCR of triphenylphosphine, DMAD and electron-deficient styrenes is presented. Before discussing the results, a brief overview of phosphine mediated reactions is presented in the following sections.

2.2 Phosphines as catalysts

Phosphines are widely used as nucleophilic catalysts to bring about various transformations. Before 1990s, phosphines behaving as nucleophilic catalysts were reported only sporadically. However, the last decade has seen a considerable upsurge of interest in phosphine catalysis. This section gives an outline of the various reactions in which phosphine plays a catalytic role.

A historically relevant reaction based on phosphine catalysis is the Rauhut-Currier reaction, which describes the phosphine catalyzed dimerization of activated alkenes.^{3a} When two different alkenes are employed in the reaction, cross-coupled product is obtained in major amounts.^{3b} Illustrative examples are shown below (Scheme 1).

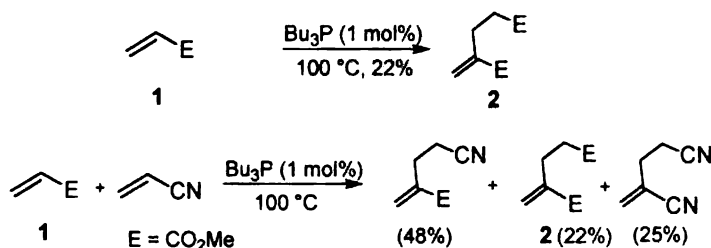

Scheme 1

The Rauhut-Currier reaction received only scant attention for many years, until when the Rousch's reported several intramolecular versions of the reaction leading to various indacene ring systems.⁴ An example of the intramolecular process in which the activated alkenes are tethered by a carbon chain is given in scheme 2. Symmetrical bis(enones) such as **3** cyclized efficiently in the presence of phosphine while the unsymmetrical bis(enones) underwent chemoselective addition of the more electrophilic alkene onto the less electrophilic alkene (Scheme 2).⁵

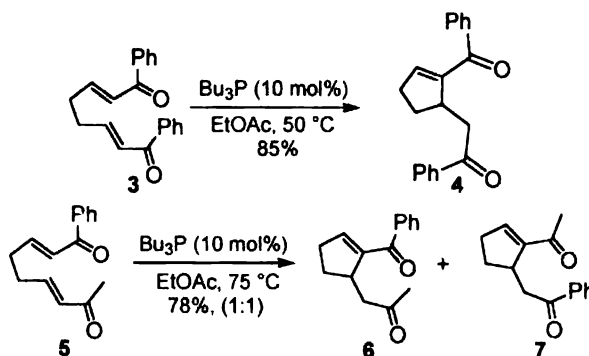

Scheme 2

Another reaction in which phosphine plays the role of a catalyst is the Morita-Baylis-Hillman reaction (MBH). Morita and co-workers, in 1968 employed tricyclohexylphosphine as the nucleophilic catalyst for the coupling of an activated alkene and aldehyde (Scheme 3).⁶

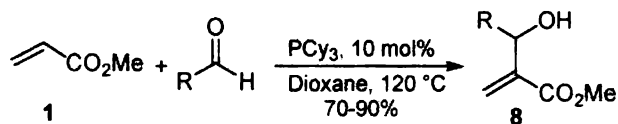

Scheme 3

Baylis and Hillman in 1972 used tertiary amines such as DABCO for the same reaction.⁷ Since then research on tertiary amine catalyzed MBH reactions escalated rapidly.⁸ Intramolecular MBH reactions using trialkylphosphines were reported by Frater and much later by Murphy and Keck.⁹ There are also many reports where chiral phosphine catalysts are used to bring about asymmetric MBH reactions.⁴ Phosphine catalysts were also found to be efficient in the aza-MBH reactions where an imine replaces the aldehyde. Later on several chiral phosphines were employed to afford the aza-MBH products in moderate enantiomeric excess.¹⁰

Phosphines are also known to catalyze Michael reactions of activated alkenes and alkynes. Recently Toste and Bergman reported a phosphine catalyzed Michael addition of alcohols and water to activated alkenes (Scheme 4).¹¹

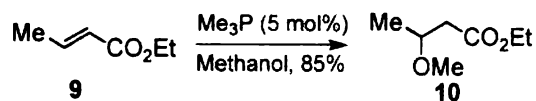

Scheme 4

The early 90s witnessed a lot of activity in phosphine catalysis centered on the isomerization and nucleophilic addition reactions of alkynoates and allenoates. A convenient synthesis of (*E,E*)-diene carbonyl compounds could be achieved by the isomerization of the corresponding acetylenic derivatives with phosphine complexed transition metal species acting as the catalyst.¹² Further investigations proved that the isomerizations took place in presence of phosphine alone without the transition metal, with alcohol acting as the co-catalyst (Scheme 5). Isomerization reactions catalyzed by phosphine provides a practical method for the synthesis of useful polyenyl carbonyl compounds.¹³

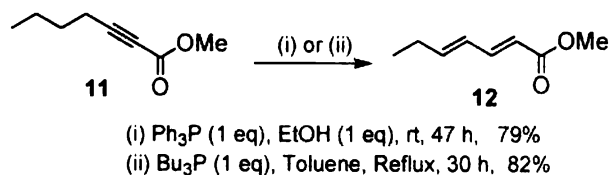

Scheme 5

Trost reported the phosphine catalyzed γ -addition of nucleophiles to 2-alkynoates leading to the formation of adducts such as **15** (Scheme 6).¹⁴

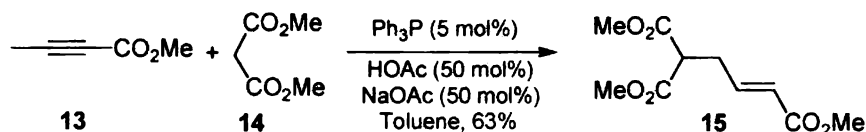

Scheme 6

Zhang and Lu proved that electron-deficient alkynes are synthetically equivalent to electron-deficient allenes in the phosphine-catalyzed γ -addition of nucleophiles. Treatment of ethyl 2,3-butadienoate **16** with dimethyl malonate **14** in presence of 5 mol% TPP in benzene at room temperature gave the adduct **17** in 65% isolated yield (Scheme 7).^{15,16}

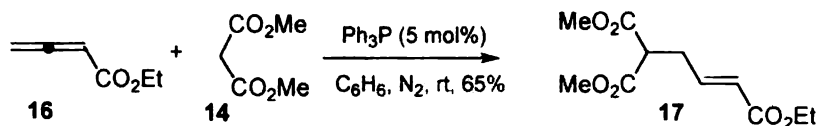

Scheme 7

Since then the reactivity of the 1,3-dipole formed from electron-deficient allenoates such as alkyl 2,3-butadienoate and phosphine has been a subject of detailed investigations.¹⁷ The dipole formed from the allenoate **16** and trialkylphosphine can exist in two resonance forms as shown in the scheme below. The [3+2] cycloadditions of these species to electron-deficient olefins and tosylimines led to the formation of cyclopentenes and pyrrolidines respectively (Scheme 8).^{16,18}

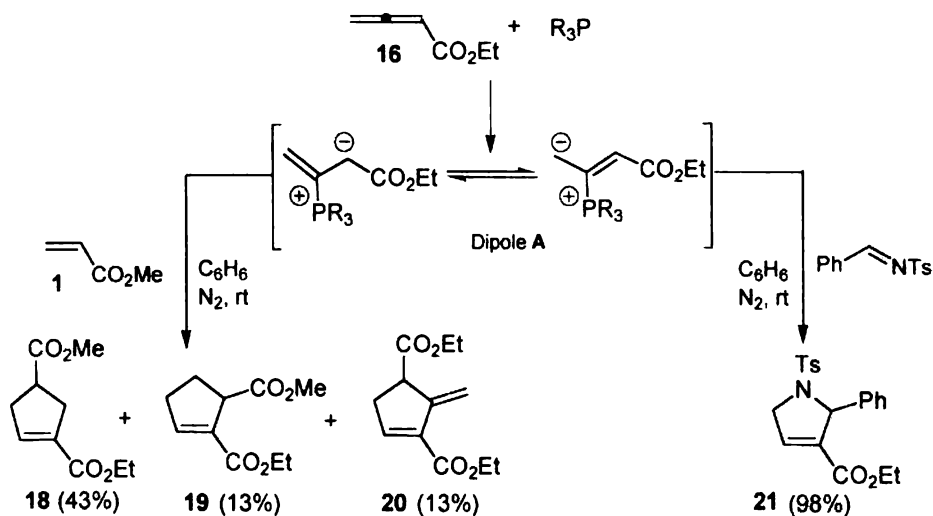

Scheme 8

The [3+2] cycloaddition reaction of the dipole **A** with alkenes has been applied to the synthesis of [60]-fullerene cycloadducts, L-glutamate analogues and pentabromopseudilin.¹⁹ Later work has shown that chiral phosphines catalyze the cycloaddition of **16** with electron-deficient olefins leading to the formation of homochiral cyclopentanoids.²⁰ A one-pot, three-component regioselective synthesis of cyclopentenes by the [3+2] cycloaddition of dipole **A** with electron-deficient olefins generated *in situ* was accomplished recently (Scheme 9).²¹

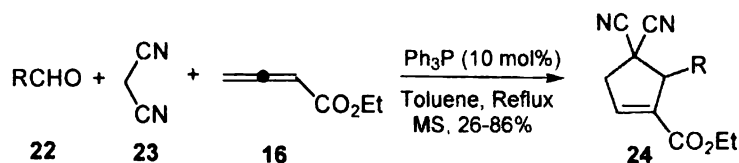

Scheme 9

Enantioselective [3+2] annulation of dipole **A** with imines has also been achieved using chiral phosphines such as BINAP and ferrocenylphosphetanes.²²

Annulation reactions of the allene derived 1,3-dipole **A** with 3-substituted chromones was studied by Ishar and co-workers. It was observed that the 1,3-dipole **A** adds regioselectively to the C2-C3 π -bond of 3-formylchromone **25**; the annulation and

concomitant deformylation yields the product **26**. In the case of azadiene **27**, a [4+3] annulation followed by tandem rearrangement yields **28** (Scheme 10).²³

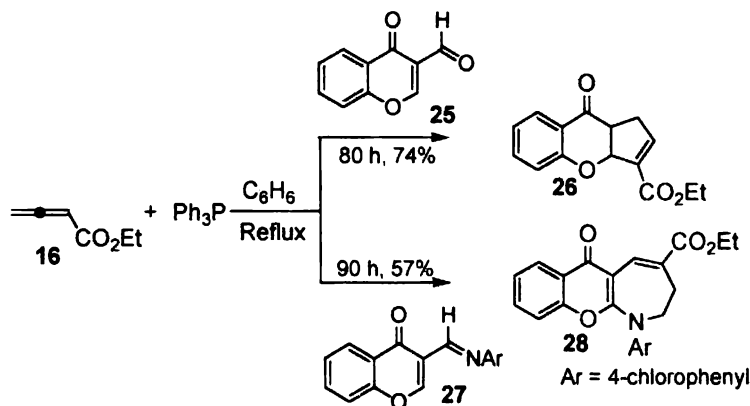

Scheme 10

The same group also showed that the allenic ester/ketone derived dipole **A** undergoes an unusual [8+2] annulation with tropone to yield **30** in high yields. The minor product **31** is obtained by the [6+3] cycloaddition and is observed only with the 2,3-butadienoate derived dipole (Scheme 11).²⁴

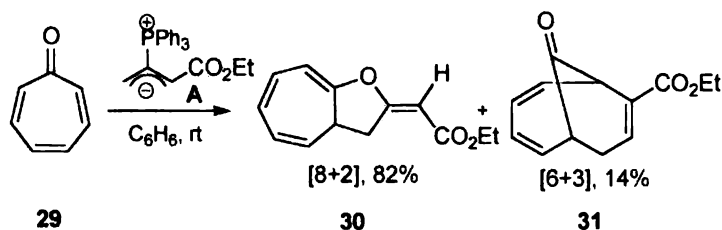

Scheme 11

The 1,3-dipole **A** also undergoes [3+2] cycloaddition with enones leading to the formation of spirocycles as shown below (Scheme 12).²⁵ Very recently, asymmetric version of this reaction was developed using chiral phosphines as catalysts.²⁶

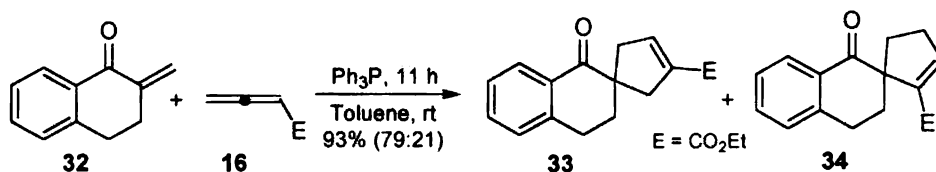

Scheme 12

The [3+2] cycloaddition strategy of the dipole **A** with C-O double bonds led to the formation of oxygen heterocycles as illustrated below (Scheme 13).²⁷

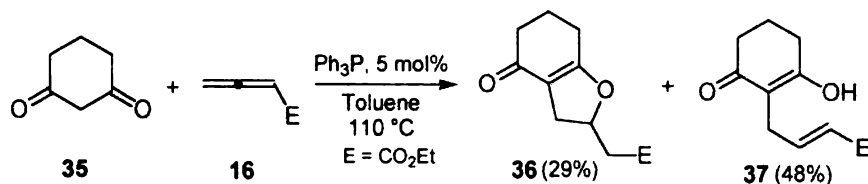

Scheme 13

The intramolecular [3+2] cycloaddition of electron-deficient 1,7-enynes under phosphine catalysis leading to the diastereoselective formation of substituted bicyclo[3.3.0] ring systems is also noteworthy in this context.²⁸

Kwon *et al.* observed that substitution of the hydrogen at the second position of 2,3-butadienoate with a methyl group will give rise to a 1,4-dipole synthon in presence of the phosphine. Thus by mixing 2-methyl-2,3-butadienoate **38** with *N*-tosylbenzaldimine in presence of catalytic amounts of tributylphosphine led to the formation of tetrahydropyridine **39** by a [4+2] annulation (Scheme 14).^{29a} Recently an asymmetric version of this reaction has been reported by another group by employing chiral phosphine catalysts.^{29b}

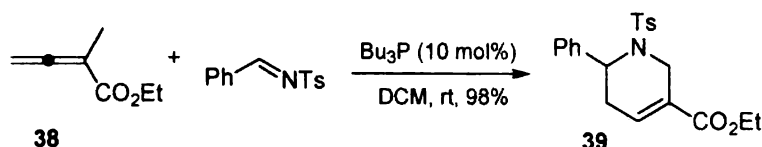

Scheme 14

This strategy was successfully applied by Kwon's group for the synthesis of the Macroline type indole alkaloid, alstonerine.³⁰ The tetrahydropyridine derivative **42** obtained by the [4+2] annulation of the allenolate **40** and the imine **41**, undergoes facile intramolecular Friedel-Crafts acylation to give the bridged bicycle **43** which can be converted to the key intermediate **44** of alstonerine (Scheme 15).

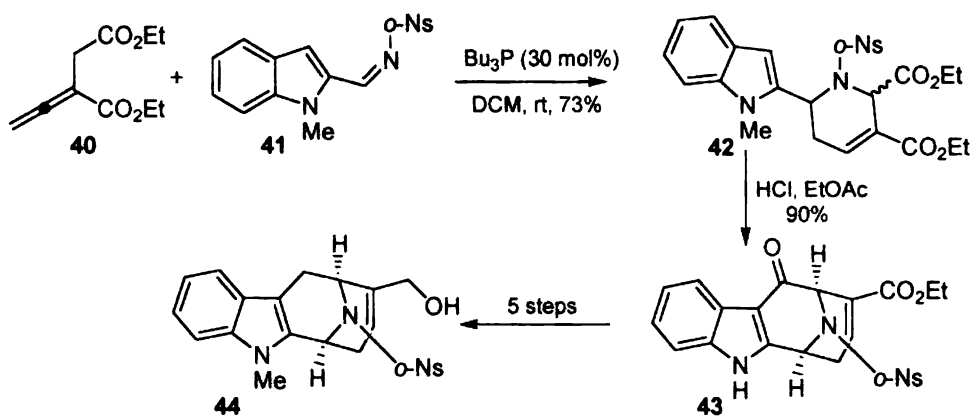

Scheme 15

Another interesting reaction reported recently by Lu *et al.* involves phosphine catalyzed annulation of modified allylic compounds with electron-deficient alkenes³¹ and with troponone.³² The ylide, formed by the reaction of **45** with triphenylphosphine in presence of base, reacts with N-phenyl maleimide **46** to yield the product **47** whereas it undergoes a [3+6] annulation with troponone to yield the bicyclic compound **48** as shown below (Scheme 16).

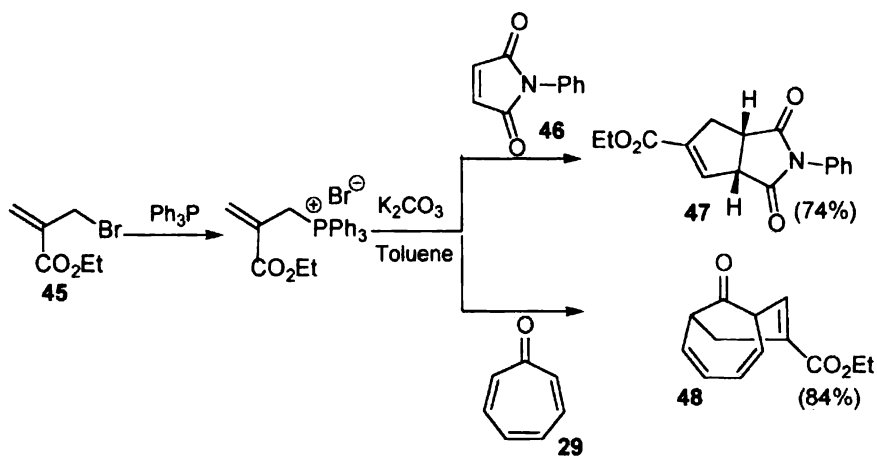

Scheme 16

Kwon *et al.* also showed that the zwitterion formed from the allenic ester and trialkylphosphine can exist in *E* or *Z* form and can react differently with aldehydes. The

Z-isomer reacts with aldehydes to form 1,3-dioxan-4-ylidenes, whereas the reaction of the *E*-isomer results in 2-pyrones (Scheme 17).³³

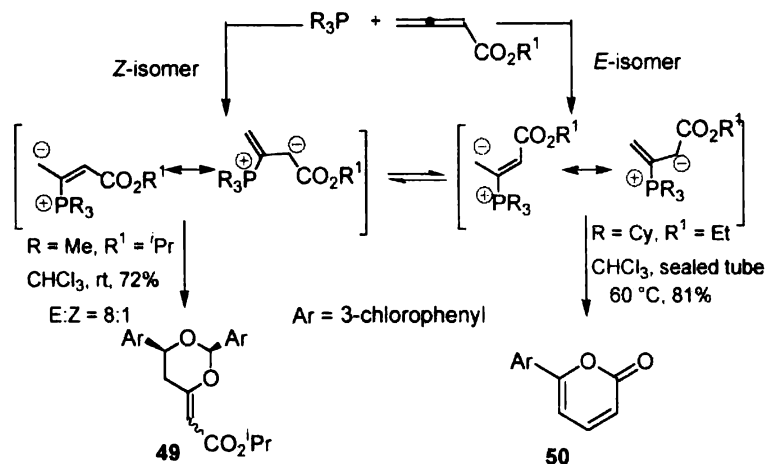

Scheme 17

Just as the intermediate derived from TPP and allenates has been used extensively to bring about various transformations, the zwitterion from TPP and DMAD has also been the subject of several investigations, starting from the pioneering work of Horner.³⁴ Triphenylphosphine reacts with activated acetylenes such as dimethyl acetylenedicarboxylate to yield adducts depending on the stoichiometry of the reagents used. The structure of these adducts has been discussed in chapter 1.

Winterfeldt in 1966, reported that the zwitterion formed from triphenylphosphine (TPP) and DMAD, can react with benzaldehyde to give γ -butyrolactone **53** as shown below (Scheme 18).³⁵

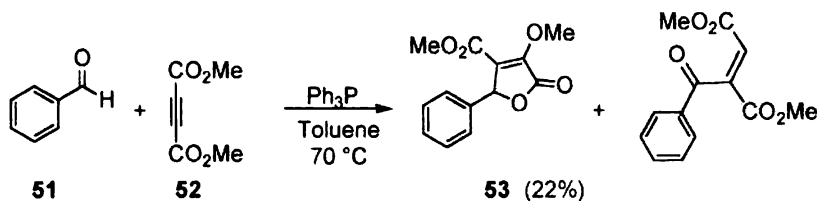

Scheme 18

Later Nozaki modified the Winterfeldt protocol using activated carbonyl compounds such as α -ketoesters and α -ketonitriles (Scheme 19).³⁶

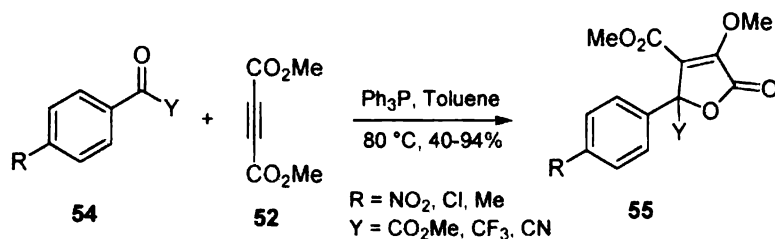

Scheme 19

Work in our laboratory has shown that the zwitterion generated by the addition of TPP to DMAD underwent facile addition to 1,2- and 1,4-benzoquinones to afford highly functionalized γ -spirolactones (Scheme 20).³⁷

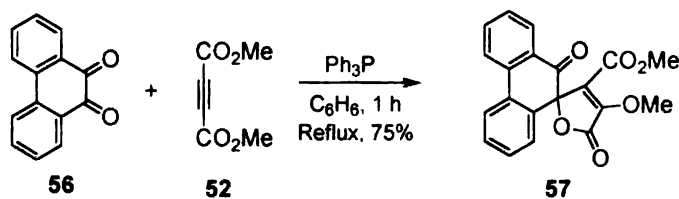

Scheme 20

Later work by Xu and Lu has shown that N-tosylimines also adds to the zwitterion to generate pyrrolidone derivatives.³⁸ An illustrative example is shown in scheme 21.

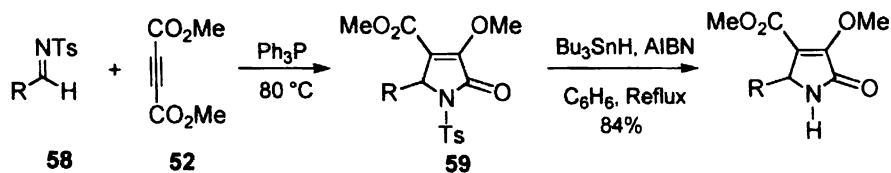

Scheme 21

Apart from the reactions in which phosphine acts as a catalyst, there are also reactions in which phosphine is needed in stoichiometric amounts. In such reactions, the phosphine participates in an intramolecular Wittig type reaction and subsequently gets ejected as triphenylphosphine oxide. A brief account of such reactions is presented in the following sections.

2.3 Phosphines as stoichiometric reagents

Reaction with Diethyl azodicarboxylate

Huisgen studied the reaction of TPP and DEAD and suggested the formation of the quasi 1,3-dipole **61**. The latter was shown to react with two equivalents of methyl propiolate to give the heterocyclic methylene phosphorane **62** and with one equivalent of DMAD to form **63** (Scheme 22)

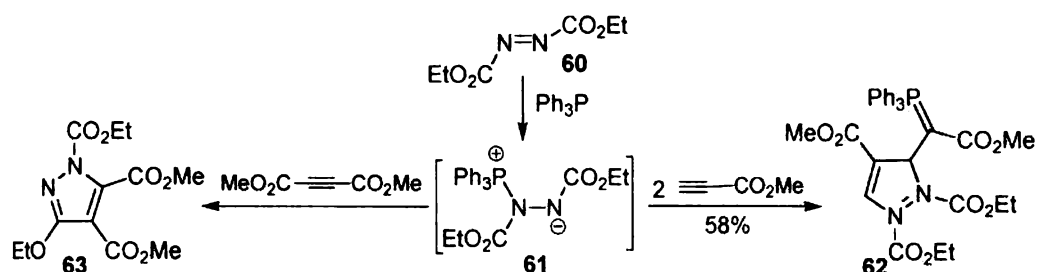

Scheme 22

The Huisgen betaine **61** has been elegantly utilized in the Mitsunobu reaction for the transformation of C-OH bond to C-X bond ($X = \text{O}, \text{N}, \text{S}, \text{C}$) with inversion in stereochemistry.⁴⁰ Very recently, an unusual reaction of salicylaldehyde **64** with TPP and di(*tert*-butyl) azodicarboxylate **60a** which led to the formation of hydrazone **65** rather than the normal Mitsunobu product was reported (Scheme 23).⁴¹ Similar unexpected transformation of ketones to vinyl hydrazines under normal Mitsunobu conditions was reported by Liu and co-workers also.⁴²

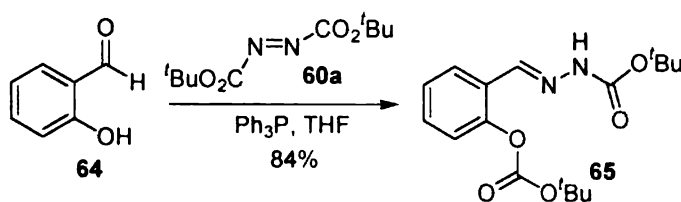

Scheme 23

Lee has recently reported the formation of different products by the reaction of the Huisgen zwitterion **61** with various carbonyl compounds.⁴³ Recent work in our laboratory has shown that the TPP-DEAD zwitterion can react with 1,2-dicarbonyl compounds like benzils and *o*-quinones to yield N,N-dicarboethoxy monohydrazones

and dihydro-1,2,3-benzoxadiazoles respectively (Scheme 24).^{44,45} The first step in both reactions is the addition of the Huisgen zwitterion **61** to one of the carbonyl groups of the dione to form a tetrahedral intermediate followed by the elimination of triphenylphosphine oxide. A nitrogen-to-nitrogen carboxyl transfer then takes place to deliver **67**, while aromatization followed by ring closure leads to the product **69**.

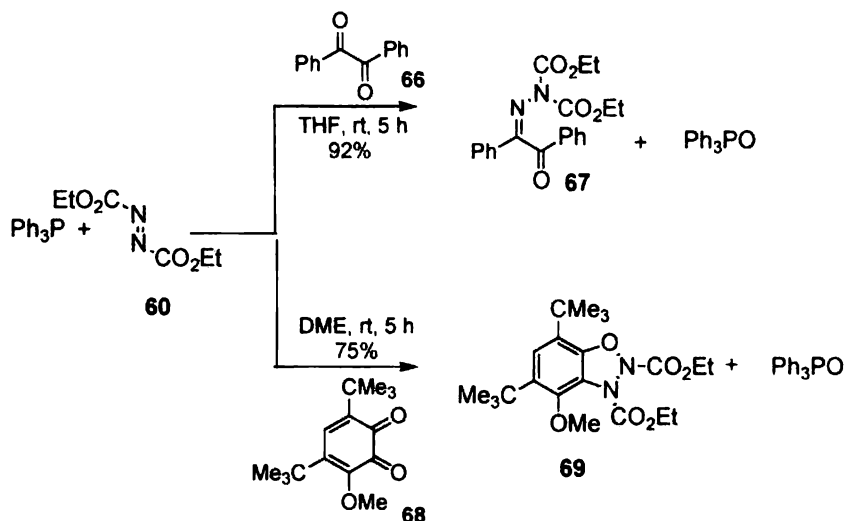

Scheme 24

Yavari *et al.* reported a new approach to 4-carboxymethyl coumarin *via* TPP mediated reaction of phenols with DMAD.⁴⁶ CH-acids such as **70** afforded highly functionalized 2H-pyran derivatives *via* the electrocyclic ring opening of the intermediate **71** (Scheme 25).⁴⁷

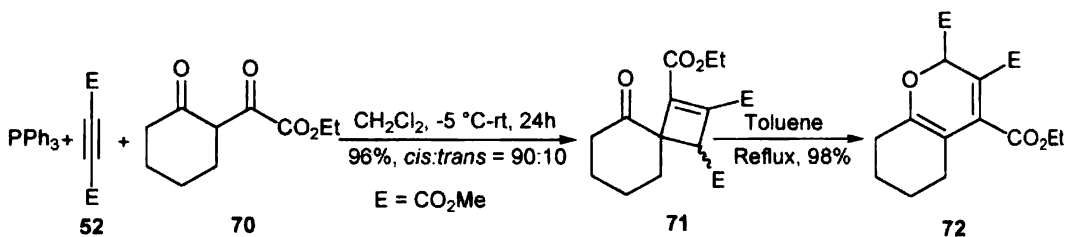

Scheme 25

Phosphine mediated reductive condensation of γ -acyloxy butynoates has led to the formation of substituted furans as shown below (Scheme 26).⁴⁸

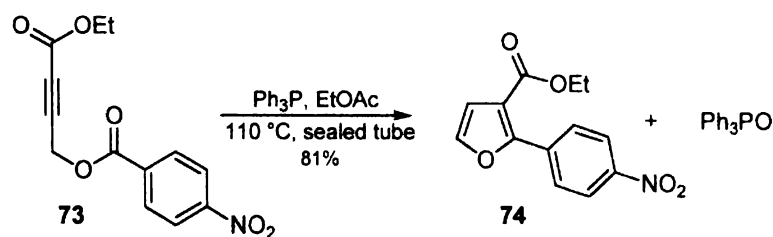

Scheme 26

2.4 Statement of the problem

As already mentioned, work in our laboratory has shown that the 1,3-dipolar intermediate formed from TPP and DMAD can be intercepted with the carbonyl group of *o*- and *p*-quinones leading to the formation of γ -butyrolactones.³⁷ However, the reactivity of electrophilic C-C double bonds towards these species has not yet been explored. In the context of our longstanding interest in the area of multicomponent reactions mediated by zwitterionic species,⁴⁹ it was of interest to undertake a detailed investigation of the reactivity of TPP-DMAD dipole with electrophilic styrenes such as dicyanostyrenes and β -nitrostyrenes. The results of our studies are presented here.

2.5 Results and Discussion

The dicyanostyrenes (benzylidene malononitriles) required for the studies were prepared by the Knoevenagel condensation of aromatic aldehydes and active methylene compounds while the β -nitrostyrenes were prepared by the classical Henry reaction of nitromethane with aldehydes in presence of base. The compounds selected for our studies are listed below (Scheme 27).

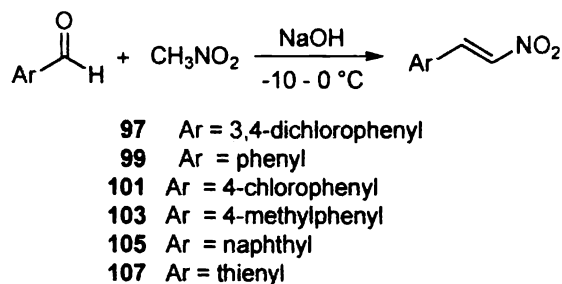
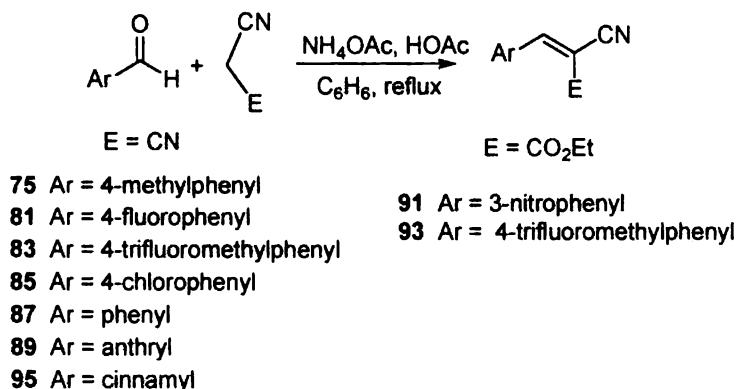

Scheme 27

In an initial experiment, 4-methyl benzylidene malononitrile **75** and DMAD **52** were stirred in dry DME under nitrogen at room temperature. After two minutes, stoichiometric amount of TPP was added and stirring was continued until the consumption of the starting material was complete as indicated by TLC. After 2 h, removal of solvent followed by column chromatography of the residue on silica gel afforded the highly substituted cyclopentenyl phosphorane **76** in 63% yield (Scheme 28).

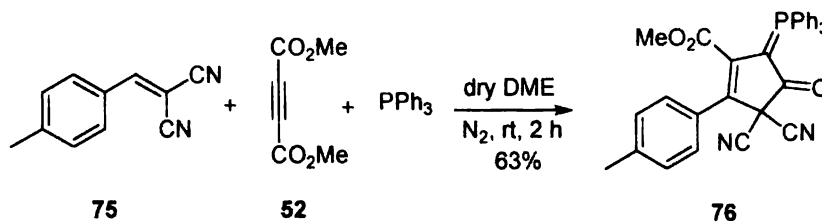

Scheme 28

The structure **76** was assigned to the product on the basis of spectroscopic data. The IR spectrum of **76** showed absorptions at 1743 cm^{-1} and 2242 cm^{-1} indicating the presence of ester and cyano functionalities respectively while the carbonyl adjacent to the cyano group was discernible at 1660 cm^{-1} . In the ^1H NMR spectrum, the methoxy protons of the ester group resonated at δ 2.86. The two carbonyls showed resonance signals in the ^{13}C NMR spectrum at δ 180.8 and δ 165.9, the latter corresponding to that of the ester.

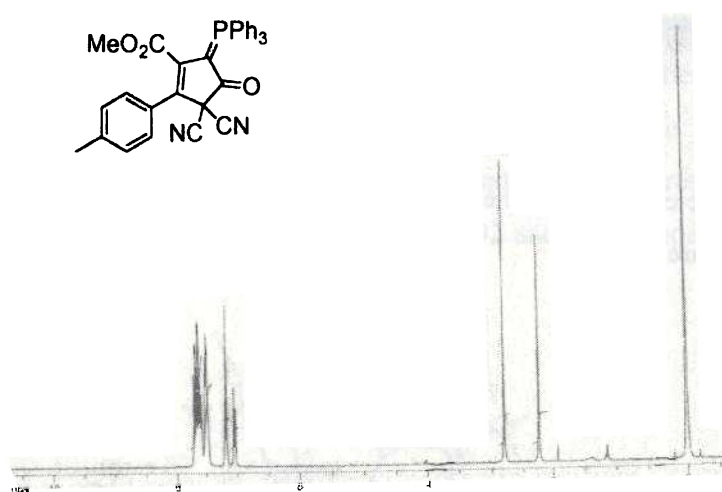

Figure 1 ^1H NMR spectrum of **76**

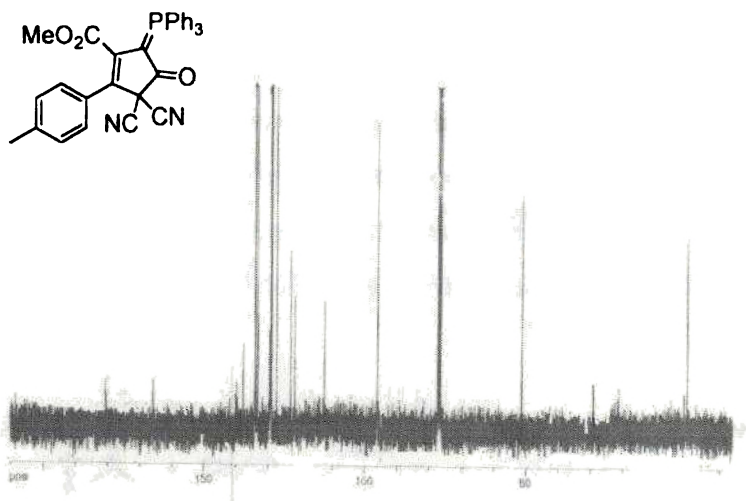

Figure 2 ¹³C NMR spectrum of 76

Conclusive evidence for the assigned structure was obtained by single crystal X-ray analysis (Figure 3).

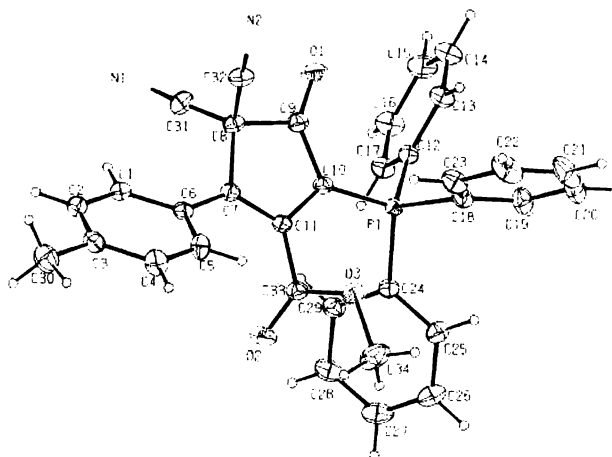
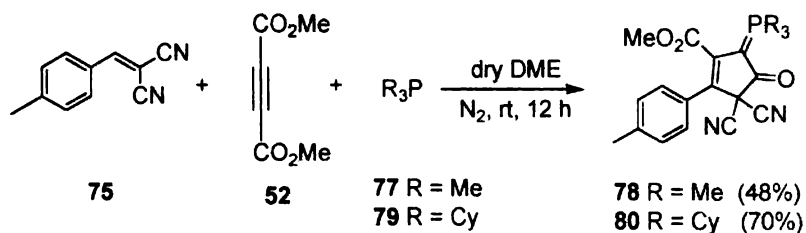

Figure 3 Single X-ray crystal structure of 76

The phosphine component of the reaction was found to be variable; use of trimethylphosphine and tricyclohexylphosphine, led to the formation of the phosphoranes 78 and 80 respectively (Scheme 29).



Scheme 29

A variety of dicyanostyrenes were then screened as the third component. The results obtained established the generality of the reaction and are presented in table 1. In all cases the products obtained were characterized by spectroscopic methods. Replacing the dicyanostyrene with aryl cyanoacrylate in the reaction with triphenylphosphine and DMAD also led to the formation of cyclic phosphoranes. This is illustrated in the reaction of aryl cyanoacrylates **91** and **93**, which under the same reaction conditions, participated in the MCR to yield the phosphoranes **92** and **94** in good yields (entries 6 and 7).

Table 1

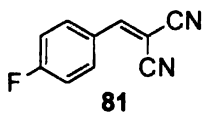
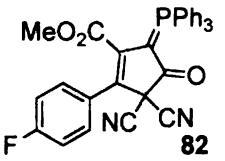
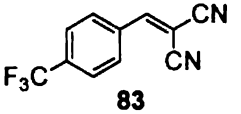
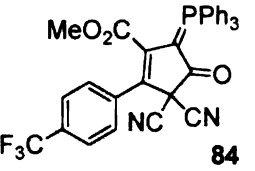
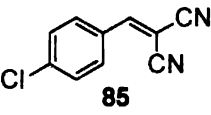
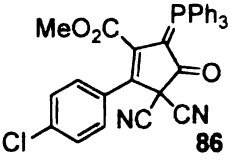
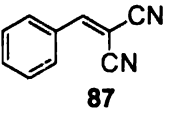
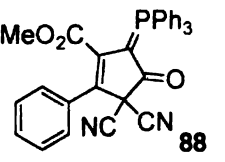
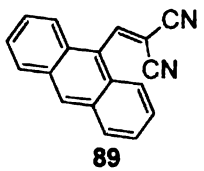
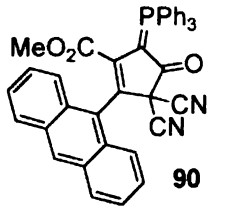
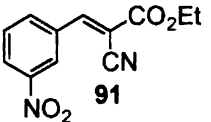
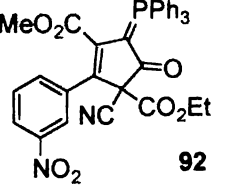
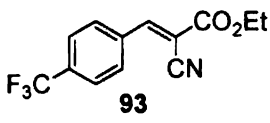
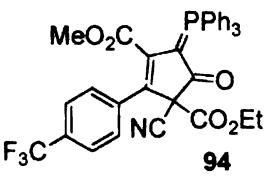
Entry	Substrate	Product	Yield (%)
1	 81	 82	80
2	 83	 84	77
3	 85	 86	65
4	 87	 88	76
5	 89	 90	66
6	 91	 92	69
7	 93	 94	62

Reaction conditions: Dry DME, RT, N₂

Introduction of extended conjugation in the olefinic component of the MCR did not alter the reactivity; **95** on reaction with DMAD and TPP yielded the vinyl cyclopentenyl phosphorane **96** in moderate yield as shown below.

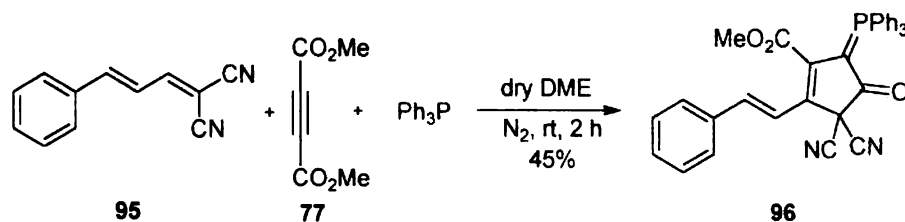

Scheme 30

In view of the success of the above reactions, we explored the use of β -nitrostyrenes as the third component in this reaction. Treatment of 3,4-dichloro- β -nitrostyrene, **97** with DMAD and triphenylphosphine in dry DME at room temperature led to the formation of the phosphorane **98** (Scheme 31).

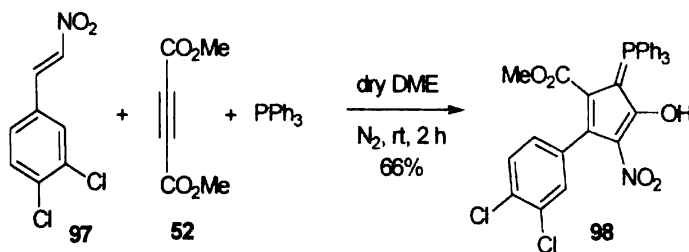

Scheme 31

The product was characterized on the basis of spectroscopic analysis. In the ^1H NMR spectrum of **98** the enolic -OH proton signal was visible at δ 10.71 and was exchangeable with D_2O . The protons of the ester group were discernible at δ 2.90. The ester carbonyl carbon resonated at δ 165.8 in the ^{13}C NMR spectrum. Mass spectral analysis also supported the structural assignment. The mass spectrum of the products obtained by the fast atom bombardment showed the base peak corresponding to triphenylphosphine at 262 mass units indicating the presence of triphenylphosphine in the molecule as well as its propensity to cleave easily.

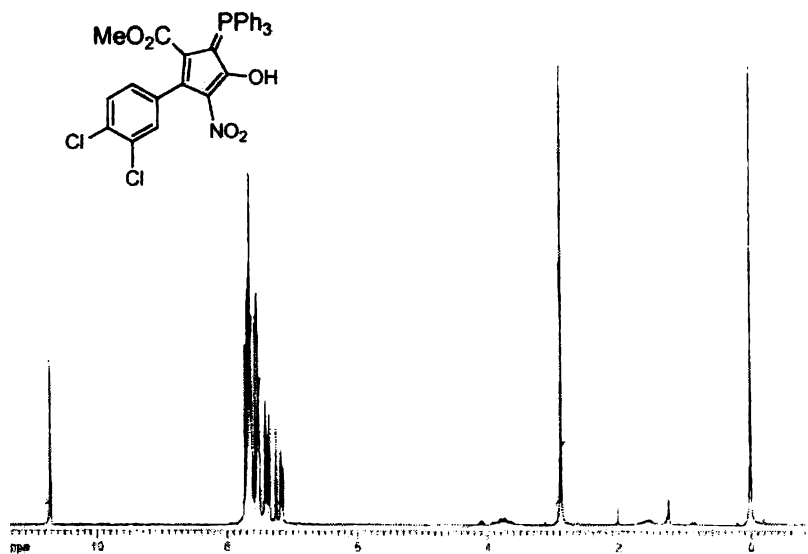

Figure 4 ^1H NMR spectrum of 98

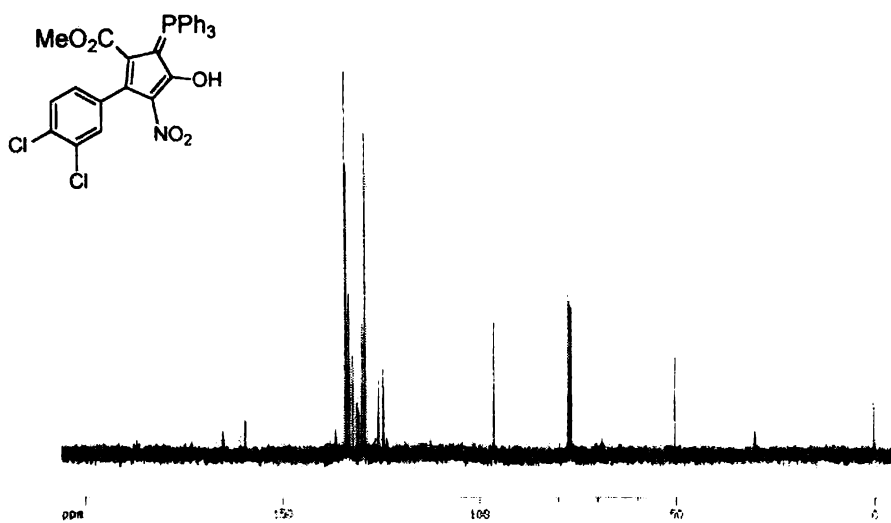
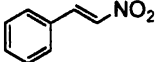
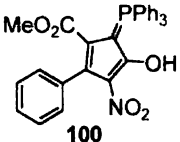
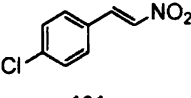
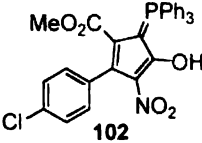
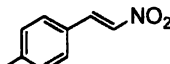
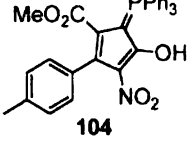
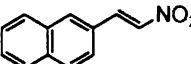
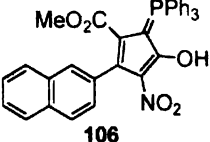
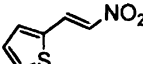
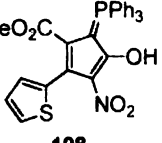

Figure 5 ^{13}C NMR spectrum of 98

The reaction was found to be general with other β -nitrostyrenes and the results are listed in table 2.

Table 2

Entry	Substrate	Product	Yield (%)
1	 99	 100	76
2	 101	 102	59
3	 103	 104	50
4	 105	 106	41
5	 107	 108	23

Reaction conditions: Dry DME, RT, N₂

To study the reactivity of the alkene component further, we set out to investigate the reactivity of other electron deficient π systems given below. The Knoevenagel condensation product **109**, of diethyl malonate and aldehyde was found to be inefficient in generating the phosphoranes by the reaction with TPP and DMAD; the starting materials were completely recovered. The allene ester **110**, methyl phenyl propiolate **111**, maleimide **112** and its N-phenyl derivative **46** were also found to be inefficient in

generating the phosphoranes by this reaction presumably due to the lower electrophilicity of these compounds compared to dicyanostyrenes and β -nitrostyrenes.

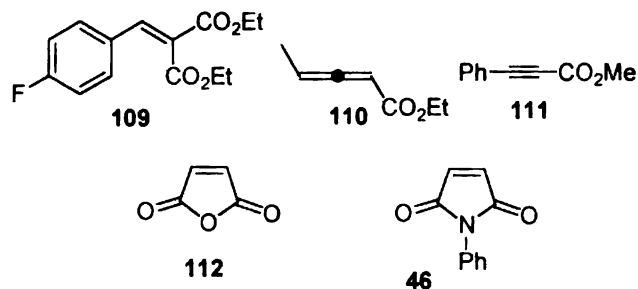

Figure 6

Attempts to vary the alkyne component were also unsuccessful. Thus the phosphorane formation was observed only in the case of dimethyl acetylenedicarboxylate. The electron-deficient systems studied are listed below.

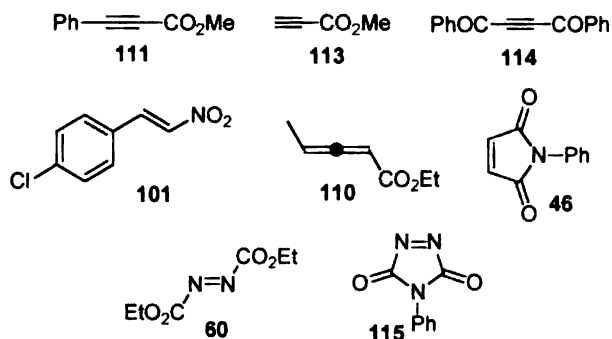
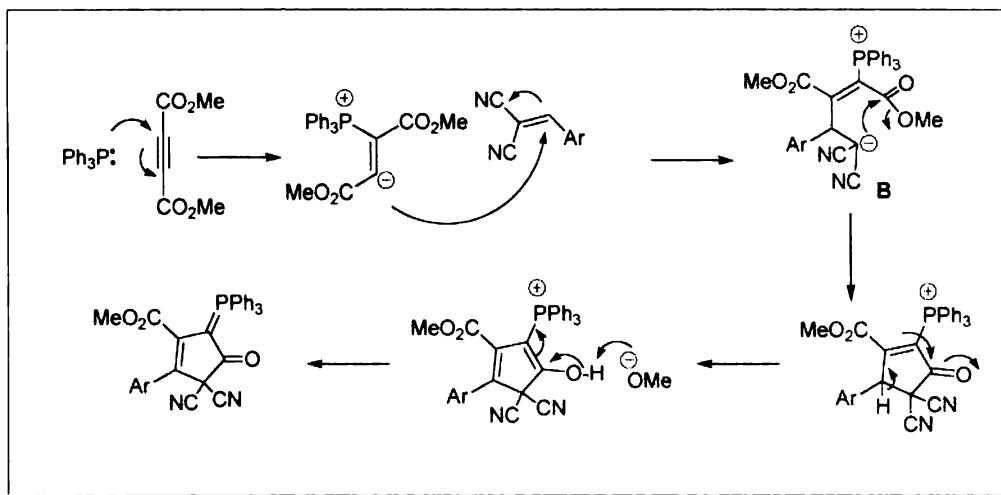

Figure 7

A mechanistic rationale for the reaction may be outlined as follows. The initially formed zwitterionic intermediate from triphenylphosphine and DMAD can conceivably add to the activated styrene in a Michael fashion to yield a betaine **B**. The latter on cyclization and subsequent deprotonation can deliver the phosphorane (Scheme 32). In the reaction involving β -nitrostyrenes, DMAD and triphenylphosphine, the initially formed keto product tautomerizes to the enol form by the removal of the highly acidic proton near the nitro group to yield the cyclopentadienylidene phosphorane.



Scheme 32

Phosphonium ylides are known to undergo a wide variety of reactions because of their unique molecular and electronic structures.^{1d} Hydrolysis, reduction and oxidation are reactions, which can potentially cleave the carbon-phosphorus bond. In view of this, we carried out a limited investigation of the reactivity of **76**. An attempted Wittig reaction of **76** with 4-nitro benzaldehyde failed presumably due to the unusual stability of the ylide. The ylide was also unaffected by boiling alkali. Attempted reduction with lithium aluminium hydride resulted in intractable mixtures. Oxidizing agents like oxone in THF/H₂O and NaIO₄ in DCM/H₂O did not oxidize the molecule. Finally a successful cleavage of the C-P bond was effected by the reaction of a methanolic solution of cerium(IV) ammonium nitrate with the ylide in dry methanol in an oxygen atmosphere. This reaction led to the formation of a masked 1,2-dione **116** in 57% yield (Scheme 33).

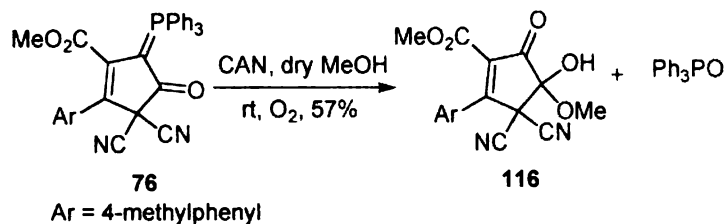

Scheme 33

The OH proton of **116** was discernible at δ 7.20 in the ^1H NMR spectrum. Interestingly, it was not exchangeable with D_2O presumably due to the strong hydrogen bonding with the carbonyl group. The methoxy protons of the ester moiety resonated at δ 3.84 while the hemiacetal-methoxy protons resonated at δ 3.77. The ester carbonyl resonated at δ 159.6 while the conjugated ketone displayed its signal at δ 180.9 in the ^{13}C NMR spectrum. Oxidation of **76** with hydrogen peroxide also resulted in identical products albeit in lower yield.

2.6 Conclusion

In conclusion, we have devised a novel one-pot three component reaction of triphenylphosphine, DMAD and electron deficient styrenes, leading to a facile synthesis of highly substituted phosphoranes. This is one of the rare reactions in which the phosphine gets incorporated in the product. The variability of the reaction with respect to the styrene and the phosphine component is noteworthy. The cyclopentenyl phosphoranes thus formed can be easily oxidized to cyclopentene 1,2-diones which may serve as useful intermediates in synthesis. It is noteworthy that the cyclopentenyl phosphoranes reported here have close resemblance to the triphenylphosphoniumcyclopentadienylide prepared by Ramirez and Levy.⁵⁰

2.7 Experimental Details

General: Melting points were recorded on a Büchi melting point apparatus and are uncorrected. NMR spectra were recorded at 300 (^1H) and 75 (^{13}C) MHz respectively on a Bruker Avance DPX-300 MHz NMR spectrometer. Chemical shifts are reported (δ) relative to TMS (^1H) and CDCl_3 (^{13}C) as the internal standards. Coupling constants (J) are reported in hertz (Hz). Mass spectra were recorded under FAB/LRMS and/or EI/HRMS at 5000 resolution using JEOL mass spectrometer. IR spectra were recorded on Bomem MB Series FT-IR spectrophotometer. Elemental analyses were performed on a Perkin Elmer-2400 Elemental Analyzer. Dimethyl acetylenedicarboxylate was purchased from Aldrich Chemical Co. and was used without further purification. Triphenylphosphine was purchased from Merck while trimethyl and

tricyclohexylphosphines were purchased from Aldrich Chemical Co. Arylmethylidene malononitriles and aryl cyanoacrylates were prepared by the Knoevenagel condensation of corresponding aromatic aldehydes with malononitrile and ethyl cyanoacetate respectively. β -nitrostyrenes were prepared by the classical Henry reaction of aldehydes with nitromethane in presence of alkali. Commercial grade solvents were distilled prior to use. Analytical thin layer chromatography was performed on glass plates coated with silica gel containing calcium sulfate as the binder. Gravity column chromatography was performed using 100-200 mesh silica gel and the mixtures of hexanes-ethyl acetate were used for elution.

General Procedure for the Synthesis of Phosphoranes by the Reaction of Phosphine, DMAD and Activated styrenes.

A solution of dimethyl acetylenedicarboxylate (63 mg, 0.44 mmol) and activated styrene (0.29 mmol) in 8 mL dry DME as the solvent was stirred at room temperature under nitrogen atmosphere for 2 minutes. To this solution was added the phosphine (0.32 mmol) and the reaction mixture was stirred. After completion of the reaction as indicated by the TLC, the solvent was removed on a rotavapour and the residue was subjected to column chromatography on silica gel using hexanes-ethyl acetate solvent mixture (50:50) to afford the pure product.

3,3-Dicyano-4-oxo-2-*p*-tolyl-5-(triphenyl- λ^5 -phosphanylidene)-cyclopent-1-ene carboxylic acid methyl ester **76**

To a solution of DMAD (63 mg, 0.44 mmol) and 4-methyl benzylidenemalononitrile **75** (50 mg, 0.29 mmol) was added triphenylphosphine (83 mg, 0.32 mmol) and stirred at room temperature for 2 h. The reaction mixture was then processed as described in the general procedure to afford the phosphorane **76** as a yellow solid (100 mg, 63%), mp 207-208 °C (recrystallized from CH₂Cl₂-hexanes).

IR (KBr) ν_{\max} : 3056, 2954, 2928, 2242, 1743, 1660, 1578, 1480, 1429, 1336, 1290, 1212, 1176, 1109, 1022, 965 cm⁻¹.

¹H NMR: δ 7.74-7.62 (m, 9H), 7.57-7.51 (m, 5H), 7.24-7.22 (m,

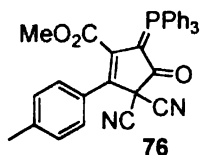

3H), 7.10-7.08 (m, 2H), 2.86 (s, 3H), 2.09 (s, 3H).

^{13}C NMR: δ 180.8, 165.9, 139.8, 137.8, 134.2, 134.0, 133.4, 133.3, 129.6, 129.3, 129.2, 129.0, 127.4, 123.0, 121.8, 112.5, 51.4, 29.8, 21.3.

Elemental Analysis Calcd for $\text{C}_{34}\text{H}_{25}\text{N}_2\text{O}_3\text{P}$: C = 75.55; H = 4.46; N = 5.18; Found: C = 75.36; H = 4.02; N = 5.37.

Mass spectrometric analysis (LRMS-FAB) m/z calcd for $\text{C}_{34}\text{H}_{25}\text{N}_2\text{O}_3\text{P}$ $[\text{M}+2\text{H}]^+$: 542.18, found: 542.55.

3,3-Dicyano-4-oxo-2-*p*-tolyl-5-(trimethyl- λ^5 -phosphanylidene)-cyclopent-1-ene carboxylic acid methyl ester **78**

To a stirring solution of DMAD (63 mg, 0.44 mmol) and 4-methylbenzylidenemalononitrile **75** (50 mg, 0.29 mmol) was added trimethylphosphine (0.03 mL, 0.32 mmol) and the stirring was continued for 12 h. It was then processed as described in the general procedure to afford the phosphorane **78** as a yellow viscous liquid (49 mg, 48%).

IR (thin film) ν_{max} : 2936, 2852, 2362, 1729, 1643, 1542, 1432, 1318, 1285, 1232, 1205, 1170, 1510 cm^{-1} .

^1H NMR: δ 7.88-7.79 (m, 2H), 7.51-7.45 (m, 2H), 3.54 (s, 3H), 2.08 (s, 3H), 1.94 (s, 3H), 1.92 (s, 3H), 1.89 (s, 3H).

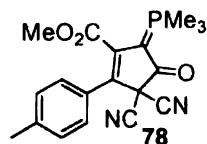

^{13}C NMR: δ 181.2, 166.5, 133.1, 132.9, 130.5, 128.2, 127.9, 127.1, 126.4, 112.4, 52.2, 29.6, 21.2, 13.7, 12.9.

Mass spectrometric analysis (LRMS-FAB) m/z calcd for $\text{C}_{19}\text{H}_{19}\text{N}_2\text{O}_3\text{P}$ $[\text{M}+\text{H}]^+$: 355.11, found: 355.52.

3,3-Dicyano-4-oxo-*p*-tolyl-5-(tricyclohexyl- λ^5 -phosphanylidene)-cyclopent-1-ene carboxylic acid methyl ester **80**

To a solution of DMAD (63 mg, 0.44 mmol) and 4-methylbenzylidenemalononitrile **75** (50 mg, 0.29 mmol) was added tricyclohexylphosphine (91 mg, 0.32 mmol). The reaction mixture was stirred for 12 h and was then processed as

described in the general procedure to afford the phosphorane **80** as a yellow solid (113 mg, 70%), mp 123-124 °C (recrystallized from CH₂Cl₂-hexanes).

IR (KBr) ν_{\max} : 2937, 2854, 2360, 1730, 1645, 1546, 1442, 1328, 1290, 1240, 1205, 1176, 1600 cm⁻¹.

¹H NMR: δ 7.84-7.78 (m, 2H), 7.47-7.41 (m, 2H), 3.55 (s, 3H), 2.92-2.79 (m, 3H), 2.07 (s, 3H), 1.95-1.79 (m, 6H), 1.62-1.51 (m, 15H), 1.31-1.23 (m, 9H).

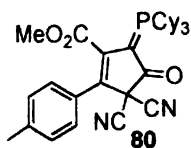

¹³C NMR: δ 181.6, 167.6, 133.2, 130.4, 129.1, 128.1, 127.7, 126.3, 124.7, 112.8, 108.9, 64.7, 53.4, 31.6, 31.0, 27.7, 27.4, 27.3, 27.1, 26.9, 25.7, 21.3, 14.1.

Mass spectrometric analysis (LRMS-FAB) m/z calcd for C₃₄H₄₃N₂O₃P [M+H]⁺: 559.30, found: 559.33.

3,3-Dicyano-4-oxo-2-*p*-fluoro-phenyl-5-(triphenyl- λ^5 -phosphanylidene)-cyclopent-1-ene carboxylic acid methyl ester **82**

To a solution of DMAD (63 mg, 0.44 mmol) and 4-fluoro benzylidenemalononitrile **81** (50 mg, 0.29 mmol) was added triphenylphosphine (83 mg, 0.32 mmol) and stirred for 2 h. Usual processing of the reaction mixture afforded the phosphorane **82** as a yellow solid (126 mg, 80%), mp 208-209 °C (recrystallized from CH₂Cl₂-hexanes).

IR (KBr) ν_{\max} : 3065, 2935, 2922, 2248, 1742, 1670, 1570, 1552, 1525, 1449, 1418, 1264, 1207, 1089, 1011, 970 cm⁻¹.

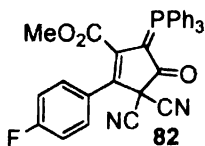

$^1\text{H NMR}$: δ 7.73-7.50 (m, 15H), 7.32-7.27 (m, 4H), 2.92 (s, 3H).

$^{13}\text{C NMR}$: δ 180.6, 165.3, 140.5, 134.1, 133.8, 133.7, 133.4, 132.0, 131.9, 131.0, 129.1, 129.0, 128.8, 128.7, 128.3, 128.1, 122.4, 121.3, 116.1, 112.2, 66.4, 51.5, 29.6.

Elemental Analysis Calcd for $\text{C}_{33}\text{H}_{22}\text{FN}_2\text{O}_3\text{P}$: C = 72.79; H = 4.07; N = 5.14; Found: C = 72.56; H = 4.02; N = 5.18.

Mass spectrometric analysis (LRMS-FAB) m/z calcd for $\text{C}_{33}\text{H}_{22}\text{FN}_2\text{O}_3\text{P} [\text{M}+2\text{H}]^+$: 546.14, found: 546.15.

3,3-Dicyano-4-oxo-2-*p*-trifluoromethyl-phenyl-5-(triphenyl- λ^5 -phosphanylidene)-cyclopent-1-ene carboxylic acid methyl ester **84**

To a solution of DMAD (63 mg, 0.44 mmol) and 4-trifluoromethyl benzylidenemalononitrile **83** (66 mg, 0.29 mmol) was added triphenylphosphine (83 mg, 0.32 mmol). The reaction mixture was stirred for 2 h and usual processing afforded the phosphorane **84** as a yellow solid (132 mg, 77%), mp 206-207 °C (recrystallized from CH_2Cl_2 -hexanes).

IR (KBr) ν_{max} : 3072, 2928, 2856, 2248, 1727, 1671, 1619, 1583, 1563, 1480, 1434, 1408, 1320, 1207, 1166, 1120, 1063, 955 cm^{-1} .

$^1\text{H NMR}$: δ 7.76-7.67 (m, 9H), 7.61-7.56 (m, 8H), 7.48-7.45 (m, 2H), 2.90 (s, 3H).

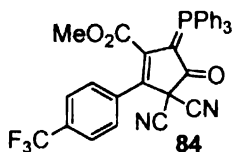

$^{13}\text{C NMR}$: δ 180.8, 165.5, 134.2, 134.0, 133.6, 133.5, 129.4, 129.3, 129.1, 127.5, 125.6, 125.5, 122.6, 121.3, 112.2, 51.7, 29.7, 22.7.

Elemental Analysis Calcd for: $\text{C}_{34}\text{H}_{22}\text{F}_3\text{N}_2\text{O}_3\text{P}$: C = 68.69; H = 3.73; N = 4.71; Found: C = 68.56; H = 3.52; N = 4.68.

Mass spectrometric analysis (LRMS-FAB) m/z calcd for $\text{C}_{34}\text{H}_{22}\text{F}_3\text{N}_2\text{O}_3\text{P} [\text{M}+2\text{H}]^+$: 596.13, found: 596.20.

3,3-Dicyano-4-oxo-2-*p*-chloro-phenyl-5-(triphenyl- λ^5 -phosphanylidene)-cyclopent-1-ene carboxylic acid methyl ester **86**

To a solution of DMAD (63 mg, 0.44 mmol) and 4-chloro benzylidenemalononitrile **85** (54 mg, 0.29 mmol) was added triphenylphosphine (83 mg, 0.32 mmol) and stirred for 2 h. Usual processing of the reaction mixture afforded the phosphorane **86** as a yellow solid (105 mg, 65%), mp 209-210 °C (recrystallized from CH₂Cl₂-hexanes).

IR (KBr) ν_{\max} : 3067, 2948, 2922, 2248, 1743, 1671, 1583, 1557, 1526, 1459, 1429, 1284, 1217, 1099, 1011, 970 cm⁻¹.

¹H NMR: δ 7.75-7.54 (m, 15H); 7.30-7.25 (m, 4H); 2.97 (s, 3H).

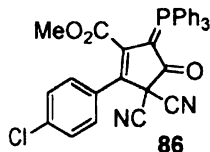

¹³C NMR: δ 180.4, 165.4, 141.5, 134.0, 133.9, 133.8, 133.4, 132.0, 131.9, 131.0, 129.2, 129.0, 128.8, 128.7, 128.5, 128.3, 122.6, 121.4, 116.1, 112.3, 66.6, 51.5, 29.6.

Elemental Analysis Calcd for C₃₃H₂₂ClN₂O₃P: C = 70.66; H = 3.95; N = 4.99; Found: C = 70.56; H = 3.62; N = 4.89.

Mass spectrometric analysis (LRMS-FAB) m/z calcd for C₃₃H₂₂ClN₂O₃P [M+2H]⁻: 562.11, found: 562.55.

3,3-Dicyano-4-oxo-2-phenyl-5-(triphenyl- λ^5 -phosphanylidene)-cyclopent-1-ene carboxylic acid methyl ester **88**

To a solution of DMAD (63 mg, 0.44 mmol) and benzylidene malononitrile **87** (54 mg, 0.29 mmol) was added triphenylphosphine (83 mg, 0.32 mmol) and stirred for 2 h. Usual processing of the reaction mixture afforded the phosphorane **88** as a yellow solid (115 mg, 76%), mp 204-205 °C (recrystallized from CH₂Cl₂-hexanes).

IR (KBr) ν_{\max} : 3067, 2954, 2248, 1733, 1655, 1485, 1429, 1351, 1284, 1212, 1104, 1017, 955 cm⁻¹.

¹H NMR: δ 7.77-7.65 (m, 6H), 7.60-7.54 (m, 6H), 7.48-7.28 (m, 8H), 2.88 (s, 3H).

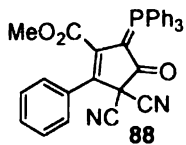

¹³C NMR: δ 180.8, 165.8, 140.6, 140.4, 134.1, 134.0, 133.4, 133.3, 132.5, 132.1, 131.9, 131.8, 129.2, 129.0, 128.5, 128.4, 128.0, 127.5, 122.9, 121.7, 117.8, 112.5, 66.2, 51.4, 29.7.

122.9, 121.7, 117.8, 112.5, 66.2, 51.4, 29.7.

Mass spectrometric analysis (LRMS-FAB) m/z calcd for $C_{33}H_{23}N_2O_3P$ $[M+2H]^+$: 528.14, found: 528.04.

3,3-Dicyano-4-oxo-2-anthryl-5-(triphenyl- λ^5 -phosphanylidene)-cyclopent-1-ene carboxylic acid methyl ester **90**

To a solution of DMAD (63 mg, 0.44 mmol) and anthrylidene malononitrile **89** (50 mg, 0.29 mmol) was added triphenylphosphine (83 mg, 0.32 mmol) and stirred for 2 h. Usual processing of the reaction mixture afforded the phosphorane **90** as an yellow solid (120 mg, 66%), mp 210-211 °C (recrystallized from CH_2Cl_2 -hexanes).

IR (KBr) ν_{max} : 3051, 2953, 2928, 2246, 1743, 1665, 1588, 1485, 1439, 1336, 1253, 1223, 1099, 996 cm^{-1} .

1H NMR: δ 8.44 (s, 1H), 8.18-8.15 (d, 2H, $J = 8.74$ Hz), 7.98-7.96 (d, 2H, $J = 8.24$ Hz), 7.86-7.78 (m, 6H), 7.70-7.42 (m, 13H), 2.40 (s, 3H).

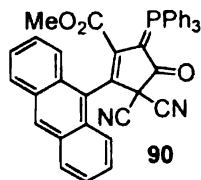

^{13}C NMR: δ 181.2, 164.4, 134.1, 133.9, 133.4, 133.3, 131.8, 131.4, 129.3, 129.1, 128.5, 128.4, 126.4, 125.9, 125.3, 123.6, 122.4, 112.1, 63.3, 60.3, 51.1, 29.8.

Mass spectrometric analysis (LRMS-FAB) m/z calcd for $C_{41}H_{27}N_2O_3P$ $[M+2H]^+$: 628.20, found: 628.40.

3-Cyano-3-carboxymethyl-4-oxo-2-*m*-nitro-phenyl-5-(triphenyl- λ^5 -phosphanylidene)-cyclopent-1-ene carboxylic acid methyl ester

To a solution of DMAD (63 mg, 0.44 mmol) and 3-nitrophenyl cyanoacrylate **89** (72 mg, 0.29 mmol) was added triphenylphosphine (83 mg, 0.32 mmol) and stirred for 2 h. Usual processing of the reaction mixture afforded the phosphorane **92** as an yellow solid (124 mg, 69%), mp 218-219 °C (recrystallized from CH_2Cl_2 -hexanes).

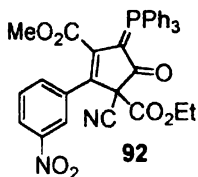

IR (KBr) ν_{\max} : 3007, 2970, 2954, 2243, 1743, 1645, 1573, 1552, 1532, 1475, 1429, 1352, 1257, 1207, 1094, 1027 cm^{-1} .

^1H NMR: δ 8.04-8.02 (m, 2H), 7.78-7.69 (m, 6H), 7.67-7.64 (m, 4H), 7.58-7.53 (m, 6H), 7.48-7.43 (m, 1H), 4.29-4.21 (m, 2H), 2.93 (s, 3H), 1.27 (t, 3H, $J = 4.23$ Hz).

^{13}C NMR: δ 184.9, 165.8, 163.6, 148.2, 142.9, 135.4, 134.1, 134.0, 133.3, 133.2, 132.6, 129.3, 129.1, 128.9, 123.3, 122.2, 122.1, 121.5, 118.4, 118.0, 115.1, 63.2, 51.5, 29.8, 14.0.

Mass spectrometric analysis (LRMS-FAB) m/z calcd for $\text{C}_{35}\text{H}_{27}\text{N}_2\text{O}_7\text{P}$ $[\text{M}+2\text{H}]^+$: 620.16, found: 620.51.

3-Cyano-3-carboxymethyl-4-oxo-2-*p*-trifluoromethyl-phenyl-5-(triphenyl- λ^5 -phosphanylidene)-cyclopent-1-ene carboxylic acid methyl ester **94**

To a solution of DMAD (63 mg, 0.44 mmol) and 4-trifluoromethyl phenyl cyanoacrylate **93** (63 mg, 0.29 mmol) was added triphenylphosphine (83 mg, 0.32 mmol) and stirred for 2 h. Usual processing of the reaction mixture afforded the phosphorane **94** as a yellow solid (115 mg, 62%), mp 219-220 $^\circ\text{C}$ (recrystallized from CH_2Cl_2 -hexanes).

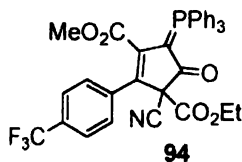

IR (KBr) ν_{\max} : 3062, 2933, 2861, 2237, 1738, 1645, 1609, 1578, 1547, 1444, 1413, 1326, 1207, 1114, 1073, 1022, 975 cm^{-1} .

^1H NMR: δ 7.78-7.71 (m, 6H), 7.67-7.62 (m, 3H), 7.57-7.48 (m, 8H), 7.38-7.35 (m, 2H), 4.25-4.15 (m, 2H), 2.88 (s, 3H), 1.19 (t, 3H, $J = 7.09$ Hz).

^{13}C NMR: δ 185.2, 166.1, 163.6, 142.3, 142.2, 137.5, 134.1, 134.0, 133.2, 133.1, 129.0, 128.9, 128.8, 128.5, 127.3, 125.2, 125.1, 125.0, 123.4, 122.1, 115.2, 65.4, 63.7, 63.5, 62.9, 60.2, 51.3, 29.8, 20.9, 14.2.

Mass spectrometric analysis (FAB) m/z calcd for $C_{36}H_{27}F_3NO_5P$ $[M+2H]^+$: 643.18, found: 643.04.

3,3-Dicyano-4-oxo-2-cinnamyl-5-(triphenyl- λ^5 -phosphanylidene)-cyclopent-1-ene carboxylic acid methyl ester **96**

To a solution of DMAD (63 mg, 0.44 mmol) and cinnamyl malononitrile **95** (52 mg, 0.29 mmol) was added triphenylphosphine (83 mg, 0.32 mmol) and stirred for 2 h. Usual processing of the reaction mixture afforded the phosphorane **96** as a yellow solid (72 mg, 45%), mp 215-216 °C (recrystallized from CH_2Cl_2 -hexanes).

IR (KBr) ν_{max} : 3056, 2953, 2222, 1743, 1665, 1604, 1532, 1439, 1372, 1289, 1212, 1150, 1063, 1011, 975 cm^{-1} .

1H NMR: δ 7.73-7.66 (m, 8H), 7.59-7.55 (m, 6H), 7.47-7.44 (m, 3H), 7.37-7.24 (m, 3H), 7.24-7.21 (m, 1H), 6.88-6.83 (m, 1H), 3.05 (s, 3H).

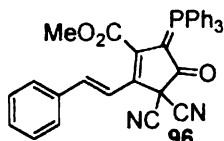

^{13}C NMR: δ 179.5, 163.7, 138.9, 134.1, 134.0, 133.8, 133.6, 132.1, 131.9, 131.8, 129.4, 129.2, 129.1, 128.9, 128.8, 128.6, 128.5, 128.3, 126.6, 123.7, 118.6, 112.4, 53.7, 53.2, 51.2, 29.8.

Mass spectrometric analysis (LRMS-FAB) m/z calcd for $C_{35}H_{25}N_2O_3P$ $[M+2H]^+$: 554.16, found: 554.14.

4-Hydroxy-3-nitro-2-(3,4-dichloro-phenyl)-5-(triphenyl- λ^5 -phosphanylidene)-cyclopenta-1,3 diene carboxylic acid methyl ester **98**

To a solution of DMAD (63 mg, 0.44 mmol) and 3,4-dichloro β -nitrostyrene **97** (66 mg, 0.29 mmol) was added triphenylphosphine (83 mg, 0.32 mmol) and stirred for 2 h. Usual processing of the reaction mixture afforded the phosphorane **98** as a yellow solid (113 mg, 66%), mp 171-172 °C (recrystallized from CH_2Cl_2 -hexanes).

IR (KBr) ν_{max} : 3361, 3062, 2953, 1728, 1670, 1550, 1438, 1301, 1209, 1114, 1020, 974 cm^{-1} .

1H NMR: δ 10.71 (s, 1H, D_2O exchangeable), 7.72-7.62 (m,

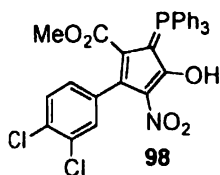

2.90 (s, 3H).

^{13}C NMR: δ 165.8, 159.7, 136.5, 134.0, 133.9, 133.2, 133.1, 132.2, 131.1, 130.6, 129.9, 129.2, 129.1, 129.0, 125.6, 124.4, 50.5, 29.9.

Mass spectrometric analysis (LRMS-FAB) m/z calcd for $\text{C}_{31}\text{H}_{22}\text{Cl}_2\text{NO}_5\text{P}$ $[\text{M}+2\text{H}]^+$: 591.06, found: 591.04.

4-Hydroxy-3-nitro-2-phenyl-5-(triphenyl- λ^5 -phosphanylidene)-cyclopenta-1,3 diene carboxylic acid methyl ester **100**

To a solution of DMAD (63 mg, 0.44 mmol) and β -nitrostyrene **99** (44 mg, 0.29 mmol) was added triphenylphosphine (83 mg, 0.32 mmol) and stirred for 2 h. Usual processing of the reaction mixture as described in the general procedure afforded the phosphorane **100** as a yellow solid (116 mg, 76%), mp 108-109 °C (recrystallized from CH_2Cl_2 -hexanes).

IR (KBr) ν_{max} : 3381, 3169, 3057, 2943, 1913, 1662, 1589, 1508, 1427, 1371, 1307, 1230, 1166, 1109, 1024, 943 cm^{-1} .

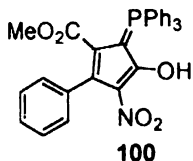

^1H NMR: δ 10.86 (s, 1H, D_2O exchangeable), 7.70-7.45 (m, 15H), 7.29-7.22 (m, 5H), 2.81 (s, 3H).

^{13}C NMR: δ 165.8, 159.7, 133.9, 133.7, 132.8, 132.7, 132.2, 132.1, 131.4, 131.3, 129.9, 129.2, 129.0, 128.8, 128.5, 127.7, 127.0, 124.6, 109.4, 60.4, 53.7, 50.2, 29.8.

4-Hydroxy-3-nitro-2-*p*-chloro-phenyl-5-(triphenyl- λ^5 -phosphanylidene)-cyclopenta-1,3 diene carboxylic acid methyl ester **102**

To a solution of DMAD (63 mg, 0.44 mmol) and 4-chloro β -nitrostyrene **101** (54 mg, 0.29 mmol) was added triphenylphosphine (83 mg, 0.32 mmol) and stirred for 2 h. Usual processing of the reaction mixture afforded the phosphorane **102** as a yellow solid (95 mg, 59%), mp 169-170 °C (recrystallized from CH_2Cl_2 -hexanes).

IR (KBr) ν_{\max} : 3397, 3067, 2953, 2923, 2856, 1712, 1671, 1557, 1465, 1439, 1382, 1300, 1207, 1114, 965 cm^{-1} .

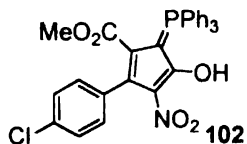

^1H NMR: δ 10.80 (s, 1H, D_2O exchangeable), 7.72-7.62 (m, 9H), 7.56-7.50 (m, 6H), 7.27-7.23 (m, 4H), 3.11 (s, 3H).

^{13}C NMR: δ 165.2, 159.6, 133.7, 132.8, 132.7, 132.6, 132.1, 132.0, 131.9, 131.3, 131.2, 128.8, 128.7, 128.5, 128.4, 128.3, 127.1, 124.3, 111.3, 109.4, 64.6, 53.7, 29.8.

4-Hydroxy-3-nitro-2-*p*-tolyl-5-(triphenyl- λ^5 -phosphanylidene)-cyclopenta-1,3 diene carboxylic acid methyl ester **104**

To a solution of DMAD (63 mg, 0.44 mmol) and 4-methyl β -nitrostyrene **103** (48 mg, 0.29 mmol) was added triphenylphosphine (83 mg, 0.32 mmol) and stirred for 2 h. Usual processing of the reaction mixture afforded the phosphorane **104** as a yellow solid (78 mg, 50%), mp 175-176 $^\circ\text{C}$ (recrystallized from CH_2Cl_2 -hexanes).

IR (KBr) ν_{\max} : 3381, 3067, 2948, 2912, 1712, 1666, 1563, 1527, 1418, 1382, 1295, 1207, 1114, 1022, 996 cm^{-1} .

^1H NMR: δ 10.93 (s, 1H, D_2O exchangeable), 7.72-7.60 (m, 9H), 7.54-7.48 (m, 6H), 7.24-7.20 (m, 2H), 7.13-7.10 (m, 2H), 2.84 (s, 3H), 2.36 (s, 3H).

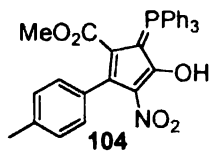

^{13}C NMR: δ 165.7, 159.6, 134.0, 132.7, 132.0, 131.9, 131.3, 130.4, 130.0, 129.6, 128.5, 128.5, 128.4, 128.3, 127.9, 127.5, 53.5, 29.8, 21.4.

Mass spectrometric analysis (LRMS-FAB) m/z calcd for $\text{C}_{32}\text{H}_{26}\text{NO}_5\text{P}$ $[\text{M}+2\text{H}]^+$: 537.15, found: 537.45.

4-Hydroxy-3-nitro-2-naphthyl-5-(triphenyl- λ^5 -phosphanylidene)-cyclopenta-1,3 diene carboxylic acid methyl ester **106**

To a solution of DMAD (63 mg, 0.44 mmol) and **105** (58 mg, 0.29 mmol) was added triphenylphosphine (83 mg, 0.32 mmol) and stirred for 2 h. Usual processing of

the reaction mixture afforded the phosphorane **106** as a yellow solid (68 mg, 41%), mp 176-177 °C (recrystallized from CH₂Cl₂-hexanes).

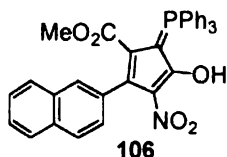

IR (KBr) ν_{\max} : 3371, 3049, 3003, 2949, 1714, 1678, 1554, 1514, 1427, 1384, 1328, 1290, 1209, 1039, 1008, 948 cm⁻¹.

¹H NMR: δ 10.82 (s, 1H, D₂O exchangeable), 7.77-7.36 (m, 22H), 2.65 (s, 3H).

¹³C NMR: δ 165.9, 159.8, 134.0, 133.9, 133.0, 132.9, 132.4, 132.2, 129.1, 128.9, 128.8, 128.6, 128.3, 127.2, 127.0, 125.9, 125.6, 125.1, 124.9, 50.3, 29.9.

Mass spectrometric analysis (LRMS-FAB) m/z calcd for C₃₅H₂₆NO₅P [M+2H]⁺: 573.15, found: 573.04.

4-Hydroxy-3-nitro-2-thienyl-5-(triphenyl- λ^5 -phosphanylidene)-cyclopenta-1,3 diene carboxylic acid methyl ester **108**

To a solution of DMAD (63 mg, 0.44 mmol) and **107** (45 mg, 0.29 mmol) was added triphenylphosphine (83 mg, 0.32 mmol) and stirred for 2 h. Usual processing of the reaction mixture afforded the phosphorane **108** as a yellow solid (35 mg, 23%), mp 173-174 °C (recrystallized from CH₂Cl₂-hexanes).

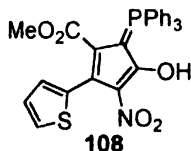

IR (KBr) ν_{\max} : 3361, 3071, 3014, 2929, 1712, 1658, 1555, 1534, 1429, 1374, 1308, 1270, 1219, 1019, 946 cm⁻¹.

¹H NMR: δ 10.83 (s, 1H, D₂O exchangeable), 7.73-7.62 (m, 10H), 7.55-7.53 (m, 4H), 7.31-7.29 (m, 2H), 7.01-6.97 (m, 2H), 2.92 (s, 3H).

¹³C NMR: δ 165.6, 159.5, 134.1, 133.9, 133.0, 132.7, 132.1, 132.0, 129.6, 128.7, 128.6, 128.4, 128.2, 127.1, 127.0, 125.7, 125.4, 125.1, 124.7, 50.2, 29.8.

Mass spectrometric analysis (LRMS-FAB) m/z calcd for C₂₉H₂₂NO₅PS [M+2H]⁺: 529.12, found: 529.15.

3,3-Dicyano-4-hydroxy-4-methoxy-5-oxo-2-*p*-tolyl-cyclopent-1-ene-carboxylic acid methyl ester **116**

To a solution of **76** (100 mg, 0.185 mmol) in dry methanol was added dropwise a solution of cerium(IV) ammonium nitrate (231 mg, 0.425 mmol) in methanol. The system was continuously purged with oxygen. The reaction mixture was allowed to stir at room temperature for 3 hours. After the phosphorane was completely consumed, the solvent was removed on a rotary evaporator and the residue was extracted with DCM and was washed with brine (2x10 mL). The combined organic extract was dried over anhydrous sodium sulphate and was subjected to column chromatography on silica gel (100-200 mesh). The oxidized product **116** was eluted using hexanes-ethyl acetate (70:30) solvent mixtures as a colourless liquid (35 mg, 57%).

IR (thin film) ν_{\max} : 3347, 2959, 2917, 2345, 2227, 1722, 1645, 1562, 1429, 1357, 1259, 1212, 1094, 1017 cm^{-1} .

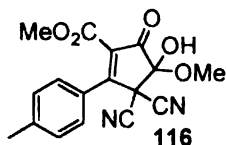

¹H NMR: δ 7.53-7.50 (m, 2H), 7.28-7.25 (m, 2H), 7.20 (s, 1H), 3.84 (s, 3H), 3.77 (s, 3H), 2.42 (s, 3H).

¹³C NMR: δ 180.9, 159.6, 143.9, 140.2, 132.7, 130.4, 129.7, 128.8, 113.2, 112.4, 104.7, 55.3, 53.6, 52.7, 21.6.

Mass spectrometric analysis (HRMS-EI) m/z calcd for $\text{C}_{17}\text{H}_{14}\text{N}_2\text{O}_5$: 326.0903, found: 326.0945.

2.8 References

1. a) Bohlmann, R. *In Comprehensive Organic Synthesis*; Eds: Trost, B. M and Fleming, I. *Vol.6*, Chapter 1.7, p-203. b) Sustmann, R. *In Comprehensive Organic Synthesis*; Eds: Trost, B. M and Fleming, I. *Vol.6*, Chapter 2.1, p-301. c) *Organic Phosphorus Compounds*; Eds: Kosolopoff, G. M.; Maier, L. Wiley, New York, 1973. d) Johnson, A. W. *Ylides and Imines of Phosphorus*, Chapter 1, p-1. John Wiley and sons, Inc. 1993.
2. a) Quinn, L. D. *A Guide to Organophosphorus Chemistry*, Wiley, New York, 2000. b) Valentine, D. H.; Hillhouse, J. H. *Synthesis* **2003**, 317.

3. a) Rauhut, M.; Currier, H (American Cyanamide Co.), *U.S. Patent 3,074*, 999, **1963**. *Chem Abstr.* **1963**, 58, 11224a. b) Mc Clure, J. D. *J. Org. Chem.* **1970**, 35, 3145.
4. Methot, J. L.; Roush, W. L. *Adv. Synth. Catal.* **2004**, 346, 1035.
5. a) Wang, L. -C.; Luis, A. L.; Agapiou, K.; Jang, H. -Y.; Krische, M. J. *J. Am. Chem. Soc.* **2002**, 124, 2402. b) Frank, S. A.; Mergott, D. J.; Roush, W. R. *J. Am. Chem. Soc.* **2002**, 124, 2404.
6. Morita, K.; Suzuki, Z.; Hirose, H. *Bull. Chem. Soc. Jpn.* **1968**, 41, 2815.
7. Baylis, A. B.; Hillman, M. E. D. *German Patent 2*, 155, 113, **1972**; *Chem Abstr.* **1972**, 77, 34174q.
8. a) Basavaiah, D.; Sharada, D. S.; Kumaragurubaran, N.; Reddy, R. M. *J. Org. Chem.* **2002**, 67, 7135. b) Basavaiah, D.; Reddy, R. M.; Kumaragurubaran, N.; Sharada, S. D. *Tetrahedron* **2002**, 58, 3693. c) Basavaiah, D.; Rao, J.; Satyanarayana, T. *Chem. Rev.* **2003**, 108, 811.
9. a) Roth, F.; Gygax, P.; Frater, G. *Tetrahedron Lett.* **1992**, 33, 1045. b) Brown, P. M.; Käppel, N.; Murphy, P. J. *Tetrahedron Lett.* **2002**, 43, 8707. c) Keck, G. E.; Welch, D. S. *Org. Lett.* **2002**, 4, 3687.
10. a) Huang, J. -W.; Shi, M. *Adv. Synth. Catal.* **2003**, 34, 953. b) Shi, M.; Chen, L. -H. *Chem. Commun.* **2003**, 1310.
11. Stewart, I. C.; Bergman, R. G.; Toste, F. D. *J. Am. Chem. Soc.* **2003**, 125, 8696.
12. Ma, D.; Lu, X. *Pure Appl. Chem.* **1990**, 62, 723.
13. a) Rychnovsky, S. D.; Kim, J. *J. Org. Chem.* **1994**, 59, 2659. b) Kazmaier, U. *Chem. Commun.* **1997**, 2305. c) Kazmaier, U. *Tetrahedron* **1998**, 54, 1491. d) Matsuo, K.; Sakaguchi, Y. *Heterocycles* **1996**, 43, 2553.
14. a) Trost, B. M.; Li, C. -J. *J. Am. Chem. Soc.* **1994**, 116, 3167. b) Trost, B. M.; Li, C. -J. *J. Am. Chem. Soc.* **1994**, 116, 10819. c) Trost, B. M.; Dake, G. R. *J. Org. Chem.* **1997**, 62, 5670.
15. Zhang, C.; Lu, X. *Synlett* **1995**, 645.

16. Lu, X.; Zhang, C.; Xu, Z. *Acc. Chem. Res.* **2001**, *34*, 535.
17. Ma, S. *Chem. Rev.* **2005**, *105*, 2829.
18. a) Zhang, C.; Lu, X. *J. Org. Chem.* **1995**, *60*, 2906. b) Xu, Z.; Lu, X. *Tetrahedron Lett.* **1997**, *38*, 3461. c) Xu, Z.; Lu, X. *J. Org. Chem.* **1998**, *63*, 5031.
19. a) Shu, L. -H.; Sun, W. -Q.; Zhang, D. W.; Wu, S. -H.; Wu, H. -M.; Xu, J. -F.; Lao, X. -F. *Chem. Commun.* **1997**, 79. b) Pyne, S. G.; Schafer, K.; Skelton, B. W.; White, A. H. *Chem. Commun.* **1997**, 2267. c) Xu, Z.; Lu, X. *J. Org. Chem.* **1998**, *63*, 5031.
20. Zhu, G.; Chen, Z.; Jiang, Q.; Xiao, D.; Cao, P.; Zhang, X. *J. Am. Chem. Soc.* **1997**, *119*, 3836.
21. Lu, X.; Lu, Z.; Zhang, X. *Tetrahedron* **2006**, *62*, 457.
22. Jean, L.; Marinetti, A. *Tetrahedron Lett.* **2006**, *47*, 2141.
23. Kumar, K.; Kapoor, R.; Kapur, A.; Ishar, M. P. S. *Org. Lett.* **2000**, *2*, 2023.
24. Kumar, K.; Kapur, A.; Ishar, M. P. S. *Org. Lett.* **2000**, *2*, 787.
25. Du, Y.; Lu, X.; Yu, Y. *J. Org. Chem.* **2002**, *67*, 8901.
26. Wilson, J. E.; Fu, G. C. *Angew. Chem., Int. Ed.* **2006**, *45*, 1426.
27. Lu, C.; Lu, X. *Org. Lett.* **2002**, *4*, 4677.
28. Wang, J.; Ng, S.; Krische, M. J. *J. Am. Chem. Soc.* **2003**, *125*, 3682.
29. a) Zhu, X.; Lan, J.; Kwon, O. *J. Am. Chem. Soc.* **2003**, *125*, 4716. b) Wurz, R. P.; Fu, G. C. *J. Am. Chem. Soc.* **2005**, *127*, 12234.
30. Tran, Y. S.; Kwon, O. *Org. Lett.* **2005**, *7*, 4289.
31. Du, Y.; Lu, X.; Zhang, C. *Angew. Chem., Int. Ed.* **2003**, *42*, 1035.
32. Du, Y.; Feng, J.; Lu, X. *Org. Lett.* **2005**, *7*, 1987.
33. a) Zhu, X. -F.; Henry, C. E.; Wang, J.; Dudding, T.; Kwon, O. *Org. Lett.* **2005**, *7*, 1387. b) Zhu, X. -F.; Schaffner, A. -P.; Li, R. C.; Kwon, O. *Org. Lett.* **2005**, *7*, 2977.
34. a) Horner, L.; Hoffmann, H. *Angew. Chem.* **1956**, *48*, 473. b) Winterfeldt, E. *Angew. Chem., Int. Ed.* **1967**, *6*, 423.

34. a) Horner, L.; Hoffmann, H. *Angew. Chem.* **1956**, *48*, 473. b) Winterfeldt, E. *Angew. Chem., Int. Ed.* **1967**, *6*, 423.
35. Winterfeldt, E.; Dillinger, H. -J. *Chem. Ber.* **1966**, *99*, 1558.
36. Nozaki, K.; Sato, N.; Ikeda, K.; Takaya, H. *J. Org. Chem.* **1996**, *61*, 4516.
37. a) Nair, V.; Nair, J. S.; Vinod, A. U.; Rath, N. P. *J. Chem. Soc., Perkin Trans. 1* **1997**, 3129. b) Nair, V.; Nair, J. S.; Vinod, A. U. *Synthesis* **2000**, 1713.
38. Xu, Z.; Lu, X. *J. Org. Chem.* **1998**, *63*, 5031.
39. Brunn, E.; Huisgen, R. *Angew. Chem., Int. Ed. Engl.* **1969**, *8*, 573.
40. Mitsunobu, O. *Synthesis* **1981**, 1.
41. Girard, M.; Murphy, P.; Tsou, N. *Tetrahedron Lett.* **2005**, *46*, 2449.
42. Liu, Y.; Xu, C.; Liu, L. *Synthesis* **2003**, 1335.
43. Otte, R. D.; Sakata, T.; Guzei, I. A.; Lee, D. *Org. Lett.* **2005**, *7*, 495.
44. Nair, V.; Biju, A. T.; Abhilash, K. G.; Menon, R. S.; Suresh, E. *Org. Lett.* **2005**, *7*, 2121.
45. Nair, V.; Biju, A. T.; Vinod, A. U.; Suresh, E. *Org. Lett.* **2005**, *7*, 5139.
46. Yavari, I.; Hekmat-Shoer, R.; Zonousi, A. *Tetrahedron Lett.* **1998**, *39*, 2391.
47. Yavari, I.; Bayat, M. *Tetrahedron* **2003**, *59*, 2001.
48. Jung, C.; Wang, J.; Krische, M. J. *J. Am. Chem. Soc.* **2004**, *126*, 4118.
49. Nair, V.; Rajesh, C.; Vinod, A. U.; Bindu, S.; Sreekanth, A. R.; Mathen, J. S.; Balagopal, L. *Acc. Chem. Res.* **2003**, *36*, 899.
50. Ramirez, F.; Levy, S. *J. Am. Chem. Soc.* **1957**, *79*, 61.

The Reaction of Dimethoxycarbene-DMAD Zwitterion with 1,2-Diones - Synthesis of Dihydrofurans and Spirodihydrofurans

3.1 Introduction

Nucleophilic carbenes have attracted considerable attention in recent years due to their versatile chemistry and potential applications in organic synthesis.¹ Of these, the diamino- and dialkoxy-substituted carbenes are the most extensively studied group of carbenes. The present chapter describes a new multicomponent reaction (MCR) based on the reactivity of dimethoxycarbene-dimethyl acetylenedicarboxylate (DMAD) zwitterion with 1,2-dicarbonyl compounds. Before going into the details, a brief overview of the generation and reactivity patterns of dialkoxycarbenes is described in the following sections.

3.2 Dialkoxycarbenes

Dialkoxycarbenes are species having two oxygen atoms directly attached to the carbene carbon. These have singlet ground states as a consequence of donation of the lone-pair on the alkoxy oxygen atom into the formally vacant *p*-orbital of the carbene carbon (Chapter 1, Scheme 43). This kind of electronic delocalization not only stabilizes the ground state,² but also the transition states and the dipolar intermediates arising from the reactions of the carbene and renders it nucleophilic.³ The various methods for the generation of dialkoxycarbenes are outlined below.

3.2.1 Generation of dialkoxycarbenes

Dialkoxycarbenes were first generated by Hoffmann in 1971 by the thermolysis of norbornadiene ketals. This method, however, is limited to the preparation of only a few alkoxy carbenes and is unsuitable for unsymmetrical carbenes (Scheme 1).⁴

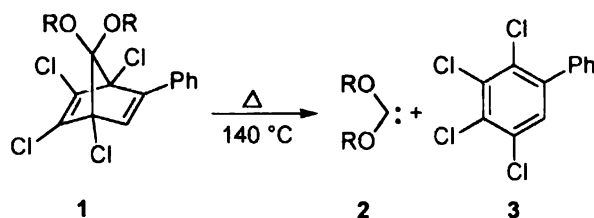

Scheme 1

Later, Moss and co-workers showed that dimethoxycarbene could be photochemically or thermally generated from dimethoxy diazirine. The latter is prepared by the reaction of methoxychloro diazirine with sodium methoxide in DMF (Scheme 2).⁵ However, this method is also not very useful for synthetic applications because the explosive diazirines are generally available only as dilute solutions in solvents such as pentane.

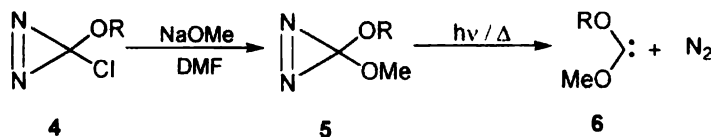

Scheme 2

Warkentin in 1992, identified 2,2-dimethoxy-5,5-dimethyl- Δ^3 -1,3,4-oxadiazoline **10** as a shelf stable, thermal source of dimethoxycarbene.^{6,7} Since then, this method has been the most useful one for the generation of dialkoxy and other heteroatom substituted carbenes. These carbene precursors are easily accessible by the oxidation of alkoxy carbonyl hydrazones of acetone with lead tetraacetate (LTA)⁸ or phenyl iodonium acetate.⁹ Electrochemical oxidation of ketone hydrazones to oxadiazolines is also known.¹⁰ The LTA oxidation affords a mixture of 2-acetoxy-2-methoxy-5,5-dimethyl- Δ^3 -1,3,4-oxadiazoline **8** and an acyclic azo compound **9**, which on acid catalyzed displacement reaction with a suitable alcohol affords the required oxadiazoline **10** along with unchanged **9**. Selective removal of the latter is achieved by hydrolysis with aqueous base. The advantage of this method is that a single acetoxy substrate **8** can serve as the source of different oxadiazolines (Scheme 3).¹¹

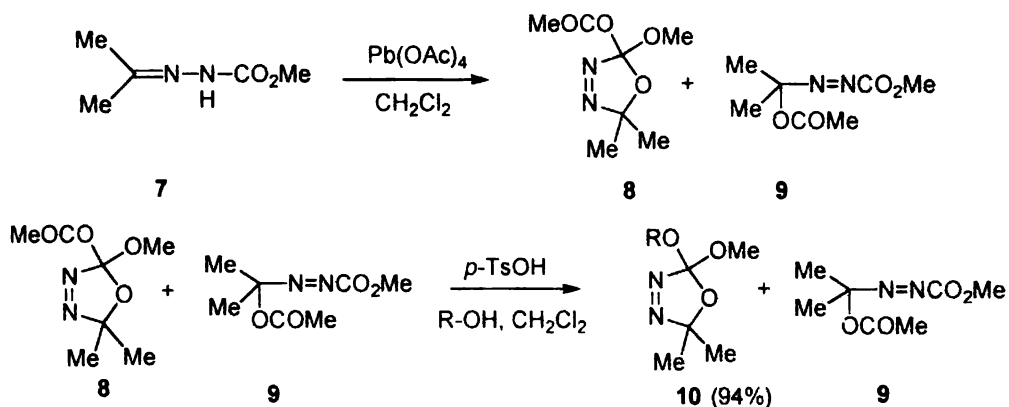

Scheme 3

The oxadiazoline **10** undergoes thermolysis at *ca* 100 °C in solution to afford the corresponding dialkoxycarbenes. The carbonyl ylide **12**, formed by the initial decomposition of oxadiazoline, undergoes successive fragmentation to the corresponding singlet carbene (Scheme 4).

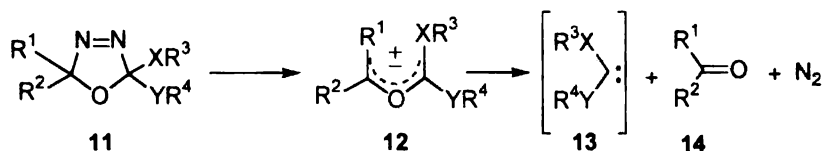

Scheme 4

Very recently, Warkentin has reported the generation of dimethoxycarbene **16** at 40-50 °C by the thermolysis of 2,5-dihydro-2,2-dimethoxy-5-methyl-5-(*p*-methoxy)phenyl-1,3,4-oxadiazole **15** (Scheme 5).¹² The lower temperature of this reaction permits the isolation of products that might not survive at 100 °C.

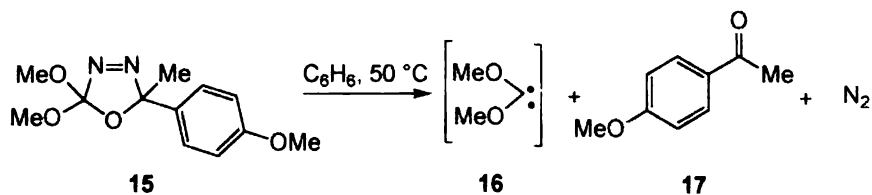

Scheme 5

The chemistry of dialkoxycarbene, especially dimethoxycarbene, was the subject of extensive investigations by Hoffmann and later by Warkentin. a brief account of which is given in the following passages.

3.2.2 Reactions of dialkoxycarbene

Hoffmann studied the reactivity of dimethoxycarbene towards electron-deficient alkenes and demonstrated that the carbene undergoes insertion to form cyclopropane derivatives as shown below. The retention of stereochemistry observed in the reaction of dimethoxycarbene with olefins is diagnostic of its singlet ground state (Scheme 6).¹³

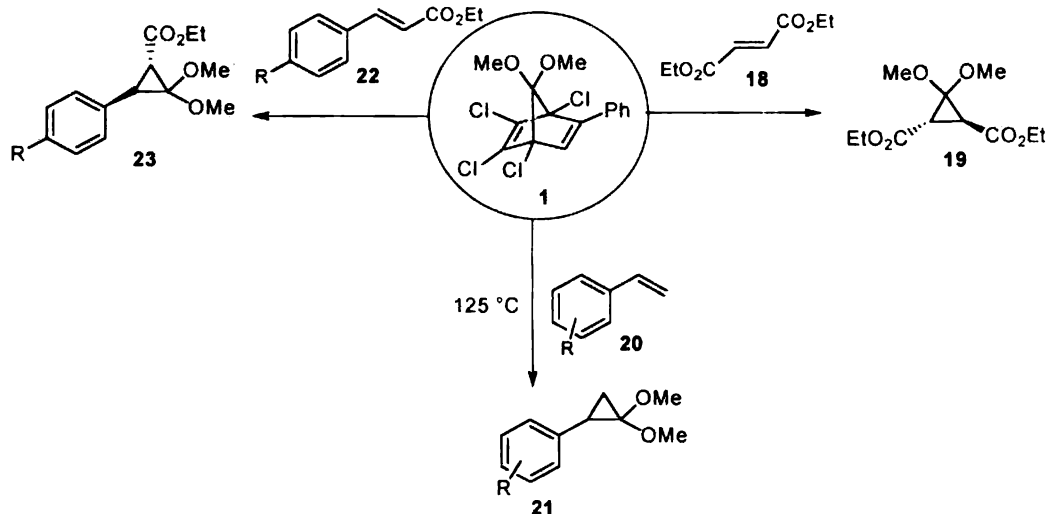

Scheme 6

Recent studies, however, have shown that the reactivity of the dialkoxycarbene towards electron-deficient alkenes largely depends on the method of their generation. For example, Warkentin has demonstrated that dimethoxycarbene generated from the oxadiazoline **15** at 50 °C in benzene reacts with dimethyl dicyanofumarate **24** to form the zwitterionic intermediate **25** which in turn can react with another molecule of dimethoxycarbene to yield products such as **26** and **27** (Scheme 7).¹²

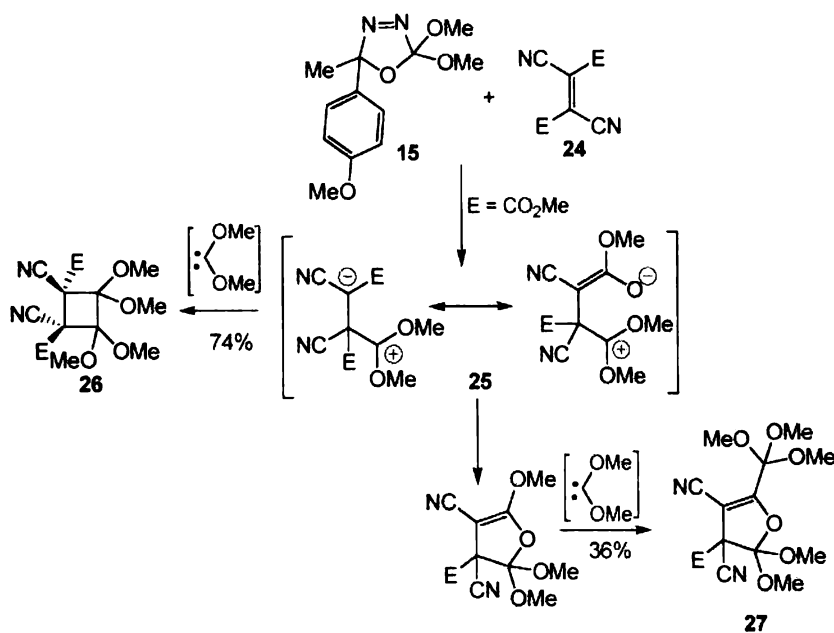

Scheme 7

Reaction of dimethoxycarbene with electron-deficient alkynes to afford 1:2 adducts has already been described in chapter 1, scheme 44 of this thesis. Formation of similar 1:2 adducts was observed by Hoffmann with heterocumulenes like aryl isocyanates and aryl isothiocyanates **36** (resulting in the formation of substituted hydantoins and thiohydantoins),¹⁴ aryl acetylenes **30**, diphenyl ketene **32**¹³ and 2,3-butanedione **34**¹⁵ as shown below. In all these cases dimethoxycarbene generated from **1** reacts with one molecule of the electrophile to form a 1,3-dipolar intermediate which then adds on to another molecule of the electrophile followed by ring closure to give the 1:2 adduct (Scheme 8).

The 1:2 adduct formation between dimethoxycarbene and dimethyl acetylenedicarboxylate has been exploited in our laboratory for the construction of a variety of heterocyclic and carbocyclic systems, the details of which are given in this chapter.

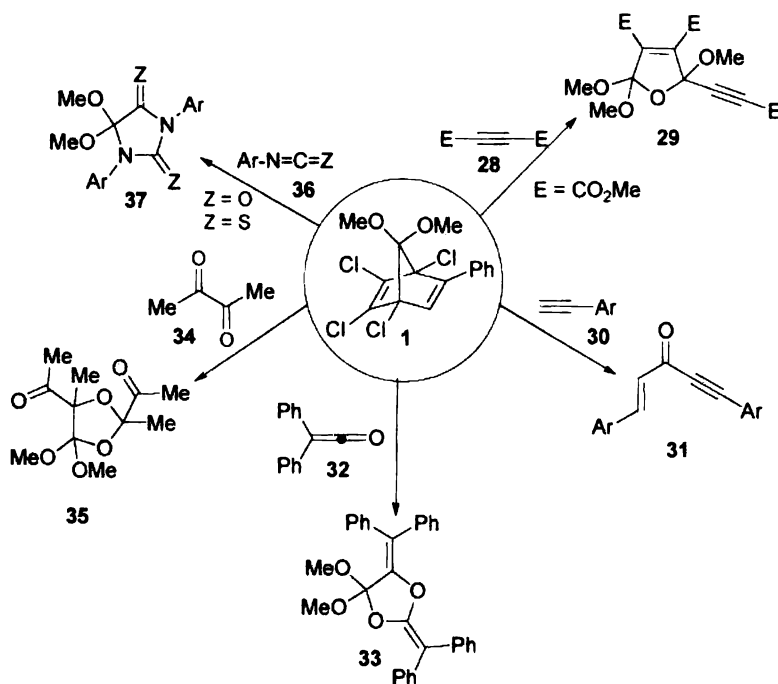

Scheme 8

Dimethoxycarbene can react in different ways with the carbonyl group. For example, it undergoes nucleophilic addition to the carbonyl groups of acid chlorides¹³ and cyclic anhydrides¹⁶ to form dipolar intermediates which can rearrange to form the final product (Scheme 9).

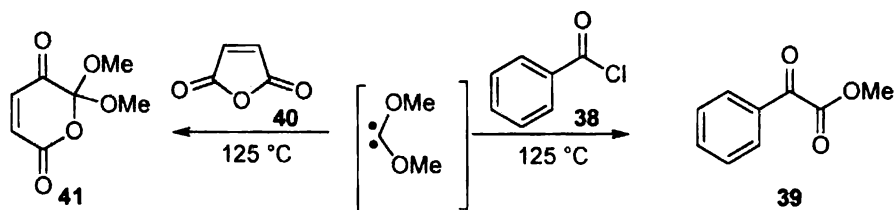

Scheme 9

A different kind of reactivity was observed by Warkentin with 9-fluorenone **43** and adamantane thione **46** leading to the formation of dialkoxyoxiranes and thiiranes respectively (Scheme 10).¹⁷

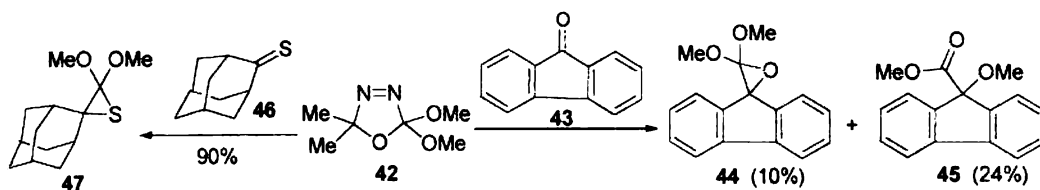

Scheme 10

1,3-Dicarbonyl compounds were also found to undergo reaction with dimethoxycarbene resulting in the formation of an inserted product and the alkene formed by methanol elimination. Related insertions into alcohols and phenols afford the corresponding orthoformates (Scheme 11).¹⁸

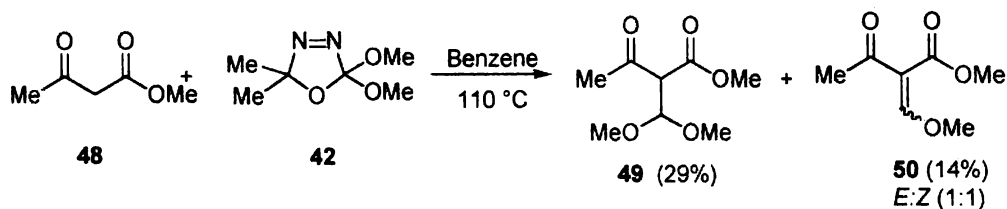

Scheme 11

Dimethoxycarbene was also found to react with quinonoid compounds such as *p*-chloranil to afford products resulting from the nucleophilic addition of the carbene to the carbonyl group (Scheme 12).¹⁹

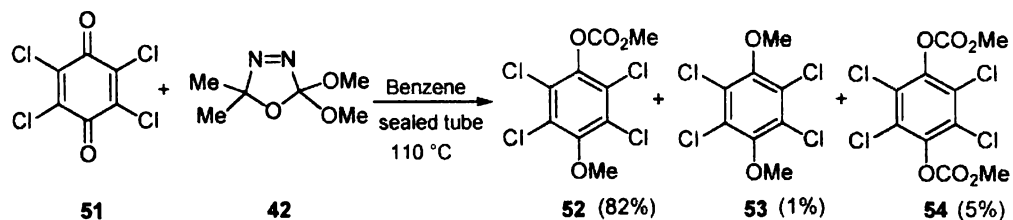

Scheme 12

Another class of reactions in which dimethoxycarbene is known to participate efficiently is the [4+1] cycloaddition reaction. Hoffmann and Lilienblum in 1977 observed an intramolecular cheletropic elimination reaction between dimethoxycarbene and tetracyclone 55 leading to the formation of the product 56 (Scheme 13).²⁰ This reaction seems to be the first example of [4+1] cycloaddition of dimethoxycarbene.

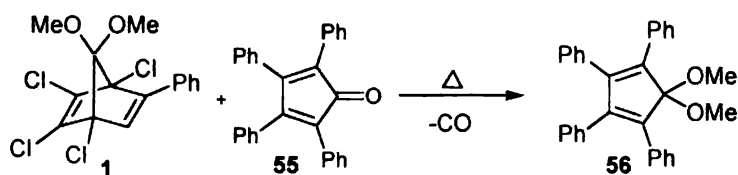

Scheme 13

Dimethoxycarbene generated from **1** has been intercepted with tetrazines to afford the corresponding pyrazole **59** via the [4+1] cycloaddition of the carbene followed by subsequent cycloreversion as shown below (Scheme 14).²¹

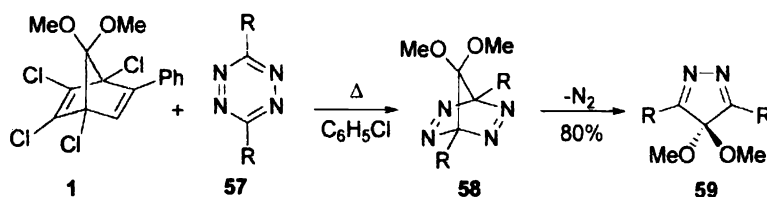

Scheme 14

[4+1] cycloaddition of dimethoxycarbene with the bisketene generated by the thermolysis of cyclobutenedione **60** has led to the formation of cyclopentenedione derivative **62** (Scheme 15).²²

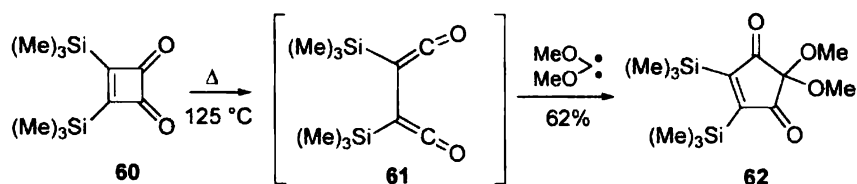

Scheme 15

Rigby reported the [4+1] cycloaddition of dialkoxycarbenes to vinyl isocyanates and vinyl ketenes leading to the formation of hydroindolones and highly substituted cyclopentenones respectively (Scheme 16).^{23, 24}

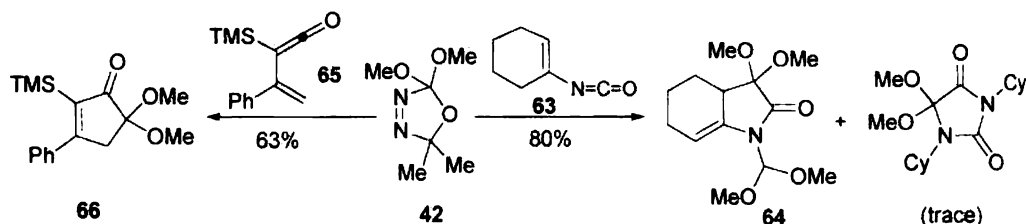

Scheme 16

In the formation of **64**, it is presumed that addition of the second equivalent of the carbene occurs *via* a fast NH insertion subsequent to ring formation. Both these types of cycloadditions are general for oxygen, nitrogen and sulfur based nucleophilic carbenes.

Very recently inter- and intramolecular [4+1] cycloadditions between electron-deficient dienes and dialkoxycarbenes were reported by Spino and co-workers. The reactions led to formation of the corresponding cyclopentene derivatives in low yields (Scheme 17).²⁵

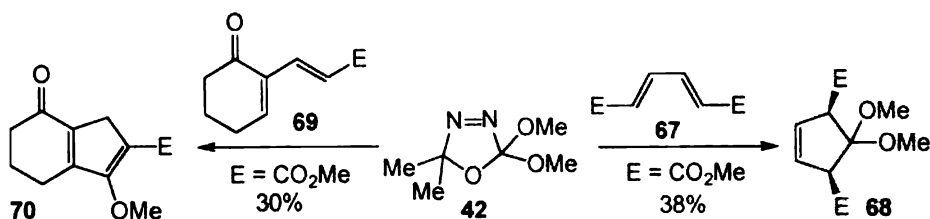

Scheme 17

Dienes tethered to oxadiazoline, on thermolysis gave good yields of bicyclic adducts as shown below. [4+1] annulation was possible with enone **73** to give the bicyclic orthoester **74** in 82% isolated yield (Scheme 18).²⁵

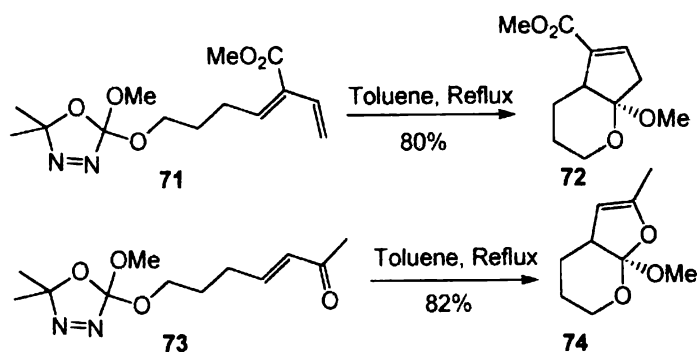

Scheme 18

Thermolysis of other dialkoxy substituted oxadiazolines was also studied by Warkentin. For example, thermolysis of oxadiazoline substituted with alkyne functionality **75** underwent an interesting rearrangement to furnish the tricyclic product **77** in good yield (Scheme 19).²⁶

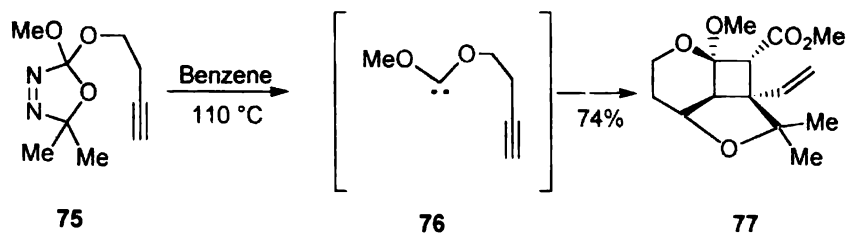

Scheme 19

The bis-oxadiazoline **78** on thermolysis in presence of DMAD afforded the benzofused tricyclic compound **80** in moderate yield (Scheme 20).²⁷

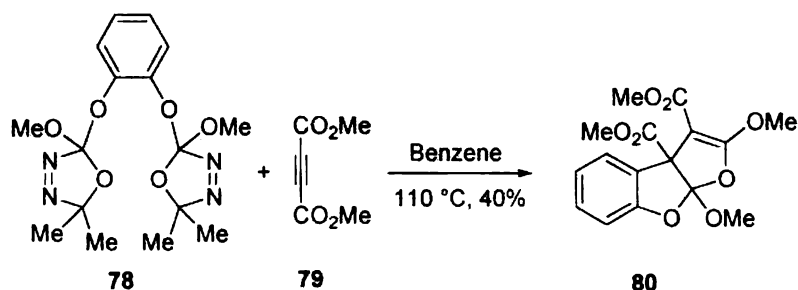

Scheme 20

Warkentin observed that the thermolysis of 2-cinnamyloxy-2-methoxy-5,5-dimethyl- Δ^3 -1,3,4-oxadiazoline **81** afforded the products **85** and **86** via a β -scission of the carbene formed as shown in the scheme below (Scheme 21).²⁸

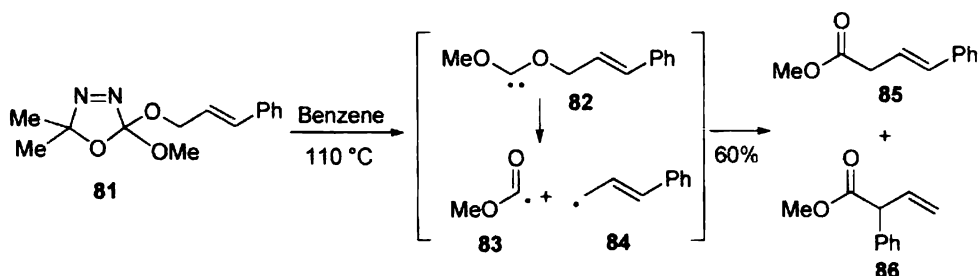

Scheme 21

Very recently the same group has studied the temperature dependence of the reactions of allyloxy(methoxy) carbene in solution. It was observed that at 50 °C. fragmentation to a radical pair is not important but the carbene tends to undergo

dimerization followed by a Claisen rearrangement to afford **89** in major amounts as illustrated below (Scheme 22).²⁹

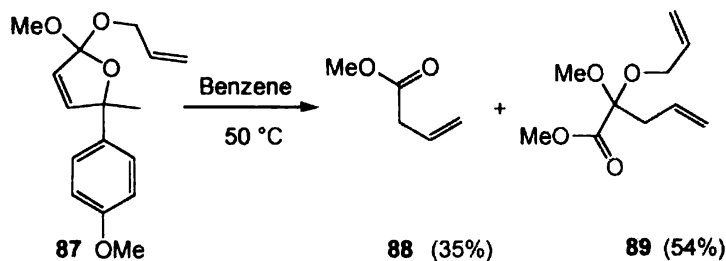

Scheme 22

Work in our laboratory has shown that the zwitterion formed from dimethoxycarbene and DMAD can react with electrophilic compounds like aldehydes and electron-deficient styrenes to form dihydrofurans and cyclopentenone derivatives respectively (Scheme 23).³⁰

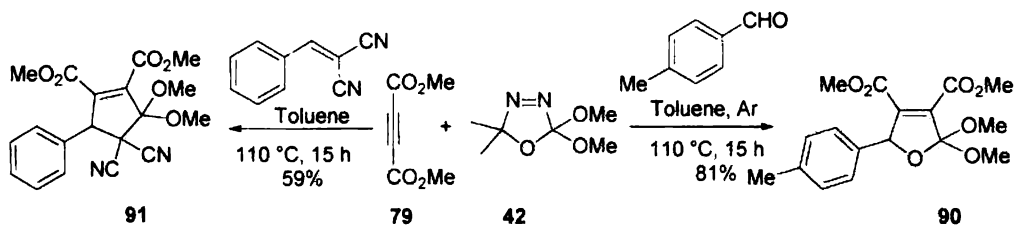

Scheme 23

The zwitterion was also found to react efficiently with 1,4-dienones to yield divinyl dihydrofuran which in turn underwent an interrupted Nazarov reaction to yield bicyclic lactones such as **94** (Scheme 24).³¹

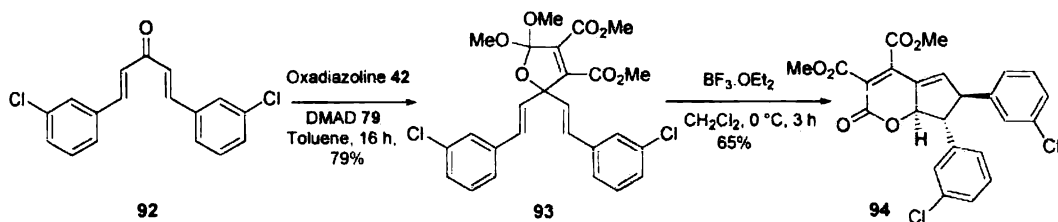

Scheme 24

As the present study is concerned with the addition of the dimethoxycarbene-DMAD zwitterion to 1,2-dicarbonyl compounds like diaryl 1,2-diones, isatins and

cyclobutenediones, a brief introduction to the latter two species with emphasis on their dipolar cycloaddition reactions is presented in the following section.

3.3 Isatins and Cyclobutenediones

Isatins are a class of versatile substrates which can be used for the synthesis of a large variety of pharmacologically important compounds.³² They have been found in the mammalian tissues and serve as a modulator in many biochemical processes.³³ There are many methods for the synthesis of isatins and their N-alkylated derivatives, among which the reaction of alkyl halide in DMF in presence of calcium hydride as a base is the most convenient one for the preparation of N-alkyl isatins.³⁴ Isatin is also an important raw material for drug synthesis, for example in the synthesis of the analgesic drug pemedolac, the key intermediate is formed by the alkylation of isatin at C-3 followed by reduction with LAH (Scheme 25).³⁵

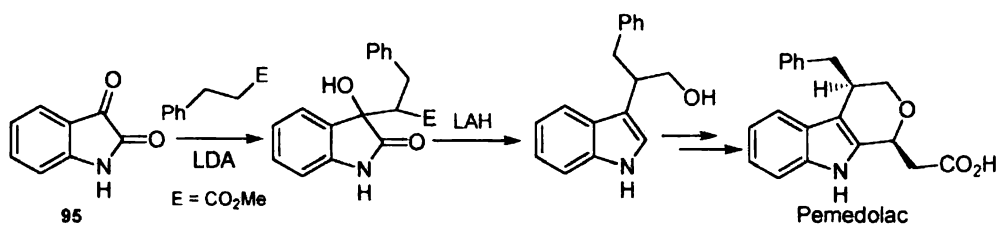

Scheme 25

Work in our laboratory has shown that the carbonyl group of isatins can act as versatile 2π -component and can undergo a variety of [3+2] cycloadditions leading to spirooxindole derivatives.³⁶ The scheme below summarizes the results in this area. Both cyclic and acyclic carbonyl ylides underwent facile cycloaddition with the carbonyl group of isatin to afford products **98** and **99** respectively. Azomethine ylide generated from **102** also reacted with isatin to form the cycloadduct **103**. Nucleophilic addition of allyl triisopropylsilane **100** to the Lewis acid co-ordinated keto carbonyl of isatin afforded the product **101** (Scheme 26). In all cases the 1,3-dipole reacts with the more electrophilic carbonyl of the isatin to generate the spirooxindole derivatives. Spirooxindole is a common motif of alkaloids with significant biological activity.

In addition to these, the azomethine ylide generated by the reaction of isatin with α -amino acids has been intercepted with electrophilic carbon-carbon^{37a,b} and carbon-oxygen double bonds to yield spiropyrrolidines.^{37c}

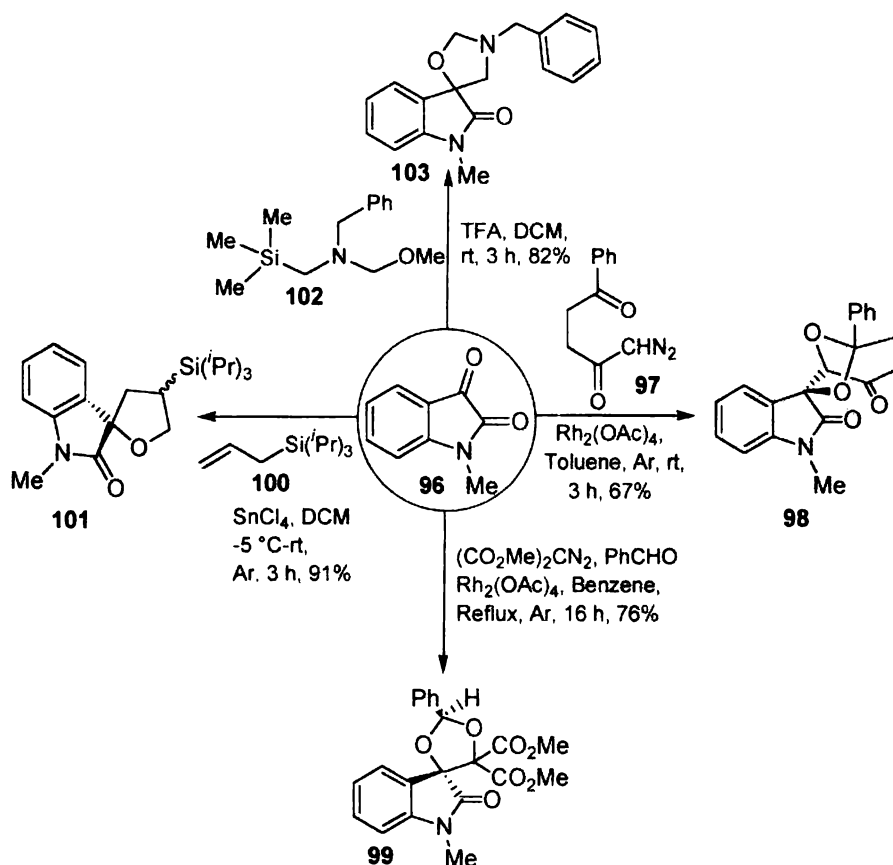

Scheme 26

The addition of unconventional dipoles or zwitterions to isatins has also been utilized to afford a variety of heterocyclic spirooxindole derivatives as shown below. The spirooxadiazoline **107** is formed by the reaction of triphenylphosphine-DEAD zwitterion with isatins. The addition of isocyanide-DMAD zwitterion led to the formation of spiroiminolactone **104** while the addition of pyridine-DMAD zwitterion to isatin resulted in the formation of the spirooxindole derivative **106**. Similar reaction with isoquinoline-DMAD zwitterion resulted in the formation of the product **105** (Scheme 27).³⁸

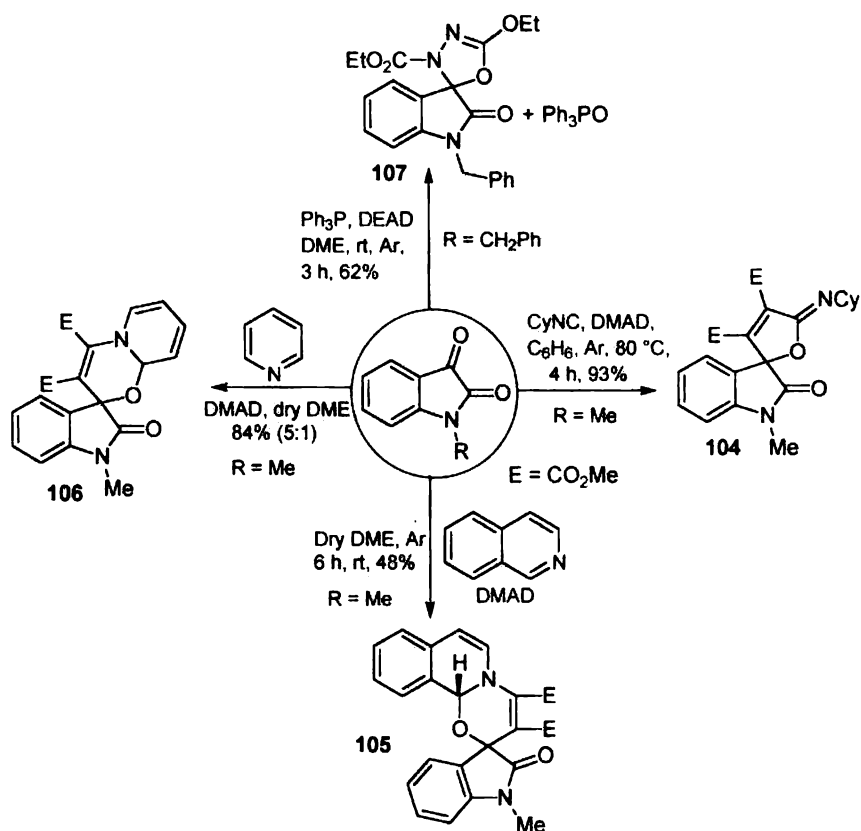

Scheme 27

Another versatile class of 1,2-dicarbonyl compounds are the cyclobutene 1,2-diones. During the last two decades a variety of simple and powerful methods have been developed for the conversion of cyclobutenediones into highly functionalized molecules of synthetic importance.³⁹ The following section will highlight the dipolar cycloaddition reactions in which these species participate.

Cyclobutenediones have been shown to react with excess of diazomethane to give cycloadducts as shown below (Scheme 28).⁴⁰

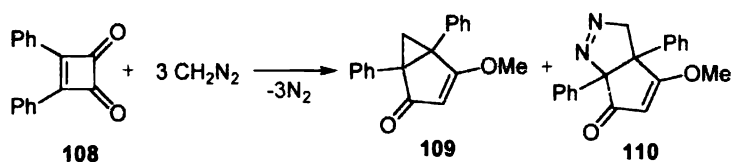

Scheme 28

Cyclobutenediones, despite their weak dipolarophilic behaviour towards benzonitrile oxide, on prolonged heating (30-40 h) with excess of mesitronitrile oxide **111**, afforded mono, bis and tris adducts (Scheme 29).⁴¹ Interestingly the dipole preferentially attacks the carbonyl dipolarophile.

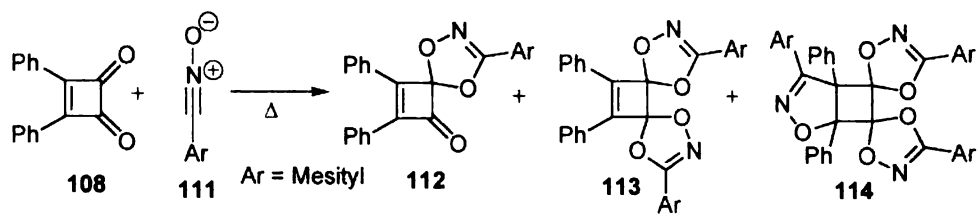

Scheme 29

Investigations in our laboratory have shown that azomethine ylide generated by decarboxylative condensation of sarcosine **115** with N-methylisatin **96** adds to cyclobutenedione **108** to afford the spiropyrrolidine derivative **116** (Scheme 30).^{37c}

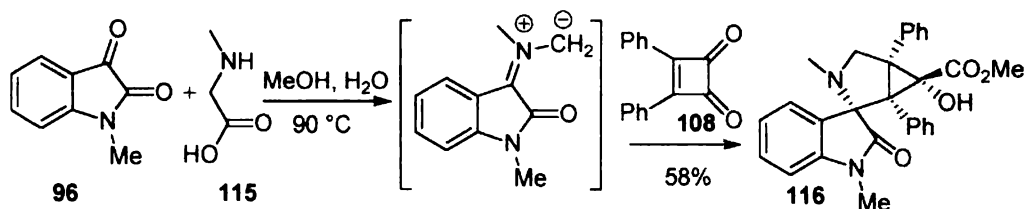

Scheme 30

Recent work in our laboratory has demonstrated that zwitterions generated from pyridine and DMAD as well as isocyanide and DMAD can add to one of the carbonyl groups of the cyclobutenedione to yield highly substituted benzene derivatives and spiropyran derivatives respectively. While the first reaction takes place by the addition of the pyridine-DMAD zwitterion to the carbonyl group of the dione followed by ring opening and rearrangement, the latter occurs *via* a pseudo four-component reaction of the isocyanide-DMAD zwitterion with the carbonyl group. An illustrative example is shown below (Scheme 31).⁴²

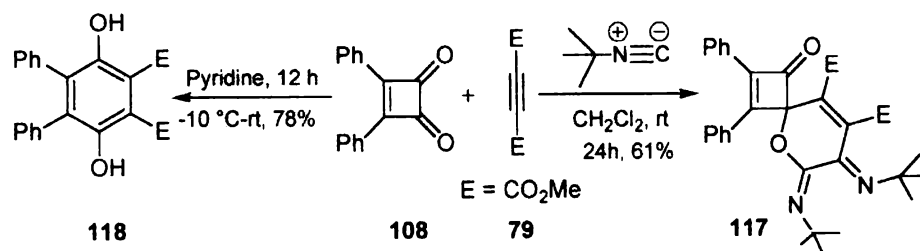

Scheme 31

3.4 Statement of the Problem

The carbonyl group of 1,2-dicarbonyl compounds is a potentially reactive functional moiety mainly due to the inherent coulombic repulsion between the adjacent carbonyls. In view of the sustained interest in the area of nucleophilic carbenes and the quest to develop new multicomponent methodologies for heterocyclic synthesis, we have explored the reactivity pattern of 1,2-dicarbonyl compounds like diaryl 1,2-diones, cyclobutenediones and N-substituted isatins towards the 1,3-dipolar species generated by the addition of dimethoxycarbene to DMAD. The results obtained are discussed in the following sections.

3.5 Results and Discussions

The diaryl 1,2-diones, except *m*-dinitrobenzil, required for our studies were prepared by the base catalyzed reaction of the corresponding aldehydes with thiamine hydrochloride as catalyst followed by oxidation of the resulting benzoin using concentrated nitric acid (Scheme 32).⁴³

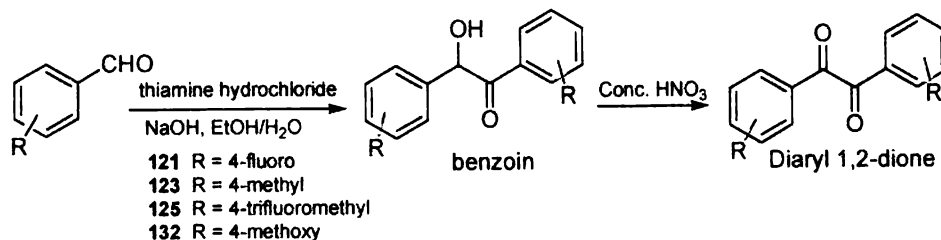

Scheme 32

The diaryl 1,2-diones were obtained in moderate yields. These were purified to remove the trace amount of carboxylic acid by column chromatography on silica gel.

The *m*-dinitrobenzil required for our studies was prepared by the nitration of benzil using the conventional nitration procedure.

In our initial experiment, we exposed benzil **119** to the zwitterionic species generated from DMAD **79** and dimethoxycarbene, the latter being generated *in situ* by the thermolysis of the oxadiazoline **42** in dry toluene in a sealed tube for 24 h. Concentration of the reaction mixture followed by column chromatography of the residue on silica gel using hexanes-ethyl acetate solvent mixture (80:20) afforded the product **120** in 83% yield (Scheme 33).

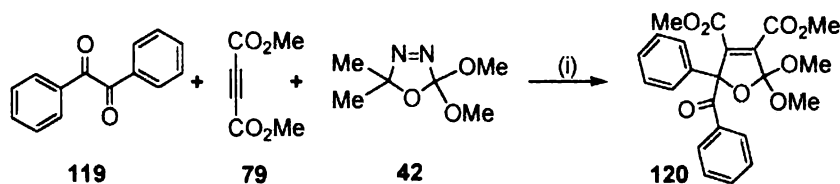

(i) Toluene, sealed tube, 110 °C, 24 h, 83%

Scheme 33

The structure of the product **120** was established by spectroscopic analysis. In the IR spectrum of **120** the vibrational stretching of the ester and benzoyl carbonyl groups were discernible at 1743 and 1686 cm^{-1} respectively. In the ^1H NMR spectrum, the methoxy protons resonated as sharp singlets at δ 3.68 and 3.06 while the protons of the carbomethoxy groups resonated at δ 3.83 and 3.73. The ^{13}C NMR spectrum displayed the characteristic signal for the ester and benzoyl carbonyl carbons at δ 167.9, 167.3 and 192.3 respectively. The compound gave satisfactory mass spectral analysis also.

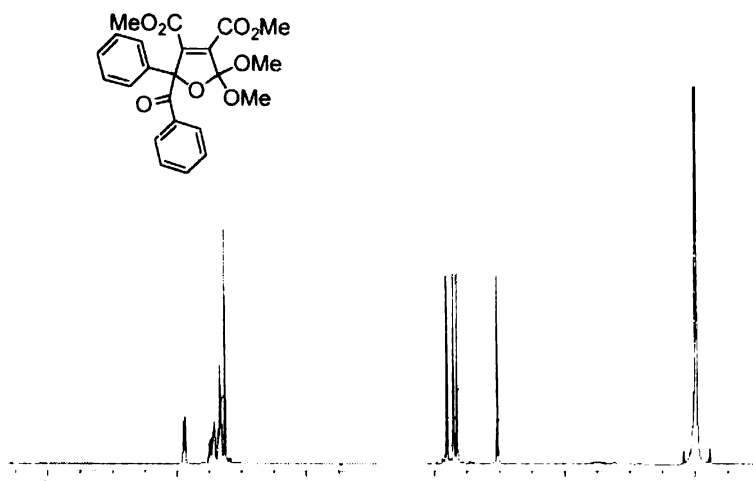

Figure 1 ^1H NMR spectrum of compound **120**

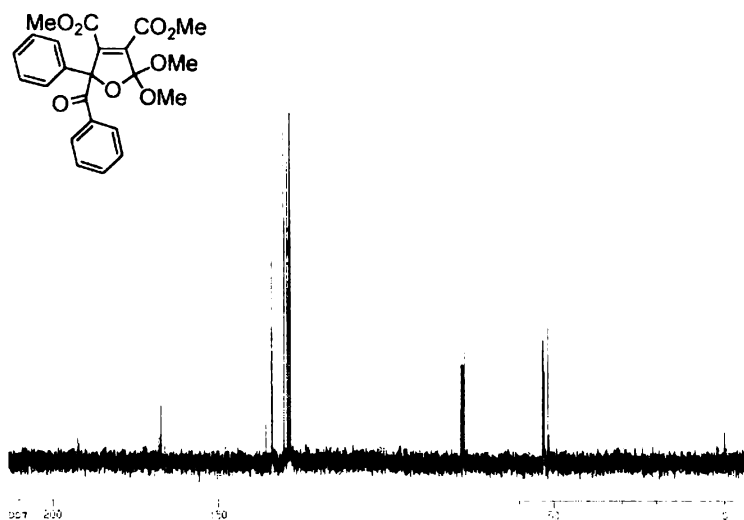

Figure 2 ^{13}C NMR spectrum of compound **120**

Final confirmation of the structure of **120** was obtained from single crystal X-ray analysis (Figure 3).

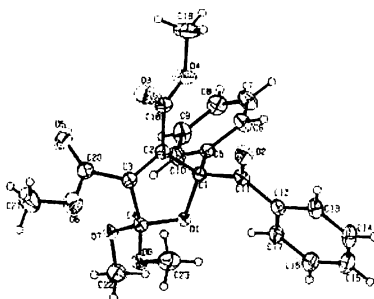
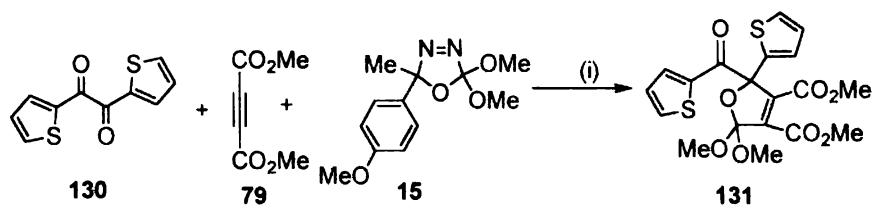

Figure 3 Single crystal X-ray structure of **120**

The reaction was found to be general with a number of diaryl 1,2-diones and the results are summarized in table 1. It is noteworthy that highly electron deficient diaryl diones **125** and **128** (entries 3 and 4) underwent a carbene insertion followed by rearrangement to yield the products **127** and **129** in major amounts while highly electron-rich 4,4'-dimethoxy diaryl dione **132** did not undergo any reaction (entry 5, Table 1).

The reaction of thenil **130** with DMAD and dimethoxycarbene was found to be temperature dependant. Treatment of thenil **130** with DMAD **79** and oxadiazoline **42** under the usual reaction conditions led to the formation of the dihydrofuran **131** in only 15% yield. However, when oxadiazoline **15**, known to generate the carbene at 50 °C, was used in place of **42** the product **131** was formed in 71% yield (Scheme 34).



(i) Benzene, sealed tube, 50 °C, 24 h, 71%

Scheme 34

Table 1

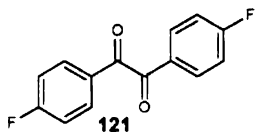
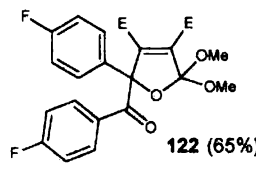
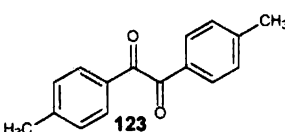
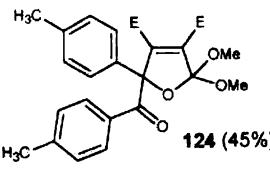
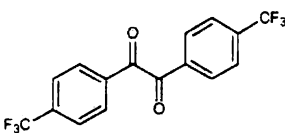
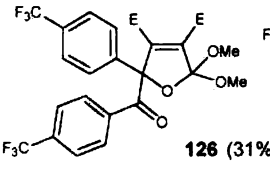
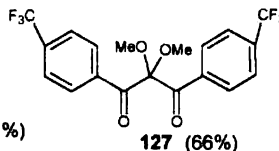
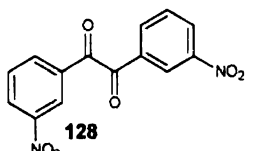
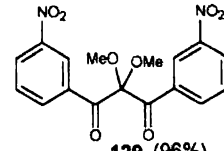
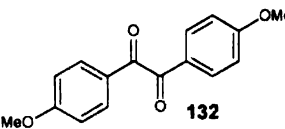
Entry	Substrate	Dihydrofuran	Inserted Product
1	 121	 122 (65%)	(0)
2	 123	 124 (45%)	(0)
3	 125	 126 (31%)	 127 (66%)
4	 128	(0)	 129 (96%)
5	 132	(0)	(0)

Reaction conditions: Oxadiazoline (2 equiv), DMAD (1.5 equiv), Dry Toluene, Sealed tube, 24 h

Mechanistically, it is conceivable that the zwitterionic intermediate **I** initially formed by the 1:1 interaction of dimethoxycarbene **16** and DMAD **79** adds to one of the carbonyl groups of the dione leading to a new zwitterionic species **II** and cyclization of the latter yields the dihydrofuran product **120**. Alternatively, a cycloaddition of the zwitterion with the C=O can also lead to the dihydrofuran (Scheme 35).

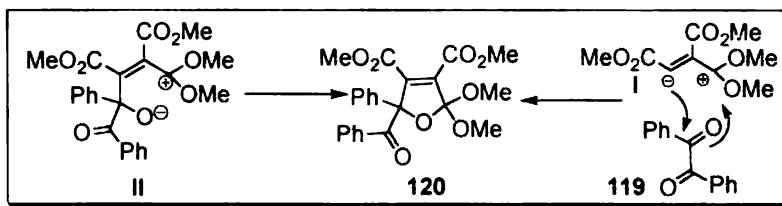

Scheme 35

Subsequently the reaction of the zwitterion, I with 3,4 diaryl cyclobutene-1,2-diones was investigated. The cyclobutenediones required for our studies were prepared by a reported protocol⁴⁴ starting from commercially available squaric acid (Scheme 36).

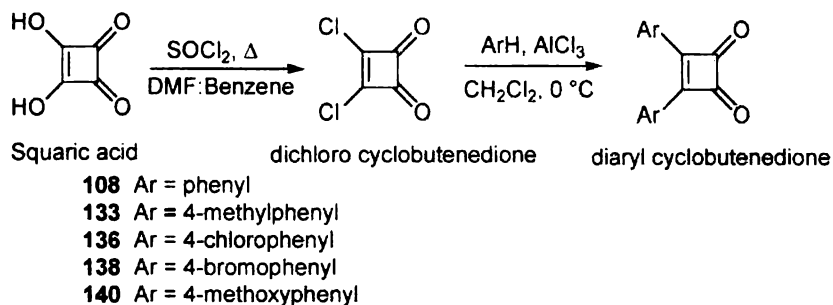

Scheme 36

It is known that dimethoxycarbene, reacts with the biscetene formed from cyclobutenedione to form a cyclopentenedione (See scheme 15).²² In a prototype experiment 3,4-ditolyl cyclobutene-1,2-dione, **133** was treated with DMAD **79** and oxadiazoline **42** in dry toluene in a sealed tube. The reaction afforded the product **134** in 53% yield (Scheme 37).

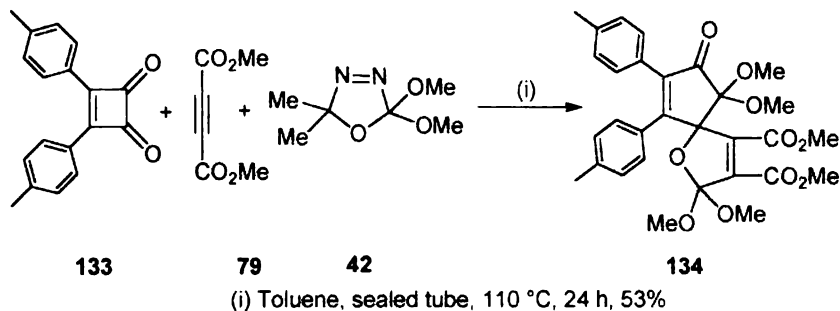

Scheme 37

The product **134** was characterized on the basis of spectroscopic analysis. The IR spectrum of **134** showed characteristic vibrations at 1730 and 1671 cm^{-1} corresponding to the ester and ketone carbonyls respectively. In the ^1H NMR spectrum the carbomethoxy protons displayed their signals at δ 3.87 and 3.73 while the methoxy protons adjacent to the ketone carbonyl were discernible at δ 3.51 and 2.68. The protons of the remaining two methoxy groups resonated at δ 3.57 and 3.55. The ^{13}C NMR spectrum of **134** revealed signals due to the spirocarbon at δ 100.2, the ester carbons at δ 162.7 and 162.3 and the ketone carbonyl at δ 195.9. The compound gave satisfactory elemental analysis also.

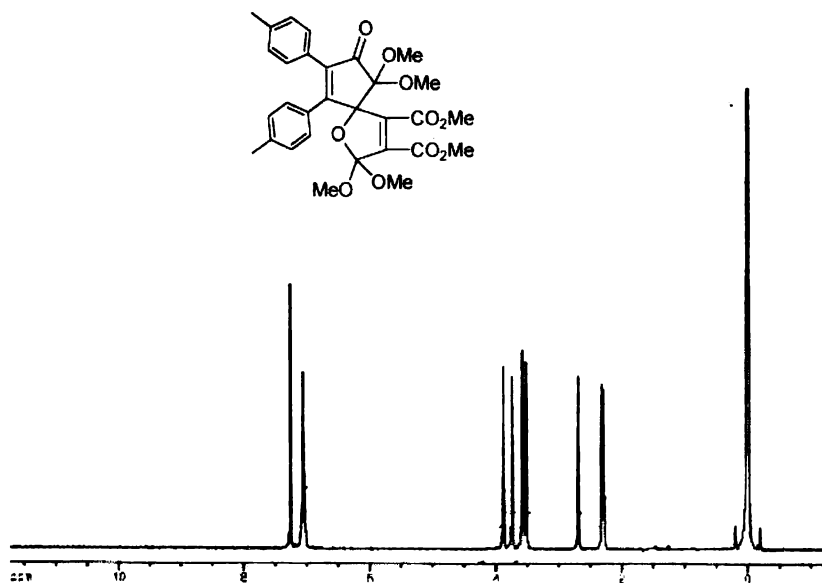

Figure 4 ^1H NMR spectrum of compound **134**

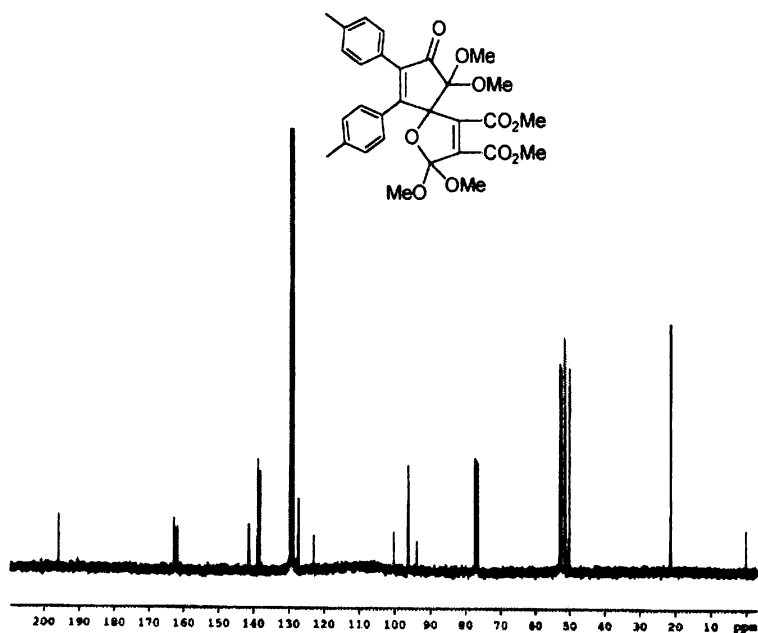

Figure 5 ^{13}C NMR spectrum of compound **134**

Final confirmation of the structure of **134** was obtained by single crystal X-ray analysis (Figure 6).

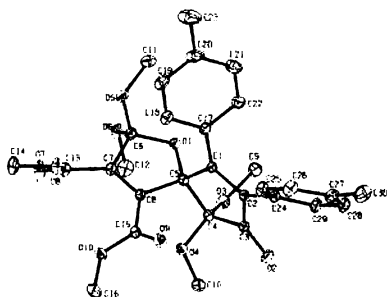
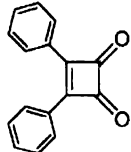
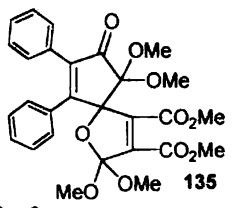
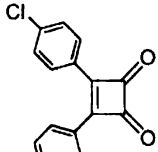
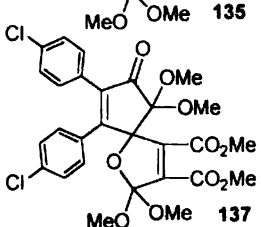
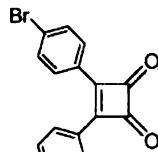
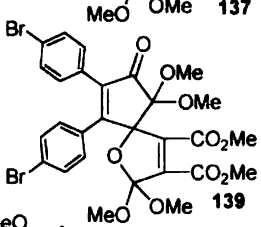
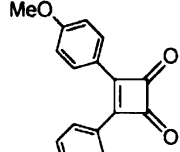
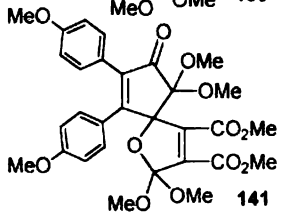

Figure 6 Single crystal X-ray structure of **134**

To test the generality of the reaction, other substituted cyclobutenediones were prepared and were subjected to the same reaction conditions. The formation of the spirodihydrofuran derivative was observed in all the cases and the results are presented in table 2.

Table 2

Entry	Substrate	Product	Yield (%)
1	 108	 135	80
2	 136	 137	50
3	 138	 139	88
4	 140	 141	42

*Reaction conditions: Oxadiazoline (2 equiv), DMAD (1.5 equiv),
Dry Toluene, Sealed tube, 24 h*

Mechanistically the reaction may be envisaged as involving two stages. The initial [4+1] cycloaddition between the carbene and the bisketene formed by the thermolysis of the cyclobutenedione can deliver the cyclopentenedione **A**. The latter then undergoes 1,3-dipolar cycloaddition with the zwitterion **B** to yield the spiroadduct. Alternatively, a [3+2] cycloaddition of the zwitterion with the C=O can also lead to the spirodihydrofuran (Scheme 38).

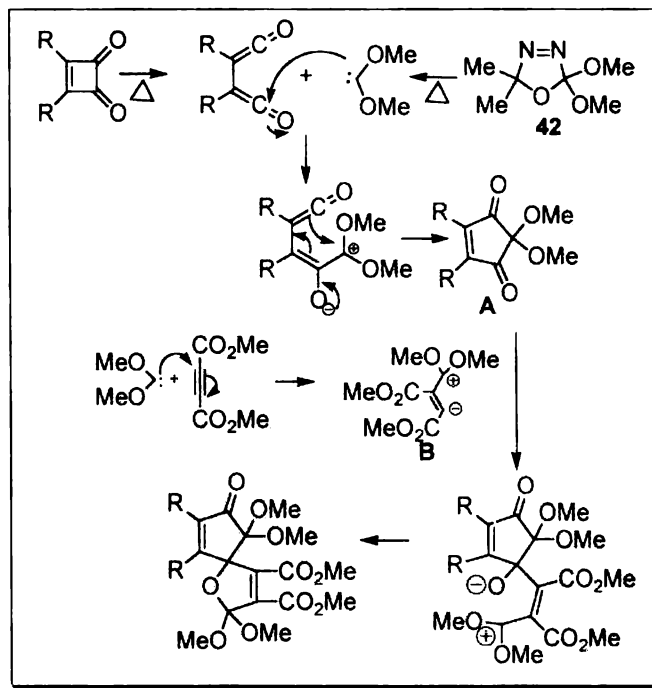

Scheme 38

Encouraged by the interesting results obtained with benzils and cyclobutene diones, we extended our investigations to *N*-substituted isatins. The latter were prepared by the reaction of isatins with alkyl bromides in presence of calcium hydride in dry DMF as the solvent. The isatins employed in the present study are shown below (Scheme 39).

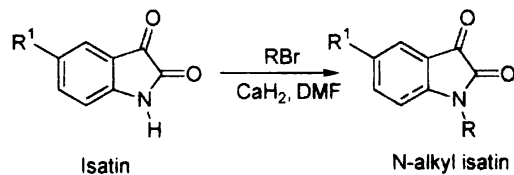

- 96** R = Methyl, R¹ = H
143 R = Ethyl, R¹ = H
145 R = Propyl, R¹ = H
147 R = Benzyl, R¹ = H
149 R = Methyl, R¹ = Br

Scheme 39

In the first experiment, N-methyl isatin **96**, DMAD **79** and oxadiazoline **42** were heated in dry toluene in a sealed tube. Processing of the reaction mixture as usual followed by column chromatography of the crude product on silica gel afforded the product **142** in 54% yield (Scheme 40).

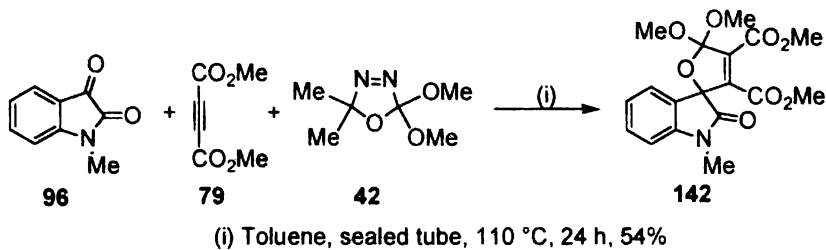

Scheme 40

The structure of the adduct **142** was ascertained by spectroscopic methods. In the ^1H NMR spectrum, signals due to the carbomethoxy and methoxy protons were discernible as sharp singlets at δ 3.91, 3.65, 3.62 and 3.43. The amide and ester carbonyl groups gave ^{13}C resonance signals at δ 171.0, 162.2 and 160.0 respectively, supporting the IR absorptions at 1678 and 1745 cm^{-1} . The resonance signal due to the spirocarbon was found at δ 86.4 in the ^{13}C NMR spectrum. The compound gave satisfactory mass analysis also.

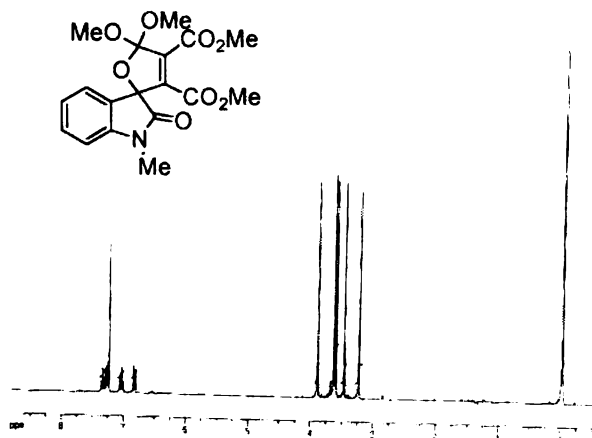

Figure 7 ^1H NMR spectrum of compound **142**

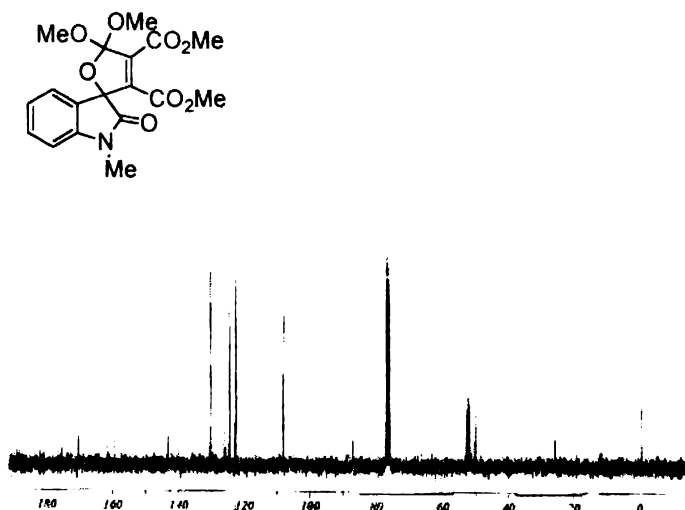
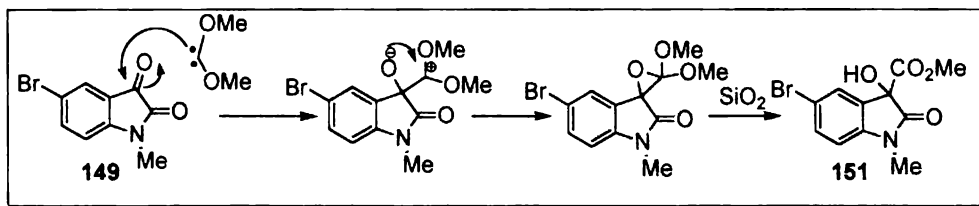

Figure 8 ^{13}C NMR spectrum of compound **142**

The reaction was found to be general with other N-substituted isatins and the results are presented in table 3. A mechanistic postulate analogous to the one suggested for the reaction of benzils could be invoked to explain the formation of the products. Formation of the hydroxy ester **151** (entry 4) can be explained along the following lines. Dimethoxycarbene first adds to the carbonyl group of the isatin to form the epoxide which during column chromatography on SiO_2 rearranges to the hydroxy ester **151** (Scheme 41). It may be mentioned that similar reaction was observed by Warkentin with fluorenone where the oxirane formed undergoes hydrolysis on silica to afford the hydroxy ester.^{17a}



Scheme 41

Table 3

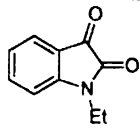
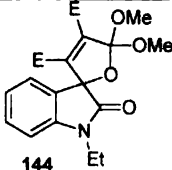
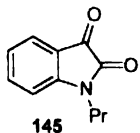
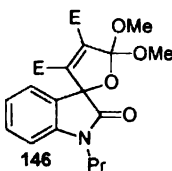
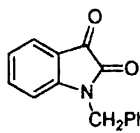
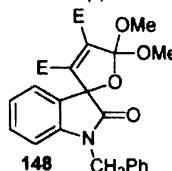
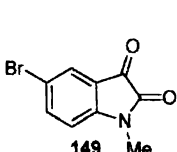
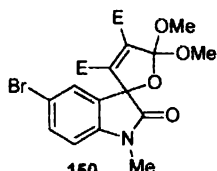
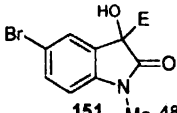
Entry	Substrate	Spirooxindoles	Yield (%)	Inserted Product
1.	 143	 144	50	(0)
2.	 145	 146	50	(0)
3.	 147	 148	48	(0)
4.	 149	 150	32	 151 48%

Reaction conditions: Oxadiazoline (2 equiv), DMAD (1.5 equiv), Dry Toluene, Sealed tube, 24 h

Subsequently, the reaction of phenanthrenequinone was investigated. Treatment of **152** with DMAD **79** and oxadiazoline **42** in a sealed tube in dry toluene for 24 h followed by column chromatography on silica gel afforded the ring enlarged compound **153** as the major product. A small amount of the spiroadduct **154** was also obtained (Scheme 42).

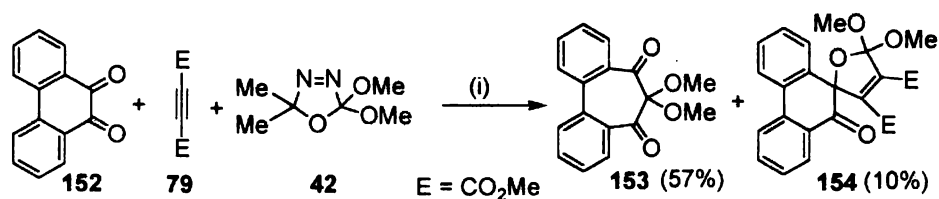

(i) Toluene, sealed tube, 110 °C, 24 h

Scheme 42

The IR spectrum of the product **153** showed characteristic carbonyl absorption peaks at 1667 and 1607 cm^{-1} . In the ^1H NMR spectrum, the methoxy protons provided sharp singlet at δ 3.50 corresponding to the six methoxy protons. The ^{13}C NMR spectrum showed resonance at δ 197.5 and 52.1 corresponding to the carbonyl and methoxy carbons respectively. The IR spectrum of product **154** showed sharp peaks at 1742 and 1694 cm^{-1} corresponding to the ester and benzoyl carbonyls respectively. In the ^1H NMR spectrum, the ester methoxy groups provided singlets at δ 3.83 and 3.49. The ^{13}C NMR spectrum of the product showed peaks at δ 160.7 and 161.2 corresponding to the ester carbonyls. The ^{13}C resonance signal at δ 86.4 corresponded to the spirocarbon.

3.6 Conclusion

In conclusion, our studies clearly show that the zwitterion formed from dimethoxycarbene and DMAD can efficiently add to cyclic and acyclic 1,2-diones. The products formed are potentially amenable to further transformations. Spiroannulated oxindole derivatives form an important structural unit of biologically active natural products such as the mycotoxin triptoquivaline.⁴⁵

3.7 Experimental Details

General information about experiments is given in Section 2 of Chapter 2. Benzil and phenanthrenequinone were purchased from Aldrich Co. and were used without further purification. All other substituted dicarbonyl compounds were prepared following known literature procedures.

General Procedure for the Synthesis of Diaryl-1,2-diones

To a 20 mL reaction vial, was added an aqueous solution of 0.13 g thiamine hydrochloride, 1.5 mL 95% ethanol, 0.25 mL 3M sodium hydroxide solution and 0.75 mL pure benzaldehyde. The mixture is heated to 60 °C and stirring was continued for 12 hours. After completion of the reaction, the mixture was poured into ice-cold water and was extracted with dichloromethane (3 x 10 mL). The combined organic extract was washed with water, brine and then dried over anhydrous sodium sulphate. After removal

of the solvent on a rotary evaporator, 2-3 mL concentrated nitric acid was added and the mixture was heated to 100 °C for 1-2 h. After completion of the reaction, the mixture was poured to ice-cold water and the product (diaryl-1,2-dione) was filtered and washed with water.

General Procedure for the Reaction of Diaryl-1,2-diones with Oxadiazoline and DMAD

Diaryl-1,2-dione (0.48 mmol), dimethyl acetylenedicarboxylate (102 mg, 0.72 mmol) and oxadiazoline (0.96 mmol) in 2 mL dry toluene was degassed and heated at 110 °C in a sealed tube for 24 h. After completion, the solvent was removed on a rotary evaporator and the residue was subjected to column chromatography on silica gel (100-200 mesh) using hexanes/ethyl acetate solvent mixtures to furnish the pure products. All dihydrofurans were eluted with 80:20 hexanes/ethyl acetate solvent mixture.

Dimethyl-2-benzoyl-5,5-dimethoxy-2-phenyl-2,5-dihydrofuran-3,4-dicarboxylate **120**:

Benzil **119** (100 mg, 0.48 mmol), dimethyl acetylenedicarboxylate **79** (102 mg, 0.72 mmol) and oxadiazoline **42** (154 mg, 0.96 mmol) were heated in dry toluene (2 mL) in a sealed tube. The reaction was processed as described in the general procedure to afford the dihydrofuran **120** (169 mg, 83%) as a white crystalline solid, mp 124-125 °C (recrystallized from CH₂Cl₂-hexanes).

IR (KBr) ν_{\max} : 3077, 2954, 2845, 1743, 1686, 1594, 1573, 1449, 1434, 1331, 1295, 1187 cm⁻¹.

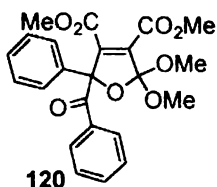

¹H NMR: δ 7.89 (d, 2H, $J = 7.5$ Hz), 7.49-7.42 (m, 3H), 7.36-7.33 (m, 5H), 3.83 (s, 3H), 3.73 (s, 3H), 3.68 (s, 3H), 3.06 (s, 3H).

¹³C NMR: δ 192.3, 167.9, 167.3, 155.9, 135.6, 133.9, 133.8,

T471

130.2, 129.3, 129.2, 128.9, 128.7, 128.4, 128.3, 111.2, 53.1, 53.0, 52.9, 52.8.

Elemental analysis Calcd for $C_{23}H_{22}O_8$: C = 64.78. H = 5.20; Found: C = 64.72, H = 5.19.

Mass spectrometric analysis (HRMS-EI) m/z calcd for $C_{23}H_{22}O_8$: 426.1315, found: 426.1319.

Dimethyl-2-(4-fluorobenzoyl)-2-(4-fluorophenyl)-5,5-dimethoxy-2,5-dihydrofuran-3,4-dicarboxylate 122:

4,4'-Difluoro benzil **121** (117 mg, 0.41 mmol), dimethyl acetylenedicarboxylate **79** (102 mg, 0.72 mmol) and oxadiazoline **42** (154 mg, 0.96 mmol) were heated in dry toluene (2 mL) in a sealed tube. The reaction was processed as described in the general procedure to afford the dihydrofuran **121** (123 mg, 65%) as a colourless viscous liquid.

IR (thin film) ν_{max} : 2954, 2928, 2851, 1743, 1686, 1619, 1491, 1434, 1357, 1341, 1207, 1146, 1108 cm^{-1} .

1H NMR: δ 7.95-7.91 (m, 2H), 7.43-7.38 (m, 2H), 7.05-7.00 (m, 4H), 3.84 (s, 3H), 3.74 (s, 3H), 3.66 (s, 3H), 3.07 (s, 3H).

^{13}C NMR: δ 193.5, 167.3, 155.4, 134.4, 134.3, 134.1, 134.0, 133.9, 129.3, 128.9, 124.5, 116.6, 116.1, 115.9, 111.0, 53.5, 53.4, 52.8, 52.6.

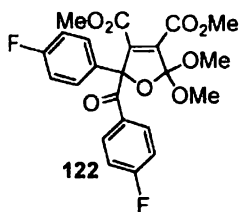

Mass spectrometric analysis (HRMS-EI): m/z calcd for $C_{23}H_{20}F_2O_8$: 462.1126; found: 462.1125.

Dimethyl-2,2-Dimethoxy-5-(4-methylbenzoyl)-5-p-tolyl-2,5-dihydrofuran-3,4-dicarboxylate 124:

4,4'-Dimethyl benzil **123** (114 mg, 0.48 mmol), dimethyl acetylenedicarboxylate **79** (102 mg, 0.72 mmol) and oxadiazoline **42** (154 mg, 0.96 mmol) in dry toluene were heated in a sealed tube. Usual processing of the reaction mixture afforded the dihydrofuran **124** (98 mg, 45%) as a colourless viscous liquid.

IR (thin film) ν_{\max} : 2959, 2922, 2856, 1743, 1686, 1604, 1444, 1264, 1192, 1125, 1042, 970 cm^{-1} .

^1H NMR: δ 7.80 (d, 2H, $J = 8.07$ Hz), 7.31-7.25 (m, 2H), 7.14-7.11 (m, 4H), 3.82 (s, 3H), 3.73 (s, 3H), 3.66 (s, 3H), 3.05 (s, 3H), 2.35 (s, 3H), 2.33 (s, 3H).

^{13}C NMR: δ 194.9, 162.1, 161.9, 144.2, 143.5, 138.5, 134.7, 133.4, 131.2, 130.3, 129.9, 128.3, 126.8, 124.1, 111.1, 53.1, 52.3, 51.7, 50.6, 40.2, 25.1, 21.3.

Mass spectrometric analysis (HRMS-EI) m/z calcd for $\text{C}_{25}\text{H}_{26}\text{O}_8$: 454.1628; found: 454.1625.

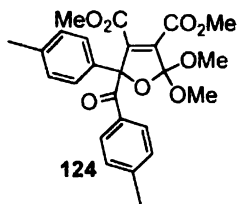

Dimethyl-2,2-dimethoxy-5-(4-trifluoromethylbenzoyl)-5-(4-trifluoromethyl)phenyl-2,5-dihydrofuran-3,4-dicarboxylate 126 and 2,2-Dimethoxy-1,3-bis(4-(trifluoromethyl)phenyl)propane-1,3-dione 127:

4,4'-Trifluoromethyl benzil **125** (171 mg, 0.48 mmol), dimethyl acetylenedicarboxylate **79** (102 mg, 0.72 mmol) and oxadiazoline **42** (154 mg, 0.96 mmol) were heated in dry toluene (2 mL) in a sealed tube. Usual processing of the reaction mixture afforded the products in increasing order of polarity. Elution with 2:98 ethyl acetate/hexanes solvent mixtures afforded the product **127** (133 mg, 66%) as a colourless viscous liquid. Further elution with 20:80 ethyl acetate/hexanes solvent mixture afforded **126** (84 mg, 31%) as a colourless viscous liquid.

IR (thin film) ν_{\max} : 2964, 2845, 1743, 1696, 1619, 1444, 1408, 1326, 1264, 1176, 1135, 1068 cm^{-1} .

^1H NMR: δ 8.02-7.97 (m, 2H), 7.68-7.56 (m, 6H), 3.85 (s, 3H), 3.76 (s, 3H), 3.69 (s, 3H), 3.08 (s, 3H).

^{13}C NMR: δ 193.2, 162.2, 161.9, 140.8, 131.0, 130.5, 129.9, 128.8, 127.2, 125.5, 125.4, 124.7, 124.6, 124.5, 111.0, 55.5, 52.7, 52.5, 51.8, 51.4, 50.8, 50.7, 29.7.

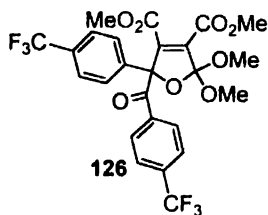

Mass spectrometric analysis (FAB): m/z calcd for $C_{25}H_{20}F_6O_8$ $[M+H]^+$: 563.1062; found: 563.1064.

IR (thin film) ν_{max} : 2964, 2918, 2851, 1831, 1676, 1614, 1578, 1413, 1326, 1249, 1161, 1130, 1068, 1011 cm^{-1} .

1H NMR: δ 7.64-7.62 (m, 8H), 3.55 (s, 6H).

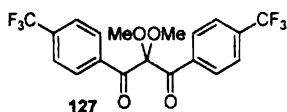

^{13}C NMR: δ 189.4, 131.2, 130.6, 128.8, 127.1, 126.5, 126.4, 126.3, 54.9, 30.5, 30.0.

Mass spectrometric analysis (HRMS-EI): m/z calcd for $C_{19}H_{14}F_6O_4$: 420.0796; found: 420.0791.

2,2-Dimethoxy-1,3-bis(3-nitrophenyl)propane-1,3-dione **129**:

3,3'-Dinitro benzil **128** (145 mg, 0.48 mmol), dimethyl acetylenedicarboxylate **79** (102 mg, 0.72 mmol) and oxadiazoline **42** (154 mg, 0.96 mmol) were heated in dry toluene (2 mL) in a sealed tube. Usual processing of the reaction mixture afforded the product **129** (172 mg, 96%) as a yellow oil.

IR (thin film) ν_{max} : 2959, 1686, 1532, 1346, 1228, 1120 cm^{-1} .

1H NMR: δ 8.39 (s, 2H), 8.20 (d, 2H, $J = 8.06$ Hz), 7.81-7.78 (m, 2H), 7.56 (uneven triplet, 2H, $J_1 = 8.06$ Hz, $J_2 = 8.54$ Hz), 3.61 (s, 6H).

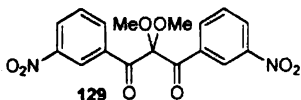

^{13}C NMR: δ 189.5, 148.9, 136.3, 135.6, 133.9, 131.7, 130.7, 130.1, 129.4, 128.7, 125.7, 124.4, 123.9, 121.3, 52.2.

Mass spectrometric analysis (HRMS-EI): m/z calcd for $C_{17}H_{14}N_2O_8$: 374.0750, found: 374.0738.

Dimethyl-2,2-dimethoxy-5-(thiophen-2-yl)-5-(thiophene-2-carbonyl)-2,5-dihydrofuran-3,4-dicarboxylate 131:

Thenil **130** (107 mg, 0.48 mmol), dimethyl acetylenedicarboxylate **79** (102 mg, 0.72 mmol) and oxadiazoline **15** (242 mg, 0.96 mmol) were heated in dry toluene (2 mL) in a sealed tube. Usual processing of the reaction mixture afforded the product **131** (149 mg, 71%) as a yellow oil.

IR (thin film) ν_{\max} : 2958, 2850, 1743, 1717, 1665, 1614, 1434, 1408, 1305, 1259, 1130 cm^{-1} .

^1H NMR: δ 7.85 (d, 2H, $J = 3.18$ Hz), 7.66 (d, 1H, $J = 4.47$ Hz), 7.34 (d, 1H, $J = 4.41$ Hz), 7.08-7.04 (m, 1H), 6.93 (uneven triplet, 1H, $J_1 = 4.68$ Hz, $J_2 = 3.87$ Hz), 3.84 (s, 3H), 3.79 (s, 3H), 3.67 (s, 3H), 3.18 (s, 3H).

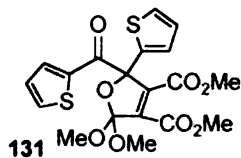

^{13}C NMR: δ 186.7, 161.6, 161.5, 142.2, 140.5, 139.2, 136.1, 135.1, 133.3, 131.2, 128.1, 127.9, 127.2, 127.0, 126.6, 115.9, 111.2, 55.6, 52.6, 52.3, 51.8.

Mass spectrometric analysis (HRMS-EI): m/z calcd for $\text{C}_{19}\text{H}_{18}\text{O}_8\text{S}_2$: 438.0443; found: 438.0449.

General Procedure for the Synthesis of Substituted Cyclobutene-1,2-diones from Squaric Acid

A solution of thionyl chloride (6.2 g, 0.052 mol) in anhydrous benzene (10 mL) was added dropwise to a suspension of commercially available squaric acid (3 g, 0.026 mol) in anhydrous benzene (10 mL) at 80 °C. After the addition of roughly half of the SOCl_2 solution, 3 drops of distilled DMF was syringed in to the reaction vessel, followed by the remaining portion of SOCl_2 solution. The reaction mixture was heated under reflux for 12 h, cooled and the excess thionyl chloride was removed by bubbling a steady stream of dry N_2 gas through the reaction mixture. The dark residue of squaryl chloride (2.8 g, 72%) obtained was used as such for the next step.

To a solution of squaryl chloride (1 g, 0.007 mol) in anhydrous dichloromethane (10 mL) was added the aromatic hydrocarbon (0.021 mol) at 0 °C. Anhydrous AlCl₃ (0.021 mol) was added in portions at 0 °C and the reaction mixture was kept at that temperature for 5 h. It was treated with cold water (10 mL), extracted with dichloromethane (3 x 10 mL) and the combined organic layer was dried over anhydrous sodium sulfate. Dichloromethane was distilled off on a rotavapor and the residue was subjected to chromatography on silica gel column using hexanes- ethyl acetate (95:5) as eluent to afford the substituted cyclobutenediones as yellow fluffy solids.

General Procedure for the Reaction of Cyclobutenediones with Oxadiazoline and DMAD

3,4-Diaryl cyclobutene 1,2-dione (0.38 mmol), dimethyl acetylenedicarboxylate (81 mg, 0.57 mmol) and oxadiazoline (122 mg, 0.76 mmol) in 2 mL dry toluene was heated in a sealed tube for 24 h. The solvent was removed on a rotary evaporator and the residue was purified by column chromatography (silica gel, 100-200 mesh; 80:20 hexanes/ethyl acetate) to give pure products.

6,7-Bis-(4-methyl-phenyl)-2,2,9,9-tetramethoxy-8-oxo-1-oxa-spiro[4.4]nona-3,6-diene-3,4-dicarboxylic acid dimethyl ester **134**:

3,4-Ditolylcyclobutene 1,2-dione **133** (100 mg, 0.38 mmol), DMAD **79** (81 mg, 0.57 mmol) and oxadiazoline **42** (122 mg, 0.76 mmol) in dry toluene (2 mL) was heated in a sealed tube for 24 h. The reaction mixture was processed as described in the general procedure to afford the spirodihydrofuran **134** (111 mg, 53%) as a colourless crystalline solid, mp 131-132 °C (recrystallized from CH₂Cl₂-hexanes).

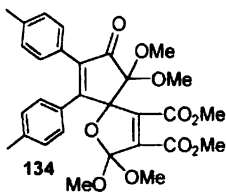

IR (thin film) ν_{\max} : 3000, 2954, 2850, 1730, 1671, 1609, 1506, 1434, 1352, 1331, 1274, 1207, 1182, 1130 cm⁻¹.

¹H NMR: δ 7.18-7.04 (m, 8H), 3.87 (s, 3H), 3.73 (s, 3H), 3.57 (s, 3H), 3.55 (s, 3H), 3.51 (s, 3H), 2.68 (s, 3H), 2.31 (s, 3H), 2.28 (s, 3H).

¹³C NMR: δ 195.9, 162.7, 162.3, 141.3, 138.8, 138.6, 138.2.

129.7, 129.5, 129.1, 128.8, 128.7, 127.2, 122.9, 100.2, 93.7, 52.9, 52.5, 51.5, 51.4, 50.2, 21.4, 21.3.

Elemental analysis Calcd for $C_{30}H_{32}O_{10}$: C = 65.21, H = 5.84;
Found: C = 65.25, H = 5.96.

2,2,9,9-Tetramethoxy-8-oxo-6,7-diphenyl-1-oxa-spiro[4.4]nona-3,6-diene-3,4-dicarboxylic acid dimethyl ester 135:

3,4-Diphenylcyclobutene 1,2-dione **108** (88 mg, 0.38 mmol), DMAD **79** (81 mg, 0.57 mmol) and oxadiazoline **42** (122 mg, 0.76 mmol) in dry toluene (2 mL) was heated in a sealed tube for 24h. Usual processing of the reaction mixture afforded the spirodihydrofuran **135** (159 mg, 80%) as a colourless oil.

IR (thin film) ν_{\max} : 2954, 2845, 1727, 1671, 1480, 1439, 1362, 1326, 1274, 1130, 1068, 975 cm^{-1} .

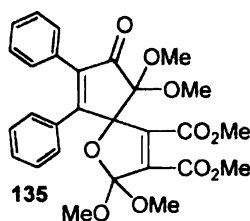

$^1\text{H NMR}$: δ 7.27-7.08 (m, 10H), 3.78 (s, 3H), 3.75 (s, 3H), 3.57 (s, 6H), 3.51 (s, 3H), 2.58 (s, 3H).

$^{13}\text{C NMR}$: δ 195.6, 163.1, 162.2, 141.5, 138.5, 132.4, 129.9, 129.5, 129.0, 128.9, 128.7, 128.6, 128.4, 128.3, 127.9, 122.9, 100.1, 52.9, 52.7, 52.5, 51.7, 51.4, 50.1.

Mass spectrometric analysis (HRMS-EI): m/z calcd for $C_{28}H_{28}O_{10}$: 524.1683; found: 524.1685.

6,7-Bis-(4-chloro-phenyl)-2,2,9,9-tetramethoxy-8-oxo-1-oxa-spiro[4.4]nona-3,6-diene-3,4-dicarboxylic acid dimethyl ester 137:

3,4-Dichlorophenyl cyclobutene 1,2-dione **136** (115 mg, 0.38 mmol), DMAD **79** (81 mg, 0.57 mmol) and oxadiazoline **42** (122 mg, 0.76 mmol) in dry toluene was heated in a sealed tube. Usual processing of the reaction mixture led to the spirodihydrofuran **137** (112 mg, 50%) as a yellow oil.

IR (thin film) ν_{\max} : 3000, 2958, 2850, 1732, 1671, 1635, 1593, 1439, 1351, 1336, 1284, 1124 cm^{-1} .

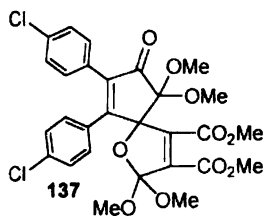

$^1\text{H NMR}$: δ 7.23-7.17 (m, 8H), 3.87 (s, 3H), 3.75 (s, 3H), 3.57 (s, 6H), 3.51 (s, 3H), 2.65 (s, 3H).

$^{13}\text{C NMR}$: δ 195.0, 162.9, 162.1, 132.7, 131.7, 131.5, 131.4, 131.0, 130.1, 129.9, 129.5, 129.2, 128.9, 128.7, 128.5, 128.4, 128.3, 123.3, 100.2, 53.3, 53.0, 52.8, 52.7, 51.9, 51.8.

Mass spectrometric analysis (HRMS-FAB): m/z calcd for $\text{C}_{28}\text{H}_{26}\text{Cl}_2\text{O}_{10}$ $[\text{M}+2+\text{H}]^+$: 595.0903; found: 595.0900.

6,7-Bis-(4-bromo-phenyl)-2,2,9,9-tetramethoxy-8-oxo-1-oxa-spiro[4.4]nona-3,6-diene-3,4-dicarboxylic acid dimethyl ester 139:

3,4-Dibromophenyl cyclobutene 1,2-dione **138** (146 mg, 0.38 mmol), DMAD **79** (81 mg, 0.57 mmol) and oxadiazoline **42** (122 mg, 0.76 mmol) in dry toluene (2 mL) was heated in a sealed tube for 24h. Usual processing of the reaction mixture afforded the spirodihydrofuran **139** (227 mg, 88%) as a yellow oil.

IR (thin film) ν_{max} : 2959, 2923, 2850, 1743, 1681, 1650, 1599, 1444, 1279, 1135, 1063 cm^{-1} .

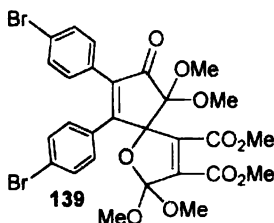

$^1\text{H NMR}$: δ 7.23-7.17 (m, 8H), 3.87 (s, 3H), 3.76 (s, 3H), 3.57 (s, 6H), 3.51 (s, 3H), 2.66 (s, 3H).

$^{13}\text{C NMR}$: δ 195.0, 162.9, 162.2, 132.7, 131.6, 131.4, 131.5, 131.1, 130.2, 129.9, 129.8, 129.4, 129.2, 128.9, 128.8, 128.5, 128.5, 128.3, 123.2, 100.2, 53.2, 53.1, 52.9, 52.8, 51.9, 51.8.

Mass spectrometric analysis (HRMS-FAB): m/z calcd for $\text{C}_{28}\text{H}_{26}\text{Br}_2\text{O}_{10}$ $[\text{M}+2+\text{H}]^+$: 682.9893; found: 682.9899.

6,7-Bis-(4-methoxy-phenyl)-2,2,9,9-tetramethoxy-8-oxo-1-oxa-spiro[4.4]nona-3,6-diene-3,4-dicarboxylic acid dimethyl ester 141:

3,4-Dimethoxyphenyl cyclobutene 1,2-dione **140** (112 mg, 0.38 mmol), DMAD **79** (81 mg, 0.57 mmol) and oxadiazoline **42** (122 mg, 0.76 mmol) in dry toluene (2 mL) was heated in a sealed tube for 24h. Usual processing of the reaction mixture led to the spirodihydrofuran **141** (93 mg, 42%) as a yellow oil.

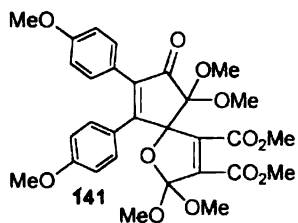

IR (thin film) ν_{\max} : 2954, 2928, 2850, 1743, 1681, 1604, 1501, 1434, 1326, 1248, 1181, 1032 cm^{-1} .

^1H NMR: δ 7.26-7.23 (m, 2H), 7.15-7.13 (m, 2H), 6.90 (d, 2H, $J = 8.3$ Hz), 6.75 (d, 2H, $J = 8.5$ Hz), 3.93-3.87 (m, 6H), 3.83-3.79 (m, 4H), 3.77-3.72 (m, 6H), 3.66-3.60 (m, 5H), 3.00 (s, 3H).

^{13}C NMR: δ 195.1, 166.7, 165.3, 160.4, 160.1, 152.9, 145.3, 130.9, 130.8, 130.7, 129.5, 123.6, 120.8, 115.2, 114.4, 113.9, 113.8, 113.7, 110.3, 100.2, 55.2, 55.0, 53.2, 53.0, 52.8, 51.9, 51.7.

Mass spectrometric analysis (HRMS-FAB): m/z calcd for $\text{C}_{30}\text{H}_{32}\text{O}_{12}$ $[\text{M}+\text{H}]^+$: 585.1894; found: 585.1890.

General Procedure for the Synthesis of N-alkyl Substituted Isatins

To a solution of isatin (500 mg, 3.39 mmol) in dry DMF (10 mL) was added powdered calcium hydride (472 mg, 11.21 mmol) and the mixture was stirred with gentle warming (40 °C-50 °C) for half an hour. The alkylating agent (16.99 mmol) was added to the reaction mixture at room temperature and was stirred for 4-5 h. The reaction mixture was then poured slowly to a solution of brine (0.2 N HCl was added dropwise to NaCl solution). Extraction was done using ethyl acetate several times. Evaporation of the solvent left a residue which was then subjected to chromatography on a silica gel column using 80:20 hexanes-ethyl acetate solvent mixtures to afford the N-alkyl derivative of isatin.

General Procedure for the Reaction of N-Substituted Isatins with Oxadiazoline and DMAD

A mixture of N-alkyl isatin (0.31 mmol), dimethyl acetylenedicarboxylate (132 mg, 0.93 mmol) and oxadiazoline (198 mg, 1.24 mmol) was refluxed in 2 mL dry toluene in a sealed tube for 24 h. The solvent was removed on a rotary evaporator and the residue was purified by column chromatography (silica gel, 100-200 mesh;

neutralized by adding triethyl amine) using 70:30 hexanes/ethyl acetate to give the pure product.

Spiro[1'-methylindole-1(2H)-4-dimethoxy-2,3-bis(methoxycarbonyl)furan]-2-one
142:

A mixture of N-methyl isatin **96** (50 mg, 0.31 mmol), DMAD **79** (132 mg, 0.93 mmol) and oxadiazoline **42** (198 mg, 1.24 mmol) was refluxed in dry toluene (2 mL) in a sealed tube for 24h. Processing of reaction mixture as specified in the general procedure afforded product **142** (63 mg, 54%) as a yellow oil.

IR (thin film) ν_{\max} : 2945, 2850, 1745, 1678, 1602, 1457, 1270, 1162, 1055 cm^{-1} .

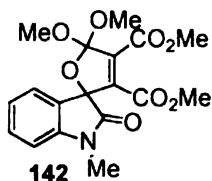

^1H NMR: δ 7.37-6.83 (m, 4H), 3.91 (s, 3H), 3.65 (s, 3H), 3.62 (s, 3H), 3.43 (s, 3H), 3.25 (s, 3H).

^{13}C NMR: δ 171.0, 162.2, 160.0, 143.6, 140.5, 130.8, 126.5, 125.0, 124.9, 123.1, 108.6, 86.4, 53.2, 52.8, 52.6, 52.5, 52.4, 51.9, 50.6, 50.5, 50.3, 26.5.

Mass spectrometric analysis (HRMS-EI): m/z calcd for $\text{C}_{18}\text{H}_{19}\text{NO}_8$: 377.1111; found: 377.1115.

Spiro[1'-ethylindole-1(2H)-4-dimethoxy-2,3-bis(methoxycarbonyl)furan]-2-one
144:

A mixture of N-ethyl isatin **143** (55 mg, 0.31 mmol), DMAD **79** (132 mg, 0.93 mmol) and oxadiazoline **42** (198 mg, 1.24 mmol) was refluxed in dry toluene (2 mL) in a sealed tube for 24h. Usual processing of the reaction mixture afforded the product **144** (61 mg, 50%) as a yellow oil.

IR (thin film) ν_{\max} : 2948, 2847, 1730, 1681, 1613, 1485, 1465, 1249, 1150, 1051 cm^{-1} .

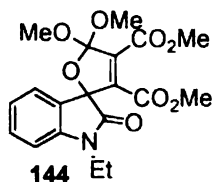

^1H NMR: δ 7.33-6.84 (m, 4H), 3.91 (s, 3H), 3.62 (s, 3H), 3.58 (s, 3H), 3.49 (s, 3H), 3.14 (m, 2H), 1.31 (t, 3H, $J = 7.19$ Hz).

^{13}C NMR: δ 171.2, 162.4, 160.1, 143.7, 140.6, 136.3, 130.9, 126.6,

125.1, 125.0, 123.3, 108.8, 85.4, 53.4, 53.1, 52.7, 50.8, 35.2, 12.5.

Mass spectrometric analysis (HRMS-EI): m/z calcd for $C_{19}H_{21}NO_8$: 391.1267; found: 391.1269.

Spiro[1'-propylindole-1(2H)-4-dimethoxy-2,3-bis(methoxycarbonyl)furan]-2-one 146:

A mixture of N-propyl isatin **45** (60 mg, 0.31 mmol), DMAD **79** (132 mg, 0.93 mmol) and oxadiazoline **42** (198 mg, 1.24 mmol) was refluxed in dry toluene (2 mL) in a sealed tube for 24 h. Usual processing of the reaction mixture afforded the product **146** (63 mg, 50%) as yellow oil.

IR (thin film) ν_{\max} : 2955, 2890, 2850, 1730, 1681, 1613, 1472, 1450, 1310, 1250, 1190, 1050 cm^{-1} .

^1H NMR: δ 7.3-6.78 (m, 4H), 3.85 (s, 3H), 3.70 (m, 2H), 3.70 (s, 3H), 3.55 (s, 3H), 3.43 (s, 3H), 1.66 (m, 2H), 0.99 (t, 3H, $J = 7.37$ Hz).

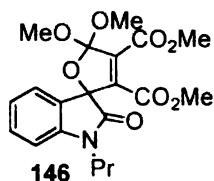

^{13}C NMR: δ 171.9, 162.9, 160.7, 135.7, 130.3, 128.9, 126.9, 123.8, 120.1, 109.6, 86.4, 55.9, 54.6, 51.9, 51.7, 35.1, 15.6, 12.3.

Mass spectrometric analysis (HRMS-EI): m/z calcd for $C_{20}H_{23}NO_8$: 405.1424; found: 405.1420.

Spiro[1'-benzylindole-1(2H)-4-dimethoxy-2,3-bis(methoxycarbonyl)furan]-2-one 148:

A mixture of N-benzyl isatin **147** (74 mg, 0.31 mmol), DMAD **79** (132 mg, 0.93 mmol) and oxadiazoline **42** (198 mg, 1.24 mmol) was refluxed in dry toluene (2 mL) in a sealed tube for 24 h. Usual processing of the reaction mixture afforded the product **148** (67 mg, 48%) as yellow oil.

IR (thin film) ν_{\max} : 2955, 2847, 1742, 1679, 1620, 1495, 1445, 1256, 1182, 1128, 980 cm^{-1} .

^1H NMR: δ 7.33-7.16 (m, 9H), 5.12 (d, 1H, $J = 9$ Hz), 4.66 (d, 1H,

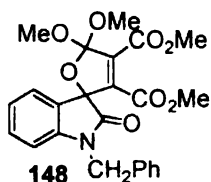

$J = 15$ Hz), 3.84 (s, 3H), 3.60 (s, 3H), 3.44, (s, 3H), 3.43 (s, 3H).

$^{13}\text{C NMR}$: δ 171.7, 162.2, 160.1, 143.7, 140.8, 136.2, 135.5, 130.8, 128.8, 127.3, 127.6, 126.4, 125.0, 124.7, 123.3, 109.6, 86.4, 53.2, 52.8, 52.5, 51.8, 50.7.

Mass spectrometric analysis (HRMS-EI): m/z calcd for $\text{C}_{24}\text{H}_{23}\text{NO}_8$: 453.1424, found: 453.1428.

Spiro[1'-methyl-5-bromo-indole-1(2H)-4-dimethoxy-2,3-bis(methoxycarbonyl)furan]-2-one **150 and 5-bromo-1-methyl-3-carbomethoxy-3-hydroxy-indol-2-one **151**:**

A mixture of 5-bromo N-methyl isatin **149** (74 mg, 0.31 mmol), DMAD **79** (132 mg, 0.93 mmol) and oxadiazoline **42** (198 mg, 1.24 mmol) was refluxed in dry toluene (2 mL) in sealed tube for 24 h. Usual processing of the reaction mixture led to isolation of two products in increasing polarities. Elution with 85:15 hexane/ EtOAc gave the product **151** (44 mg, 48%) as colourless oil. Further elution with 70:30 hexane/ethylacetate yielded the product **150** (45 mg, 32%) as a yellow oil.

IR (thin film) ν_{max} : 2949, 2846, 1744, 1678, 1609, 1485, 1444, 1227, 1279, 980 cm^{-1} .

$^1\text{H NMR}$: δ 7.25-7.22 (m, 2H), 6.48-6.40 (m, 1H), 3.81 (s, 3H), 3.69 (s, 3H), 3.62 (s, 3H), 3.40 (s, 3H), 3.25 (s, 3H).

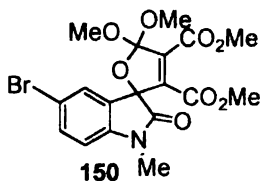

$^{13}\text{C NMR}$: δ 171.1, 162.1, 160.0, 142.6, 141.5, 130.7, 126.6, 125.0, 124.9, 52.7, 52.5, 51.8, 50.7, 50.6, 26.5.

Mass spectrometric analysis (HRMS-EI): m/z calcd for $\text{C}_{18}\text{H}_{18}\text{BrNO}_8$: 455.0216; found: 455.0218.

IR (thin film) ν_{max} : 3451, 2954, 2650, 1734, 1618, 1470, 1347, 1260, 1152, 1113, 1105, 980 cm^{-1} .

$^1\text{H NMR}$: δ 7.85-7.82 (m, 2H), 7.41-7.38 (m, 1H), 6.49 (s, 1H),

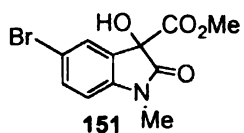

3.68 (s, 3H), 2.91 (s, 3H).

^{13}C NMR: δ 171.8, 159.2, 133.8, 131.4, 128.2, 121.6, 116.4, 107.6, 85.7, 52.6, 26.2.

Mass spectrometric analysis (HRMS-EI): m/z calcd for $\text{C}_{11}\text{H}_{10}\text{BrNO}_4$: 298.9793; found: 298.9740.

6,6-Dimethoxy-dibenzo[*a,c*]cycloheptene-5,7-dione 153 and Spiro[phenanthrene-1(2H)-4-dimethoxy-2,3-bis(methoxycarbonyl)furan]-2-one 154 :

A mixture of **152** (100 mg, 0.48 mmol), DMAD **79** (102 mg, 0.72 mmol) and oxadiazoline **42** (154 mg, 0.96 mmol) was refluxed in dry toluene (2 mL) in sealed tube for 24 h. The solvent was removed on a rotary evaporator and the residue was purified by column chromatography (silica gel 100-200 mesh, neutralized by adding triethyl amine) using hexanes-ethyl acetate solvent mixture to afford the products in increasing order of polarities. Elution with hexane gave the product **153** (77 mg, 57%) as an amorphous solid. Further elution with 90:10 hexanes/ethyl acetate afforded the product **154** as a colourless liquid (21 mg, 10%).

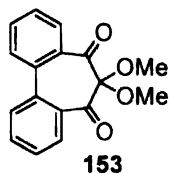

IR (thin film) ν_{max} : 2921, 2850, 1667, 1607, 1482, 1380, 1250, 1130, 1100, 1031, 980 cm^{-1} .

^1H NMR: δ 8.57 (d, 2H, $J = 8.26$ Hz), 7.92-7.89 (m, 2H), 7.57-7.4 (m, 4H), 3.50 (s, 6H).

^{13}C NMR: δ 197.5, 136.4, 132.9, 127.2, 126.7, 124.2, 123.3, 54.7, 52.1.

Mass spectrometric analysis (HRMS-EI): m/z calcd for $\text{C}_{17}\text{H}_{14}\text{O}_4$: 282.0892, found: 282.0899.

IR (thin film) ν_{max} : 2955, 2850, 1742, 1694, 1600, 1380, 1120, 1010, 985 cm^{-1} .

^1H NMR: δ 7.99-7.88 (m, 3H), 7.64-7.53 (m, 2H), 7.40-7.27 (m,

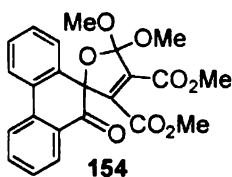

3H), 3.83 (s, 3H), 3.49 (s, 3H), 3.40 (s, 3H), 3.35 (s, 3H).

^{13}C NMR: δ 191.2, 161.2, 160.7, 147.6, 134.0, 132.9, 129.5, 128.5, 127.1, 124.1, 113.5, 110.8, 108.1, 86.4, 53.8, 52.9, 52.5, 51.9, 50.2.

Mass spectrometric analysis (HRMS-EI): m/z calcd for $\text{C}_{23}\text{H}_{20}\text{O}_8$: 424.1158, found: 424.1179.

3.8 References

1. a) Herrmann, W. A. *Angew. Chem., Int. Ed. Engl.* **2002**, *41*, 1290. b) Herrmann, W. A.; Köcher, C. *Angew. Chem., Int. Ed. Engl.* **1997**, *36*, 2162.
2. a) Rondan, N. G.; Houk, K. N.; Moss, R. A. *J. Am. Chem. Soc.* **1980**, *102*, 1770. b) Moss, R. A.; Wlostowski, M.; Shen, S.; Krogh-Jespersen, K.; Matro, A. *J. Am. Chem. Soc.* **1988**, *110*, 4443.
3. a) Moss, R. A. *Acc. Chem. Res.* **1989**, *22*, 15. b) Moss, R. A. *Acc. Chem. Res.* **1980**, *13*, 58.
4. Hoffmann, R. W. *Angew. Chem., Int. Ed. Engl.* **1971**, *10*, 529.
5. a) Moss, R. A.; Wlostowki, M.; Terpinski, J.; Kmeick-Lawrynowicz, G.; Krogh-Jespersen, K. *J. Am. Chem. Soc.* **1987**, *109*, 3811. b) Moss, R. A. *Acc. Chem. Res.* **2006**, 267.
6. El-Saidi, M.; Kassam, K.; Pole, D. L.; Tadey, J.; Warkentin, J. *J. Am. Chem. Soc.* **1992**, *114*, 875.
7. Warkentin, J. *J. Chem. Soc., Perkin Trans. 1* **2000**, 2161 and references cited therein.
8. Warkentin, J. *Synthesis* **1970**, 279.
9. Yang, R. -Y.; Dai, L. -X. *J. Org. Chem.* **1993**, *58*, 338.
10. Chiba, T.; Okimoto, M. *J. Org. Chem.* **1992**, *57*, 1375.
11. Kassam, Pole, D. L.; El-Saidi, M.; Warkentin, J. *J. Am. Chem. Soc.* **1994**, *116*, 1161.
12. Zhou, H.; Mloston, G.; Warkentin, J. *Org. Lett.* **2005**, *7*, 487.

13. Hoffmann, R. W.; Lilienblum, W.; Dittrich, B. *Chem. Ber.* **1974**, *107*, 3395.
14. Hoffmann, R. W.; Steinbach, K.; Dittrich, B. *Chem. Ber.* **1973**, *106*, 2174.
15. Hoffmann, R. W.; Steinbach, K.; Lilienblum, W. *Chem. Ber.* **1976**, *109*, 1759.
16. Pole, D. L.; Warkentin, J. *Liebigs Ann.* **1995**, 1907.
17. a) Pole, D. L.; Warkentin, J. *J. Org. Chem.* **1997**, *62*, 4065. b) David, M.; Mloston, G.; Warkentin, J. *Org. Lett.* **2001**, *3*, 2455.
18. a) Couture, P.; Pole, D. L.; Warkentin, J. *J. Chem. Soc., Perkin Trans. 2* **1997**, 1565. b) Moss, R. A.; Wlostowski, M.; Shen, S.; Krogh-Jespersen, K.; Matro, A. *J. Am. Chem. Soc.* **1988**, *110*, 4443.
19. Dunn, J. A.; Pezacki, J. P.; McGlinchey, M. J.; Warkentin, J. *J. Org. Chem.* **1999**, *64*, 4344.
20. Lilienblum, W.; Hoffmann, R. W. *Chem. Ber.* **1977**, *110*, 3405.
21. Gerninghaus, C.; Kümmell, A.; Seitz, G. *Chem. Ber.* **1993**, *126*, 733.
22. Colomvakos, J. D.; Egle, I.; Ma, J.; Pole, D. L.; Tidwell, T. T.; Warkentin, J. *J. Org. Chem.* **1996**, *61*, 9522.
23. Rigby, J. H.; Cavezza, A.; Ahmed, G. *J. Am. Chem. Soc.* **1996**, *118*, 12848.
24. Rigby, J. H.; Wang, Z. *Org. Lett.* **2003**, *5*, 263.
25. Spino, C.; Rezael, H.; Dupont-Gaudet, K.; Bèlanger, F. *J. Am. Chem. Soc.* **2004**, *126*, 9926.
26. Kassam, K.; Warkentin, J. *J. Org. Chem.* **1994**, *59*, 5071.
27. Lu, X.; Warkentin, J. *Tetrahedron Lett.* **1999**, *40*, 1483.
28. Venneri, P. C.; Warkentin, J. *J. Am. Chem. Soc.* **1998**, *120*, 11182.
29. Plazuk, D.; Warkentin, J.; Werstiuk, N. H. *Tetrahedron* **2005**, *61*, 5788.
30. a) Nair, V.; Bindu, S.; Balagopal, L. *Tetrahedron Lett.* **2001**, *42*, 2043. b) Nair, V.; Beneesh, P. B.; Sreekumar, V.; Bindu, S.; Menon, R. S.; Ani Deepthi *Tetrahedron Lett.* **2005**, *48*, 201.
31. Nair, V.; Bindu, S.; Sreekumar, V.; Chiaroni, A. *Org. Lett.* **2002**, *4*, 2821.

32. For reviews see, a) Sumpter, W. C. *Chem. Rev.* **1954**, *34*, 407. b) Popp, F. D. *Adv. Heterocycl. Chem.* **1975**, *18*, 1. c) da Silva, J. F. M.; Garden, S. J.; Pinto, A. C. *J. Braz. Chem. Soc.* **2001**, *12*, 273. d) Shvekhgeimer, M. G. A. *Chem. Heterocycl. Compd. (Engl. Transl.)* **1996**, *32*, 249.
33. a) Bauer, D. J.; Sadler, P. W. *Brit. J. Pharmacol.* **1960**, *15*, 101. b) Lackey, K.; Besterman, J. M.; Fletcher, W.; Leitner, P.; Morton, B.; Sternbach, D. D. *J. Med. Chem.* **1995**, *38*, 906.
34. a) Sumpter, W. C.; Miller, F. M. in *Heterocyclic Compounds with Indole and Carbazole Systems*; Interscience: New York, 1954. b) Garden, S. J.; Torres, J. C.; Silva, L. E.; Pinto, A. C. *Synth. Commun.* **1998**, *28*, 1679.
35. Katz, A. H.; Demerson, C. A.; Humber, L. G. *US 4, 670, 462*, **1987**. (CA 107: P96704j).
36. a) Nair, V.; Sheela, K. C.; Sethumadhavan, D.; Bindu, S.; Rath, N. P.; Eigendorf, G. K. *Synlett* **2001**, 272. b) Nair, V.; Mathai, S.; Mathew, S. C.; Rath, N. P. *Tetrahedron* **2005**, *61*, 2849. c) Nair, V.; Mathai, S.; Augustine, A.; Viji, S.; Radhakrishnan, K.V. *Synthesis* **2004**, 2617. d) Nair, V.; Rajesh, C.; Dhanya, R.; Rath, N. P. *Tetrahedron Lett.* **2002**, *43*, 5349.
37. a) Coulter, T.; Grigg, R.; Malone, J. F.; Sridharan, V. *Tetrahedron Lett.* **1991**, *32*, 5417. b) Fokas, D.; Ryan, W. J.; Casebier, D. S.; Coffen, D. L. *Tetrahedron Lett.* **1998**, *39*, 2235. c) Nair, V.; Sheela, K. C.; Rath, N. P. *Chem. Lett.* **2000**, 980.
38. a) Nair, V.; Biju, A. T.; Vinod, A. U.; Suresh, E. *Org. Lett.* **2005**, *7*, 5139. b) Nair, V.; Sreekanth, A. R.; Biju, A. T.; Rath, N. P. *Tetrahedron Lett.* **2003**, *44*, 729.
39. a) Liebeskind, L. S.; Mitchell, D. M.; Foster, B. S. *J. Am. Chem. Soc.* **1987**, *109*, 7908. b) Liebeskind, L. S.; Chidambaram, R.; Mitchell, D. M.; Foster, B. S. *Pure and Applied Chemistry* **1988**, *60*, 2734. c) Petasis, N. A. *Synlett* **1996**, 155. d) Liebeskind, L. S.; Iyer, S.; Jewell, C. F. Jr. *J. Org. Chem.* **1986**, *51*, 3065. e) Liebeskind, L. S. *Tetrahedron* **1989**, *45*, 3053.

40. Ried, W.; Knorr, H.; Kuhn, W.; Weißert, U. *Chem. Ber.* **1975**, *108*, 1413.
41. a) Argyropoulos, N. E.; Alexandrou, N. E.; Nicolaides, D. N. *Tetrahedron Lett.* **1976**, *17*, 83. b) Grundmann, C.; Grunanger, P. *The Nitrile Oxides*; Springer-Verlag: Berlin, 1971, p 120.
42. Nair, V.; Abhilash, N.; Beneesh, P. B.; Suresh, E. *Org. Lett.* **2005**, *7*, 4625.
43. Williamson, K. L. *Macroscale and Microscale Organic Experiments*, 2nd Ed. 1994.
44. De Selms, R. C.; Fox, C. J.; Riordan, R. C. *Tetrahedron Lett.* **1970**, *11*, 781.
45. a) Büchi, G.; DeShong, P. R.; Katsumura, S.; Sugimura, Y. *J. Am. Chem. Soc.* **1979**, *101*, 5084. b) Ohnuma, T.; Kimura, Y.; Ban, Y. *Tetrahedron Lett.* **1981**, *22*, 4969. c) Nakagawa, M.; Taniguchi, M.; Sodeoka, M.; Ito, M.; Yamaguchi, K.; Hino, T. *J. Am. Chem. Soc.* **1983**, *105*, 3709.

The Reaction of Isocyanide-DMAD Zwitterion with Vicinal Tricarbonyl Systems - Synthesis of Highly Substituted Furan Derivatives

4.1 Introduction

Isocyanides¹ belong to a rare class of organic compounds with a formally divalent carbon. For long time, isocyanides were considered as unnatural molecules with a vile odour, but the last century saw a number of natural products containing isocyanide functionality being isolated.² Isocyanide chemistry underwent a facelift with the discovery of the monumental Ugi and Passerini reactions. The present chapter deals with a new multicomponent reaction (MCR) of vicinal tricarbonyl compounds with isocyanides and dimethyl acetylenedicarboxylate (DMAD). Before going to the results, a brief overview of isocyanide chemistry is presented. This is followed by a brief introduction to tricarbonyl compounds.

4.2 Isocyanides

Isocyanides are isoelectronic with carbon monoxide and is shown to be of linear geometry by electron diffraction and microwave studies.³

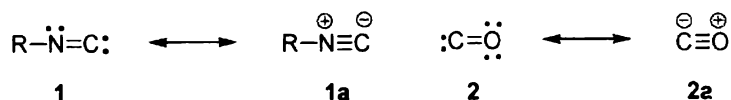
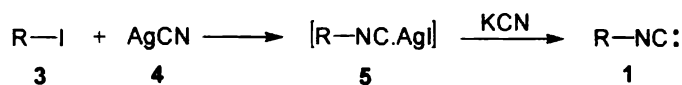

Figure 1

The presence of both non-bonding electrons and electron-deficient π -orbitals imparts a dual character to the isocyanide carbon, which is clear from its chemical properties. The reason why isocyanides were not used for a long time was neither their suspected toxicity nor their vile odour, but rather the lack of accessibility to pure isocyanides. There are various methods available for the synthesis of isocyanides and these are given below.

4.2.1 Synthesis of isocyanides

Gautier in 1867 identified isocyanides in the reaction of alkyl iodides with silver cyanide. The isocyanide-silver iodide complex formed, on treatment with potassium cyanide afforded the isocyanide (Scheme 1).⁴



Scheme 1

Another method for the synthesis of isocyanides is the Hofmann carbylamine reaction. This involves the reaction of primary amines with chloroform in basic conditions followed by elimination of hydrogen chloride as shown below. The reaction occurs by an initial insertion of the dichlorocarbene generated from chloroform in basic conditions into the N-H bond followed by α -elimination (Scheme 2).⁵

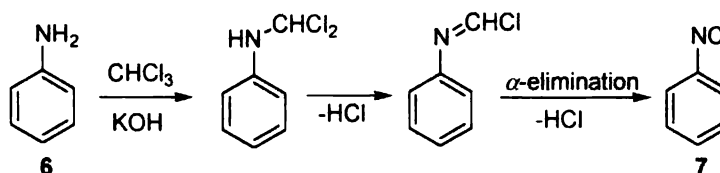

Scheme 2

The most convenient method for the synthesis of isocyanides was developed by Ugi and it is based on the dehydration of N-substituted formamides with phosgene in presence of triethylamine.⁶

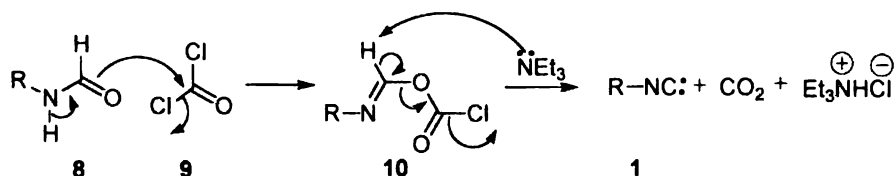

Scheme 3

Later on, several other dehydrating agents were used to replace the toxic phosgene in the synthesis of isocyanides. These include thionyl chloride, *p*-toluene sulfonyl chloride, phosphorus tribromide, triphenylphosphine dibromide and

chlorodimethylformiminium chloride in combination with bases like trialkylamine, pyridine, quinoline and potassium carbonate.⁷

4.2.2 Chemistry of Isocyanides

The chemistry of isocyanides is centered mainly on its three basic properties of α -acidity, α -addition and propensity to form radicals as shown below (Scheme 4).

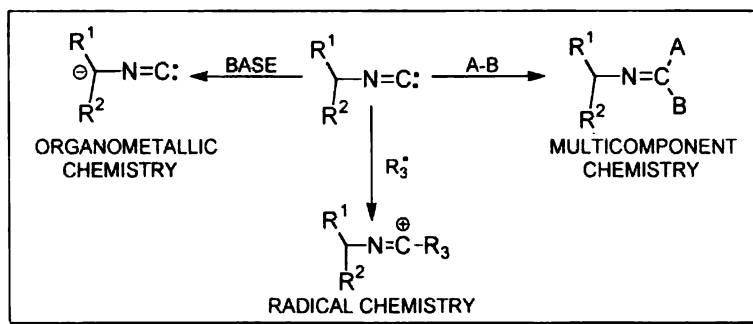

Scheme 4

4.2.2.1 α -Metallation

Isocyanides can undergo two types of reactions with organometallic reagents depending on their structure. If the isocyanides possess α -hydrogen atom, α -metallated isocyanides **13** are produced whereas if the isocyanides lack α -hydrogen, metalloaldimines of the type **12** are obtained as shown below (Scheme 5).

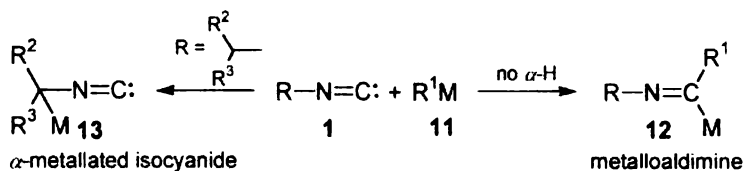

Scheme 5

Schöllkopf has shown that α -metallated isocyanides can be used for a variety of purposes like chain extension of amines and amino acids, heterocyclic synthesis and carbonyl olefinations.⁸ A general scheme for the addition of α -metallated isocyanides to polar double bonds such as carbonyls and imines is shown below (Scheme 6). All other relevant informations in this area are covered in the review by Hoppe.⁹

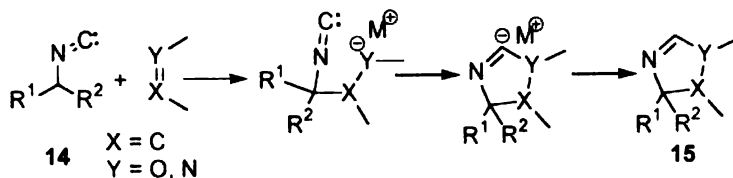

Scheme 6

The presence of electron-withdrawing substituent at the α -carbon of isocyanide, as in tosylmethyl isocyanide (TosMIC) **16**, has a profound effect on the reactivity pattern. The synthetic utility of TosMIC has been extensively investigated by Van Leusen's group and hence TosMIC is known as Van Leusen reagent.¹⁰ A variety of bases under mild conditions can be used to remove the α -hydrogen of TosMIC. Oxazolines **18** are produced by the reaction of **16** with aldehydes in protic solvents at 20 °C,¹¹ whereas under reflux conditions oxazole **20** is formed by the elimination of *p*-toluene sulphonic acid (Scheme 7).¹²

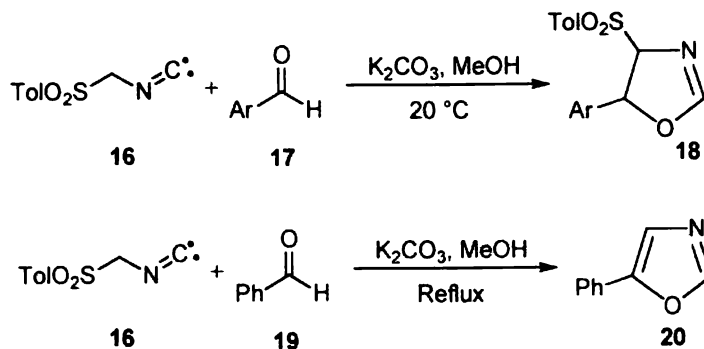

Scheme 7

Similar reactions with imines led to the formation of imidazoles whereas thiazoles were formed with dithioesters or carbon disulphide.

4.2.2.2 Radical reactions

Radical species can add to isocyanides to form imidoyl radicals which are common intermediates in all isocyanide based radical reactions as shown below (Scheme 8).

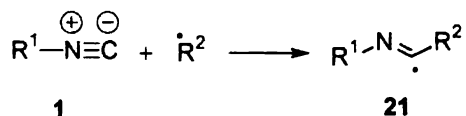

Scheme 8

The imidoyl radical **21** thus formed can undergo β -scission or can add to various carbon-carbon or carbon-heteroatom double bonds or can add to other radical species to form a variety of products. A generalized representation of the fate of the imidoyl radical is given below (Scheme 9).

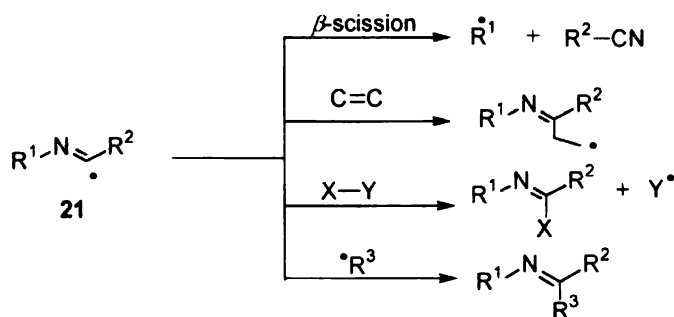

Scheme 9

Fukuyama applied the intramolecular capture of the imidoyl radical by styrenic double bonds in an efficient route to 2,3-disubstituted indoles **23** starting from 2-alkenylphenyl isocyanide **22** (Scheme 10).¹³

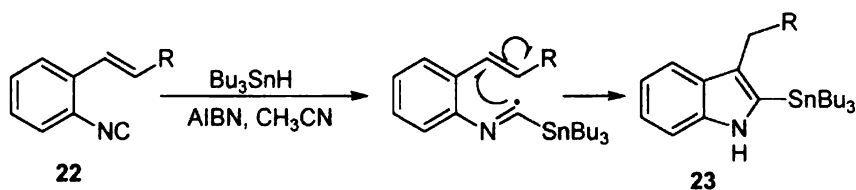

Scheme 10

An elegant use of radical initiated cyclization reaction of isocyanides is illustrated in the synthesis of Camptothecin by Curran. The reaction of bromopyridine **24**, phenyl isocyanide and hexamethylditin afforded the intermediate **25** after two radical cyclizations and an oxidative rearomatization (Scheme 11).¹⁴

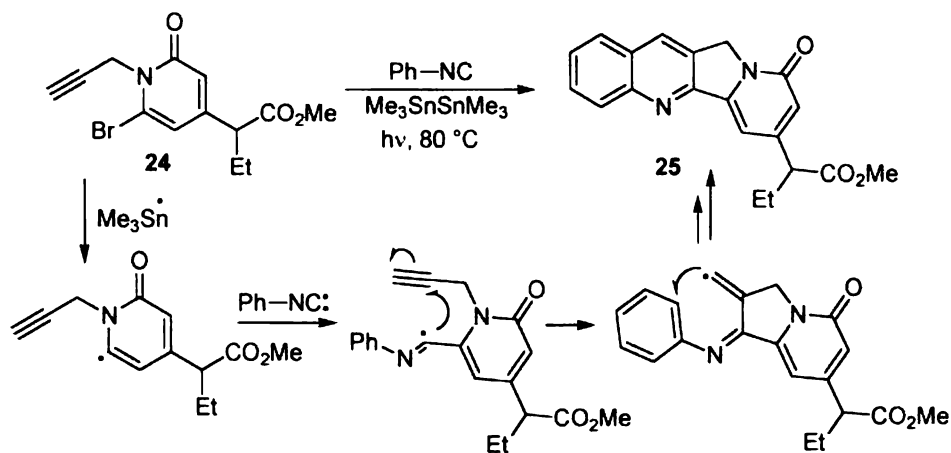

Scheme 11

4.2.2.3 Multicomponent reactions

Isocyanides are very useful in multicomponent reactions due to the diversity of bond forming processes available for the molecule. A detailed account of isocyanide based MCRs is given in chapter 1 of this thesis and hence it will not be discussed here.

4.2.2.4 Reactions of coordinated isocyanides

The presence of non-bonding pair of electrons in *sp*-hybridized orbital on the terminal carbon enables isocyanides to behave as strong carbon ligand for transition metals. For example, formation of the carbodiimide **27** by the reaction of primary amines and isocyanides *via* the formation of the carbon co-ordinated Pd(II) complex **26** is shown below (Scheme 12).¹⁵

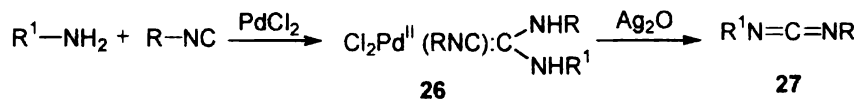

Scheme 12

Isocyanide-nickel complexes such as **28** react with diphenyl acetylene **29** to form diiminocyclobutene derivative **30**. However, in presence of Pd complexes, isocyanide reacts with diphenyl acetylene to form imino cyclopentadiene **31** by a [1+2+2] cycloaddition as shown below (Scheme 13).¹⁶

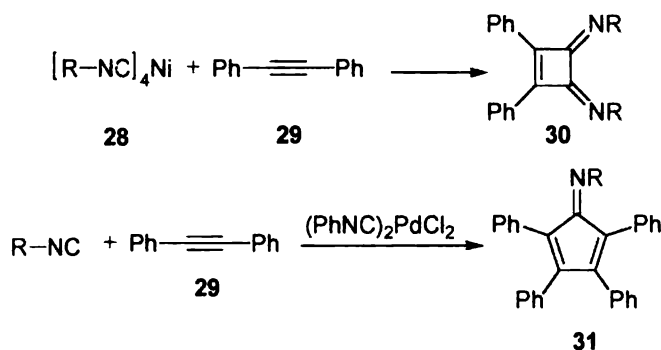

Scheme 13

4.2.2.5 Miscellaneous reactions

There are a variety of reactions of isocyanides that cannot be restricted to any one of the above categories. These include isocyanide addition to carbonyl compounds,¹⁷ addition to olefins¹⁸ and reaction with 1,3-dipoles. Activation by Lewis acids is necessary for the addition of isocyanides to carbonyl compounds while addition to olefins occurs readily to form zwitterionic species which can undergo further reactions to form various products. The reaction of 1,3-dipoles with isocyanides will be discussed here.

Isocyanides act as a one carbon synthon, which on annulation by a 1,3-dipole should furnish four membered ring systems. Nitrile ylides have been shown to produce four membered rings **33** on reaction with isocyanides (Scheme 14).¹⁹

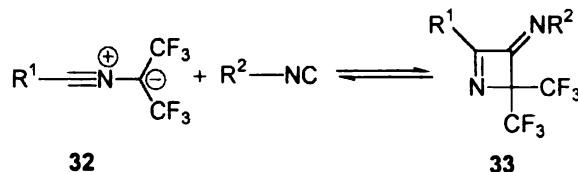

Scheme 14

Azomethine ylide **35**, generated by the thermal ring opening of aziridine **34**, has been successfully cyclized with isocyanides to give the 3-iminoazetidines **36** (Scheme 15).²⁰

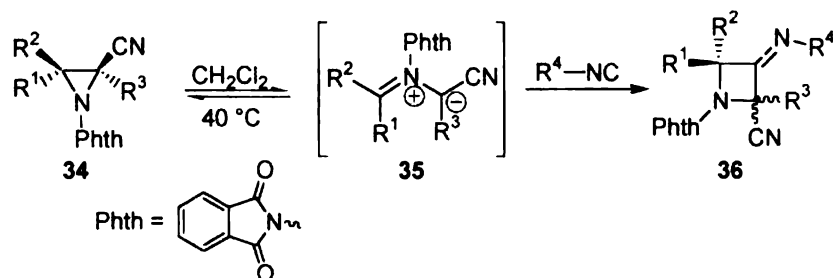

Scheme 15

Nitrones have also been added to isocyanides. Moderhack and Lorke have shown that using boron trifluoride as a catalyst, dialkyl nitrones **37** are readily cyclized with isocyanides to yield 4-imino-1,2-oxazetidines **38** (Scheme 16).²¹

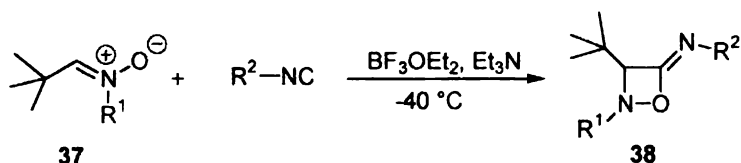

Scheme 16

Isocyanides add to benzyne to generate 1,3-dipolar species which can either get protonated or add to other electrophiles present in the system. Knorr showed that the reaction of cyclohexyl isocyanide with benzenediazonium-2-carboxylate **39** as a benzyne precursor in *tert*-butanol produced *N*-cyclohexylbenzamide and isobutene, concomitant with the evolution of CO₂ and N₂ gases (Scheme 17).²²

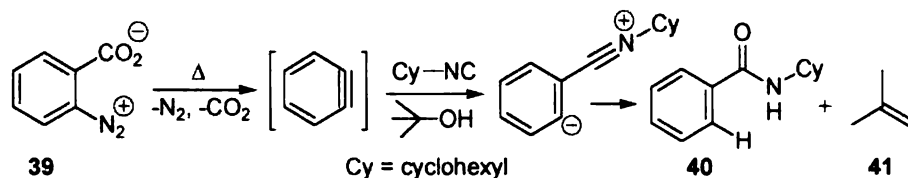

Scheme 17

A novel class of isocyanide based MCRs were developed in our laboratory based on the reactivity of the 1:1 intermediate formed by the reaction of isocyanide with dimethyl acetylenedicarboxylate. Earlier there have been few unsuccessful attempts to trap this reactive 1,3-dipolar intermediate.²³ Experiments in our laboratory have shown

that the 1,3-dipole **44** generated from cyclohexyl isocyanide **42** and DMAD **43** can be trapped with a variety of aldehydes, thus constituting a novel multicomponent aminofuran synthesis (Scheme 18).²⁴

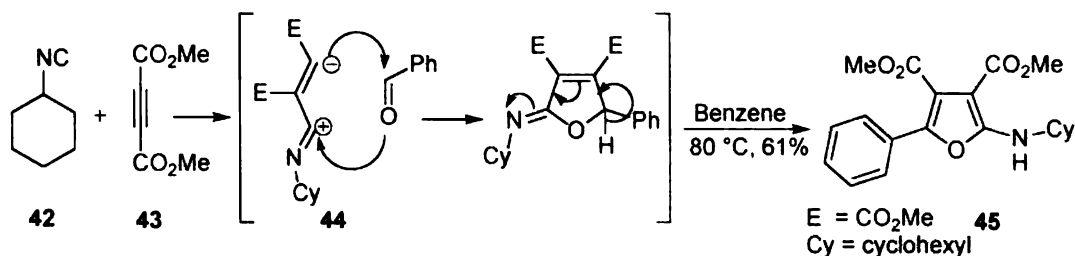

Various dipolarophiles like *N*-tosylimines, 1,2-dicarbonyl compounds, *o*- and *p*-quinones and quinoneimines were also reactive towards the dipole affording novel heterocyclic systems.²⁵ Recent work has also shown that activated double bonds of dicyanostyrenes can react with the dipole generated from isocyanide and DMAD to yield fully substituted cyclopentadiene derivatives as shown below (Scheme 19).²⁶

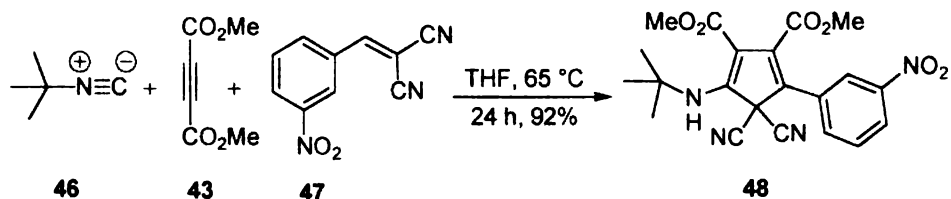

Recently, a three-component reaction involving isoquinoline, *gem*-diactivated olefins and isocyanides leading to the formation of dihydropyrroloisoquinoline systems **52** was reported by Mironov.²⁷ The reaction proceeds through the pentannulation of a Huisgen 1,4-dipole **51**, formed from isoquinoline and olefin, by isocyanide (Scheme 20).

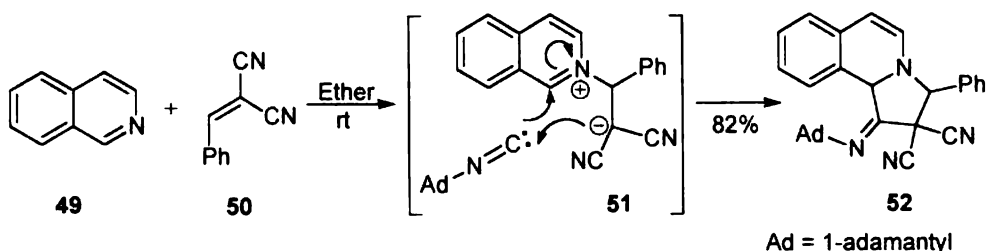

Scheme 20

A three-component reaction of isocyanides, arynes and aldehydes was reported very recently by Yoshida, constituting a straightforward synthesis of benzannulated iminofurans (Scheme 21).²⁸

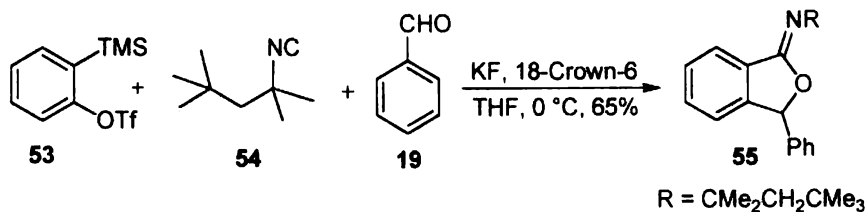

Scheme 21

Apart from the above mentioned reactions, isocyanides are also known to undergo [4+1] cycloadditions with suitable dienes.²⁹ Work from our laboratory has shown that [4+1] cycloaddition reactions of isocyanides can be used for the construction of 2-imino-1,3-oxathioles and furan annulated heterocycles by reaction with *o*-thioquinones and heterocyclic quinonemethides respectively.³⁰ The latter are in turn generated *in situ* by the reaction of active methylene compounds and aldehydes.

As the present chapter is focused on the addition of isocyanide-DMAD zwitterion to vicinal tricarbonyl compounds, a brief discussion of the latter will be appropriate in this context.

4.3 Vicinal tricarbonyl compounds

Vicinal tricarbonyl compounds refer to systems in which three carbonyl groups are arranged adjacently in an array. These have been known to synthetic organic chemists ever since the first preparation of diphenyl triketone in 1890 by Pechmann *et*

*al.*³¹ The synthetic importance of these systems is due to the reactivity of the highly electrophilic central carbonyl group of these molecules. Recent reviews by Wasserman and Rubin cover many aspects of the chemistry and applications of these species.³² The vicinal tricarbonyl (VTC) system may be prepared in high purity by a variety of procedures, some of which are outlined in the following sections.

4.3.1 Methods of preparation

4.3.1.1 From β -dicarbonyl compounds

Tricarbonyl compounds can be prepared by a variety of methods from β -dicarbonyl compounds by functionalizing the central carbon of the latter followed by an oxidation. Some of these methods are illustrated below (Scheme 22).³³⁻³⁶

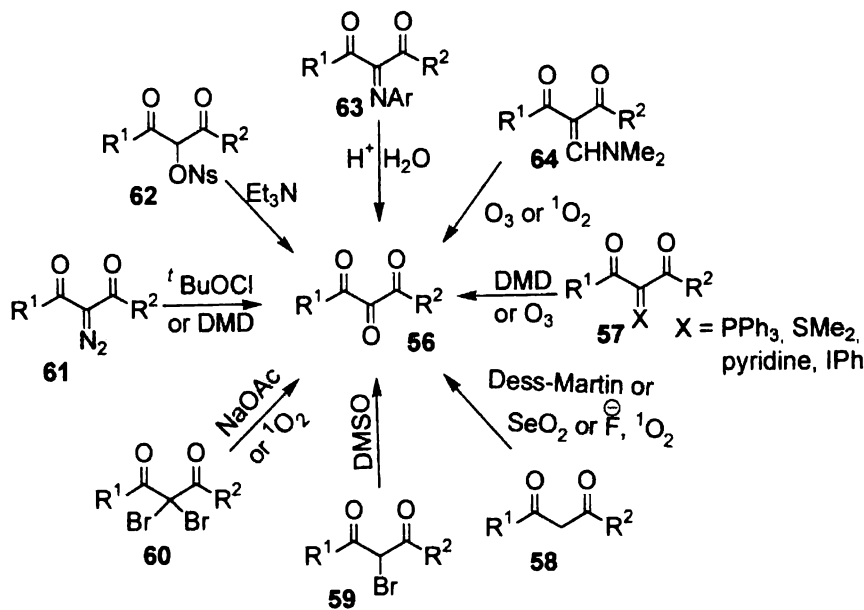

4.3.1.2 From monoketones

Tatsugi and Isawa³⁷ reported a one-pot bromination-oxidation sequence to convert 1- and 2- indanones **65** and **66** to ninhydrin **67** (Scheme 23).

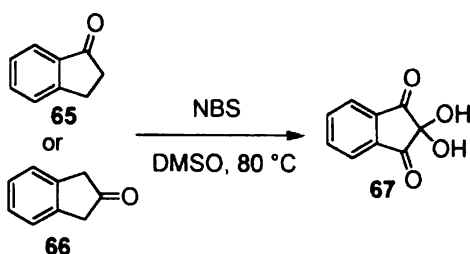

Scheme 23

4.3.1.3 SmI₂ mediated insertion of isocyanides

Reaction of alkyl bromides with isocyanides and esters³⁸ mediated by SmI₂ produced diimino compounds which could be hydrolyzed to tricarbonyls (Scheme 24).

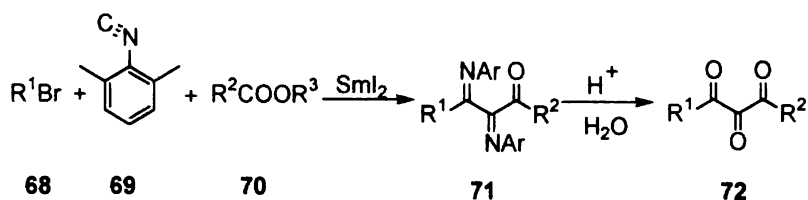

Scheme 24

4.3.1.4 Oxidation of dihydroxy precursors

Hirama and Ito³⁹ obtained the hydrate of *o*-troloquinone by the DDQ oxidation of 3-hydroxytropolone in acetonitrile followed by addition of water (Scheme 25).

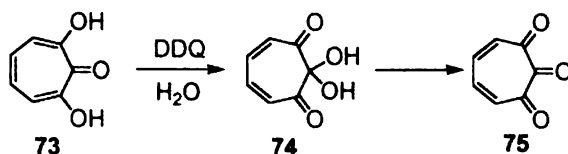

Scheme 25

The central carbonyl group of a vicinal tricarbonyl system is a highly electrophilic site due to the inherent coulombic repulsion between the carbonyl groups. So these can participate in several bond forming reactions, some of these are illustrated in the following section.

4.3.2 Reactions of tricarbonyl compounds

4.3.2.1 Reaction with nucleophiles

Exposure to moist air is sufficient to convert highly coloured polycarbonyls to their faintly coloured hydrates. The problem of hydration is particularly acute with cyclic compounds where the carbonyl groups are forced to near coplanar conformations.

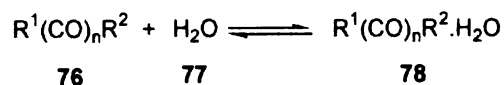

Scheme 26

A variety of procedures have been used to obtain the free carbonyl compound from its hydrate. These include heating in vacuum or sublimation, distillation, crystallization, treatment in solution with molecular sieves or chemical dehydrating agents such as phosphorus pentoxide. Azeotropic distillation with toluene or chlorobenzene followed by concentration has also been reported.⁴⁰ However, hydration is not a major problem in chemical reactions as in solution there is always some concentration of the free tricarbonyl compound.

Tricarbonyl compounds can readily undergo reaction with various nitrogen and carbon nucleophiles. Synthesis of papaveraldine⁴¹ **84**, an isoquinoline alkaloid, by the reaction of the trione **80** with 3,4-dimethoxy phenethylamine **79** is shown below (Scheme 27).

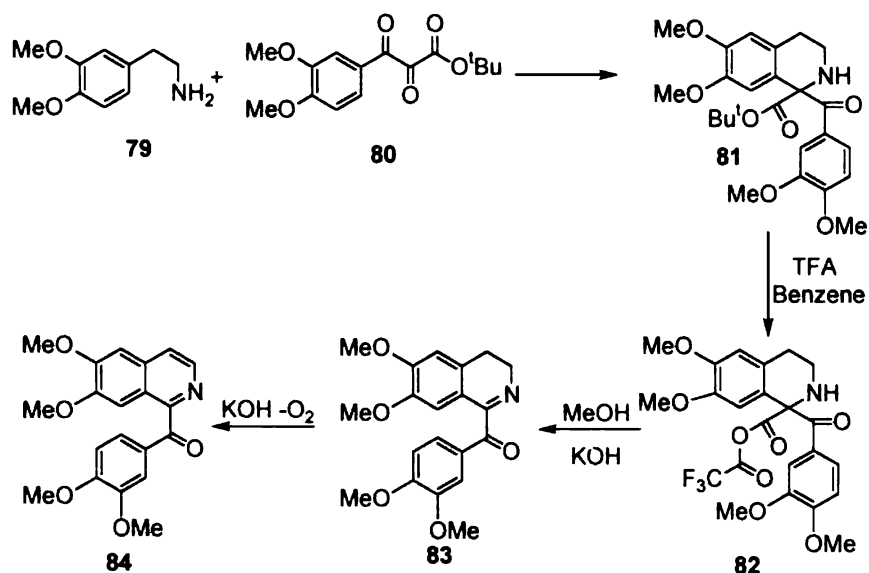

Scheme 27

A large number of enolizable β -dicarbonyl compounds, phenols, phosphorus ylides, enamines, alkoxy or hydroxy substituted anilines and malonic acids can react with vicinal polycarbonyls. Wasserman observed that reaction of the phosphorane, **87** with the vicinal trione **86** in ethyl acetate at 0 °C afforded the cyclopentenone, **88** (Scheme 28).⁴²

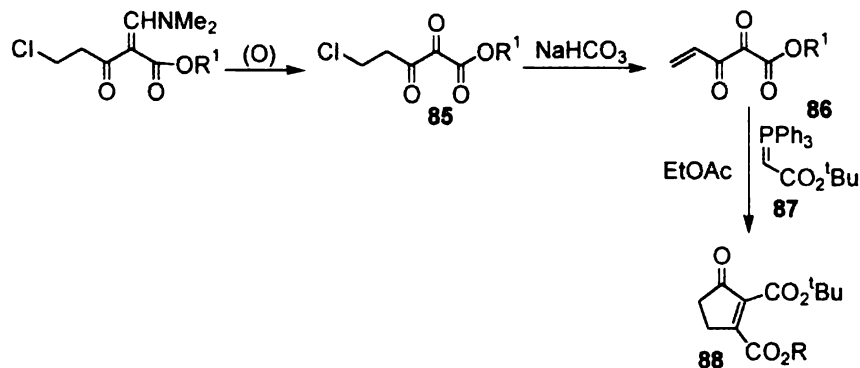

Scheme 28

4.3.2.2 Rearrangement reactions

Benzilic acid type rearrangements of the tricarbonyl compound have been applied for the conversion of the immunosuppressant FK 506 (masked α , β diketoamide) **89** into its rearranged product **91**. Partial structures are shown in scheme 29.⁴³

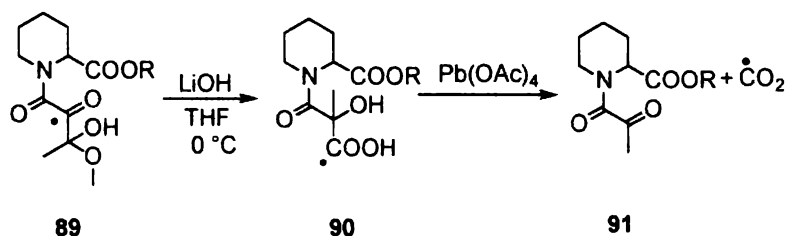

Scheme 29

Diacylcarbinol rearrangement of diphenyl triketone **92** with phenyl magnesium bromide resulted in the formation of benzoin **94** (Scheme 30).⁴⁴

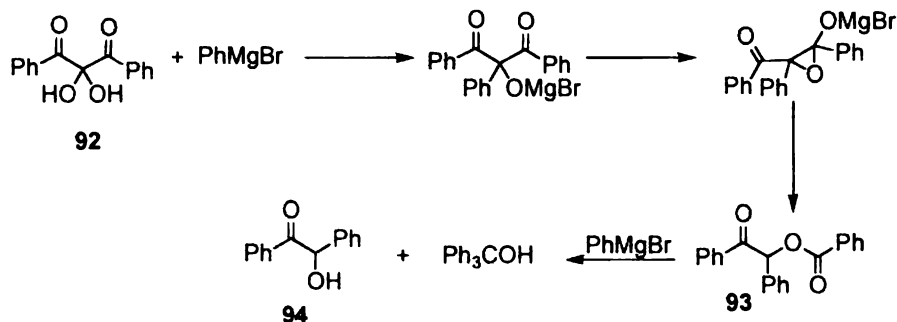

Scheme 30

4.3.2.3 Thermolysis

Flash vacuum thermolysis of cyclopentenetrione **95** at 430 °C produced cyclobutene dione **96** in 10% yield. Trapping of the intermediate bisketene with methanol gave good yields of dimethyl succinate (Scheme 31).⁴⁵

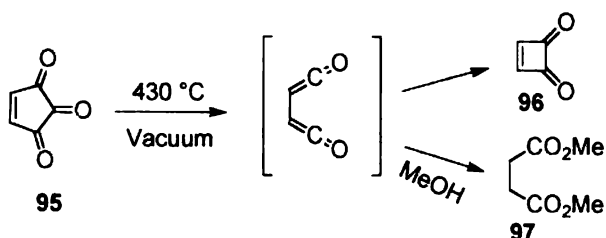

Scheme 31

4.3.2.4 Cycloaddition reactions

Tetrahydroindole derivative **100** has been prepared by the reaction of acylamino diene **98** with vinyl vicinal tricarbonyl **99** as shown below (Scheme 32).⁴⁶

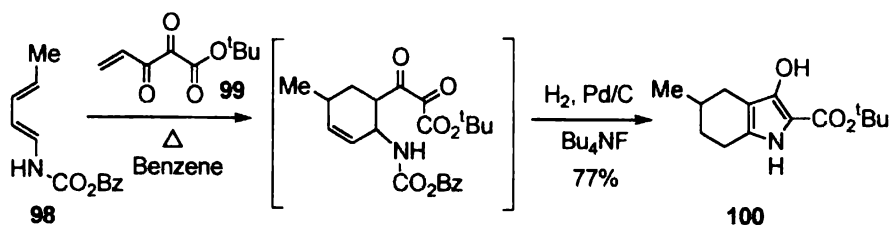

Scheme 32

4.3.3 Ninhydrin

Ninhydrin (1,2,3-triketo-hydrindene hydrate) **67** has been recognized for more than hundred years as a reagent for detecting amino acids. It is widely used as a spray reagent in the identification and quantitative estimation of amino acids. All α -amino acids react with ninhydrin to give a blue coloured product, except proline and hydroxy proline which give yellow products. Intensity of the colour is proportional to the amount of amino acid present. The reaction of ninhydrin with α -amino acids is given in scheme 33.

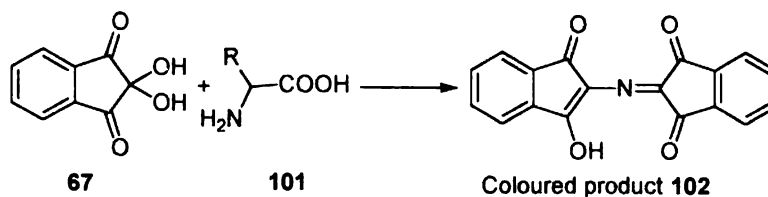

Scheme 33

During the mid nineteen fifties, it was discovered that ninhydrin could also be used to develop latent finger prints on paper and porous surfaces. When ninhydrin comes into contact with amino acids in fingerprint residue, the reaction yields a red to purple print. This has wide spread application in the forensic laboratories for the identification of finger prints for various purposes.

4.4 Statement of the problem

Although there are literature reports on the addition of a variety of nucleophiles to the trione unit, there have been no attempts to add zwitterionic species to it. Backed by our experience in the area of isocyanides, particularly addition of isocyanide-DMAD dipole to electrophilic carbonyl groups, we investigated the reaction of the isocyanide-DMAD zwitterion towards the vicinal tricarbonyls. Results of our investigations in this area are detailed below.

4.5 Results and Discussion

The tricarbonyl compounds selected for our studies are shown below (Figure 2).

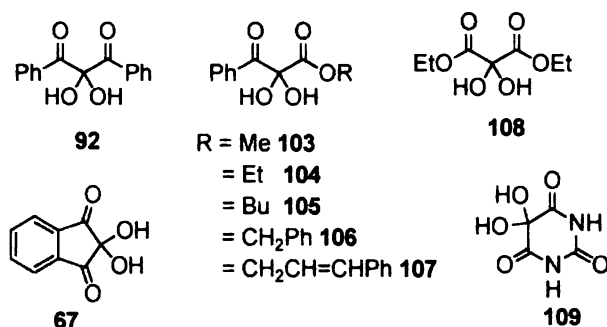
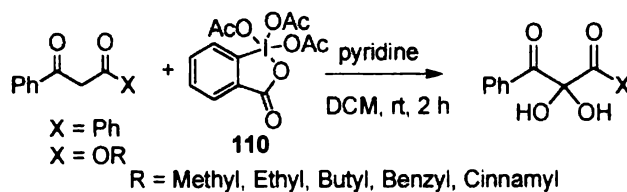

Figure 2

Diphenyl triketone hydrate **92** and the diketoester hydrates (**103-107**) were prepared by a reported procedure involving the oxidation of the corresponding 1,3-dicarbonyl compounds with Dess-Martin periodinane **110** as shown in scheme 34.⁴⁷ Alloxan hydrate **109** was obtained by the chromium trioxide oxidation of barbituric acid in acetic acid.⁴⁸ Diethyl ketomalonate **108** and ninhydrin **67** are commercially available.

**Scheme 34**

The 1,3-dicarbonyl compound was treated with Dess-Martin periodinane **110** in presence of pyridine in dry DCM. Processing of the reaction mixture followed by column chromatography of the crude mixture on silica gel yielded the corresponding tricarbonyl compound in moderate yields.

In a pilot experiment, a solution of the diketoester **104** and DMAD **43** in dry dichloromethane was treated with *tert*-butyl isocyanide **46** at room temperature. After completion of the reaction, as indicated by TLC, the reaction mixture was processed, and the residue was subjected to column chromatography on silica gel to afford the fully substituted furan **111** as a colourless liquid in 56% yield (Scheme 35).

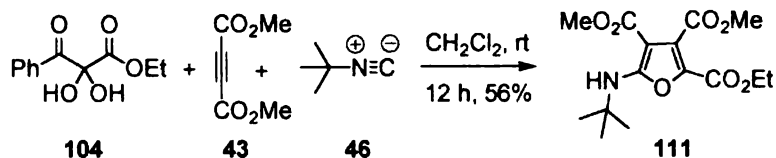
**Scheme 35**

The IR spectrum of **111** displayed characteristic ester carbonyl and N-H vibrations at 1743, 1722 and 3345 cm^{-1} . In the ^1H NMR spectrum, sharp singlet at δ 1.47 was characteristic of the *tert*-butyl group while the methoxy protons of the ester moiety resonated at δ 3.90 and 3.76. The N-H proton was discernible as a sharp singlet at δ 6.99 and was exchangeable with D_2O . In the ^{13}C NMR spectrum, the ester carbonyl carbons were discernible at δ 164.8, 163.8 and 162.2. The compound gave satisfactory mass analysis also.

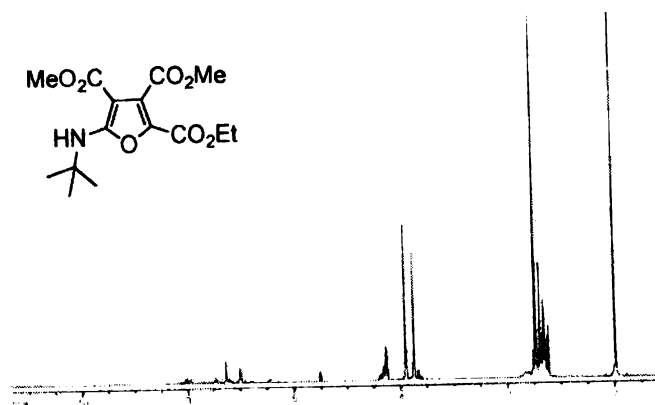

Figure 3 ¹H NMR spectrum of compound 111

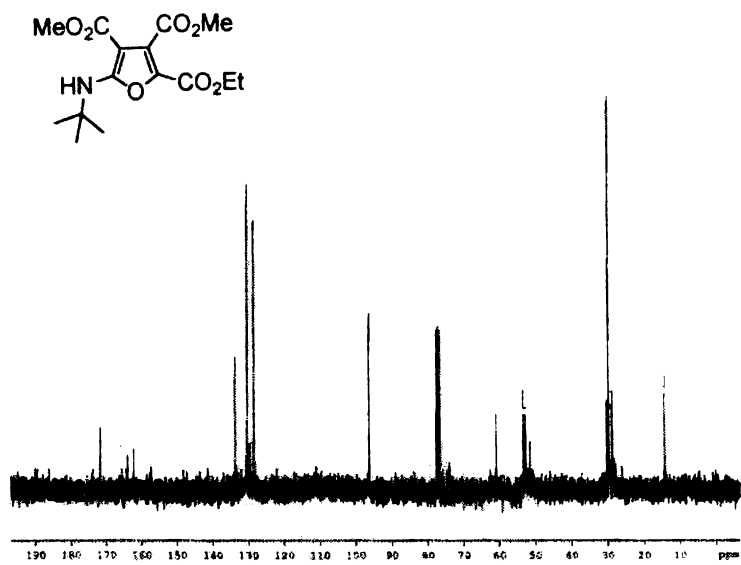

Figure 4 ¹³C NMR spectrum of compound 111

To test the generality of the reaction, a number of diketoesters were prepared and were subjected to the same reaction conditions with isocyanide and DMAD in dichloromethane as solvent. In all these cases the reaction afforded the aminofuran derivatives in moderate yields. The results are summarized in table 1.

Table 1

Entry	Diketoester	Product	Yield (%) ^a
1	103 R = Me	112	62
2	105 R = Bu	113	57
3	106 R = CH ₂ Ph	114	49
4	107 R = CH ₂ CH=CHPh	115	50

^aIsolated Yield

The reaction was also found to be variable with respect to the isocyanide component. Cyclohexyl isocyanide and DMAD reacted with the diketoesters leading to the substituted furans in moderate yields and the results are catalogued in table 2.

Table 2

Entry	Diketoester	Product	Yield (%) ^a
1	103 R = Me	116	51
2	104 R = Et	117	58
3	105 R = Bu	118	60
4	106 R = CH ₂ Ph	119	37
5	107 R = CH ₂ CH=CHPh	120	45

^aIsolated Yield

A different kind of reaction occurred when a solution of diphenyl triketone **92** and DMAD **43** in dry dichloromethane was treated with *tert*-butyl isocyanide **46** at room temperature. After completion of the reaction, as indicated by TLC, the reaction mixture was processed and the residue was subjected to column chromatography on silica gel to afford **121** as a viscous liquid in 42% yield. It was clear from the ^1H NMR spectrum of the compound that it contained two isocyanide molecules per molecule of DMAD and the trione. The reaction conditions were modified accordingly using two equivalents of the isocyanide and the reaction was found to yield the same iminopyrone **121** in 83% yield. Similar reaction with cyclohexyl isocyanide afforded **122** (Scheme 36).

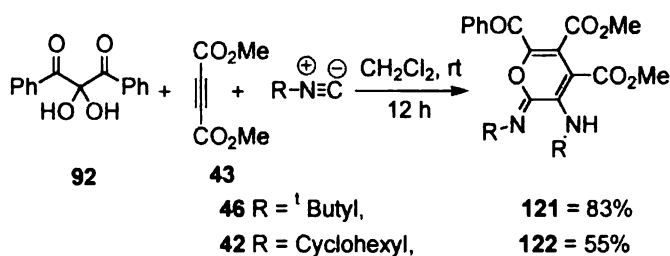

Scheme 36

The product was characterized on the basis of spectroscopic data. The IR spectrum of **121** displayed characteristic ester and benzoyl carbonyl vibrations at 1741 and 1681 cm^{-1} respectively. In the ^1H NMR spectrum sharp singlets at δ 1.51 and 1.38 corresponded to the two *tert*-butyl groups and the protons of the carbomethoxy groups resonated at δ 3.87 and 3.66. The N-H proton was discernible at δ 6.79 and it was exchangeable with D_2O . ^{13}C resonance signals at δ 185.6, 163.8 and 162.3 were characteristic of the benzoyl and ester carbonyl carbons respectively. Mass spectral data also agreed with the proposed structure.

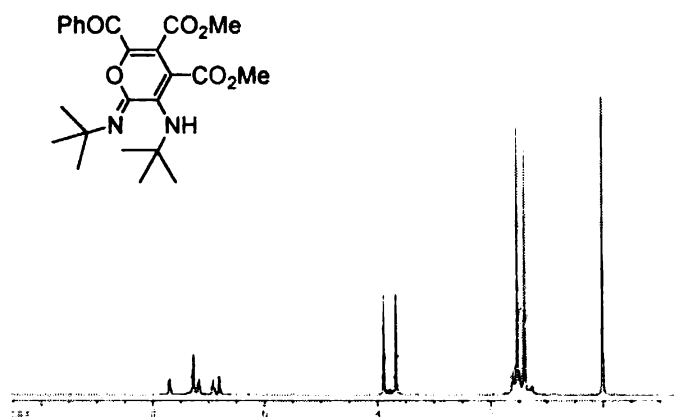

Figure 5 ¹H NMR spectrum of compound 121

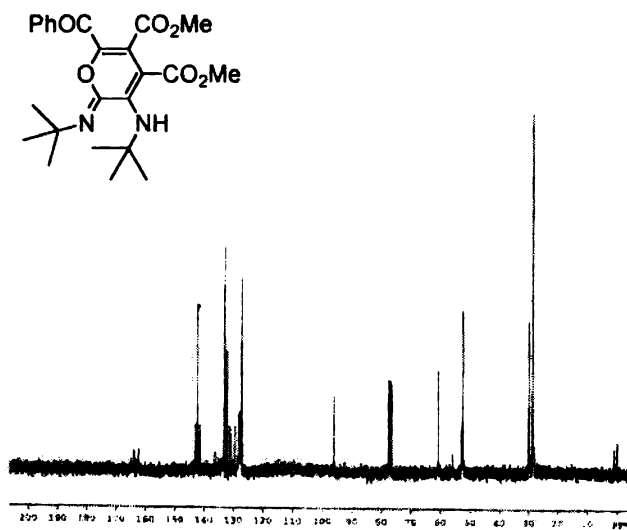
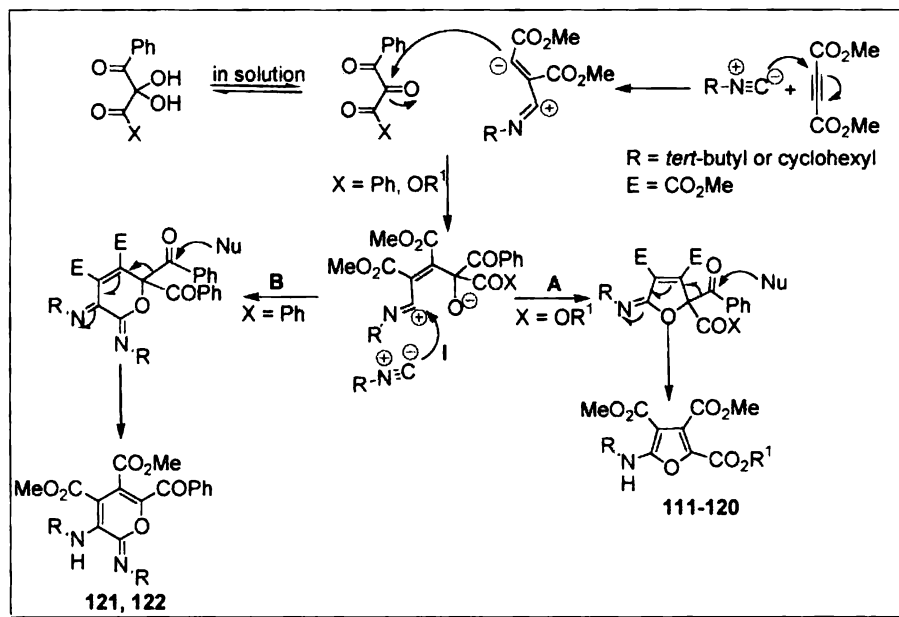

Figure 6 ¹³C NMR spectrum of compound 121

A mechanistic rationale for the reaction sequence can be outlined as shown in scheme 37. Vicinal tricarbonyl compounds in solution are known to be in equilibrium with their hydrates. Nucleophilic addition of the isocyanide-DMAD zwitterion to the central carbonyl of the trione leads to the formation of the tetrahedral intermediate **I** which in turn can cyclize according to path **A** to form the iminofuran. This is followed by the debenzoylation of the iminofuran probably by the attack of the water molecule present in the system to yield the aminofuran. The formation of the iminopyrone may be rationalized as occurring *via* path **B**. Presumably the steric effect imposed by the two benzoyl groups prevents the closure of the oxanion in the intermediate **I** and allows the approach of another isocyanide molecule to participate in the reaction.

The participation of two isocyanide molecules in the reaction of diphenyl triketone **92** with isocyanide and DMAD is an example of a one-pot three-compound, pseudo four-component reaction.



Scheme 37

The reaction of diethyl ketomalonate **108** with DMAD and isocyanide was found to be ineffective in generating the substituted furan indicating that at least one additional ketone functionality is necessary for the reaction to occur.

Subsequently, the reactivity of the zwitterion towards cyclic tricarbonyl compounds was examined. First, when we attempted the reaction of ninhydrin **67** with isocyanide and DMAD, under the same reaction conditions, only intractable mixtures could be observed. It was speculated that this is due to the high reactivity of ninhydrin in comparison to open chain tricarbonyl compounds. Therefore alloxan hydrate **109**, another cyclic tricarbonyl compound with a much less reactive central carbonyl, was chosen for the study.

It was observed that alloxan hydrate **109**, on reaction with DMAD and isocyanide in dry dichloromethane led to the formation of the spiroadduct **123** albeit in low yield (Scheme 38).

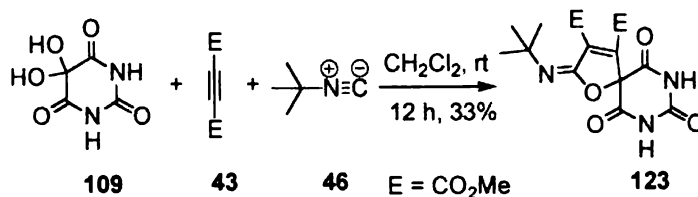

Scheme 38

The product **123** was characterized by spectroscopic analysis. The IR spectrum displayed characteristic ester and amide carbonyl stretchings at 1738 and 1665 cm⁻¹ respectively. In the ¹H NMR spectrum, the protons of the carbomethoxy group were discernible at δ 3.77 and 3.72 while the signal due to *tert*-butyl protons appeared at δ 1.43. The ¹³C resonance signals of the amide carbonyls were observed around δ 172.0 while the ester carbonyls were discernible at δ 165.3 and 164.8.

4.6 Conclusion

In conclusion, a novel reaction of tricarbonyl compounds with the isocyanide-DMAD zwitterion which led to a convenient one-pot synthesis of tetra-substituted

furans and iminopyrones was discovered. Substituted furans are useful intermediates in synthetic organic chemistry⁴⁹ and there have been numerous approaches towards their synthesis.⁵⁰ It is noteworthy that the reaction occurs at room temperature and allows the introduction of all functional groups in a single step. To the best of our knowledge, this is the first report of the interception of the carbonyl group of the tricarbonyl system with zwitterionic species.

4.7 Experimental Details

General information about experiments is given in section 2 of Chapter 2. Cyclohexyl isocyanide was prepared by a reported procedure. Tricarbonyl compounds were prepared by a known literature procedure given below.

Synthesis of 1,3-Dicarbonyl Compounds

The 1,3-dicarbonyls, required as starting materials, were prepared by the following procedure. To a solution of diisopropylamine (2.2 g, 0.02 mol) in dry THF at $-78\text{ }^{\circ}\text{C}$, was added *n*-BuLi (1.34 g, 0.02 mol) rapidly but slowly. After complete addition, the temperature was brought to $-10\text{ }^{\circ}\text{C}$ by immersion in an ice-salt bath for 15 minutes. The mixture was re-cooled to $-78\text{ }^{\circ}\text{C}$ and the acetate (0.02 mol) was added dropwise. This is followed by the dropwise addition of benzoyl chloride in THF (1 g, 0.007 mol). The reaction mixture was allowed to warm to room temperature. After completion, it was diluted with 10% aqueous HCl and extracted with ether (3 times). Combined organic extracts was dried over anhydrous sodium sulphate. The solvent was distilled off and the residue was subjected to silica gel column chromatography. Elution with hexanes-ethyl acetate (95:5) solvent mixture afforded the 1,3-dicarbonyl compounds in good yields which were used for the next step.

Synthesis of 1,2,3-Tricarbonyl compounds⁴⁷

To the suspension of Dess-Martin periodinane (1 g, 3.2 mmol), (prepared freshly from IBX) in dry DCM was added pyridine (0.26 g, 3.33 mmol) and stirred till the solution becomes clear. This is followed by the addition of the 1,3-dicarbonyl compound (1 mmol) and the mixture was stirred for 12 h. After completion, the

reaction mixture was diluted and extracted with DCM (3 x 10 mL). The organic layer was washed with saturated solutions of sodium thiosulphate (10 mL), sodium bicarbonate (10 mL) and copper (II) sulphate (10 mL). Combined organic layer was finally dried over anhydrous sodium sulphate. The solvent was distilled off in a rotary evaporator and the residue was subjected to column chromatography on silica gel. Elution with hexanes-ethylacetate (85:15) solvent mixture yielded the tricarbonyl hydrates. The same procedure was followed for the preparation of diphenyl triketone and triketo esters.

Alloxan hydrate was prepared by the chromium trioxide oxidation of barbituric acid.⁴⁸ To 2.4 g chromium trioxide in acetic acid-water mixture was added 2 g barbituric acid. The mixture was cooled to 5-10 °C and stirred for an hour. Alloxan hydrate (2 g) was filtered and washed with acetic acid and finally with ether, mp 254-255 °C.

General Procedure for the Reaction of Diketoesters with Isocyanide and DMAD

A solution of dimethyl acetylenedicarboxylate (114 mg, 0.80 mmol) and diketoester (0.67 mmol) in 10 mL anhydrous CH₂Cl₂ was stirred for 2 minutes. To this solution, *tert*-butyl or cyclohexyl isocyanide (0.80 mmol) was added *via* a syringe and the reaction mixture was allowed to stir at room temperature for 12 h. On completion of the reaction, solvent was distilled off using a rotary evaporator and the residue was subjected to chromatography on silica gel column using hexanes-ethylacetate solvent mixture (90:10) to afford pure products.

3,4-Dimethyl-2-ethyl-5-(*tert*-butylamino) furan-2,3,4-tricarboxylate 111

To a solution of DMAD **43** (114 mg, 0.80 mmol) and the diketoester **104** (150 mg, 0.67 mmol) was added *tert*-butyl isocyanide **46** (67 mg, 0.80 mmol) and stirred. Processing of the reaction mixture as described in the general procedure afforded the fully substituted furan **111** as a colourless liquid (123 mg, 56%).

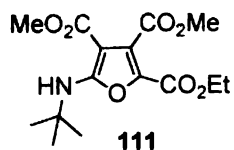

IR (thin film) ν_{\max} : 3345, 2969, 1743, 1722, 1614, 1537, 1459, 1322, 1262, 1217, 1094, 1052 cm^{-1} .

^1H NMR: δ 6.99 (s, 1H, D_2O exchangeable), 4.31-4.24 (q, 2H, $J = 7.20$ Hz), 3.90 (s, 3H), 3.76 (s, 3H), 1.47 (s, 9H), 1.35-1.32 (t, 3H, $J = 4.89$ Hz).

^{13}C NMR: δ 164.8, 163.8, 162.2, 157.3, 133.5, 130.2, 129.5, 128.4, 60.7, 53.2, 52.6, 51.3, 29.5, 14.2.

Mass spectrometric analysis (HRMS-EI) m/z calcd for $\text{C}_{15}\text{H}_{21}\text{NO}_7$: 327.1316; found: 327.1333.

3,4-Dimethyl-2-methyl-5-(*tert*-butylamino) furan-2,3,4-tricarboxylate **112**

To a solution of DMAD **43** (114 mg, 0.80 mmol) and the diketoeester **103** (141 mg, 0.67 mmol) was added *tert*-butyl isocyanide **46** (67 mg, 0.80 mmol) and stirred. Processing of the reaction mixture as described in the general procedure afforded the fully substituted furan **112** as a colourless liquid (130 mg, 62%).

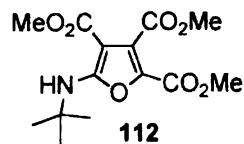

IR (thin film) ν_{\max} : 3353, 2957, 1751, 1731, 1605, 1490, 1435, 1370, 1340, 1265, 1225, 1154 cm^{-1} .

^1H NMR: δ 7.01 (s, 1H, D_2O exchangeable), 3.92 (s, 3H), 3.82 (s, 3H), 3.76 (s, 3H), 1.47 (s, 9H).

^{13}C NMR: δ 164.2, 163.8, 162.1, 157.7, 133.5, 130.1, 128.7, 128.4, 89.1, 53.3, 52.8, 51.8, 51.4, 29.7.

Mass spectrometric analysis (HRMS-EI) m/z calcd for $\text{C}_{14}\text{H}_{19}\text{NO}_7$: 313.1162; found: 313.1139.

2-Butyl-3,4-dimethyl-5-(*tert*-butylamino) furan-2,3,4-tricarboxylate **113**

To a solution of DMAD **43** (114 mg, 0.80 mmol) and the diketoeester **105** (168 mg, 0.67 mmol) in anhydrous CH_2Cl_2 was added *tert*-butyl isocyanide **46** (67 mg, 0.80 mmol) and stirred. The reaction mixture was processed in the usual manner to afford the fully substituted furan **113** as a colourless liquid (134 mg, 57%).

IR (thin film) ν_{\max} : 3348, 2958, 2927, 2871, 1748, 1727, 1614, 1531, 1449, 1435, 1372, 1325, 1269, 1217, 1135, 1049, 1063 cm^{-1} .

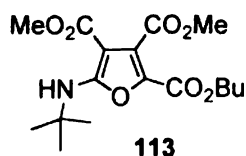

^1H NMR: δ 6.99 (s, 1H, D_2O exchangeable), 4.24-4.21 (m, 2H), 3.90 (s, 3H), 3.76 (s, 3H), 3.62-3.61 (m, 2H), 1.68-1.64 (m, 2H), 1.48 (s, 9H), 0.98-0.93 (t, 3H, $J = 11.1$ Hz).

^{13}C NMR: δ 164.2, 162.2, 133.7, 130.0, 128.5, 126.1, 66.1, 64.5, 53.2, 52.6, 51.4, 30.1, 29.5, 28.4, 19.0, 13.7.

Mass spectrometric analysis (HRMS-EI) m/z calcd for $\text{C}_{17}\text{H}_{25}\text{NO}_7$: 355.1631; found: 355.1625.

2-Benzyl-3,4-dimethyl-5-(*tert*-butylamino) furan-2,3,4-tricarboxylate **114**

To a solution of DMAD **43** (114 mg, 0.80 mmol) and the diketoester **106** (191 mg, 0.67 mmol) in anhydrous CH_2Cl_2 was added *tert*-butyl isocyanide **46** (67 mg, 0.80 mmol) and stirred. Usual processing of the reaction mixture afforded the fully substituted furan **114** as a colourless liquid (116 mg, 49%).

IR (thin film) ν_{\max} : 3353, 2933, 2850, 1748, 1727, 1609, 1496, 1367, 1264, 1212, 1135, 1094 cm^{-1} .

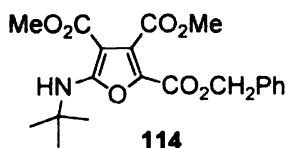

^1H NMR: δ 7.24-7.02 (m, 5H), 7.02 (s, 1H, D_2O exchangeable), 5.24-5.16 (m, 2H), 3.97 (s, 3H), 3.76 (s, 3H), 1.47 (s, 9H).

^{13}C NMR: δ 164.2, 163.0, 162.3, 133.5, 130.6, 129.5, 128.7, 128.5, 127.6, 126.0, 113.2, 109.6, 108.8, 66.5, 53.3, 52.5, 51.4, 41.8, 29.6.

2-Cinnamyl-3,4-dimethyl-5-(*tert*-butylamino) furan-2,3,4-tricarboxylate **115**

To a solution of DMAD **43** (114 mg, 0.80 mmol) and the diketoester **107** (210 mg, 0.67 mmol) in anhydrous CH_2Cl_2 was added *tert*-butyl isocyanide **46** (67 mg, 0.80 mmol) and stirred. Usual processing of the reaction mixture led to the fully substituted furan **115** as a colourless liquid (139 mg, 50%).

IR (thin film) ν_{\max} : 3350, 2959, 1743, 1727, 1676, 1609, 1485, 1454, 1372, 1331, 1259, 1212, 1140, 1088, 1047, 970 cm^{-1} .

^1H NMR: δ 7.44-7.26 (m, 5H), 7.03 (s, 1H, D_2O exchangeable), 6.72-6.66 (d, 1H, $J = 16.2$ Hz), 6.33-6.26 (m, 1H), 4.95-4.87 (m, 2H), 3.87 (s, 3H), 3.76 (s, 3H), 1.48 (s, 9H).

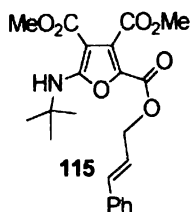

^{13}C NMR: δ 164.0, 163.8, 162.3, 141.4, 136.2, 134.1, 133.5, 130.2, 129.1, 128.7, 128.0, 126.7, 126.6, 122.8, 121.9, 66.8, 53.3, 52.7, 51.9, 39.4, 29.4.

Mass spectrometric analysis (HRMS-EI) m/z calcd for $\text{C}_{22}\text{H}_{25}\text{NO}_7$: 415.1631; found: 415.1655.

3,4-Dimethyl-2-methyl-5-(cyclohexylamino) furan-2,3,4-tricarboxylate **116**

To a solution of DMAD **43** (114 mg, 0.80 mmol) and the diketoester **103** (141 mg, 0.67 mmol) in anhydrous CH_2Cl_2 was added cyclohexyl isocyanide **42** (87 mg, 0.80 mmol) and stirred. Usual processing of the reaction mixture led to the fully substituted furan **116** as a colourless liquid (116 mg, 51%).

IR (thin film) ν_{\max} : 3350, 2953, 2851, 1750, 1731, 1669, 1480, 1434, 1352, 1264, 1243, 1146 cm^{-1} .

^1H NMR: δ 6.82 (s, 1H, D_2O exchangeable), 3.92 (s, 3H), 3.82 (s, 3H), 3.76 (s, 3H), 3.58 (bs, 1H), 2.93-1.96 (m, 2H), 1.76-1.63 (m, 4H), 1.55-1.25 (m, 4H).

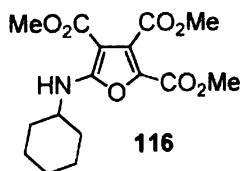

^{13}C NMR: δ 163.8, 162.9, 162.5, 133.5, 130.2, 128.8, 110.7, 52.7, 51.4, 50.8, 40.2, 33.4, 32.7, 29.7, 26.1, 25.4.

Mass spectrometric analysis (HRMS-EI) m/z calcd for $\text{C}_{16}\text{H}_{21}\text{NO}_7$: 339.1318; found: 339.1339.

3,4-Dimethyl-2-ethyl-5-(cyclohexylamino) furan-2,3,4-tricarboxylate **117**

To a solution of DMAD **43** (114 mg, 0.80 mmol) and the diketoester **104** (150 mg, 0.67 mmol) in anhydrous CH_2Cl_2 was added cyclohexyl isocyanide **42** (87 mg, 0.80 mmol) and stirred. Usual processing of the reaction mixture led to the fully substituted furan **117** as a colourless liquid (137 mg, 58%).

IR (thin film) ν_{max} : 3348, 2928, 2850, 1748, 1722, 1614, 1480, 1449, 1387, 1305, 1233, 1135 cm^{-1} .

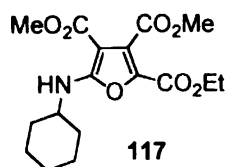

^1H NMR: δ 6.80 (s, 1H, D_2O exchangeable), 4.31-4.24 (q, 2H, $J = 7.20$ Hz), 3.90 (s, 3H), 3.76 (s, 3H), 3.69 (s, 1H), 2.03-1.79 (m, 2H), 1.76-1.61 (m, 2H), 1.61-1.39 (m, 2H), 1.36-1.25 (m, 7H).

^{13}C NMR: δ 164.1, 161.9, 133.5, 132.0, 129.5, 128.4, 118.3, 60.8, 54.7, 53.3, 52.6, 51.4, 33.4, 32.8, 24.7, 24.4, 14.2.

Mass spectrometric analysis (HRMS-EI) m/z calcd for $\text{C}_{17}\text{H}_{23}\text{NO}_7$: 353.1475; found: 353.1481.

2-Butyl-3,4-dimethyl-5-(cyclohexylamino) furan-2,3,4-tricarboxylate **118**

To a solution of DMAD **43** (114 mg, 0.80 mmol) and the diketoester **105** (168 mg, 0.67 mmol) in anhydrous CH_2Cl_2 was added cyclohexyl isocyanide **42** (87 mg, 0.80 mmol) and stirred. Usual processing of the reaction mixture led to the fully substituted furan **118** as a colourless liquid (153 mg, 60%).

IR (thin film) ν_{max} : 3353, 2933, 2852, 1745, 1721, 1615, 1485, 1465, 1255, 1225, 1150, 1109 cm^{-1} .

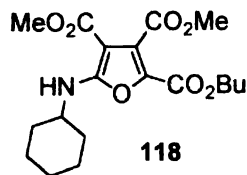

^1H NMR: δ 6.79 (s, 1H, D_2O exchangeable), 4.22 (t, 2H, $J = 12.9$ Hz), 3.89 (s, 3H), 3.76 (s, 3H), 2.03-1.99 (m, 2H), 1.74-1.61 (m, 5H), 1.45-1.25 (m, 8H), 0.98-0.90 (m, 3H).

^{13}C NMR: δ 164.0, 163.7, 161.9, 157.5, 133.7, 130.0, 128.6, 66.2, 52.6, 51.2, 33.3, 32.8, 30.4, 29.7, 25.4, 25.3, 24.7, 18.9,

13.7.

Mass spectrometric analysis (HRMS-EI) m/z calcd for $C_{19}H_{27}NO_7$: 381.1788; found: 381.1769.

2-Benzyl-3,4-Dimethyl-5-(cyclohexylamino) furan-2,3,4-tricarboxylate **119**

To a solution of DMAD **43** (114 mg, 0.80 mmol) and the diketoester **106** (191 mg, 0.67 mmol) in anhydrous CH_2Cl_2 was added cyclohexyl isocyanide **42** (87 mg, 0.80 mmol) and stirred. Usual processing of the reaction mixture led to the fully substituted furan **119** as a colourless liquid (103 mg, 37%).

IR (thin film) ν_{max} : 3380, 2933, 2847, 1736, 1721, 1666, 1621, 1560, 1500, 1460 cm^{-1} .

1H NMR: δ 7.25-7.01 (m, 5H), 6.89 (s, 1H, D_2O exchangeable), 5.31-5.12 (m, 2H), 3.77 (s, 3H), 3.62 (s, 3H), 3.57 (bs, 1H), 1.93-1.77 (m, 5H), 1.45-1.25 (m, 5H).

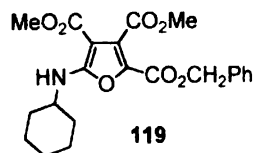

^{13}C NMR: δ 163.4, 162.0, 161.8, 133.7, 132.1, 129.6, 128.8, 128.1, 110.1, 107.3, 68.0, 53.3, 52.8, 51.5, 48.8, 41.6, 38.6, 33.3, 32.8, 29.7, 29.4, 26.4, 26.0.

Mass spectrometric analysis (HRMS-EI) m/z calcd for $C_{22}H_{25}NO_7$: 415.1631; found: 415.1666.

2-Cinnamyl-3,4-Dimethyl-5-(cyclohexylamino) furan-2,3,4-tricarboxylate **120**

To a solution of DMAD **43** (114 mg, 0.80 mmol) and the diketoester **107** (210 mg, 0.67 mmol) in anhydrous CH_2Cl_2 was added cyclohexyl isocyanide **42** (87 mg, 0.80 mmol) and stirred. Usual processing of the reaction mixture led to the fully substituted furan **120** as a colourless liquid (133 mg, 45%).

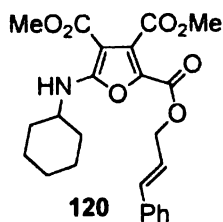

IR (thin film) ν_{\max} : 3348, 2957, 2926, 1742, 1727, 1616, 1600, 1475, 1424, 1382, 1330, 1239, 1200, 1140, 1077, 1035 cm^{-1} .

^1H NMR: δ 7.49-7.25 (m, 5H), 6.83 (s, 1H, D_2O exchangeable), 6.71-6.66 (d, 1H, $J = 16.5$ Hz), 6.47-6.26 (m, 1H), 4.89-4.87 (m, 2H), 3.82 (s, 3H), 3.69 (s, 3H), 3.57 (bs, 1H), 2.00-1.63 (m, 5H), 1.45-1.17 (m, 5H).

^{13}C NMR: δ 164.0, 162.8, 162.3, 140.4, 135.2, 134.4, 133.4, 130.3, 128.6, 126.7, 126.4, 121.7, 121.6, 66.7, 53.6, 52.8, 51.3, 48.8, 41.5, 38.6, 33.3, 32.6, 29.2, 29.3, 26.3, 26.1.

Mass spectrometric analysis (HRMS-EI) m/z calcd for $\text{C}_{24}\text{H}_{27}\text{NO}_7$: 441.1788; found: 441.1797.

General Procedure for the Reaction of Diphenyl triketone with Isocyanide and DMAD

A solution of dimethyl acetylenedicarboxylate (114 mg, 0.80 mmol) and diphenyl triketone (171 mg, 0.67 mmol) in 10 mL anhydrous CH_2Cl_2 was stirred for 2 minutes. To this solution, *tert*-butyl or cyclohexyl isocyanide (1.6 mmol) was added *via* a syringe and the reaction mixture was allowed to stir at room temperature for 12 h. On completion of the reaction, solvent was distilled off and the residue was subjected to chromatography on silica gel column using hexanes-ethylacetate solvent mixture (90:10) to afford pure products.

Dimethyl-(2E)-6-benzoyl-3-(*tert*-butylamino)-2-(*tert*-butylimino)-2H-pyran-4,5-dicarboxylate **121**

To a solution of DMAD **43** (114 mg, 0.80 mmol) and diphenyl triketone **92** (171 mg, 0.67 mmol) in anhydrous CH_2Cl_2 was added *tert*-butyl isocyanide **46** (133 mg, 1.60 mmol) and stirred. Processing of the reaction mixture as described above afforded the fully substituted pyran **121** as an amorphous solid (246 mg, 83%).

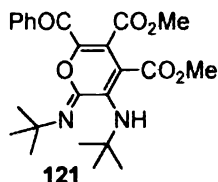

IR (thin film) ν_{\max} : 3333, 2976, 1741, 1681, 1475, 1365, 1336, 1221, 1082 cm^{-1} .

^1H NMR: δ 7.68 (d, 1H, $J = 7.9$ Hz), 7.27-7.26 (m, 2H), 7.16 (t, 1H, $J = 7.4$ Hz), 6.90 (t, 1H, $J = 7.6$ Hz), 6.79 (s, 1H, D_2O exchangeable), 3.87 (s, 3H), 3.66 (s, 3H), 1.51 (s, 9H), 1.38 (s, 9H).

^{13}C NMR: δ 185.6, 163.8, 162.3, 142.9, 141.3, 136.1, 132.9, 132.1, 131.2, 130.9, 129.4, 127.9, 127.1, 60.8, 55.9, 52.8, 52.3, 29.9, 28.5.

Mass spectrometric analysis (LRMS-FAB) $[\text{M}+2\text{H}]^+$ calcd for $\text{C}_{24}\text{H}_{30}\text{N}_2\text{O}_6$: 444.59; found: 444.01.

Dimethyl-(2E)-6-benzoyl-3-(cyclohexylamino)-2-(cyclohexylimino)-2H-pyran-4,5-dicarboxylate **122**

To a solution of DMAD **43** (114 mg, 0.80 mmol) and diphenyl triketone **92** (171 mg, 0.67 mmol) in anhydrous CH_2Cl_2 was added cyclohexyl isocyanide **42** (174 mg, 1.60 mmol) and stirred. Processing of the reaction mixture in the usual manner led to the fully substituted pyran **122** as a colourless liquid (182 mg, 55%).

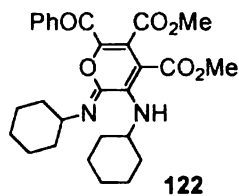

IR (thin film) ν_{\max} : 3350, 2928, 2856, 1722, 1681, 1439, 1352, 1305, 1264, 1202, 1120, 1022 cm^{-1} .

^1H NMR: δ 7.88 (d, 1H, $J = 7.8$ Hz), 7.39 (t, 2H, $J = 7.4$ Hz), 7.14 (t, 2H, $J = 7.6$ Hz), 6.61 (s, 1H, D_2O exchangeable), 3.84 (s, 3H), 3.78 (s, 3H), 3.58 (s, 2H), 3.53 (bs, 2H), 2.38-2.31 (m, 2H), 1.94-1.20 (m, 16H).

^{13}C NMR: δ 186.8, 164.8, 162.6, 141.7, 141.5, 139.7, 138.7, 136.0, 131.1, 130.1, 127.8, 127.2, 126.8, 114.7, 93.1, 92.4, 61.0,

56.7, 52.7, 52.1, 51.4, 50.8, 33.6, 30.4, 28.9, 26.3, 25.6, 25.3, 25.0, 24.6.

Mass spectrometric analysis (LRMS-FAB) Calcd for $C_{28}H_{34}N_2O_6$ $[M+H]^+$: 495.24; found: 495.47.

Dimethyl-(2E)-2-(*tert*-butylamino)-6,8,10-trioxo-1-oxa-7,9-diazaspiro[4.5]dec-3-ene-3,4-dicarboxylate **123**

A solution of DMAD **43** (114 mg, 0.80 mmol) and alloxan hydrate **109** (108 mg, 0.67 mmol) in 10 mL anhydrous CH_2Cl_2 was stirred for 2 minutes. To this solution, *tert*-butyl isocyanide **46** (67 mg, 0.80 mmol) was added *via* a syringe and the reaction mixture was allowed to stir at room temperature for 12 h. On completion of the reaction, solvent was distilled off and the residue was subjected to chromatography on silica gel column using hexanes-ethylacetate solvent mixtures (70:30) to afford the spiro compound **123** as a colourless liquid (82 mg, 33%).

IR (thin film) ν_{max} : 3350, 2989, 2062, 1738, 1665, 1547, 1454, 1434, 1367, 1269, 1218 cm^{-1} .

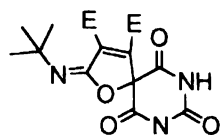

1H NMR: δ 4.86-4.84 (d, 1H, $J = 6.9$ Hz), 3.77 (s, 3H), 3.72 (s, 3H), 3.42-3.39 (d, 1H, $J = 6.9$ Hz), 1.43 (s, 9H).

^{13}C NMR: δ 172.6, 172.5, 169.7, 165.3, 164.8, 135.7, 132.5, 115.6, 110.7, 70.2, 53.1, 52.8, 29.9, 28.7, 28.4.

4.8 References

1. Ugi, I. Ed.; *Isonitrile Chemistry*, Academic Press: New York, 1971.
2. a) Hagedorn, I.; Jonjes, H. *Pharmazie* **1957**, *12*, 567. b) Ando, K.; Tamura, G.; Arima, K. *J. Antibiotics* **1968**, *21*, 587. c) Nobuhara, M.; Tazima, H.; Shudo, K.; Okamoto, T.; Itaka, Y. *Chem. Pharm. Bull.* **1976**, *24*, 832.

3. a) Brockway, L. O. *J. Am. Chem. Soc.* **1936**, *58*, 2516. b) Gordy, W.; Pauling, L. *J. Am. Chem. Soc.* **1942**, *64*, 2952. c) Kessler, M.; Ring, H.; Trambarulo, R.; Gordy, W. *Phys. Rev.* **1950**, *79*, 54.
4. a) Gautier, A. *Liebigs Ann. Chem.* **1867**, *142*, 289. b) Gautier, A. *Liebigs Ann. Chem.* **1869**, *146*, 119.
5. a) Hofmann, A. W. *Hebd. Seances Acad. Sci.* **1867**, *65*, 484. b) Hofmann, A. W. *Liebigs Ann. Chem.* **1867**, *144*, 114.
6. a) Ugi, I.; Fetzer, U.; Eholzer, U.; Knupfer, H.; Offermann, K. *Angew. Chem., Int. Ed. Engl.* **1956**, *4*, 472. b) Skorna, G.; Ugi, I. *Angew. Chem., Int. Ed. Engl.* **1977**, *16*, 259.
7. a) Ugi, I.; Meyr, R. *Chem. Ber.* **1960**, *93*, 239. b) Hertler, W. R.; Corey, E. J. *J. Org. Chem.* **1958**, *23*, 1221. c) Bestmann, H. J.; Lienert, J.; Mott, L. *Ann. Chem.* **1968**, *718*, 24. d) Walborsky, H. M.; Niznik, G. E. *J. Org. Chem.* **1972**, *3*, 187.
8. a) Schöllkopf, U. *Pure Appl. Chem.* **1979**, *51*, 1347. b) Schöllkopf, U.; Hoppe, D.; Jentsch, R. *Chem. Ber.* **1975**, *108*, 1580. c) Schöllkopf, U.; Gerhart, F.; Schroder, R.; Hoppe, D. *Liebigs Ann. Chem.* **1972**, 766.
9. Hoppe, D. *Angew. Chem., Int. Ed. Engl.* **1974**, *13*, 789 and the references cited therein.
10. van Leusen, A. M.; van Leusen, D. in *Encyclopedia of Reagents for Organic Synthesis*; Paquette, L. A. Ed.; John Wiley and Sons: U. K, 1995, *Vol. 7*, p 4973.
11. van Leusen, A. M.; Oogenboom, B. E.; Siderius, T. *Tetrahedron Lett.* **1972**, *13*, 2369.
12. Moskal, J.; van Stralen, R.; Postma, D.; van Leusen, A. M. *Tetrahedron Lett.* **1986**, *27*, 2173.
13. Fukuyama, T.; Chen, X.; Peng, G. *J. Am. Chem. Soc.* **1994**, *116*, 3127.
14. a) Curran, D. P.; Liu, H. *J. Am. Chem. Soc.* **1991**, *113*, 2127. b) Curran, D. P.; Liu, H. *J. Am. Chem. Soc.* **1992**, *114*, 5863.
15. Ito, Y.; Hirao, T.; Saegusa, T. *J. Org. Chem.* **1975**, *40*, 2981.

16. Suzuki, Y.; Takizawa, T. *J. Chem. Soc., Chem. Commun.* **1972**, 873.
17. a) Kabbe, H. J. *Angew. Chem.* **1968**, *80*, 406. b) Middleton, W. J.; England, D. C.; Krespan, C. G. *J. Org. Chem.* **1969**, *34*, 1145. c) Deyrup, J. A.; Vestling, M. M.; Hagan, W. V.; Yun, M. Y. *Tetrahedron* **1969**, *25*, 1467.
18. a) Saegusa, T.; Ito, Y. in *Isonitrile Chemistry*, Ed. Ugi, I. Academic Press, New York, **1971**, p 76. b) Middleton, W. J. *J. Org. Chem.* **1965**, *30*, 1402. c) Avetisyan, E. A.; Gambarayan, N. P. *Izv. Akad. Nauk. SSR Ser. Khim.* **1974**, 1904.
19. a) Burger, K.; Fehn, J.; Muller, E. *Chem. Ber.* **1973**, *1*, 106. b) Gieren, A.; Burger, K.; Thenn, W. Z. *Naturoforsch [b]* **1974**, *29*, 399.
20. a) Burger, K.; Manz, F.; Braun, A. *Synthesis* **1975**, 250. b) Charrier, J.; Person, H.; Foucaud, A. *Tetrahedron Lett.* **1979**, *20*, 1381.
21. Moderhack, D.; Lorke, M. *J. Chem. Soc., Chem. Commun.* **1977**, 831.
22. Knorr, R. *Chem. Ber.* **1956**, *98*, 4038.
23. a) Oakes, T. R.; Donovan, D. J. *J. Org. Chem.* **1973**, *38*, 1319. b) Krebs, A.; Guntner, A.; Versteyleen, S.; Schultz, S. *Tetrahedron Lett.* **1984**, *25*, 2333.
24. Nair, V.; Vinod, A. U. *Chem. Commun.* **2000**, 1019.
25. a) Nair, V.; Vinod, A. U.; Abhilash, N.; Menon, R. S.; Santhi, V.; Varma, L. R.; Viji, S.; Mathew, S.; Srinivas, R. *Tetrahedron* **2003**, *59*, 10279. b) Nair, V.; Menon, R. S.; Ani Deepthi; Remadevi, B.; Biju, A. T. *Tetrahedron Lett.* **2005**, *46*, 1337.
26. Nair, V.; Menon, R. S.; Beneesh, P. B.; Sreekumar, V.; Bindu, S. *Org. Lett.* **2004**, *6*, 767.
27. Mironov, M. A.; Mokrushin, V. S.; Maltsev, S. S. *Synlett* **2003**, 943.
28. Yoshida, H.; Fukushima, H.; Ohshita, J.; Kunai, A. *Angew. Chem., Int. Ed. Engl.* **2004**, *43*, 3935.
29. a) Ito, Y.; Kato, H.; Saegusa, T. *J. Org. Chem.* **1982**, *47*, 741. b) Rigby, J. H.; Qabar, M. N. *J. Am. Chem. Soc.* **1991**, *113*, 8975.

30. a) Nair, V.; Mathew, B.; Vinod, A. U.; Mathen, J. S.; Ros, S.; Menon, R. S.; Varma, L. R.; Srinivas, R. *Synthesis* **2003**, 662. b) Nair, V.; Menon, R. S.; Vinod, A. U.; Viji, S. *Tetrahedron Lett.* **2002**, 43, 2293.
31. de Neufville, R.; von Pechmann, H. *Ber.* **1890**, 23, 3375.
32. For reviews see a) Wasserman, H. H.; Parr, J. *Acc. Chem. Res.* **2004**, 37, 687. b) Rubin, M. B.; Gleiter, R. *Chem. Rev.* **2000**, 100, 1121. c) Rubin, M. B. *Chem. Rev.* **1975**, 75, 177.
33. a) Wolfe, S.; Berry, J. E.; Peterson, M. R. *Can. J. Chem.* **1976**, 54, 210. b) Wasserman, H. H.; Pickett, J. E. *J. Am. Chem. Soc.* **1982**, 104, 4695. c) Schank, K.; Lick, C. *Synthesis* **1983**, 392.
34. a) Mahran, M. R.; Abdou, W. M.; Sidky, M. M.; Wamhoff, H. *Synthesis* **1987**, 506. b) Gleiter, R.; Schang, P. *Angew. Chem.* **1980**, 98, 768. c) Gleiter, R.; Schang, P. *Angew. Chem., Int. Ed. Engl.* **1980**, 19, 715. d) Saba, A. *Synth. Commun.* **1994**, 24, 695.
35. Hoffman, R. V.; Kim, H. -O.; Wilson, A. L. *J. Org. Chem.* **1990**, 55, 2820.
36. Reetz, M. T.; Kyung, S. -H. *Tetrahedron Lett.* **1985**, 26, 6333.
37. Tatsugi, J.; Isawa, Y. *Synth. Commun.* **1998**, 28, 859.
38. Murukami, M.; Masuda, H.; Kawano, T.; Nakamura, H.; Ito, Y. *J. Org. Chem.* **1991**, 56, 1.
39. Hiram, M.; Ito, S. *Tetrahedron Lett.* **1975**, 1071.
40. Gill, G. B.; Idris, M. S. H.; Kirolos, K. S. *J. Chem. Soc.; Perkin Trans. 1* **1992**, 2355.
41. Wasserman, H. H.; Amici, R.; Frechette, R.; van Duzer, J. H. *Tetrahedron Lett.* **1989**, 30, 869.
42. Wasserman, H. H.; Shiraishi, M.; Coats, S. J.; Cook, J. D. *Tetrahedron Lett.* **1995**, 36, 6785.
43. Askin, D.; Reamer, R. A.; Jones, J. K.; Volanti, R. P.; Shinkai, I. *Tetrahedron Lett.* **1989**, 30, 869.

44. Rubin, M. B.; Inbar, S. *Tetrahedron Lett.* **1979**, 5021.
45. Kasai, M.; Oda, M.; Kitahara, Y. *Chem. Lett.* **1978**, 217.
46. Wasserman, H. H.; Blum, C. A. *Tetrahedron Lett.* **1994**, 35, 9787.
47. Batchelor, M. J.; Gillespie, R. J.; Golec, J. M. C.; Hedgecock, C. J. R. *Tetrahedron Lett.* **1993**, 34, 167.
48. Holmgren, A. V.; Wenner, W. *Organic Synthesis Coll. Vol. 4*, 1963, p 23
49. Lipshutz, B. H.; *Chem. Rev.* **1986**, 86, 795.
50. a) Kaey, B. A.; Dibble, P. W. In *Comprehensive Heterocyclic Chemistry II*, Katritzky, A. R.; Rees, C. W.; Scriven, E. F. V.; Eds.; Elsevier: Oxford, **1997**; Vol 2, p 395. b) Donnelly, D. M. X.; Meegan, M. J. In *Comprehensive Heterocyclic Chemistry*, Katritzky, A. R.; Rees, C. W.; Eds.; Pergamon: Oxford, **1984**; Vol.4, p 657.

SUMMARY

The thesis entitled “NOVEL MULTICOMPONENT REACTIONS BASED ON TRIPHENYLPHOSPHINE, DIMETHOXYCARBENE AND ISOCYANIDE – SYNTHESIS OF PHOSPHORANES AND OXYGEN HETEROCYCLES” embodies the results of the investigations carried out to explore the reactivity patterns of the 1:1 zwitterions, generated *in situ* from nucleophilic species (triphenylphosphine, dimethoxycarbene and isocyanide) and dimethyl acetylenedicarboxylate (DMAD) towards activated styrenes and carbonyl compounds.

A general introduction to multicomponent reactions is presented in Chapter 1. A brief introduction to the chemistry of zwitterions and the definition of the present work is also provided in this chapter.

The second chapter describes the addition of the 1:1 zwitterionic intermediate of triphenylphosphine and dimethyl acetylenedicarboxylate to activated styrenes like dicyanostyrenes, cyanoacrylates and β -nitrostyrenes. The addition of the zwitterionic intermediate to 4-methyl benzylidenemalononitrile affording the corresponding cyclopentenyl phosphorane in 63% yield is illustrative (Scheme 1).

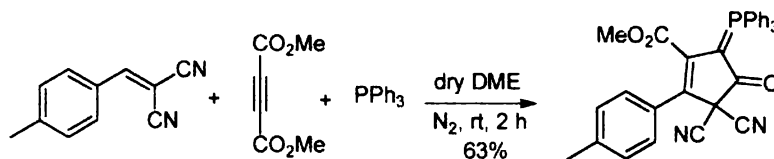

Scheme 1

The addition of the zwitterionic intermediate to β -nitrostyrenes led to the formation of cyclopentadienyl phosphoranes in good yields. The reaction of 3,4-dichloro- β -nitrostyrene with DMAD and triphenylphosphine is illustrative (Scheme 2).

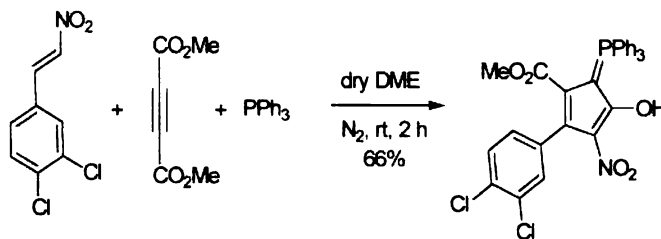

Scheme 2

A successful cleavage of the carbon-phosphorus bond of the ylides was effected using cerium(IV) ammonium nitrate in oxygen atmosphere and a masked diketone was obtained as the product (Scheme 3).

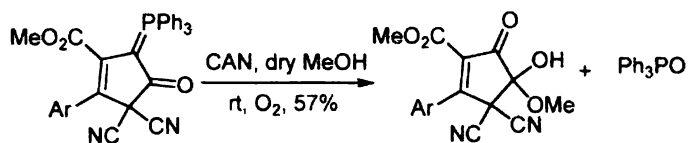

Ar = 4-methylphenyl

Scheme 3

The third chapter describes the reaction of the 1:1 zwitterionic intermediate of dimethoxycarbene generated *in situ* by the thermolysis of 2,2-dimethoxy- Δ^3 -1,3,4-oxadiazoline, and DMAD with 1,2-dicarbonyl compounds. The reaction of benzil with DMAD and oxadiazoline led to the formation of dihydrofuran in 83% yield (Scheme 4).

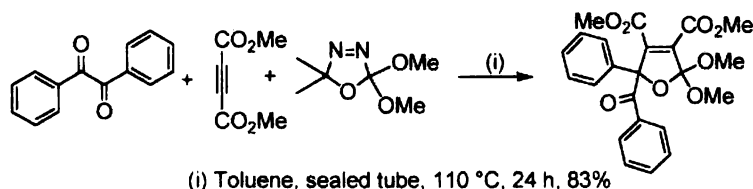

Scheme 4

The reaction of cyclobutene-1,2-dione and N-substituted isatin led to the formation of the corresponding spirodihydrofuran derivative and spirooxindole derivative respectively. The reaction of 3,4-ditolyl cyclobutene dione and N-methyl isatin are illustrative (Scheme 5).

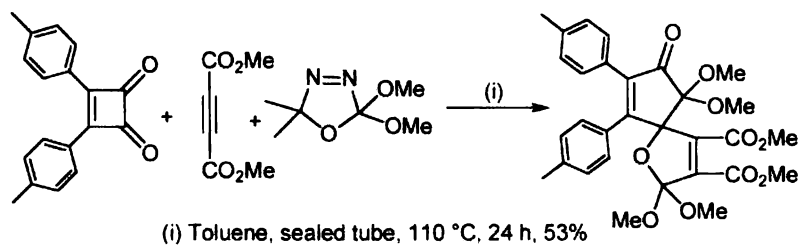

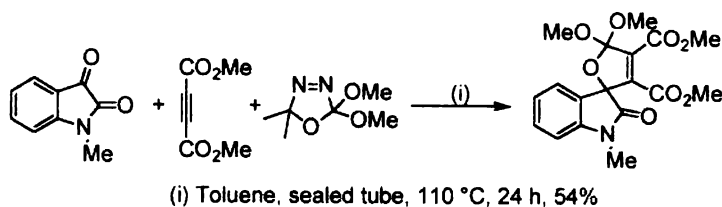
**Scheme 5**

The results of our investigations on the reaction of vicinal tricarbonyl compounds such as diphenyl triketohydrate and diketoester hydrates towards DMAD and isocyanides are presented in Chapter 4. The reaction of diketoethyl ester hydrate, DMAD and *tert*-butyl isocyanide afforded the 2-aminofuran derivative in 56% yield (Scheme 6).

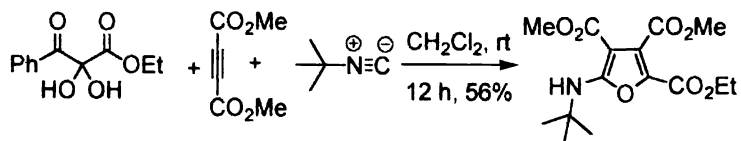
**Scheme 6**

The reaction of diphenyl triketohydrate, DMAD and *tert*-butyl isocyanide afforded the iminopyrone derivative in good yield as illustrated below (Scheme 7).

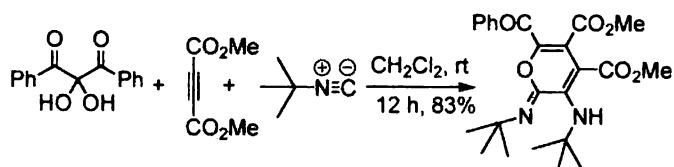
**Scheme 7**

In conclusion, we have discovered novel reactivity patterns of the 1:1 zwitterionic intermediates generated by the addition of nucleophiles to DMAD and thus devised one-pot synthesis of highly functionalized phosphoranes, dihydrofurans, spirodihydrofurans, spirooxindoles and aminofurans. It is interesting to note that spirodihydrofuran and oxindole motifs are present in a number of biologically active natural products and other heterocyclic compounds. It is conceivable that the novel multicomponent reactions described herein will find application in the synthesis of a variety of heterocyclic compounds.

LIST OF PUBLICATIONS

- 1) CAN mediated cyclization of epoxypropyl cinnamyl ethers: A facile stereoselective synthesis of tetrahydropyran derivatives. Nair, V.; Balagopal, L.; Rajan, R.; **Ani Deepthi**; Mohanan, K.; Rath, N. P. *Tetrahedron Lett.* **2003**, *45*, 2413.
- 2) The multicomponent reaction of dimethoxycarbene, dimethyl butynedioate and electrophilic styrenes: An unprecedented synthesis of highly substituted cyclopentenone acetals. Nair, V.; Beneesh, P. B.; Sreekumar, V.; Bindu, S.; Menon, R. S.; **Ani Deepthi** *Tetrahedron Lett.* **2005**, *46*, 201.
- 3) One-pot four-component reaction of isocyanides, dimethyl acetylenedicarboxylate and cyclobutene-1,2-diones: Synthesis of Novel Spiroheterocycles. Nair, V.; Menon, R. S.; **Ani Deepthi**; Rema Devi B.; Biju, A. T. *Tetrahedron Lett.* **2005**, *46*, 1337.
- 4) A novel three component reaction of triphenylphosphine, DMAD and electron deficient styrenes: Facile synthesis of stable cyclopentenyl phosphoranes. Nair, V.; **Ani Deepthi**; Beneesh, P. B. *Synthesis* **2006**, 1443.
- 5) The reaction of dimethoxycarbene-DMAD zwitterion with 1,2-diones and anhydrides: A novel synthesis of highly substituted dihydrofurans and spirodihydrofurans. Nair, V.; **Ani Deepthi**; Manoj, P.; Bindu, S.; Sreekumar, V.; Beneesh, P. B.; Mohan, R. *J. Org. Chem.* **2006**, *71*, 2313.
- 6) A novel reaction of vicinal tricarbonyl compounds with the isocyanide-DMAD zwitterion: Formation of highly substituted furan derivatives. Nair, V.; **Ani Deepthi** *Tetrahedron Lett.* **2006**, *47*, 2037.
- 7) DMAP catalyzed reaction of β -keto esters and dimethyl acetylenedicarboxylate: An efficient synthesis of polysubstituted benzenes and biaryls. Nair, V.; Vidya, N.; Nair, B. T.; **Ani Deepthi**; Nair, A. G.; Suresh, E. (communicated to *Journal of Organic Chemistry*)

T471



POSTERS PRESENTED

1. Nair, V.; **Ani Deepthi**; ManojKumar, P. "Synthesis Of Novel Spiroheterocycles" presented at 7th CRSI National Symposium in Chemistry held at Kolkata, February, 2005, Poster # PP-111.
2. Nair, V.; **Ani Deepthi**; Beneesh, P. B. "Synthesis of Highly Stabilized Phosphoranes *via* the Multicomponent Reaction of TPP, DMAD and Activated Styrenes" presented at International Symposium on Advances in Organic Chemistry, Kottayam, January, 2006, Poster # P- 32
3. Nair, V.; **Ani Deepthi**; Mathew, S. C.; Devipriya, S.; Vidya, N.; Manojkumar, P. "Some Novel Multicomponent Reactions and their Applications in Organic Synthesis" presented at 8th CRSI National Symposium in Chemistry, IIT-Bombay, February, 2006, Poster # PP-149