

**STUDIES ON SOME  
GENERALIZATIONS OF LINE GRAPH  
AND THE POWER DOMINATION  
PROBLEM IN GRAPHS**

Thesis submitted to the  
**Cochin University of Science and Technology**  
for the award of the degree of  
**DOCTOR OF PHILOSOPHY**  
under the **Faculty of Science**

By  
**SEEMA VARGHESE**



Department of Mathematics  
Cochin University of Science and Technology  
Cochin - 682 022

**May 2011**

TO  
*MY PARENTS*

## *Certificate*

This is to certify that the thesis entitled '**Studies on some generalizations of line graph and the power domination problem in graphs**' submitted to the Cochin University of Science and Technology by Ms. Seema Varghese for the award of the degree of Doctor of Philosophy under the Faculty of Science is a bonafide record of studies carried out by her under my supervision in the Department of Mathematics, Cochin University of Science and Technology. This report has not been submitted previously for considering the award of any degree, fellowship or similar titles elsewhere.

Dr. A. Vijayakumar (Supervisor)

Professor and Head

Department of Mathematics

Cochin University of Science and Technology

Cochin- 682022, Kerala.

Cochin-22

31/5/2011.

## *Declaration*

I, Seema Varghese, hereby declare that this thesis entitled '**Studies on some generalizations of line graph and the power domination problem in graphs**' contains no material which had been accepted for any other Degree, Diploma or similar titles in any University or institution and that to the best of my knowledge and belief, it contains no material previously published by any person except where due references are made in the text of the thesis.

Seema Varghese

Research Scholar (Reg. No.2365)

Department of Mathematics

Cochin University of Science and Technology

Cochin-682022, Kerala.

Cochin-22

31/05/2011.

## Acknowledgement

*‘The fear of the LORD is the beginning of wisdom; all who follow his precepts have good understanding’(Psalms 111:10). With this prayer in mind, I bow my head before the God Almighty for his blessings.*

*It is a pleasure to convey my gratitude to all those who made this thesis possible. My humble salutations to all my teachers for being the source of inspiration for this effort.*

*I would like to express the deep most gratitude to my supervisor, Prof.A.Vijayakumar, Professor and Head, Department of Mathematics, Cochin University of Science and Technology for his guidance during my research. His perpetual energy and enthusiasm in research has motivated all students, including me. He has the attitude and the substance of a genius; he continually and convincingly conveyed a spirit of adventure in regard to research, and an excitement in regard to teaching. Without his guidance, persistent help and parental affection this thesis would not have been possible.*

*I thank all the former Heads of the Department of Mathematics, Prof. T. Thrivikraman, Prof. M. Jathavedan, Prof. A. Krishnamoorthy and Prof.R.S.Chakravarti for their support during my research work. I am also grateful to Prof.M.K.Ganapathi, Prof.M.N.Nampoothiri, Prof.B.Lakshmy and Prof.P.G.Romeo for their encouraging words. I also thank the office staff and librarian of the Department of Mathematics for their support and help*

*of various kinds. My gratitude also goes to the authorities of Cochin University of Science and Technology for the facilities they provided. I also thank the University Grants Commission for providing the teacher fellowship during the final years of my research work. I am also grateful to my employer, Director of Collegiate Education, Kerala for sanctioning me deputation to avail the teacher fellowship.*

*I also thank The Principal and Staff of Panampilly Memorial Govt. College, Chalakudy for their support and good wishes. I am also thankful to all my colleagues, especially Prof.Ajithkumar T.A, Prof.Renuka.K, Prof.Murukan Babu, Prof.Albert Antony for their whole hearted support.*

*I express my feeling of gratitude to Dr.Daniela Ferrero, Texas University, USA, who visited CUSAT under the 'ERUDITE' programme of the Government of Kerala, for introducing the notion of power domination and also for permitting to include our joint work in this thesis. I am also thankful to Prof.H.M.Mulder, Erasmus University, The Netherlands for his critical suggestions during my research work.*

*In my daily work I have been blessed with a friendly and cheerful group of fellow researchers. I thank all my Graph Theory friends Dr.B.Radhakrishnan, Dr.K.S. Parvathy, Dr.G.Indulal, Dr. Sunitha M.S, Ms.Savitha K.S, Ms.Pramada Ramachandran, Dr.Aparna Lakshmanan, Dr.Manju.K, Mr.Pravas.K, Mr.Shinoj, Ms.Chithra, Ms.Anu, Mr.Tijo for their advice and willingness to share their bright thoughts with me, which were very fruit-*

*ful for shaping up my ideas and research. I want to express my warmest thanks to my fellow researchers Mr.Varghese Jacob, Mr.Sreenivasan, Ms.Deepthi, Ms.Lalitha, Dr.Pramod, Mr.Tonny, Mr.Didimos, Mr.Jayaprasad, Mr.Kirankumar, Mr.Manikandan, Ms.Anusha, Ms.Reshma and Ms.Vinitha, for their inspiration.*

*I am also extremely thankful to my Parents-in-law, Dr.Jose T.L and Mrs.Kathreena for their support during my research. I wish to express my special thanks to Dr.Jeeja Tharakan and Mr.Prince Joseph for their encouraging words.*

*My deep most gratitude goes to my family for their unflagging love and support throughout my life; this thesis is simply impossible without them. I am greatly indebted to my Parents, Mr.Varghese Kavungal and Mrs.Mercy Varghese, for their care and love towards me. I cannot ask for more from them as they are simply perfect and this thesis is dedicated to them wholeheartedly. I am proud of my sisters, Seena, Seethu and Sahu; thanks for being supportive and caring.*

*I wish to express my deep love and concern to my son Master Abhijith.J.Tharakan who had to sacrifice much during my tough days. I fail to find words to express my appreciation and love to my husband Dr.Jeo Tharakan whose dedication, love and persistent confidence in me, has taken the load off my shoulders. I owe him for being unselfish and let his intelligence, passions and ambitions collide with mine.*

Seema Varghese

**STUDIES ON  
SOME GENERALIZATIONS OF  
LINE GRAPH AND THE POWER  
DOMINATION PROBLEM IN  
GRAPHS**



# Contents

<b>1</b>	<b>Introduction</b>	<b>1</b>
1.1	Basic definitions . . . . .	7
1.2	Basic theorems . . . . .	30
1.3	A survey of previous results . . . . .	31
1.4	Summary of the thesis . . . . .	38
1.5	List of publications . . . . .	43
<b>2</b>	<b><i>H</i>-line graphs</b>	<b>45</b>
2.1	Non-existence of forbidden subgraph characteri- zation . . . . .	46

---

2.2	Krausz-type characterization for star-line graphs . . . . .	50
2.3	3-star-line-index of a graph . . . . .	52
2.4	4-star-line-index of a graph . . . . .	61
2.5	n-star-line-index of a graph . . . . .	63
<b>3</b>	<b>Cycle graphs</b>	<b>65</b>
3.1	Cycle graph of outerplanar graphs . . . . .	66
3.2	The girth of a cycle graph . . . . .	71
3.3	Chordal cycle graphs . . . . .	75
3.4	Domination number, radius and diameter . . . . .	77
3.5	Solution of a graph equation . . . . .	85
<b>4</b>	<b>Power domination in grid graphs</b>	<b>87</b>
4.1	Hexagonal grids . . . . .	88
4.2	Triangular grids . . . . .	94

<b>5 Power domination in some classes of graphs</b>	<b>99</b>
5.1 Mycielskian of graphs . . . . .	100
5.2 Generalized Mycielskian of paths . . . . .	107
5.3 The direct product . . . . .	110
5.4 The Cartesian product . . . . .	117
<b>Conclusion</b>	<b>123</b>
<b>List of symbols</b>	<b>125</b>
<b>Bibliography</b>	<b>129</b>
<b>Index</b>	<b>139</b>

# Chapter 1

## Introduction

Graph theory is rooted in the eighteenth century, beginning with the work of Euler, who is known as the father of graph theory. The origin of graph theory can be traced back to Euler's work on the Königsberg bridges problem. The problem was to find a closed walk that crosses each of the seven bridges of Königsberg exactly once. Leonard Euler gave a negative solution to this problem in 1736 by using parity arguments that are essentially graph theoretical; however the familiar graph that models the problem (with four vertices for the land areas and seven edges for bridges) did not appear till 1892. This led to the discov-

ery of Eulerian graphs. The study of cycles on polyhedra by the Thomas P. Kirkman (1806 - 95) and William R. Hamilton (1805-65) led to the concept of a Hamiltonian graph. The concept of a tree, a connected graph without cycles, appeared implicitly in the work of Gustav Kirchhoff (1824-87), who employed graph-theoretical ideas in the calculation of currents in electrical networks or circuits. Later, Arthur Cayley (1821-95), James J. Sylvester(1806-97), George Polya(1887-1985), and others used ‘tree’ to enumerate chemical molecules.

The origin and development of graph theory is well recorded in [14]. Graph theory is rapidly moving into the mainstream of mathematics mainly because of its applications in diverse fields which include biochemistry (genomics), electrical engineering (communications networks and coding theory), computer science (algorithms and computations) and operations research (scheduling). The powerful combinatorial methods found in graph theory have also been used to prove significant and well-known results in a variety of areas in mathematics itself. Volumes have been written on the rich theory and the very many applications of graphs such as [24], [34], [40], [41], [58] and [68].

---

In the past decade, graph theory has gone through a remarkable shift and a profound transformation. The change is in large part due to the humongous amount of information that we are confronted with. A main way to sort through massive data sets is to build and examine the network formed by interrelations. For example, Google's successful web search algorithms are based on the WWW graph [10], which contains all web pages as vertices and hyperlinks as edges. Web graphs are examples of large, dynamic, distributed graphs and shares many properties with several other complex graphs [57] found in a variety of systems ranging from social organizations to biological systems. The 'PageRank' [16] is an exciting notion related to web graphs. Of particular interest to mathematicians is the collaboration graph, which is based on the data from Mathematical Reviews.

This thesis is a humble effort to enrich this powerful branch by investigating some graph classes which arise as generalizations of the line graph. We also attempt to study the concept of power domination in certain classes of graphs.

When dealing with special graph classes, a main source is the classical book by Golombic [35]. Since then many interesting new graph classes have been studied as discussed in detail by Brandstädt et al. [15]. The introduction of the concept of graph operators boosted the study of graph classes. In fact, the intersection graphs form a sub-collection of the graph classes obtained by using graph operators. The intersection graph is a very general notion in which objects are assigned to the vertices of a graph and two distinct vertices are adjacent if the corresponding objects have a non empty intersection. A variety of well studied graph classes such as the line graphs, the clique graphs and the block graphs are special types of intersection graphs.

‘Graph operator’ is a mapping from a set of graphs  $\mathcal{G}$  into itself. Krausz [46] introduced the concept of the line graph and thus that of ‘graph operators’. The study of graph operators gained increasing importance due to the study of its dynamics as detailed by Prisner [59]. It is quiet interesting to study the relationship between the parameters of  $G$  and those of graph operators. It is also interesting to study what happens when

these graph operators act on some special graph classes. The notion of  $P_3$ -intersection graph and its dynamics are studied in [54] and [55].

A large part of graph theory involves the computation of graphical invariants. The reason is that many applications in different fields reduce to such computations. The computation of at least some of the invariants are proved to be NP-complete in general. Thus, even the computation of such invariants in particular classes of graphs are interesting. The domination problem is one such. It turns out that a variety of optimization problems are graph domination problems in disguise. The concept of ‘domination’ has attracted interest among many graph theorists due to its wide applications in many real world situations. The historical conception and the subsequent development of this fertile area of domination theory from the chessboard problems is very well surveyed by Watkins in [67]. This concept is gaining importance and a good number of research papers and books are being written in this area [13], [23], [58], [70].



A lot many variations of the concept of domination is studied recently. The ‘power domination’ problem is one such. A power network contains a set of nodes and a set of edges connecting the nodes. It also contains a set of generators, which supply power, and a set of loads, where the power is directed to. In order to monitor a power network we need to measure all the state variables of the network by placing measurement devices. A Phase Measurement Unit (PMU) is a measurement device placed on a node that has the ability to measure the voltage of the node and current phase of the edges connected to the node and to give warnings of system-wide failures. The goal is to install the minimum number of PMUs such that the whole system is monitored. This problem was modeled using the concepts of graph theory by Haynes et al. in [37] and then it turned out to be a variant of the famous problem of dominating sets in graphs.

To see the power domination problem and its graph theoretic formulation [1] in more detail consider a power network  $G = (V, E)$ . The resistance of the edges in the power network is a property of the material with which it is made and hence it can be assumed to be known. Our goal is to measure the

voltages at all nodes and electrical currents at the edges. By placing a PMU at a node  $v$  we can measure the voltage of  $v$  and the electrical current on each edge incident to  $v$ . Next, by using Ohm's law we can compute the voltage of any node in the neighbourhood of  $v$ . Now, assume that the voltage  $v$  and all of its neighbours except  $w$  is known. By applying Ohm's law we can compute the current on the edges incident to  $v$  except the edge  $vw$ . Next by using Kirchoff's law we compute the current on the edge  $vw$ . Finally, applying Ohm's law on the edge  $vw$  gives us the voltage of  $w$ .

## 1.1 Basic definitions

The basic notations, terminology and definitions are from [9], [18], [35], [36] and [68] and the basic results are from [38], [42] and [59].

**Definition 1.1.1.** A **graph**  $G = (V, E)$  consists of a collection of points,  $V$  called its **vertices** and a set of unordered pairs of distinct vertices,  $E$  called its **edges**. If  $|V|$  is finite, then  $G$  is a **finite graph**. The unordered pair of vertices  $\{u, v\} \in E$

are called the **end vertices** of the edge  $e = uv$ . When  $u$  and  $v$  are end vertices of an edge, then  $u$  and  $v$  are **adjacent**. If the vertex  $v$  is an end vertex of an edge  $e$ , then  $e$  is **incident** to  $v$ . Two edges which are incident with a common vertex are said to be **adjacent edges**. The cardinality of  $V$  is called the **order** of  $G$  and the cardinality of  $E$  is called the **size** of  $G$ . A graph is the **null graph**, denoted by  $\phi$  if it has no vertices and **trivial graph** if it has no edges.

**Definition 1.1.2.** The **degree** of a vertex  $v$ , denoted by  $\deg(v)$  is the number of edges incident to  $v$ . A graph  $G$  is  **$k$ -regular** if  $\deg(v) = k$  for every vertex  $v \in V$ . A vertex of degree zero is an **isolated vertex** and of degree one is a **pendant vertex**. The edge incident on a pendant vertex is a **pendant edge**. A vertex of degree  $n - 1$  is called a **universal vertex**. In a graph  $G$ , the maximum degree of vertices is denoted by  $\Delta(G)$  and the minimum degree of vertices is denoted by  $\delta(G)$ .

**Definition 1.1.3.** A graph  $G = (V, E)$  is **isomorphic** to a graph  $H = (V', E')$  if there exists a bijection from  $V$  to  $V'$  which preserves adjacency. If  $G$  is isomorphic to  $H$ , we write  $G \cong H$ .

**Definition 1.1.4.** A graph  $H = (V', E')$  is called a **subgraph** of  $G$  if  $V' \subseteq V$  and  $E' \subseteq E$ . A subgraph  $H$  is a **spanning subgraph** if  $V' = V$ . The graph  $H$  is called an **induced subgraph** of  $G$  if  $E'$  is the collection of all edges in  $G$  which has both its end vertices in  $V'$ .  $\langle V' \rangle$  denotes the induced subgraph with vertex set  $V'$ . A graph  $G$  is  **$H$ -free** if it does not contain  $H$  as an induced subgraph.

**Definition 1.1.5.** Given a nonempty class  $\mathcal{C}$  of graphs, a graph  $G$  is said to be  **$\mathcal{C}$ -free**, if none of the induced subgraphs of  $G$  belong to  $\mathcal{C}$ . Let  $\mathcal{G}(\mathcal{C})$  denote the class of graphs which are  **$\mathcal{C}$ -free**. If  $\mathcal{H}$  is a class of graphs, we say that  $F$  is a **forbidden subgraph for  $\mathcal{H}$**  if no element of  $\mathcal{H}$  has  $F$  as an induced subgraph. If  $\mathcal{H} = \mathcal{G}(\mathcal{C})$ , for some class  $\mathcal{C}$  of graphs, we say that  $\mathcal{H}$  has a **forbidden subgraph characterization**. A class  $\mathcal{C}$  of graphs has the **induced hereditary property** if  $G \in \mathcal{C}$  implies that every induced subgraph of  $G$  also belongs to  $\mathcal{C}$ .

**Definition 1.1.6.** A  $v_0$ - $v_k$  **walk** in a graph  $G$  is a finite list  $v_0, e_1, v_1, e_2, v_2, \dots, e_k, v_k$  of vertices and edges such that for  $1 \leq i \leq k$ , the edge  $e_i$  has end vertices  $v_{i-1}$  and  $v_i$ . In the  $v_0$ - $v_k$  walk,  $v_0$  is the **origin**,  $v_k$  is the **terminus** and  $v_1, v_2, \dots, v_{k-1}$  are

its **internal vertices** . If the vertices  $v_0, v_1, \dots, v_k$  of the above walk are distinct, then it is called a **path**. A path from a vertex  $u$  to a vertex  $v$  is called a  $u-v$  **path**. A path on  $n$  vertices is denoted by  $P_n$ . If the edges  $e_1, e_2, \dots, e_k$  of the walk are distinct, it is called a **trail**. A graph  $G$  is **Eulerian** if it has a closed trail containing all the edges. A nontrivial closed trail is called a **cycle** if its origin and internal vertices are distinct. A cycle with  $n$  vertices is denoted by  $C_n$ . The **length** of a walk, a path or a cycle is its number of edges. A graph containing exactly one cycle is called a **unicyclic graph**. A graph is **acyclic** if it does not contain cycles. The **girth** of  $G$ ,  $g(G)$  is the length of a shortest cycle in  $G$ . An acyclic graph has infinite girth. The **circumference** of  $G$ ,  $c(G)$  is the length of any longest cycle in  $G$ . A graph is **hamiltonian** if it has a spanning cycle.

**Definition 1.1.7.** A graph  $G$  is **connected** if for every  $u, v \in V$ , there exists a  $u-v$  path. If  $G$  is not connected then it is **disconnected**. The **components** of  $G$  are its maximal connected subgraphs. A connected acyclic graph is called a **tree**. A **caterpillar** is a tree in which a single path (called the **spine**) is incident to every edge.

**Definition 1.1.8.** The **distance** between two vertices  $u$  and  $v$  of a connected graph  $G$ , denoted by  $d(u, v)$  or  $d_G(u, v)$  is the length of a shortest  $u-v$  path in  $G$ . The **eccentricity** of a vertex  $u$ ,  $e(u) = \max\{d(u, v) | v \in V(G)\}$ . The **radius**  $r(G)$  and the **diameter**  $d(G)$  are respectively the minimum and the maximum of the vertex eccentricities.

**Definition 1.1.9.** A **chord** of a cycle  $C$  is an edge not in  $C$  whose end points lie in  $C$ . A graph  $G$  is **chordal** if every cycle of length at least four in  $G$  has a chord.

**Definition 1.1.10.** A **complete graph** is a graph in which each pair of distinct vertices is joined by an edge and is denoted by  $K_n$ . The graph obtained by deleting any edge of  $K_n$  is denoted by  $K_n - \{e\}$ .  $K_3$  is called a **triangle** and a **paw** is a triangle with a pendant edge. A **clique** is a maximal complete subgraph.

**Definition 1.1.11.** The set of all vertices adjacent to a vertex  $v$  is called **open neighborhood** of  $v$ , denoted by  $N(v)$ . The **closed neighborhood** of  $v$ ,  $N[v] = N(v) \cup \{v\}$ . For a subset  $S$  of  $V(G)$ , the **open neighborhood of  $S$** ,  $N(S) = \cup_{v \in S} N(v) - S$ . The **closed neighborhood of  $S$** ,  $N[S]$  of a subset  $S$  is the set

$$N[S] = N(S) \cup S.$$

**Definition 1.1.12.** Let  $G$  be a graph. The **complement** of  $G$ , denoted by  $G^c$  is the graph with vertex set same as that of  $V$  and any two vertices are adjacent in  $G^c$  if they are not adjacent in  $G$ .  $K_n^c$  is called **totally disconnected**. A graph  $G$  is **self complementary** if  $G \cong G^c$ .

**Definition 1.1.13.** A graph  $G$  is **bipartite** if the vertex set can be partitioned into two non-empty sets  $U$  and  $U'$  such that every edge of  $G$  has one end vertex in  $U$  and the other in  $U'$ . A bipartite graph in which each vertex of  $U$  is adjacent to every vertex of  $U'$  is called a **complete bipartite graph**. If  $|U| = m$  and  $|U'| = n$ , then the complete bipartite graph is denoted by  $K_{m,n}$ . The complete bipartite graph  $K_{1,n}$  is called a  **$n$ -star**. The graph  $K_{1,3}$  is called a **claw**.

**Definition 1.1.14.** For a graph  $G$ , a subset  $V'$  of  $V(G)$  is a  **$k$ -vertex cut** of  $G$  if the number of components in  $G - V'$  is greater than that of  $G$  and  $|V'| = k$ . The **vertex connectivity** of  $G$ ,  $\kappa(G)$  is the smallest number of vertices in  $G$  whose deletion from  $G$  increases the number of components of  $G$ . A graph is  **$n$ -connected** if  $\kappa(G) \geq n$ . A vertex  $v$  of  $G$  is a **cut vertex** of

$G$  if  $\{v\}$  is a vertex cut of  $G$ . If  $G$  has no cut vertices, then  $G$  is a **block**. The **edge connectivity** of a graph  $G$ ,  $\kappa'(G)$  is the least number of edges whose deletion increases the number of components of  $G$  or results a  $K_1$ .

**Definition 1.1.15.** A graph is **planar** if there exists a drawing of  $G$  in the plane in which no two edges intersect in a point other than a vertex of  $G$ , where each edge is a simple arc or a Jordan arc. Such a drawing is a **planar embedding** of  $G$ . A **plane graph** is a particular drawing of a planar graph in the plane with no crossings.

**Definition 1.1.16.** Let  $G$  be a plane graph and  $\pi$  be the plane minus the edges and vertices of  $G$ . We say that for points  $A$  and  $B$  of  $\pi$ ,  $A \equiv B$  if and only if, there exists a Jordan arc from  $A$  to  $B$  in  $\pi$ . The equivalence classes of the above equivalence relation are called **faces** of  $G$ .

**Definition 1.1.17.** A graph is an **outerplanar** if it has an embedding in the plane such that every vertex lies in the unbounded face. An **outerplane graph** is a planar embedding with every vertex on the unbounded face. A **maximal outerplanar graph** is an outer planar graph that is not a spanning



subgraph of any other outerplanar graph.

**Definition 1.1.18.** A subset  $I \subseteq V$  of vertices is **independent** if no two vertices of  $I$  are adjacent. The maximum cardinality of an independent set is called the **independence number** and is denoted by  $\alpha(G)$ . A subset  $F \subseteq E$  of edges is said to be an **independent set of edges** or a **matching** if no two edges in  $F$  have a vertex in common. The maximum cardinality of a matching set of edges is the **matching number** or **edge-independence number** and is denoted by  $\alpha'(G)$ .

**Definition 1.1.19.** A subset  $S \subseteq V$  of vertices is a **dominating set** if each vertex of  $G$  that is not in  $S$  is adjacent to at least one vertex of  $S$ . If  $S$  is a dominating set then  $N[S] = V$ . A dominating set of minimum cardinality in  $G$  is called a minimum dominating set, and its cardinality, the **domination number** of  $G$ , denoted by  $\gamma(G)$ .

**Definition 1.1.20.** A **subdivision of an edge**  $e = uv$  of a graph  $G$  is obtained by introducing a new vertex  $w$  in  $e$ , that is, by replacing the edge  $e = uv$  of  $G$  by the path  $uwv$  of length two so that the new vertex  $w$  is of degree two in the resulting graph. A **homeomorph** or a **subdivision of a graph**  $G$  is a graph

obtained from  $G$  by applying a finite number of subdivisions of edges in succession.  $G$  itself is regarded as a subdivision of  $G$ . Two graphs  $G$  and  $H$  are called **homeomorphic** if they are both homeomorphs of the same graph. The graph obtained from  $G$  by subdividing each edge of  $G$  exactly once is called the **subdivision of  $G$**  and is denoted by  $S(G)$ .

**Definition 1.1.21.** If  $e = uv$  is an edge of  $G$ , then the **contraction** of  $e$  is the operation of replacing  $u$  and  $v$  by a single vertex whose incident edges are the edges other than  $e$  that were incident to  $u$  or  $v$ . A graph  $G$  is **contractible** to a graph  $H$  or  $H$  is a **contraction** of  $G$ , if  $H$  can be obtained from  $G$  by a sequence of edge contractions.

**Definition 1.1.22.** The **join** of two graphs  $G$  and  $H$ , denoted by  $G \vee H$ , is the graph with vertex set  $V(G) \cup V(H)$  and the edge set  $E(G) \cup E(H) \cup \{gh \mid g \in V(G), h \in V(H)\}$ . The graph  $K_1 \vee C_{n-1}$  is called the **wheel**,  $W_n$ . The graph  $K_1 \vee P_{n-1}$  is called the **fan**,  $F_n$ .

**Definition 1.1.23.** Let  $G_1$  and  $G_2$  be two graphs of order  $n_1$  and  $n_2$  respectively. The **corona** of  $G_1$  and  $G_2$ , denoted by  $G_1 \circ G_2$ , is the graph obtained by taking one copy of  $G_1$  and

$n_1$  copies of  $G_2$ , and then joining the  $i^{\text{th}}$  vertex of  $G_1$  to every vertex in the  $i^{\text{th}}$  copy of  $G_2$ .

**Illustration:**

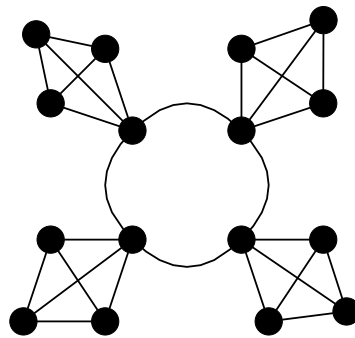

Fig 1.1:  $C_4 \circ K_3$

**Definition 1.1.24.** The **Cartesian product** of two graphs  $G$  and  $H$ , denoted by  $G \square H$ , is the graph with vertex set  $V(G) \times V(H)$ . Two vertices  $(g, h)$  and  $(g', h')$  are adjacent in  $G \square H$  if they are equal in one coordinate and adjacent in the other. The graph  $P_n \square P_m$  is called the  $n \times m$  **grid graph**. The graph  $P_n \times C_m$  is called a **cylinder** and the graph  $C_n \times C_m$  is called a **torus**.

**Illustration:**

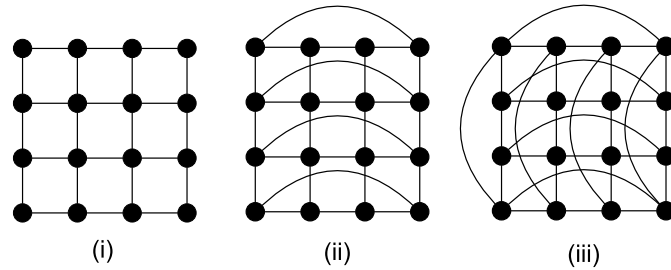

Fig 1.2: (i)  $4 \times 4$ -grid (ii)  $4 \times 4$ -cylinder (iii)  $4 \times 4$ -torus

**Definition 1.1.25.** The **direct product** of two graphs  $G$  and  $H$ , denoted by  $G \times H$ , is the graph with vertex set  $V(G) \times V(H)$ . Two vertices  $(g, h)$  and  $(g', h')$  are adjacent in  $G \times H$  if they are adjacent in both coordinates.

**Definition 1.1.26.** Let  $G * H$  be any of the graph products. For any vertex  $g \in G$ , the subgraph of  $G * H$  induced by  $\{g\} \times V(H)$  is called the  **$H$ -fiber** at  $g$  and denoted by  ${}^gH$ . For any vertex  $h \in H$ , the subgraph of  $G * H$  induced by  $V(G) \times \{h\}$  is called the  **$G$ -fiber** at  $h$  and denoted by  $G^h$ .

**Definition 1.1.27.** The **intersection graph** of a collection of objects is the graph whose vertex set is that collection and any two vertices are adjacent if the corresponding objects

intersect. The intersection graph of all the edges of  $G$  is the **line graph** of  $G$  denoted by  $L(G)$ . Thus, the line graph  $L(G)$  of a graph  $G$  has as its vertices the edges of  $G$  and two vertices of  $L(G)$  are adjacent if the corresponding edges of  $G$  are adjacent.

**Illustration:**

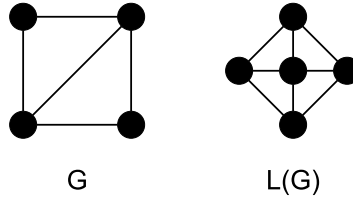

Fig 1.3:  $G$  and  $L(G)$

**Definition 1.1.28.** For any graph  $G$ , the  $n^{\text{th}}$  **iterated graph** under the operator  $\Phi$  is iteratively defined as  $\Phi^1(G) = \Phi(G)$  and  $\Phi^n(G) = \Phi(\Phi^{n-1}(G))$  for  $n > 1$ . A graph  $G$  is  $\Phi^n$ -complete if  $\Phi^n(G)$  is a complete graph. If there is some integer  $N$  such that  $\Phi^{n+1}(G) = \Phi^n(G)$  whenever  $n \geq N$ , then the sequence  $\{\Phi^k(G)\}$  is said to  **$\Phi$ -converge**, and  $\Phi^N(G)$  is called the **limit  $\Phi$  graph**. If  $G$  is not convergent under  $\Phi$ , then  $G$  is  **$\Phi$ -divergent**. A graph  $G$  is  **$\Phi$ -periodic** if there is some natural number  $n$  with

$G = \Phi^n(G)$ . The smallest such number  $n$  is called the **period** of  $G$ . A graph  $G$  is  **$\Phi$ -fixed** if the period of  $G$  is one.

**Illustration:**

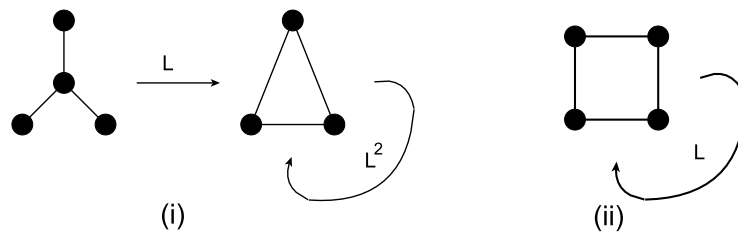

Fig 1.4: (i)  $K_{1,3}$  is  $L$ -convergent (ii)  $C_4$  is  $L$ -fixed

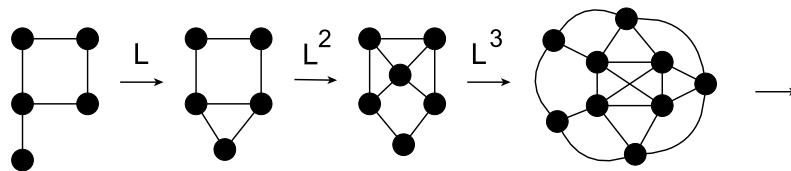

Fig 1.5: An example of  $L$ -divergent graph

**Definition 1.1.29.** [43] The **triangular line graph** , has as its vertices the edges of  $G$  and two vertices are adjacent if the corresponding edges belong to a common triangle of  $G$ . It

is also known as **anti-Gallai graph**.

**Illustration:**

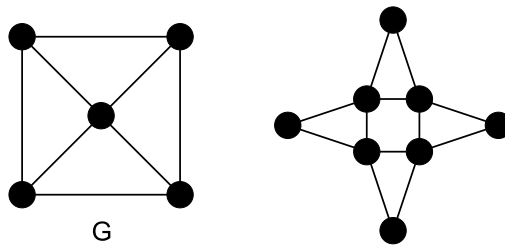

Fig 1.6:  $G$  and its triangular line graph

**Definition 1.1.30.** [20] Let  $H$  be a connected graph of order  $n \geq 3$ . The  $H$ -**line graph** of  $G$ , denoted by  $L_H(G)$ , is the graph with the edges of  $G$  as its vertices. Two vertices of  $L_H(G)$  are adjacent if the corresponding edges in  $G$  are adjacent and lie in a common copy of  $H$ . A graph  $G$  is an  $H$ -**line graph** if there exists a graph  $G'$  such that  $G \cong L_H(G')$ . If  $H \cong K_{1,n}$ ,  $n \geq 3$ ,  $H$ -line graphs are called  $n$ -**star-line graphs**.

Illustration:

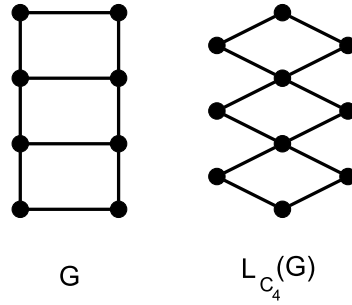

Fig 1.7:  $G$  and  $L_{C_4}(G)$

**Definition 1.1.31.** The  $n$ -star-line index of a graph  $G$ ,  $\zeta_n(G)$ , is the smallest  $k$  such that  $L_{K_{1,n}}^k(G)$  is nonplanar. If  $L_{K_{1,n}}^k(G)$  is planar for all  $k \geq 0$ , we define  $\zeta_n(G) = \infty$ .

Illustration:

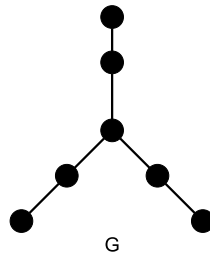
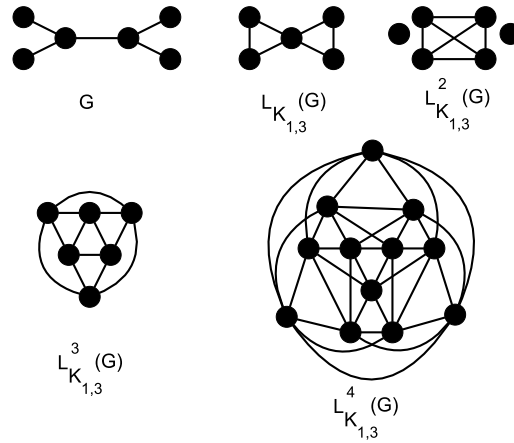

Fig 1.8:  $\zeta_3(G) = \infty$



Fig 1.9:  $\zeta_3(G) = 4$ 

**Definition 1.1.32.** [7] The **triangle graph**,  $T(G)$  of a graph  $G$  has as its vertices the triangles of  $G$  and two vertices of  $T(G)$  are adjacent if the corresponding triangles in  $G$  have a common edge. If  $G$  is triangle-free, then  $T(G)$  is the null graph. A graph  $G$  is a **triangle graph**, if there exists a graph  $H$  such that  $T(H) \cong G$ .  $H$  is called an **inverse triangle graph** of  $G$ .

**Illustration:**

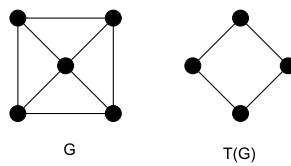
Fig 1.10:  $G$  and  $T(G)$

**Definition 1.1.33.** [31] The **cycle graph**,  $Cy(G)$  of a graph  $G$ , has as its vertices the induced cycles of  $G$  and two vertices of  $Cy(G)$  are adjacent if the corresponding induced cycles have a common edge. If  $G$  is acyclic, then  $Cy(G)$  is the null graph. A graph  $G$  is a **cycle graph**, if there exists a graph  $H$  such that  $Cy(H) \cong G$ .  $H$  is called an **inverse cycle graph** of  $G$ . The  **$n$ -th iterated cycle graph** of  $G$  is defined recursively by  $Cy^n(G) = Cy(Cy^{n-1}(G))$  for  $n \geq 2$ . A graph is said to be **cycle-vanishing** if there exists a nonnegative integer  $n$  such that  $Cy^n(G)$  is the null graph. Otherwise  $G$  is said to be **cycle-persistent**.

**Illustration:**

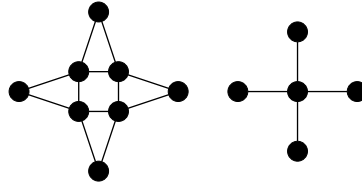

Fig 1.11:  $G$  and  $Cy(G)$

**Definition 1.1.34.** [26] Let the graph  $G = (V, E)$  represent an electric power system, where a vertex represents an electrical node and an edge represents a transmission line joining two

electrical nodes. For a subset  $S \subseteq V(G)$ , the set **monitored** by  $S$ ,  $M(S)$  is defined recursively as follows:

1. *Domination step*:  $M(S) \leftarrow S \cup N(S)$

2. *Propagation step*: As long as there exists  $v \in M(S)$  such that  $N(v) \cap (V(G) - M(S)) = \{w\}$  set  $M(S) \leftarrow M(S) \cup \{w\}$ .

In other words, first put into  $M(S)$  the vertices from the closed neighborhood of  $S$ . Then, repeatedly add to  $M(S)$  vertices  $w$  that have a neighbor  $v$  in  $M(S)$  such that all other neighbors of  $v$  are already in  $M(S)$ . If no such vertex  $w$  exists, the set monitored by  $S$  has been constructed.

**Illustration:**

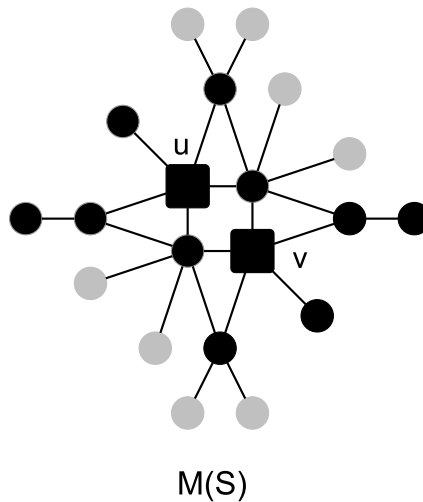

Fig 1.12:  $M(S)$  where  $S = \{u, v\}$

**Definition 1.1.35.** A set  $S$  is called a **power dominating set** of  $G$  if  $M(S) = V(G)$  and the **power domination number** of  $G$ ,  $\gamma_p(G)$ , is the minimum cardinality of a power dominating set of  $G$ .

**Illustration:**

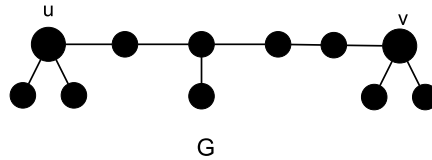

Fig 1.13:  $S = \{u, v\}$  is a power dominating set.  $\gamma_p(G) = 2$  and  $\gamma(G) = 3$ .

**Definition 1.1.36.** [65] For given positive integers  $m, n$  such that  $m < n$ ,  $[m, n] = \{m, m+1, \dots, n-1, n\}$ . The **hexagonal honeycomb grid** of dimension  $n \geq 1$ ,  $n \in \mathbf{Z}$ ,  $HM_n$ , has vertex set  $V(HM_n) = \{(x, y, z) \mid x, y, z \in [-n+1, n] \text{ and } 1 \leq x+y+z \leq 2\}$  and two vertices  $(x_1, y_1, z_1)$  and  $(x_2, y_2, z_2)$  are adjacent if and only if  $|x_1 - x_2| + |y_1 - y_2| + |z_1 - z_2| = 1$ . For every  $k \in [-n+1, n]$ , the  **$X$ -diagonal** at  $k$  is denoted by  $X_k$  and is defined as  $X_k = \{(k, y, z) \in HM_n \mid 1 - k \leq y + z \leq 2 - k\}$ . A vertex  $v$  is said to **cover a diagonal**  $X$ , if  $v \in X$ . A set  $T \subseteq V(G)$  is said to cover a diagonal  $X$ , if there exists an ele-

ment  $t \in T$  which covers  $X$ .

**Note:** The  $Y$ -diagonals and  $Z$ -diagonals are defined similarly.

**Illustration:**

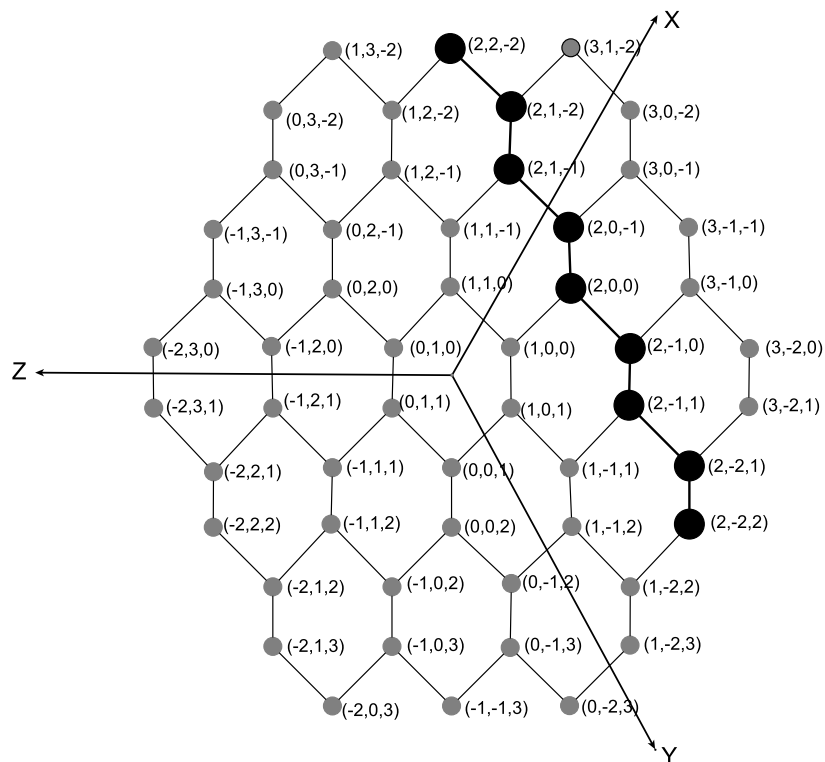

Fig 1.14:  $X_2$  in  $HM_3$

**Definition 1.1.37.** [2] For any integer  $n$ , the **triangular grid**,  $T_n$ , is the graph whose vertices are ordered triples

$(i, j, k)$  of nonnegative integers summing to  $n$ , and two vertices are joined by an edge if they agree in one co-ordinate and differ by one in the other two. For each integer  $c \in [0, n]$ ,  $I_c$ , the  **$I$ -diagonal** at  $c$  is defined as the subgraph induced by the vertices whose  $i$ -coordinate equals  $c$ . A diagonal at zero is called a **boundary** of  $T_n$ . A vertex  $v$  **covers a diagonal** if it belongs to that diagonal.

**Note:** The diagonals  $J_c$  and  $K_c$  are defined similarly.

**Illustration:**

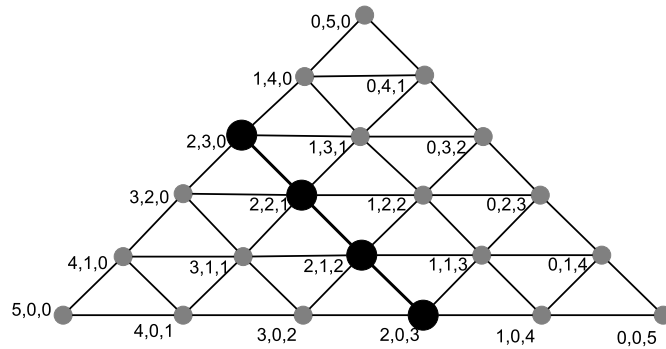

Fig 1.15:  $I_2$  in  $T_5$

**Definition 1.1.38.** Let  $m$  and  $n$  be integers such that  $m < n$ . A  $m \times n$  **rectangular triangular grid**,  $RT_{m,n}$ , has the vertex set,  $V(RT_{m,n}) = \{(i, j, k) : i \in [-n, m], j \in [0, m], k \in$

$[0, n]$  and  $|i + j + k| = n$ , with an edge connecting two triples if they agree in one co-ordinate and differ by one in the other two.

**Illustration:**

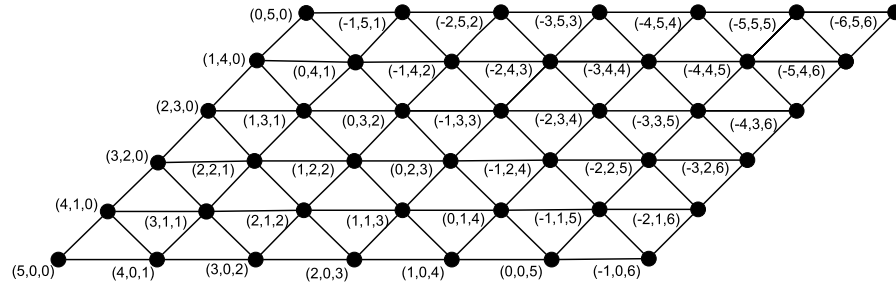

Fig 1.16:  $RT_{5,6}$

**Definition 1.1.39.** [56] For a graph  $G = (V, E)$ , the **Mycielskian** of  $G$ ,  $\mu(G)$  is the graph with vertex set  $V \cup V' \cup z$ , where  $V' = \{u' : u \in V\}$ , and edge set  $E \cup \{uv' : uv \in E\} \cup \{v'z : v' \in V'\}$ . The vertex  $u'$  is called the **twin** of the vertex  $u$  (and  $u$  the twin of  $u'$ ) and the vertex  $z$  is called the **root** of  $\mu(G)$ .

**Illustration:**

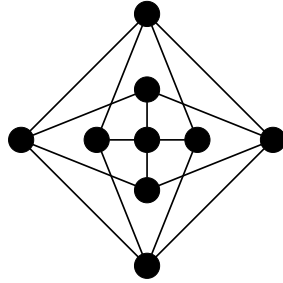

Fig 1.17:  $\mu(C_4)$

**Definition 1.1.40.** [52] Let  $G$  be a graph with vertex set  $V^0 = \{v_1^0, v_2^0, \dots, v_n^0\}$  and edge set  $E^0$ . Given an integer  $m \geq 1$  the **generalized  $m$ -Mycielskian** of  $G$  denoted by  $\mu_m(G)$ , is the graph with vertex set  $V^0 \cup V^1 \cup V^2 \cup \dots \cup V^m \cup \{z\}$ , where  $V^i = \{v_j^i : v_j^0 \in V^0\}$  is the  $i$ th distinct copy of  $V^0$  for  $i = 1, 2, \dots, m$  and edge set  $E^0 \cup (\cup_{i=0}^{m-1} \{v_j^i v_{j'}^{i+1} : v_j^0 v_{j'}^0 \in E^0\}) \cup \{v_j^m z : v_j^m \in V^m\}$ .

**Illustration:**

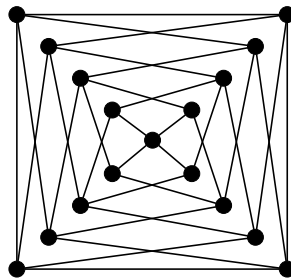

Fig 1.18:  $\mu_3(C_4)$



## 1.2 Basic theorems

**Theorem 1.2.1.** [33] *A class of graphs  $\mathcal{C}$  has a forbidden subgraph characterization if and only if  $\mathcal{C}$  has the induced hereditary property.*

**Theorem 1.2.2.** [12] *A graph  $G$  is a line graph if and only none of the nine graphs of Fig: 1.19 is an induced subgraph of  $G$ .*

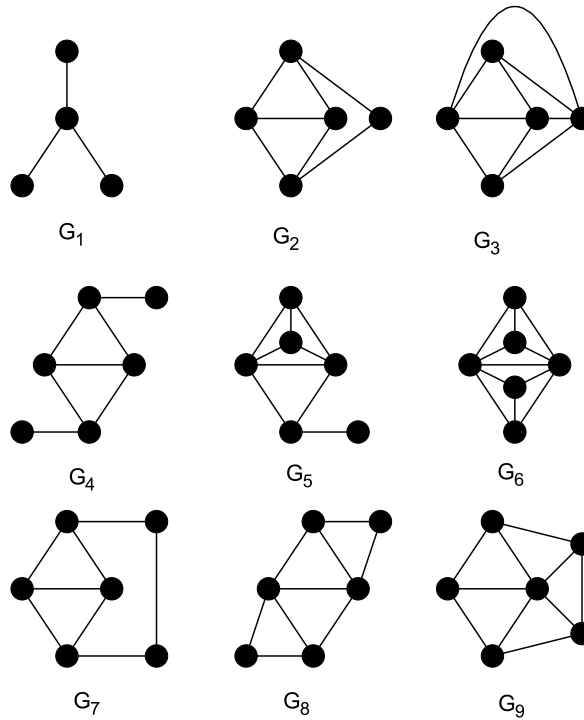

Fig 1.19: The nine forbidden subgraphs for line graphs

**Theorem 1.2.3.** [46] *A simple graph  $G$  is a line graph of some simple graph if and only if  $E(G)$  has a partition into cliques using each vertex of  $G$  at most twice.*

**Theorem 1.2.4.** [50] *AntiGallai graphs do not admit a forbidden subgraph characterization.*

**Theorem 1.2.5. (Kuratowski's Theorem)** [47] *A graph is planar if and only if it has no subgraph homeomorphic to  $K_5$  or  $K_{3,3}$ .*

**Theorem 1.2.6.** *For any simple planar graph  $G$ ,  $\delta(G) \leq 5$ .*

**Theorem 1.2.7.** [36] *A graph  $G$  is outerplanar if and only if it has no subgraph homeomorphic to  $K_4$  or  $K_{2,3}$  except  $K_4-e$ .*

**Theorem 1.2.8.** [9] *A graph is bipartite if and only if it contains no odd cycles.*

### 1.3 A survey of previous results

This section is a survey of results related to that of ours.

The study of line graphs was initiated by Whitney [69] and independently by Krausz [46] and Ore [58]. Since then it has been extensively studied and subjected to generalizations such as super-line graphs [6], triangular line graphs [43], H-line graphs [20] etc. The triangular line graph is also known as the anti-Gallai graph of  $G$ ,  $antiGal(G)$  [50]. Some properties of  $antiGal(G)$  are studied in [5] and [3].

The behaviour of the sequence  $\{L_H^k(G)\}$  when  $H = K_3$ ,  $H = P_4, P_5$  or  $K_{1,n}, n \geq 3$  and  $H = C_4$  are analyzed in [43], [28], [20] and [21] respectively. Jarret [43] proved that, if  $H = C_3$ , then the sequence  $\{L_H^k(G)\}$  converges if and only if  $G$  has at least one triangle and every convergent sequence converges to  $mC_3, m \geq 1$ . In [20], it is proved that if  $\{L_H^k(G)\}$  converges to a connected limit graph, then  $H = C_n$  or  $H = P_n$  for some  $n \geq 3$ . Chartrand et al. in [21] showed that if  $G$  contains no subgraph isomorphic to  $K_1 \vee P_4, P_4 \square K_2, K_{2,3}, K_4$ , then the sequence  $L_{C_4}(G)$  converges to  $mC_4, m \geq 1$ . In [17], it is shown that the components of  $L_{K_n}(G)$  are always Eulerian. A sufficient condition for each component of  $L_{C_4}(G)$  to be Eulerian is obtained in [21]. In [32], Ghebleh et al. studied the planarity of

iterated line graphs and introduced the notion of the line index of a graph,  $\zeta(G)$ . They also characterized all graphs in terms of the line index. The outerplanarity of iterated line graphs is studied and the outerplanar line index is defined in [53].

The edges of  $G$  can be considered as cliques of order two. This point of view admits another generalization of line graphs, called triangle graphs ([7]). The cycle graph [31] can also be considered as a generalization of the triangle graph. Cycle-persistent and cycle-vanishing graphs are studied in [66].

The problem of finding a dominating set of minimum cardinality is an important problem that has been extensively studied. Our focus is on a variation called the power dominating set (PDS) problem. This type of domination is different from the standard domination type problem, since the domination rules can be iterated. In other words, the set  $M(S)$  is obtained from  $S$  as follows. First put into  $M(S)$  the vertices from the closed neighborhood of  $S$ . Then, repeatedly add to  $M(S)$  vertices  $w$  that have a neighbor  $v$  in  $M(S)$  such that all other neighbors

of  $v$  are already in  $M(S)$ . If no such vertex  $w$  exists, the set monitored by  $S$  has been constructed.

The problem of deciding if a graph  $G$  has a power dominating set of cardinality  $k$  has been shown to be NP-complete even for bipartite graphs, chordal graphs [37] or even split graphs [51]. On the other hand, the problem has efficient solutions on trees [37], as well as on interval graphs [51]. Other efficient algorithms have been presented for trees and more generally, for graphs with bounded treewidth [45]. The following results from [37], [27], [26], [11] are of interest to us.

**Theorem 1.3.1.** [37] *For any graph  $G$ ,  $1 \leq \gamma_p(G) \leq \gamma(G)$ , where  $\gamma_p(G)$  and  $\gamma(G)$  are the power domination number and domination number of  $G$  respectively. Also,  $\gamma_p(G) = 1$  for  $G \in \{K_n, C_n, P_n, K_{2,n}\}$ .*

**Theorem 1.3.2.** [37] *There is no forbidden subgraph characterization of the graphs  $G$  for which  $\gamma_p(G) = \gamma(G)$ .*

**Theorem 1.3.3.** [37] *If  $G$  is a graph with maximum degree at least three, then  $G$  contains a  $\gamma_p(G)$ -set in which every vertex has degree at least three.*

**Theorem 1.3.4.** [27] *If  $G$  is the grid graph  $P_n \square P_m$  where  $m \geq n \geq 1$ , then*

$$\gamma_p(G) = \lceil \frac{n+1}{4} \rceil, \text{ if } n \equiv 4 \pmod{8}.$$

$$\gamma_p(G) = \lceil \frac{n}{4} \rceil, \text{ otherwise.}$$

**Theorem 1.3.5.** [26] *Let  $n$  be even and  $C$  be a connected component of  $P_m \times P_n$ . If  $m$  is odd or  $m \geq n$ , then  $\gamma_p(C) = \lceil \frac{n}{4} \rceil$ .*

**Theorem 1.3.6.** [26] *Let  $m \leq n$  be odd and  $C$  be the component of  $P_m \times P_n$  containing the vertex  $(0,0)$ . Then,*

$$\gamma_p(C) = \max\{\lceil \frac{n}{4} \rceil, \lceil \frac{m+n}{6} \rceil\}.$$

**Theorem 1.3.7.** [11] *The power domination number for the cylinder  $G = P_n \square C_m$  is*

$$\gamma_p(G) \leq \min\{\lceil \frac{m+1}{4} \rceil, \lceil \frac{n+1}{2} \rceil\}, \text{ if } n \equiv 4 \pmod{8}.$$

$$\gamma_p(G) \leq \min\{\lceil \frac{m}{4} \rceil, \lceil \frac{n+1}{2} \rceil\}, \text{ otherwise.}$$

**Theorem 1.3.8.** [11] *The power domination number for the torus  $G = C_n \square C_m, n \leq m$  is*

$$\gamma_p(G) \leq \left\lceil \frac{n}{2} \right\rceil \text{ if } n \equiv 0 \pmod{4}.$$

$$\gamma_p(G) \leq \left\lceil \frac{n+1}{2} \right\rceil, \text{ otherwise.}$$

More generally, upper bounds for  $\gamma_p(G)$  for an arbitrary graph  $G$  were given by Zhao and Kang [72]. They proved that if  $G$  is an outerplanar graph with diameter two or a 2-connected outerplanar graph with diameter three, then  $\gamma_p(G) = 1$ . An upper bound is obtained in [71] as follows:

**Theorem 1.3.9.** [71] *Let  $\mathcal{T}$  be the family of graphs obtained from connected graphs  $H$  by adding two new vertices  $v'$  and  $v''$  to each vertex  $v$  of  $H$  and new edges  $vv'$  and  $vv''$ , while  $v'v''$  may be added or not. If  $G$  is a connected graph of order  $n \geq 3$ , then  $\gamma_p(G) \leq \frac{n}{3}$  with equality if and only if  $G \in \mathcal{T} \cup \{K_{3,3}\}$ .*

The hexagonal honeycomb grids were studied by Stojmenovic in [64],[65] and they offer a model for multiprocessor interconnection networks with similar properties to those of mesh-connected computer networks, which are also referred to as grid graphs. The network cost, defined as the product of degree

---

and diameter, is better for honeycomb grids than for the square grids, which makes it a suitable choice for interconnection networks. Some interesting works on hexagonal honeycomb grids are in [44] and [48] where they are referred to as benzenoid hydrocarbons.

Triangular grids have attracted great attention due to its wide applications in interconnection networks. The vertex bandwidth and the edge bandwidth of the triangular grid is obtained in [39] and [2], respectively. Evidence for grid cells in human memory network is discussed by Doeller et al. in [25] in which the authors have observed that the brain uses triangles instead of square grid lines to locate objects.

Mycielski introduced an interesting graph transformation which transforms a graph  $G$  into a graph  $\mu(G)$ , which we now call the Mycielskian of  $G$  [56]. He used this fascinating construction to create triangle-free graphs with large chromatic numbers. Earlier, the studies on Mycielskians was mainly focused on its chromatic number and its variations like circular chromatic number,



fractional chromatic number etc. [19], [49]. Later, various other parameters like hamiltonicity, diameter, domination etc were investigated in [30] and [52]. Recently, the edge-connectivity and vertex connectivity of  $\mu(G)$  has been studied by Balakrishnan et al. in [8].

## 1.4 Summary of the thesis

This thesis entitled ‘Studies on some generalizations of line graph and the power domination problem in graphs’ is centered around the graph operators-  $L_H(G)$  and  $Cy(G)$  and the corresponding graph classes-  $H$ -line graphs and cycle graphs. We also study the power domination problem in hexagonal and triangular grids, Mycielskian of graphs and graph products.

This thesis is divided into five chapters including an introductory chapter which contains the literature on graph operators and the power domination problem. It also include some basic definitions and terminology used in this thesis.

In the second chapter  $H$ -line graphs and iterated star line graphs are studied in detail. The main results in this chapter are:

- ★  $H$ -line graphs admit a forbidden subgraph characterization if and only if  $H = K_{1,2}$ .
- ★ A graph  $G$  is a star-line graph,  $L_{K_{1,n}}(G')$ ,  $n \geq 3$  if and only if  $E(G)$  has a partition into cliques of order at least  $n$  using each vertex of  $G$  at most twice.
- ★ Characterizations of graphs in terms of  $\zeta_3(G)$ ,  $\zeta_4(G)$  and  $\zeta_n(G)$ ,  $n \geq 5$ .

The third chapter is the study of another graph operator, the cycle graph,  $\text{Cy}(G)$ . Following are some of the results obtained.

- ✠ For any graph  $G$ ,  $\text{Cy}(G)$  is a tree if and only if  $G$  is outerplanar and all its cycles lie in the same block.
- ✠ The girth of a cycle graph is three.
- ✠ Let  $G$  be a chordal graph. Then,  $\text{Cy}(G)$  is chordal if and only if  $G$  does not contain  $K_5 - e$  as an induced subgraph.

- ✱ For any two integers  $a \geq 1, b \geq 1$ , there are graphs  $G$ , such that  $\gamma(G) = a$  and  $\gamma(\text{Cy}(G)) = b$ , where  $\gamma(G)$  is the domination number of  $G$ . Similar results for radius and diameter are also obtained.
- ✱ The cycle graph of  $G \square K_2$  is isomorphic to  $L(G)$  if and only if  $G$  is a forest.

The fourth chapter deals with the power domination problem in hexagonal and triangular grids. The main results are:

- ⊗ If  $G = \text{HM}_n$ , then  $\gamma_P(G) = \lceil \frac{2n}{3} \rceil$ .
- ⊗ If  $G = T_n$ , then  $\gamma_P(G) = \lceil \frac{n+1}{4} \rceil$ .
- ⊗ If  $G = \text{RT}_{m,n}$ , then  $\gamma_P(G) = \lceil \frac{m+1}{4} \rceil$ .

The power domination problem in more classes of graphs such as Mycielskians, direct product, Cartesian product etc. are discussed in the fifth chapter. The main results are listed below.

- ⊕ If  $G$  has a minimum power dominating set in which every vertex has a neighbor of outdegree one in  $S_1$ , then  $\gamma_P(\mu(G)) \leq \gamma_P(G)$ .

- ⊕ Let  $G$  be a connected graph with  $\gamma_p(\mu(G)) \leq \gamma_p(G)$  and  $\gamma_p(\mu(G)) \neq 1$ . Then  $\gamma_p(\mu(G)) = \gamma_p(G)$ .
- ⊕ If  $G$  is a connected graph, then  $\gamma_p(\mu(G)) \in \{1, \gamma_G, \gamma_p(G) + 1\}$ .
- ⊕ For every  $n \geq 1$ , there are graphs with  $\gamma_p(G) = n$  and  $\gamma_p(\mu(G)) = 1$ .
- ⊕ For an even integer  $n$ ,  $\gamma_p(\mu_m(P_n)) = 1$ .
- ⊕ For an integer  $m \geq 2$  and an odd integer  $n$ ,
- $$\gamma_p(\mu_m(P_n)) \leq \frac{m}{2} + 1, \text{ if } m \text{ is even.}$$
- $$\gamma_p(\mu_m(P_n)) \leq \frac{m+1}{2}, \text{ if } m \text{ is odd.}$$
- ⊕  $\gamma_p(K_m \times K_n) = 2$ , for  $m + n > 5$ .
- ⊕ Let  $m \geq 3$ ,  $n \geq 4$  and  $G = K_m \times C_n$ . Then
- $$\gamma_p(G) = 2k, \text{ if } n = 4k$$
- $$\gamma_p(G) = 2k + 1, \text{ if } n = 4k + 1$$
- $$\gamma_p(G) = 2k + 2, \text{ if } n = 4k + 2 \text{ or } n = 4k + 3.$$
- ⊕ Let  $n$  be an even integer and  $G = C_m \times P_n$ . Then
- $$\gamma_p(G) = 2 \left\lceil \frac{n}{3} \right\rceil, \text{ if } m \text{ is even.}$$
- $$\gamma_p(G) = \left\lceil \frac{n}{3} \right\rceil, \text{ if } m \text{ is odd.}$$

Some of the results in this thesis are included in [29], [60], [61], [62], [63]. The thesis is concluded with some suggestions for further study and a bibliography.

## 1.5 List of publications

### Papers presented

- ⊕ “Some properties of cycle graphs,” National Seminar on Algebra and Discrete Mathematics, University of Kerala, Trivandrum, November 14-17, 2007.
- ⊕ “Star-line graphs,” IMS Annual Conference, 2009, Kalasalingam University, Krishnankoil, Madurai, December 27-30, 2009.
- ⊕ “Power domination in triangular grids,” International Conference on Recent Trends in Graph Theory and Combinatorics-ICRTGC 2010, (A Satellite Conference of the International Congress of Mathematicians-ICM 2010), Cochin University of Science and Technology, Cochin, August 12-15, 2010.

### Papers accepted/submitted

- ★ Seema Varghese, A. Vijayakumar, On H-line graphs,(Submitted).
- ★ Seema Varghese, A. Vijayakumar, On the planarity of iterated star-line graphs,(Submitted).

- ★ Seema Varghese, A. Vijayakumar, Power domination in triangular grids and Mycielskian of graphs,(Submitted).
- ★ Seema Varghese, A. Vijayakumar, On cycle graphs,(Submitted).
- ★ D. Ferrero, Seema Varghese, A. Vijayakumar, Power domination in honeycomb networks, Journal of Discrete Mathematical Sciences and Cryptography,(to appear).

# Chapter 2

## *H*-line graphs

This chapter deals with the graph operator  $L_H(G)$  and the corresponding graph class, *H*-line graphs. We show that *H*-line graphs admit a forbidden subgraph characterization only when  $H = K_{1,2}$ . We also obtain a Krausz type characterization for star-line graphs. The notion of line index of a graph,  $\zeta(G)$  is generalized to  $\zeta_n(G)$ , ***n*-star-line-index** of a graph  $G$ . We also characterize graphs in terms of  $\zeta_3(G)$ ,  $\zeta_4(G)$  and  $\zeta_n(G)$ ,  $n \geq 5$ .

---

Some results of this chapter are included in the following papers.

1. Seema Varghese, A. Vijayakumar, On *H*-line graphs (Submitted).
2. Seema Varghese, A. Vijayakumar, On the planarity of iterated star-line graphs (Submitted).



## 2.1 Non-existence of forbidden subgraph characterization

Let  $H$  is a connected graph of order at least three. It is clear that  $L_H(G)$  is a spanning subgraph of  $L(G)$ .

**Lemma 2.1.1.** *If  $H$  is a graph with the edge-independence number,  $\alpha'(H) > 1$ , then  $K_n, n \geq 2$  is not an  $H$ -line graph.*

*Proof.* Suppose that  $\alpha'(H) > 1$  and  $e_1, e_2$  are any two independent edges in  $H$ . Since  $L_H(G)$  has an edge if and only if  $G$  contains a copy of  $H$ , the edges  $e_1, e_2$  will be independent in  $G$  also. Clearly, the vertices corresponding to  $e_1$  and  $e_2$  are not adjacent in  $L_H(G)$ .  $\square$

**Lemma 2.1.2.** *Every  $K_n$  is an induced subgraph of  $L_H(G)$  for some graph  $G$ .*

*Proof.* The graph  $G$  can be constructed as follows. With each pair of adjacent edges  $\{vv_i, vv_j\}$  of  $K_{1,n}$  construct a copy of  $H$ . In the newly constructed graph  $G$ , the edges  $\{vv_i, vv_j\}$  are adjacent and there is a copy of  $H$  containing both these

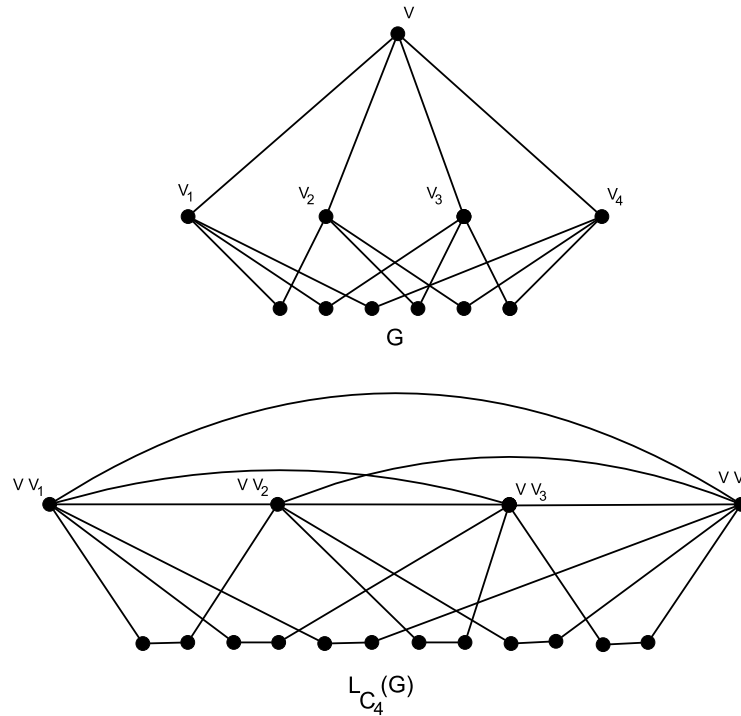

Fig 2.1:  $K_4$  is an induced subgraph of  $L_{C_4}(G)$

edges where  $i$  and  $j$  are integers such that  $1 \leq i, j \leq n$ . Hence  $\{vv_1, vv_2, \dots, vv_n\}$  will induce a  $K_n$  in  $L_H(G)$ .

**Note:** The case when  $H = C_4$  is illustrated in Fig: 2.1. □

Thus, it is clear from Lemma 2.1.2 that  $H$ -line graphs do not have induced hereditary property and hence, by Theorem 1.2.1 they lack forbidden subgraph characterization, if  $\alpha'(H) > 1$ . If  $\alpha'(H) = 1$ , then  $H$  is either  $K_{1,n}, n \geq 2$  or  $K_3$ .  $L_{K_{1,2}}(G)$ , which

is the line graph of  $G$ , admits a forbidden subgraph characterization (Theorem 1.2.2) but  $L_{K_3}(G)$  does not admit a forbidden subgraph characterization (Theorem 1.2.4). Now, we shall show that  $L_{K_{1,n}}(G)$ ,  $n \geq 3$  does not have the induced hereditary property.

**Lemma 2.1.3.** *If  $G$  is a  $H$ -line graph, then every edge of  $G$  lies in a copy of  $L(H)$ .*

*Proof.* Let  $G = L_H(G')$ . If there is an edge in  $G$ , then there will be a copy of  $H$  in  $G'$ . Then the edges in  $H \subseteq G'$  will induce a copy of  $L(H)$  in  $G$ .  $\square$

**Lemma 2.1.4.** *The graph  $C_m$ ,  $m \geq 4$  is not a  $L_{K_{1,n}}(G)$ ,  $n \geq 3$ , for any  $G$ .*

*Proof.* If  $C_m$ ,  $m \geq 4$  were a  $L_{K_{1,n}}(G)$ ,  $n \geq 3$ , then by Lemma 2.1.3, every edge of  $C_m$  would lie in a copy of  $L(K_{1,n}) \cong K_n$ ,  $n \geq 3$ .  $\square$

**Lemma 2.1.5.** *For  $m \geq 4$ , every  $C_m$  is an induced subgraph of  $L_{K_{1,n}}(G)$ ,  $n \geq 3$ , for some graph  $G$ .*

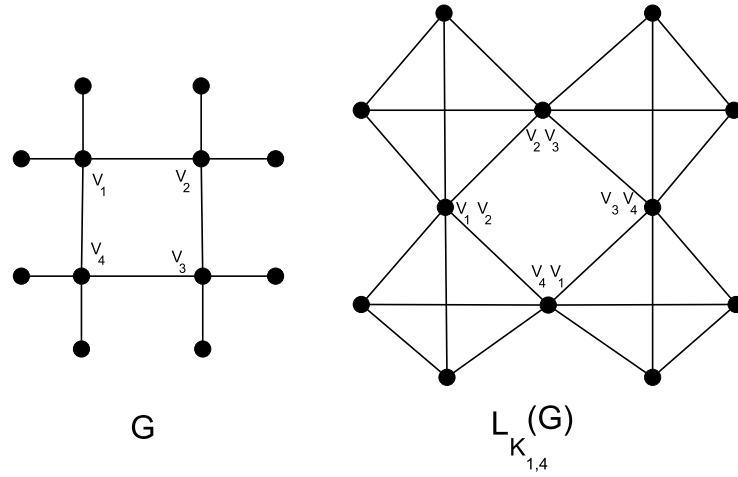

Fig 2.2:  $C_4$  is an induced subgraph of  $L_{K_{1,4}}(G)$

*Proof.* Let  $G = C_m \circ K_{n-2}^c$ . Then  $L_{K_{1,n}}(G)$  will contain  $C_m$  as an induced subgraph.

**Note:** The case when  $m = 4$  and  $n = 4$  is illustrated in Fig: 2.2.

□

**Theorem 2.1.6.** *H-line graphs admit a forbidden subgraph characterization if and only if  $H = K_{1,2}$ .*

*Proof.* The necessary part follows from Theorem 1.2.2. The sufficiency part follows from Theorem 1.2.4 and Lemmas 2.1.1 to 2.1.5.

□

## 2.2 Krausz-type characterization for star-line graphs

Analogous to the Theorem 1.2.3, the Krausz characterization of line graphs, we have the following theorem for star-line graphs.

**Theorem 2.2.1.** *A graph  $G$  is a star-line graph,  $L_{K_{1,n}}(G')$ ,  $n \geq 2$  if and only if  $E(G)$  has a partition into cliques of order at least  $n$  using each vertex of  $G$  at most twice.*

*Proof.* When  $n = 2$ , the theorem reduces to the Krausz characterization of line graphs. Suppose,  $G \cong L_{K_{1,n}}(G')$ , for some  $n \geq 3$ . Let  $v \in G'$  be such that  $\deg(v) \geq n$ . The edges incident to  $v$  will form a clique  $C_v$  of order at least  $n$  in  $G$ . Then,  $\mathcal{E} = \{C_v | v \in G' \text{ and } \deg(v) \geq n\}$  will form a clique cover of the edges of  $G$  in which every vertex of  $G$  is in at most two members of  $\mathcal{E}$ .

Conversely, suppose that  $G$  has an edge clique partition  $\mathcal{E}$  satisfying the condition of the theorem. Consider the intersection graph  $I(\mathcal{E})$ . Corresponding to every vertex of  $G$ , which

belong to exactly one clique  $C$  of  $\mathcal{E}$ , draw a pendant vertex to the vertex corresponding to  $C$  in  $I(\mathcal{E})$  and for every isolated vertex of  $G$ , draw an isolated edge. Let the newly constructed graph be  $G'$ . Now we shall show that  $L_{K_{1,n}}(G') \cong G$ . Define  $\phi : V(G) \rightarrow V(L_{K_{1,n}}(G'))$  as follows: If  $v \in V(G)$  is such that  $v \in C_i \cap C_j$ , then  $C_i$  and  $C_j$  are adjacent in  $I(\mathcal{E})$  and define  $\phi(v)$  to be the edge in  $G'$  joining  $C_i$  and  $C_j$ . If  $v \in C_i$  only, then there will be a pendant vertex in  $G'$  corresponding to  $v$  and define  $\phi(v)$  to be the pendant edge attached to  $C_i$ . If  $v$  is an isolated vertex in  $G$ , define  $\phi(v)$  to be the isolated edge in  $G'$  corresponding to  $v$ . It is clear that  $\phi$  is a well-defined bijection. Let  $u$  and  $v$  be adjacent vertices in  $G$ . Then  $u$  and  $v$  belong to a clique  $C_i$  of the partition. Since every clique of the partition is of order at least  $n$ , there are vertices  $w_1, w_2 \dots w_{n-2}$  in  $C_i$ . The construction of  $G'$  is such that edges corresponding to these vertices  $u, v, w_1, w_2 \dots w_{n-2}$  will have a common vertex forming a  $K_{1,n}$  in  $G'$ . Thus the edges corresponding to  $u$  and  $v$  are adjacent and lie in a common copy of  $K_{1,n}$  in  $G'$  and hence  $u$  and  $v$  are adjacent in  $L_{K_{1,n}}(G')$ . Therefore,  $\phi$  is an isomorphism.  $\square$

**Corollary 2.2.2.**  $L_{K_{1,n}}(G), n \geq 3$  is a line graph in which every edge lies in a  $K_n$ .

### 2.3 3-star-line-index of a graph

In this section, we characterize graphs in terms of  $\zeta_3(G)$ .

**Lemma 2.3.1.** *If  $G'$  is a subgraph of  $G$ , then  $\zeta_n(G) \leq \zeta_n(G')$ .*

*Proof.* Let  $\zeta_n(G') = k$ . Then,  $L_{K_{1,n}}^k(G')$  is nonplanar and so is  $L_{K_{1,n}}^k(G)$ , since  $G'$  is subgraph of  $G$ .  $\square$

**Lemma 2.3.2.** *If  $G$  is a graph with  $\Delta(G) \geq 4$ , then  $\zeta_3(G) \leq 3$ .*

*Proof.* If  $\Delta(G) \geq 4$ , then  $G$  contains  $K_{1,4}$  as a subgraph and  $L_{K_{1,3}}^3(K_{1,4})$  (Fig: 2.3) is a 6-regular graph and hence is nonplanar by Theorem 1.2.6. Therefore,  $\zeta_3(K_{1,4}) \leq 3$  and by Lemma 2.3.1,  $\zeta_3(G) \leq 3$ .  $\square$

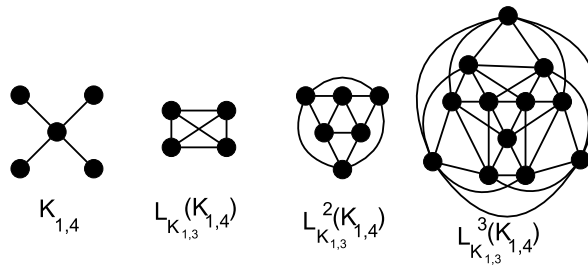

Fig 2.3:  $L_{K_{1,3}}^3(K_{1,4})$

**Lemma 2.3.3.** *For any graph  $G$ ,  $\zeta_3(G) \in \{0, 1, 2, 3, 4, \infty\}$ . Also,  $\zeta_3(G) = \infty$  if and only if  $\Delta(G) \leq 3$  and no two vertices in  $G$  of degree three are adjacent .*

*Proof.* If  $\Delta(G) \geq 4$ , by Lemma 2.3.2, we have  $\zeta_3(G) \leq 3$ . If  $\Delta(G) \leq 2$ , then  $G$  does not contain  $K_{1,3}$  as a subgraph and hence  $L_{K_{1,3}}(G)$  is totally disconnected. Therefore  $\zeta_3(G) = \infty$ . If  $\Delta(G) = 3$  and  $G$  does not have two adjacent vertices of degree three, then  $L_{K_{1,3}}^2(G)$  will be totally disconnected and hence  $\zeta_3(G) = \infty$ . If  $G$  has two adjacent vertices of degree three, then  $L_{K_{1,3}}^2(G)$  will have  $K_4$  as a subgraph and  $L_{K_{1,3}}^2(K_4)$  is a 6-regular graph (Fig: 1.9) which is non-planar. Hence  $\zeta_3(G) = 4$ .  $\square$

**Lemma 2.3.4.** *For any graph  $G$ ,  $L_{K_{1,3}}(G)$  is planar if and only if  $G$  satisfies the following:*

- (i)  $\Delta(G) \leq 4$ .
- (ii)  $G$  does not contain any one of the graphs  $H_1$  or  $H_2$  in Fig 2.4 as a subgraph.
- (iii)  $G$  does not contain any subgraph homeomorphic to  $K_{3,3}$  in which degree of every vertex in  $G$  is at least three.

**Note:** An edge with a single end vertex shows the degree of

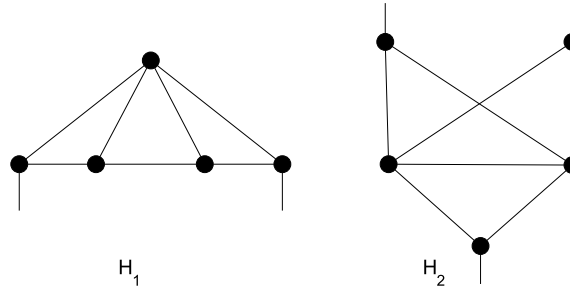

Fig 2.4:  $H_1$  and  $H_2$ 

that vertex. In Fig 2.4, the degree is three.

*Proof.* If  $\Delta(G) \geq 5$ , then  $L_{K_{1,3}}(G)$  contains  $K_5$  as a subgraph and hence it is nonplanar by Theorem 1.2.5. Also, if  $G$  has any one of the graphs  $H_1$  or  $H_2$  as a subgraph, then  $L_{K_{1,3}}(G)$  will contain any one of the graphs  $H'_1$  or  $H'_2$  in Fig 2.5 as a subgraph. Both graphs  $H'_1$  or  $H'_2$  are non planar by Theorem 1.2.5 and hence  $L_{K_{1,3}}(G)$  is nonplanar.

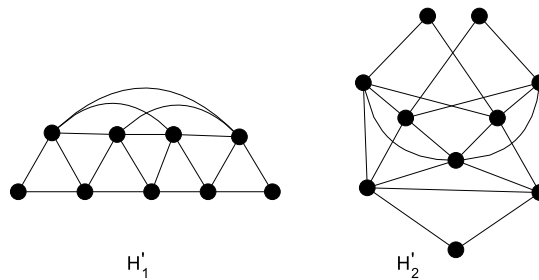
Fig 2.5:  $H'_1$  and  $H'_2$

For the necessity of condition (iii) we prove the following,

**Claim 2.3.1.** If  $G$  has a subgraph homeomorphic to  $G'$  in which degree of every vertex in  $G$  is at least three, then  $L_{K_{1,3}}(G)$  has a subgraph homeomorphic to  $L_{K_{1,3}}(G')$ .

Let  $u_1u_2$  be an edge of  $G'$  and  $u$  be the vertex in  $L_{K_{1,3}}(G')$  corresponding to the edge  $u_1u_2$ . Suppose that the edge  $u_1u_2$  is subdivided by the vertex  $u_3$  whose degree in  $G$  is at least three as in Fig 2.6. Then the edges  $u_3u_1, u_3u_2, u_3v_1, u_3v_2 \dots u_3v_{n-2}$

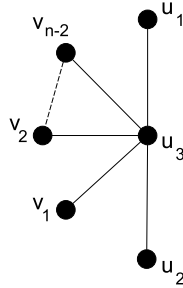

Fig 2.6: The edge  $u_1u_2$  subdivided

will form a clique  $C_u$  in  $L_{K_{1,3}}(G)$ . Now, the vertices which were adjacent to  $u$  in  $L_{K_{1,3}}(G')$  will be adjacent to the vertices corresponding to  $u_3u_1$  and  $u_3u_2$  in  $L_{K_{1,3}}(G)$ . Thus, corresponding to every edge of  $L_{K_{1,3}}(G')$ , we get a path in  $L_{K_{1,3}}(G)$  and hence it

contains a subgraph homeomorphic to  $L_{K_{1,3}}(G')$ .

Hence, if  $G$  has a subgraph homeomorphic to  $K_{3,3}$  in which degree of every vertex in  $G$  is at least three, then  $L_{K_{1,3}}(G)$  has a subgraph homeomorphic to  $L_{K_{1,3}}(K_{3,3})$  ( Fig 2.7) which is non-planar.

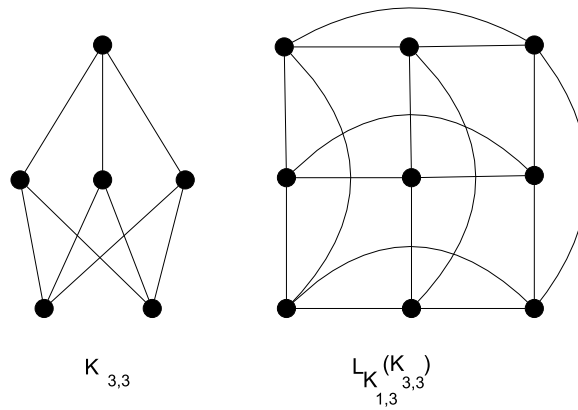

Fig 2.7:  $K_{3,3}$  and  $L_{K_{1,3}}(K_{3,3})$

Conversely, suppose that  $L_{K_{1,3}}(G)$  is nonplanar. Then, it contains a subgraph homeomorphic to  $K_5$  or  $K_{3,3}$ .

**Case 1.**  $L_{K_{1,3}}(G)$  contains  $K_5$  or a subgraph homeomorphic to  $K_5$ .

If  $L_{K_{1,3}}(G)$  contains  $K_5$ , then there are five mutually incident edges in  $G$  and  $\Delta(G) \geq 5$ , which is a contradiction. If  $L_{K_{1,3}}(G)$  has a copy of  $K_5$  with one edge subdivided once or twice, then it contains either a copy of  $G_a$  or a copy of  $G_b$  in Fig 2.8 as an induced subgraph. If  $L_{K_{1,3}}(G)$  has a copy of  $K_5$

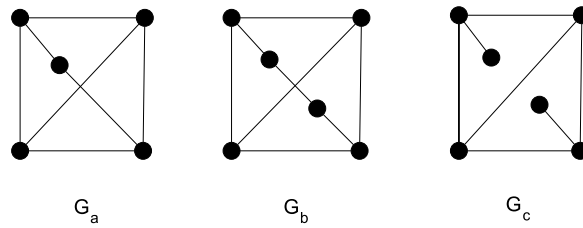

Fig 2.8:  $G_a, G_b$  and  $G_c$

with one edge subdivided more than twice then it contains a copy of  $G_c$  as an induced subgraph. If  $L_{K_{1,3}}(G)$  has a copy of  $K_5$  with more than one edge subdivided, then it has a copy of  $K_{1,3}$  as an induced subgraph. All the graphs  $G_a, G_b, G_c, K_{1,3}$  are forbidden subgraphs for line graphs by Theorem 1.2.2 and hence are forbidden for star-line graphs also by Corollary 2.2.2. Hence,  $L_{K_{1,3}}(G)$  cannot have any subgraph homeomorphic to  $K_5$  other than  $K_5$ .

**Case 2.**  $L_{K_{1,3}}(G)$  contains  $K_{3,3}$  or a homeomorphic copy of  $K_{3,3}$  as a subgraph.

In this case,  $L_{K_{1,3}}(G)$  contains  $K_{1,3}$  as an induced subgraph which is forbidden for star-line graphs. Also, any edge in  $L_{K_{1,3}}(G)$  will lie in a triangle and any two cliques in the edge-clique partition of  $L_{K_{1,3}}(G)$  can have at most one common vertex. These conditions will force  $L_{K_{1,3}}(G)$  to have a copy of  $K_5$  or a homeomorphic copy of  $K_{3,3}$  in which degree of every vertex in  $G$  is at least three. But, then  $\Delta(G)$  will be greater than four.  $\square$

**Lemma 2.3.5.** *For any graph  $G$ ,  $\zeta_3(G) = 1$  if and only if  $G$  is planar and contains any one of the graphs  $K_{1,5}$ ,  $H_1$  or  $H_2$  in Fig 2.4 as a subgraph.*

*Proof.* Follows from Lemma 2.3.4.  $\square$

**Lemma 2.3.6.** *For any graph  $G$ ,  $\zeta_3(G) = 2$  if and only if  $L_{K_{1,3}}(G)$  is planar and  $G$  contains any one of the graphs in Fig 2.9 as a subgraph.*

*Proof.* By Lemma 2.3.5,  $\zeta_3(G) = 2$  if and only if  $L_{K_{1,3}}(G)$  is planar and has any one of the graphs  $K_{1,5}$ ,  $H_1$  or  $H_2$  in Fig: 2.4 as a subgraph. As in the proof of Lemma 2.3.4, it follows that this is possible if and only if  $G$  has any one of the graphs in Fig 2.9 as a subgraph.  $\square$

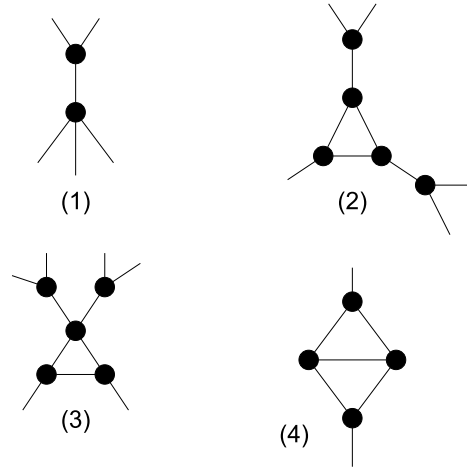

Fig 2.9:

**Lemma 2.3.7.** *For any graph  $G$ ,  $\zeta_3(G) = 4$  if and only if  $\Delta(G) \leq 3$ ,  $G$  is planar and has two adjacent vertices of degree three and does not have any one of the graphs in Fig 2.10 as a subgraph.*

*Proof.* If  $\Delta(G) \geq 4$ , we have by Lemma 2.3.2 that  $\zeta_3(G) \leq 3$ . Also,  $\zeta_3(G)$  of the graphs (1) and (2) in Fig 2.10 is two and that of the graph (3) in Fig 2.10 is three. Hence, if  $G$  contains any of these graphs as subgraphs, then by Lemma 2.3.1,  $\zeta_3(G) \leq 3$ . Now, if  $\Delta(G) \leq 3$  and  $G$  does not have two adjacent vertices

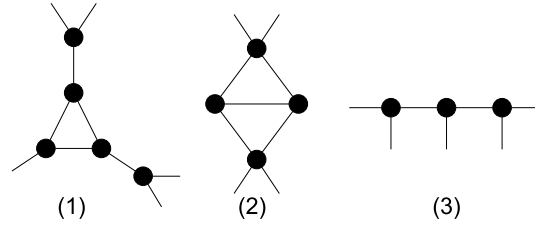

Fig 2.10:

of degree three, then  $L_{K_{1,3}}^2(G)$  will be totally disconnected and  $\zeta_3(G) = \infty$ .  $\square$

We thus have,

**Theorem 2.3.8.** *Let  $G$  be any graph. Then,*

- (1)  $\zeta_3(G) = \infty$ , if and only if  $\Delta(G) \leq 3$  and  $G$  does not contain two adjacent vertices of degree three.
- (2)  $\zeta_3(G) = 0$ , if and only if  $G$  is non-planar.
- (3)  $\zeta_3(G) = 1$ , if and only if  $G$  is planar and contains any one of the graphs  $K_{1,5}$ ,  $H_1$  or  $H_2$  in Fig 2.4 as a subgraph.
- (4)  $\zeta_3(G) = 2$ , if and only if  $L_{K_{1,3}}(G)$  is planar and  $G$  contains any one of the graphs in Fig 2.9 as a subgraph.

(5)  $\zeta_3(G) = 4$ , if and only if  $\Delta(G) \leq 3$ ,  $G$  is planar and has two adjacent vertices of degree three and does not contain any one of the graphs in Fig 2.10 as a subgraph.

(6)  $\zeta_3(G) = 3$ , otherwise. □

## 2.4 4-star-line-index of a graph

In this section, we characterize all graphs in terms of  $\zeta_4(G)$ . We first state two lemmas which can be proved as in the previous section and use it to compute the value of  $\zeta_4(G)$ .

**Lemma 2.4.1.** *Let  $G$  be any graph. Then  $L_{K_{1,4}}(G)$  is planar if and only if  $G$  satisfies the following:*

(i)  $\Delta(G) \leq 4$ .

(ii)  $G$  does not contain any one of the graphs  $H_3$  or  $H_4$  in Fig 2.11 as a subgraph.

(iii)  $G$  does not contain any subgraph homeomorphic to  $K_{3,3}$  in which degree of every vertex in  $G$  is at least four .

**Lemma 2.4.2.** *For any graph  $G$ ,  $\zeta_4(G) = 2$  if and only if  $L_{K_{1,4}}(G)$  is planar and  $G$  has any one of the graphs in Fig 2.12 as a subgraph.*



Fig 2.11:  $H_3$  or  $H_4$ 

Fig 2.12:

**Lemma 2.4.3.** *Let  $G$  be any graph. Then,  $\zeta_4(G) = \{0, 1, 2, \infty\}$ .*

*Proof.* For any graph  $G$ ,  $\zeta_4(G) = 3$  if and only if  $L_{K_{1,4}}^2(G)$  contains any one of the graphs  $K_{1,5}$ ,  $H_3$  or  $H_4$  as a subgraph. Also, if  $L_{K_{1,4}}^2(G)$  contains any of these graphs, then  $G$  has any

one of the graphs in Fig 2.12 as a subgraph, which implies that  $L_{K_{1,4}}^2(G)$  is nonplanar and  $\zeta_4(G) = 2$ .  $\square$

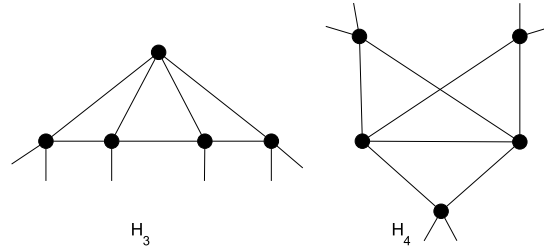
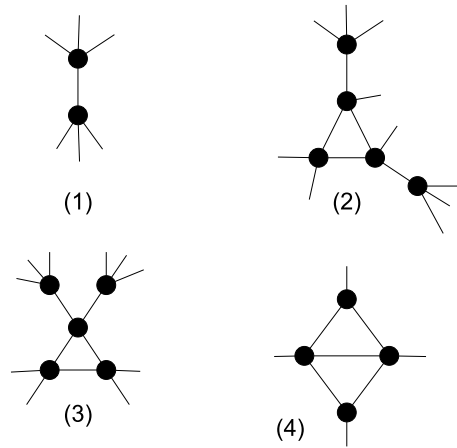
We summarize these results as follows.

**Theorem 2.4.4.** *Let  $G$  be any graph. Then,*

- (1)  $\zeta_4(G) = 0$ , if and only if  $G$  is non-planar.
- (2)  $\zeta_4(G) = 1$ , if and only if  $G$  is planar and contains any one of the graphs  $K_{1,5}$ ,  $H_3$  or  $H_4$  in Fig 2.11 as a subgraph.
- (3)  $\zeta_4(G) = 2$ , if and only if  $L_{K_{1,4}}(G)$  is planar and  $G$  contains any one of the graphs in Fig 2.12 as a subgraph.
- (4)  $\zeta_4(G) = \infty$ , otherwise.  $\square$

## 2.5 n-star-line-index of a graph

**Theorem 2.5.1.** *For  $n \geq 5$  and for any graph  $G$ ,  $\zeta_n(G) \in \{0, 1, \infty\}$ . Also,*

- (1)  $\zeta_n(G) = 0$ , if and only if  $G$  is non-planar.

(2)  $\zeta_n(G) = \infty$ , if and only if  $G$  is planar and  $\Delta(G) \leq 4$ .

(3)  $\zeta_n(G) = 1$ , otherwise.

*Proof.*  $L_{K_{1,n}}(G)$ ,  $n \geq 5$  will have an edge if and only if  $\Delta(G) \geq 5$  and in that case the edges incident on the vertex with maximum degree will induce a  $K_5$  in  $L_{K_{1,n}}(G)$  which makes it nonplanar. Hence,  $\zeta_n(G) = 1$ . If  $G$  is nonplanar, then  $\zeta_n(G) = 0$ . If  $G$  is planar and  $\Delta(G) \leq 4$ , then  $L_{K_{1,n}}(G)$ ,  $n \geq 5$  is an edgeless graph and hence  $\zeta_n(G) = \infty$ .  $\square$

# Chapter 3

## Cycle graphs

This chapter deals with the graph operator  $Cy(G)$  and cycle graphs, the corresponding graph class. We prove that  $Cy(G)$  is a tree if and only if  $G$  is outerplanar and all cycles lie in a single block. We obtain the girth of a cycle graph. We also obtain the condition for a cycle graph to be chordal. We also investigate the relationship between the parameters— domination number, radius and diameter of a graph and its cycle graph.

---

Some results of this chapter are included in the following paper.  
1. Seema Varghese, A. Vijayakumar, On cycle graphs (Submitted).

### 3.1 Cycle graph of outerplanar graphs

The cycle graph of a connected graph need not be connected as in Fig: 3.1. But, for the cycle graphs to be connected we have the following condition.

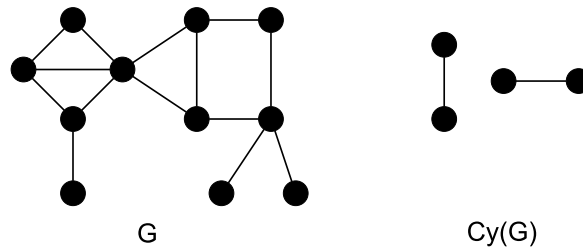

Fig 3.1: Disconnected  $Cy(G)$

**Lemma 3.1.1.** *For any graph  $G$ ,  $Cy(G)$  is connected if and only if all its cycles lie in the same block.*

*Proof.* Suppose that all the cycles of  $G$  lie in the same block. Let  $u$  and  $v$  be any two vertices of  $Cy(G)$  and  $\mathcal{C}_u$  be the component of  $Cy(G)$  containing  $u$ . Let  $\mathcal{B}_u$  denote the subgraph of  $G$  containing all the cycles corresponding to the vertices of  $\mathcal{C}_u$ . Let  $C_v$  be the cycle in  $G$  corresponding to  $v$ . Since all the cycles lie in the same block,  $\mathcal{B}_u$  and  $C_v$  share a common edge and  $v$  is adjacent to a vertex of  $\mathcal{C}_u$  which implies that  $v \in \mathcal{C}_u$ . The

converse is clear.  $\square$

**Lemma 3.1.2.** *For any graph  $G$ ,  $Cy(G)$  is acyclic if and only if  $G$  is outerplanar.*

*Proof.* We shall prove by induction on the order  $n$  of  $G$  that if  $G$  is outerplanar, then  $Cy(G)$  is acyclic. If  $n = 3$ , then the only outerplanar graph is  $K_3$  whose cycle graph is  $K_1$ . If  $n = 4$ , then the only outerplanar graphs are  $C_4$  and  $K_4 - e$  whose cycle graphs are  $K_1$  and  $K_2$ , respectively. Hence, the result is true for  $n = 3$  and  $n = 4$ . Assume that the result is true for all outerplanar graphs with less than  $n$  vertices and let  $G$  be an outerplanar graph with  $n$  vertices. If all the vertices of  $G$  are of degree two, then  $G$  is a cycle and the result is true. Otherwise, it is possible to label the outercycle of  $G$  as  $v_1v_2v_3 \dots v_n$ , such that  $\langle v_1v_2 \dots v_i \rangle$  is a cycle and the degree of the vertices  $v_2, \dots, v_{i-1}$  is two. Then, the induction hypothesis holds good for the graph  $G' = \langle v_1, v_i, v_{i+1} \dots v_n \rangle$  and  $Cy(G')$  is acyclic. Also,  $Cy(G)$  can be obtained from  $Cy(G')$  by attaching a pendant vertex and hence  $Cy(G)$  is also acyclic.

Conversely, suppose that  $G$  is non-outerplanar. Then  $G$  con-

tains a subgraph homeomorphic to  $K_4$  or  $K_{2,3}$  except  $K_4-e$  and then  $\text{Cy}(G)$  contains cycles.  $\square$

We thus obtain a necessary and sufficient condition for  $\text{Cy}(G)$  to be a tree.

**Theorem 3.1.3.** *For any graph  $G$ ,  $\text{Cy}(G)$  is a tree if and only if  $G$  is outerplanar and all its cycles lie in the same block.*  $\square$

**Theorem 3.1.4.** *Every tree is a cycle graph of an outerplanar graph.*

*Proof.* Let  $T$  be a tree with  $n$  vertices. Let  $n_i$  denote the number of vertices with degree  $i$ . Then we can construct a graph  $H$  of order  $N$  such that  $\text{Cy}(H) \cong T$  as follows. Let the vertices of  $T$  be labeled as  $v_1, v_2, \dots, v_n$  and  $d_j$  be the degree of  $v_j$ . Let  $C_{v_j}$  be the induced cycle in  $H$  corresponding to  $v_j$ . For vertices of degree one or two in  $T$ , take  $C_{v_j}$  to be a triangle. For all other vertices of degree exceeding two, take  $C_{v_j}$  to be a cycle of length  $d_{v_j}$ . If  $v_j$  is adjacent to  $v_k$ , make the cycles  $C_{v_j}$  and  $C_{v_k}$  edge intersecting. The graph  $H$  thus obtained will have  $\text{Cy}(H) \cong T$  and is outerplanar by Theorem 3.1.3.  $\square$

**Note:**

Since  $T$  has  $n$  vertices,  $H$  has  $n$  induced cycles. Since an edge  $e$  common to three cycles will give rise to a  $K_3$  in  $\text{Cy}(H)$  which is a tree, every edge of  $H$  can be in at most two cycles. Therefore, there should be  $n_i$  induced cycles of length  $i$ , for  $i = 3, 4 \dots \Delta$ . Each edge of  $T$  corresponds to a shared edge in  $H$  and hence,  $N = [3(n_1 + n_2 + n_3) + 4n_4 + 5n_5 + \dots + \Delta n_\Delta] - 2(n - 1)$ . This construction is illustrated in Fig: 3.2.

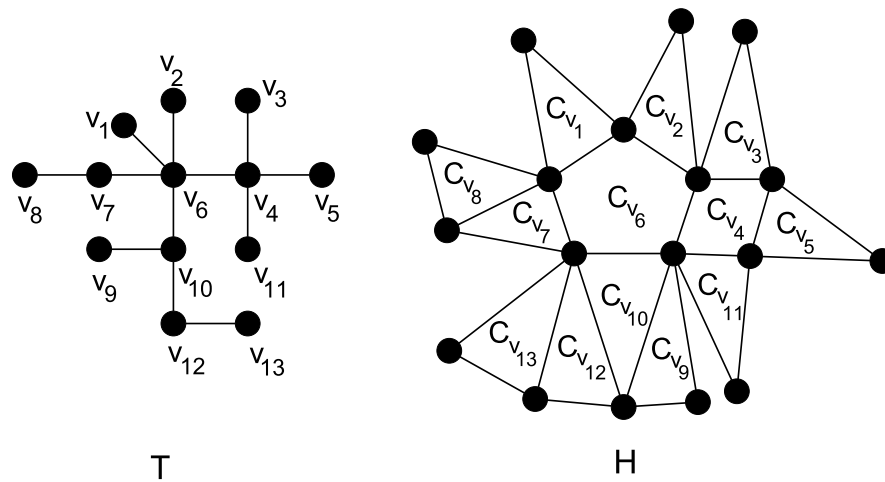
Fig 3.2:  $\text{Cy}(H) = T$ 

However, an inverse cycle graph of a tree need not be unique as illustrated in Fig: 3.3.



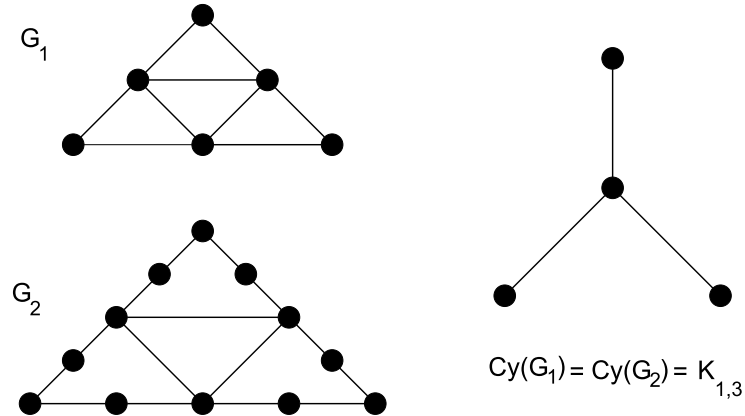

Fig 3.3: Non-isomorphic graphs with isomorphic  $\text{Cy}(G)$ .

In what follows, we denote by  $H$ , the graph constructed in the proof of Theorem 3.1.4.

**Theorem 3.1.5.** *Let  $T$  be any tree and  $G$  be a graph such that  $\text{Cy}(G) \cong T$ . Then  $G$  is contractible to  $H$  by the contraction of edges which do not lie in a triangle.*

*Proof.* Corresponding to any tree  $T$  of order  $n$ , by the construction in the proof of Theorem 3.1.4 there exists a graph  $H$  such that  $\text{Cy}(H) \cong T$ . Also, any induced cycle  $C_i$  of  $H$  with length greater than three have no unshared edges. Let  $G$  be a graph such that  $\text{Cy}(G) \cong T$ . Then  $G$  has  $n$  induced cycles  $C_1, C_2, \dots, C_n$ . All the unshared edges of  $G$ , which do not lie in a

triangle can be contracted without affecting its cycle structure. Hence  $G$  is contractible to  $H$ .  $\square$

Let  $T$  be any tree and  $G$  be a graph contractible to  $H$ . Since  $H$  is a contraction of  $G$ , all the induced cycles of  $H$  are induced cycles of  $G$  which preserves edge intersections also. Hence,  $\text{Cy}(G) \supseteq T$ . However, the converse of the Theorem 3.1.5 need be not true as illustrated in the following example (Fig: 3.4).

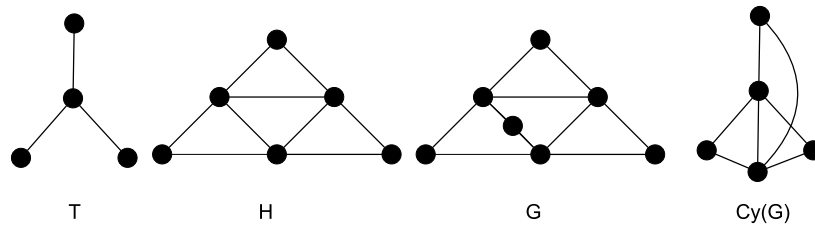

Fig 3.4:  $\text{Cy}(G)$  contains  $T$

## 3.2 The girth of a cycle graph

We first note that if a graph  $G$  has a cycle, then it has an induced cycle. In the following, we assume that  $\text{Cy}(G)$  has at least one cycle.

**Theorem 3.2.1.** *The girth of a cycle graph is three.*

*Proof.* Suppose that  $g(\text{Cy}(G)) = n \geq 4$  and  $C_n = \langle v_1, v_2, \dots, v_n \rangle$  is an induced cycle of length  $n$ . Let  $C_{v_i}$  be the induced cycle in  $G$  corresponding to  $v_i$ . Then,

**Claim 3.2.1.**  $C_{v_i}$  and  $C_{v_j}$  can have at most one common edge.

Suppose that  $C_{v_i}$  and  $C_{v_j}$  have more than one common edge. Then, the unshared edges of  $C_{v_i}$  and  $C_{v_j}$  will form another induced cycle  $C_{v_{ij}}$ . Now  $C_{v_i}, C_{v_j}$  and  $C_{v_{ij}}$  are three mutually edge intersecting induced cycles which will form a triangle in  $\text{Cy}(G)$ .

**Claim 3.2.2.** An edge in  $G$  can be common to at most two induced cycles.

An edge common to three induced cycles will form a triangle in  $\text{Cy}(G)$ .

**Claim 3.2.3.**  $C_{v_i}$  can have common vertices only with  $C_{v_{i-1}}$  and  $C_{v_{i+1}}$

Suppose that a vertex  $x$  is common to  $C_{v_i}$  and  $C_{v_{i+k}}, k > 1$  and let  $i$  and  $i+k$  be the smallest indices for which this holds

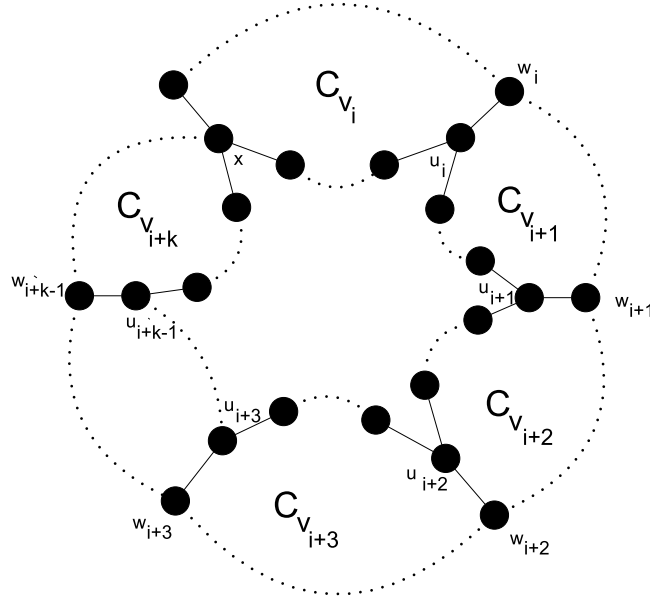

Fig 3.5:  $C_{v_i}$  and  $C_{v_{i+k}}$  sharing a common vertex  $x$ .

(Fig: 3.5). Let  $u_i w_i, u_{i+1} w_{i+1}, u_{i+2} w_{i+2} \dots, u_{i+k} w_{i+k}$  be the edges shared by  $(C_{v_i}, C_{v_{i+1}}), (C_{v_{i+1}}, C_{v_{i+2}}), (C_{v_{i+2}}, C_{v_{i+3}}), \dots, (C_{v_{i+k}}, C_{v_{i+k+1}})$ , respectively. Let  $p \xrightarrow{C} q$  denote the path from  $p$  to  $q$  along the cycle  $C$ . Then  $x \xrightarrow{C_{v_i}} u_i \xrightarrow{C_{v_{i+1}}} u_{i+1} \xrightarrow{C_{v_{i+2}}} u_{i+2} \dots u_{i+k-1} \xrightarrow{C_{v_{i+k}}} u_{i+k} \xrightarrow{C_{v_{i+k}}} x$  will form an inner induced cycle  $C'$ . Now,  $C', C_{v_i}, C_{v_{i+1}}$  will form a triangle in  $Cy(G)$ .

It follows that the induced cycles  $C_{v_1}, C_{v_2}, C_{v_3} \dots C_{v_n}$  in  $G$  are as shown in Fig: 3.6 and  $u_1 \xrightarrow{C_{v_2}} u_2 \xrightarrow{C_{v_3}} u_3 \dots u_{n-1} \xrightarrow{C_{v_n}} u_n \xrightarrow{C_{v_1}} u_1$  will form an inner induced cycle  $C''$  which intersects with  $C_{v_i}$

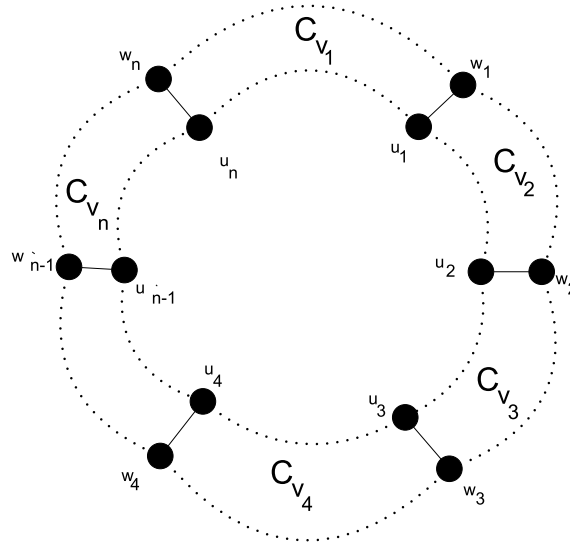

Fig 3.6: The induced cycles in  $G$  corresponding to an induced cycle  $Cy(G)$ .

and  $C_{v_{i+1}}$  forming a triangle in  $Cy(G)$ .  $\square$

**Corollary 3.2.2.**  $C_n, n \geq 4$  are not cycle graphs.

**Remark 3.2.1.** Wheels graphs  $W_n$  are cycle graphs, since  $Cy(W_n) = W_n$ . But, the outer cycle of a wheel which is its induced subgraph is not a cycle graph if  $n \geq 4$ . Therefore, cycle graphs do not have the induced hereditary property and hence cannot have a forbidden subgraph characterization.

**Corollary 3.2.3.** For any graph  $G$ ,  $Cy(G)$  is bipartite if

and only if  $G$  is outerplanar.

*Proof.* We know that a graph is bipartite if and only if it contains no odd cycles. Also, by Theorem 3.2.1, girth of  $\text{Cy}(G)$  is three. Thus,  $\text{Cy}(G)$  is odd cycle free if and only if it is acyclic. But, by Lemma 3.1.2, this happens if and only if  $G$  is outerplanar.  $\square$

### 3.3 Chordal cycle graphs

In this section, we derive the condition for a cycle graph to be chordal.

**Theorem 3.3.1.** *For any graph  $G$ , then  $\text{Cy}(G)$  is chordal if and only if  $G$  does not contain a wheel,  $W_n, n \geq 4$  or any subgraph that can be contracted to a wheel,  $W_n, n \geq 4$ .*

*Proof.* The sufficiency part follows since  $\text{Cy}(W_4) \cong W_4$  (Fig: 3.7) is not a chordal graph. Now, suppose that  $\text{Cy}(G)$  is not chordal. Then it contains a cycle  $C$  of length  $n \geq 4$  and  $G$  has  $n$  induced cycles  $C_1, C_2, \dots, C_n$  such that  $C_1$  shares a common edge with

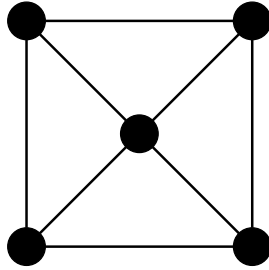

Fig 3.7:  $Cy(W_4) \cong W_4$

$C_2$  and  $C_n$ ;  $C_n$  shares a common edge with  $C_{n-1}$  and  $C_1$ ;  $C_i$  shares a common edge with  $C_{i-1}$  and  $C_{i+1}$ , for  $i = 2, 3, \dots, n$ . We consider two cases:

**Case 1.** All  $C_i$ 's have a common vertex.

In this case, let the common vertex be  $v$ . This will give rise to a wheel,  $W_n$  with  $n \geq 4$  in  $G$ .

**Case 2.** All  $C_i$ 's do not have a common vertex.

In this case,  $G$  will contain a subgraph shown in Fig: 3.6. It is clear that this subgraph can be contracted to a wheel,  $W_n$  with  $n \geq 4$ . □

### 3.4 Domination number, radius and diameter

In this section, we show that the difference between the domination number of  $G$  and  $\text{Cy}(G)$  can be arbitrary. Similar results for radius and diameter of  $\text{Cy}(G)$  are also proved.

**Theorem 3.4.1.** *For any two integers  $a \geq 1, b \geq 1$ , there are graphs  $G$ , such that  $\gamma(G) = a$  and  $\gamma(\text{Cy}(G)) = b$ , where  $\gamma(G)$  is the domination number of  $G$ .*

*Proof.*

**Case 1.**  $a = 1$  and  $b = 1$ .

Take  $G$  to be  $W_5$ . Then  $\gamma(W_5) = 1 = a$ . Also,  $W_5$  is cycle fixed. Hence,  $\gamma(\text{Cy}(G)) = 1 = b$ .

**Case 2.**  $a = 1$  and  $b > 1$ .

Take  $W_5$  and  $P_{3(b-1)} : v_1 v_2 \dots v_{3(b-1)}$ . Make all the vertices of  $P_{3(b-1)}$  adjacent to the center vertex of  $W_5$ . Also, make one end vertex of  $P_{3(b-1)}$  adjacent to any one of the outer vertices of

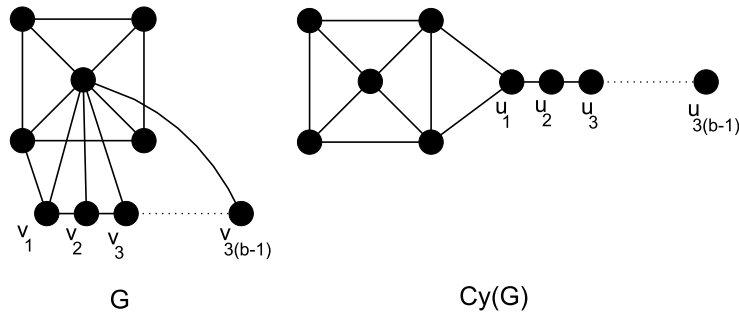

Fig 3.8:  $a = 1$  and  $b > 1$ 

$W_5$  (Fig: 3.8). Then  $\gamma(G) = 1 = a$  and  $\gamma(\text{Cy}(G)) = b$ .

**Case 3.**  $a > 1$ .

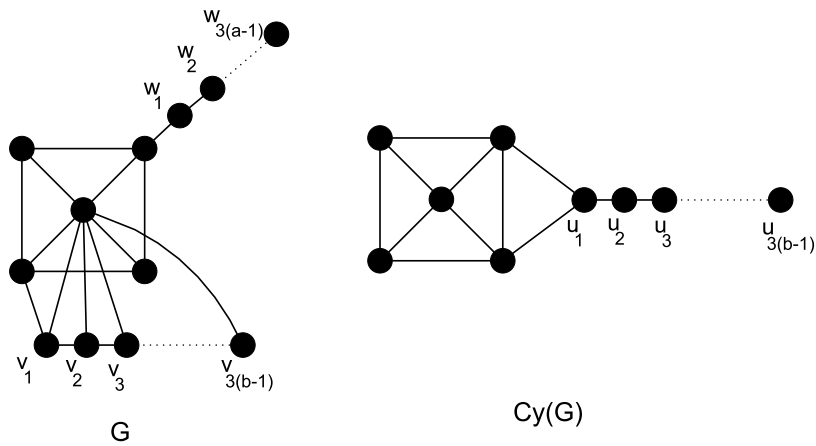
Fig 3.9:  $a > 1$ 

Attach a path  $P_{3(a-1)} : w_1 w_2 \dots w_{3(a-1)}$  to the graph constructed in Case 2 (Fig: 3.9). Then,  $\gamma(G) = a$  and  $\gamma(\text{Cy}(G)) = b$ .

□

**Theorem 3.4.2.** *For any two integers  $a \geq 1, b \geq 0$ , there are graphs  $G$ , such that  $r(G) = a$  and  $r(\text{Cy}(G)) = b$ , where  $r(G)$  is the radius of  $G$ .*

*Proof.*

**Case 1.**  $a = 1$  and  $b = 0$ .

Take  $G$  to be  $K_3$ . Then  $r(G) = r(K_3) = 1 = a$  and  $r(\text{Cy}(G)) = r(K_1) = 0 = b$ .

**Case 2.**  $a = 1$  and  $b > 0$ .

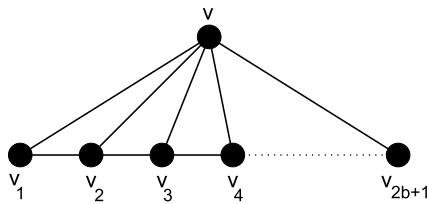

Fig 3.10:  $a = 1$  and  $b > 0$

Take  $G$  to be  $K_1 \vee P_{2b+1}$  where  $v$  is any vertex (Fig: 3.10). Then  $G$  will contain  $2b$  induced cycles each of which is edge intersecting with at most two others. Therefore,  $\text{Cy}(G) \cong P_{2b}$ . Now,  $G$  has a universal vertex  $v$ . Hence,  $r(G) = 1 = a$  and  $r(\text{Cy}(G)) = r(P_{2b}) = b$ .

**Case 3.**  $a > 1$  and  $b = 0$ .

Take  $G$  to be  $C_{2a}$ . Then  $r(G) = r(C_{2a}) = a$  and  $r(\text{Cy}(G)) = r(K_1) = 0 = b$ .

**Case 4.**  $a > 1$  and  $b > 0$ .

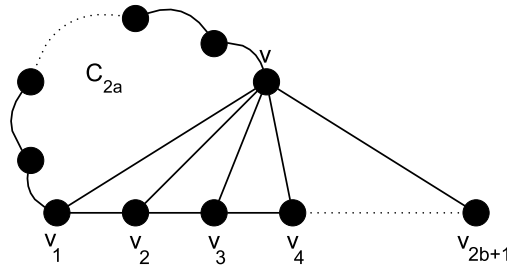

Fig 3.11:  $a > 1$  and  $b > 0$

$G$  can be constructed as follows. Consider the path  $P_{2b}: v_1 v_2 \dots v_{2b}$ . Take  $K_1 \vee P_{2b}$ . Draw a cycle of length  $2a$  with  $vv_1$  as one edge (Fig: 3.11). Then  $\text{Cy}(G) \cong P_{2b}$ . Also  $r(G) = a$  and  $r(\text{Cy}(G)) = r(P_{2b}) = b$ .  $\square$

**Theorem 3.4.3.** *For any two integers  $a > 1, b \geq 0$ , there are graphs  $G$ , such that  $d(G) = a$  and  $d(\text{Cy}(G)) = b$ , where  $d(G)$  is the diameter of  $G$ .*

*Proof.*

**Case 1.**  $b = 0$ .

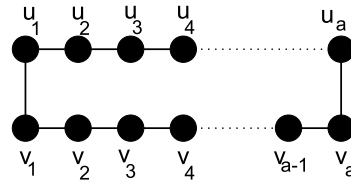

Fig 3.12:  $a > 1$  and  $b > 0$

Take  $G$  as  $C_{2a} : u_1u_2\dots u_av_av_{a-1}\dots v_1$  (Fig: 3.12). Now,  $d(G) = d(C_{2a}) = a$  and  $d(\text{Cy}(G)) = d(K_1) = 0$ .

**Case 2.**  $b = 1, 2, 3, \dots, 2a - 3$ .

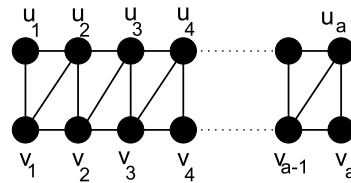

Fig 3.13:  $b \leq 2a - 3$

For  $b = 1, 2, 3, \dots, 2a - 3$ , construct  $G_b$  from the graph  $G$  in Case 1, by adding the edges  $v_1u_2, u_2v_2, v_2u_3, u_3v_3, \dots, v_{a-1}u_a$  successively (Fig: 3.13). At each step we get a graph  $G_b$  such that  $\text{Cy}(G_b)$  is isomorphic to  $P_{b+1}$  whose diameter is  $b$ . Also,

note that throughout the construction the distance between  $u_1$  and  $v_a$  is  $a$ . Therefore,  $d(G_b) = a$ .

**Case 3.**  $b = 2a - 2$ .

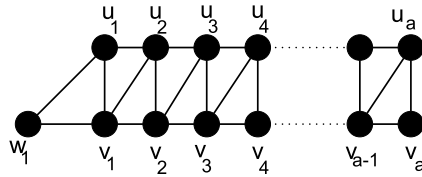

Fig 3.14:  $b = 2a - 2$

Add a new vertex  $w_1$  to the graph  $G_{2a-3}$  constructed in Case 2 and make it adjacent to  $u_1$  and  $v_1$  (Fig: 3.14). This graph will have  $2a - 1$  induced cycles and  $\text{Cy}(G) \cong P_{2a-1}$ . Therefore,  $d(\text{Cy}(G)) = d(P_{2a-1}) = 2a - 2 = b$ . Also, the distance between  $u_1$  and  $v_a$  is  $a$  and distance between  $w_1$  and  $v_a$  is also equal to  $a$ . All the other vertices have lesser eccentricity. Hence,  $d(G) = a$ .

**Case 4.**  $b > 2a - 2$ .

Let  $m = b - (2a - 2)$ . To the graph constructed in Case 3 add  $m$  vertices  $w_2, w_3, \dots, w_{m+1}$ . Make all these vertices adjacent to  $v_1$ . Also make  $w_i$  adjacent to  $w_{i-1}$  for  $i = 2, 3, \dots, m+1$  (Fig: 3.15). This will produce a graph with  $b + 1$  induced cycles. Therefore

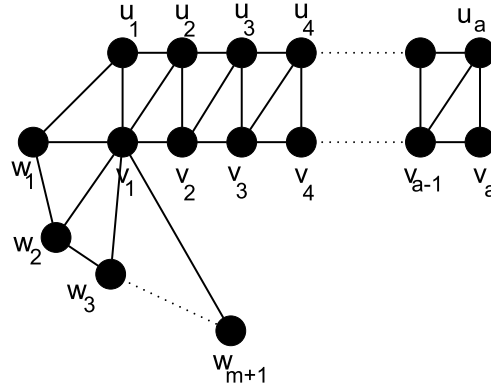

Fig 3.15:  $b > 2a - 2$

$Cy(G) \cong P_{b+1}$  and  $d(Cy(G)) = d(P_{b+1}) = b$ . Also, all the vertices  $w_i$  have eccentricity  $a$ . Therefore,  $d(Cy(G)) = a$ .  $\square$

The Case  $a = 1$  in the above theorem is as follows.

**Remark 3.4.1.** Let  $G$  be a graph such that  $d(G) = 1$ , then  $d(Cy(G)) \leq 3$ .

*Proof.* Let  $d(G) = 1$ . Then  $G$  is a complete graph. In a complete graph all induced cycles are triangles which can occur in three ways.

**Case 1:**

Two triangles have a common edge. Then, the corresponding

vertices in the cycle graph are adjacent. Hence, the distance between them is one.

**Case 2:**

Two triangles have a common vertex. If one vertex is common to two triangles  $T_1$  and  $T_2$ , then there exists another triangle  $T_3$  which is adjacent to both. Therefore, in the cycle graph the distance between  $T_1$  and  $T_2$  is two.

**Case 3:**

Two triangles are disjoint . If no vertex is common to two triangles  $T_1$  and  $T_2$  then there exists two other triangles  $T_3$  and  $T_4$  such that  $T_1$  is edge intersecting with  $T_3$ ;  $T_3$  is edge intersecting with  $T_4$  and  $T_4$  is edge intersecting with  $T_2$ . Therefore, distance between  $T_1$  and  $T_2$  in the cycle graph is three.

Therefore, the maximum distance between any two vertices in the cycle graph of a complete graph is three.  $\square$

**Remark 3.4.2.** The diameter of  $\text{Cy}(K_3)$ ,  $\text{Cy}(K_4)$  ,  $\text{Cy}(K_5)$  and  $\text{Cy}(K_6)$  is zero, one, two and three respectively.

## 3.5 Solution of a graph equation

Problems of the following type which lead to some graph equations have been studied by various authors as detailed in [59].

In this section we attempt such a problem on cycle graphs.

**Problem:** Let  $G_1$  and  $G_2$  be graphs,  $*$  a binary graph operation and  $\Phi$  a graph operator. What conditions can be imposed on  $G_1$  and  $G_2$  such that  $\Phi(G_1 * G_2)$  is isomorphic to some graph resulting from graph operations on  $G_1$  and  $G_2$ ?

**Theorem 3.5.1.**  $Cy(G \square K_2) \cong L(G)$  if and only if  $G$  is a forest.

*Proof.* Let  $G$  be a forest. Then, all the induced cycles of  $G \square K_2$  are 4-cycles. Also, there is a one-to-one correspondence between the edges of  $G$  and the induced cycles in  $G \square K_2$ . Whenever two edges are adjacent in  $G$ , the corresponding 4-cycles in  $G \square K_2$  are edge intersecting. Therefore, the cycle graph of  $G \square K_2$  is isomorphic to  $L(G)$ .



Conversely, let the cycle graph of  $G \square K_2$  be isomorphic to  $L(G)$ . If possible let  $G$  be not a forest. Then  $G$  contain some cycle.  $G \square K_2$  has a 4-cycle corresponding to each edge of  $G$ . The induced cycles of  $G$  will be induced cycles of  $G \square K_2$  also. Therefore, the number of induced cycles of  $G \square K_2$  is greater than the number of edges of  $G$ , which is a contradiction.

□

# Chapter 4

## Power domination in grid graphs

In this chapter we focus on the power domination problem which is a variant of the domination problem. We obtain the power domination number of hexagonal honeycomb grid graph and triangular grid graph.

---

Some results of this chapter are included in the following paper.

1. D. Ferrero, Seema Varghese, A. Vijayakumar, Power domination in honeycomb networks, *Journal of Discrete Mathematical Sciences and Cryptography*, (to appear).

## 4.1 Hexagonal grids

It is clear from Definition 1.1.36 that  $HM_1$  is one simple hexagon. Then, the hexagonal honeycomb grid of dimension two,  $HM_2$ , is obtained by adding six hexagons to the boundary edges of  $HM_1$ . In general, the hexagonal honeycomb grid of dimension  $n$ ,  $HM_n$ , is obtained by adding a layer of hexagons around the boundary of  $HM_{n-1}$ . The number of layers of hexagons between  $HM_1$  and the border of  $HM_n$  is called its dimension  $n$ . Fig: 1.14 shows the labeled version of the graph  $HM_3$ . Note that  $HM_n$  is a bipartite graph. We denote by  $V_1$  and  $V_2$  its partite sets where  $V_1 = \{(x, y, z) \mid x, y, z \in [-n + 1, n] \text{ and } x + y + z = 1\}$  and  $V_2 = \{(x, y, z) \mid x, y, z \in [-n + 1, n] \text{ and } x + y + z = 2\}$ . Also, note that there are  $2n$   $X$ -diagonals,  $Y$ -diagonals and  $Z$ -diagonals each in  $HM_n$ . The order of  $HM_n$  is  $6n^2$ .

In order to determine the power domination number of a hexagonal honeycomb grid we use the following version of power domination introduced in [27].

**Definition 4.1.1.** For a graph  $G$  and a set  $T \subseteq V(G)$ , the *closure* of  $T$  in  $G$  is denoted by  $C_G(T)$  is recursively defined as follows: Start with  $C_G(T) = T$ . As long as exactly one of the neighbors of some element of  $C_G(T)$  is not in  $C_G(T)$ , add that neighbor to  $C_G(T)$ .

**Definition 4.1.2.** For a graph  $G$  and a set  $T \subseteq V(G)$ , the *star closure* of  $T$  in  $G$  is denoted by  $C_G^*(T)$  is recursively defined as follows: Start with  $C_G^*(T) = T$ . As long as exactly one of the neighbors of some vertex of  $G$  is not in  $C_G^*(T)$ , add that neighbor to  $C_G^*(T)$ .

If the graph  $G$  is clear from the context, we simply write  $C(T)$  and  $C^*(T)$  rather than  $C_G(T)$  and  $C_G^*(T)$ . Note that  $M(S) = C(N[S])$ . In particular, if  $S \in V$  is power dominating set of  $G$ , then  $C(N[S]) = V$ . Further, if  $S$  power dominates  $G$  and if  $T$  is obtained from  $S$  by adding all but one neighbor of every vertex in  $S$  then  $C(T) = V$ . Fig: 4.1 shows a set  $T = \{(-1, 1, 1), (0, 0, 1)\}$  in  $\text{HM}_3$  and the corresponding set  $C^*(T) = T \cup \{(0, 1, 0)\}$ .

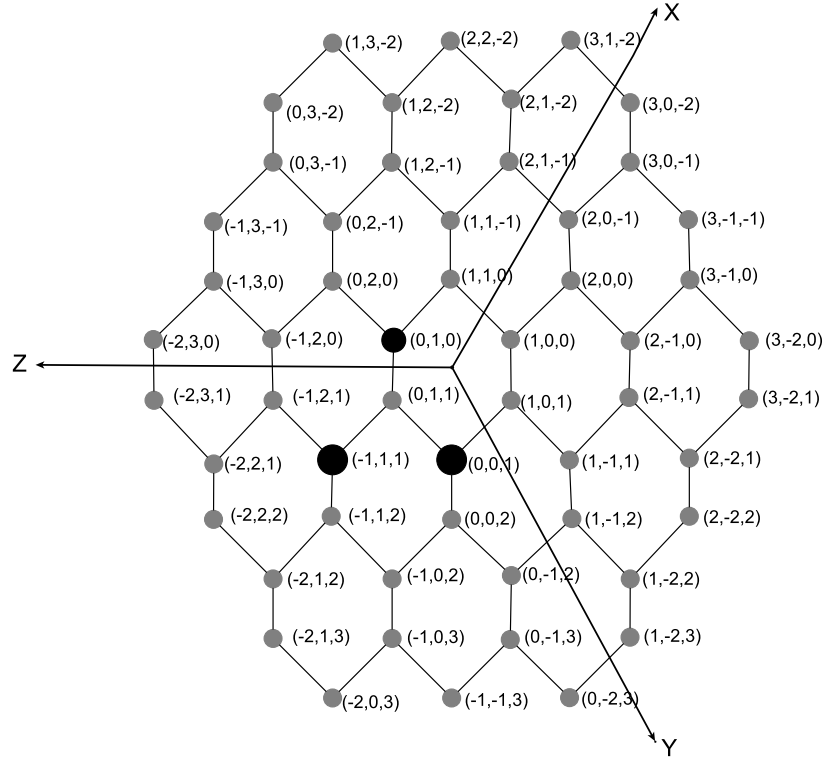
Fig 4.1:  $C^*(T)$  for  $HM_3$ 

**Lemma 4.1.1.** *If  $G = HM_n$ , then  $\gamma_P(G) \leq \lceil \frac{2n}{3} \rceil$ .*

*Proof.* We consider the three possibilities and give a power dominating set  $S$  of order  $\lceil \frac{2n}{3} \rceil$  for each case.

(i)  $n = 3k$ :

$$S = \{\cup_{i=1}^k (0, 3i, 2 - 3i)\} \cup \{\cup_{i=1}^k (0, 3i - 2, 3 - 3i)\}.$$

In this case,  $|S| = 2k$ . Also,  $\lceil \frac{2n}{3} \rceil = \lceil \frac{2(3k)}{3} \rceil = 2k$ .

(ii)  $n = 3k + 1$ :

$$S = \{\cup_{i=1}^{k+1} (0, 3i - 2, 4 - 3i)\} \cup \{\cup_{i=1}^k (0, 3i - 1, 2 - 3i)\}.$$

Here,  $|S| = 2k + 1$ . Also,  $\lceil \frac{2n}{3} \rceil = \lceil \frac{2(3k+1)}{3} \rceil = 2k + 1$ .

(iii)  $n = 3k + 2$

$$S = \{\cup_{i=1}^{k+1} (0, 3i - 1, 3 - 3i)\} \cup \{\cup_{i=1}^k (0, 3i - 3, 4 - 3i)\}.$$

In this case,  $|S| = 2k + 2$ . Also,  $\lceil \frac{2n}{3} \rceil = \lceil \frac{2(3k+2)}{3} \rceil = 2k + 2$ .

In each case, all the vertices are monitored either by direct domination or by propagation. Thus,  $M(S) = V(G)$  and hence  $S$  is a power dominating set.  $\square$

An illustration of a power dominating set for  $HM_3$  is given in Fig: 4.2.

**Lemma 4.1.2.** *Let  $G = HM_n$ . If  $T \subseteq V_1$  and  $|T| < 2n$ , then  $C^*(T)$  covers at most  $|T|$  diagonals.*

*Proof.* Let  $G'$  be the graph with vertex set  $V(G') = V(G)$  where  $uv \in E(G')$  if and only if  $d_G(u, v) = 2$ . For disjoint subsets  $U_1, U_2 \subseteq V_1$ , if no vertex of  $C_G^*(U_1)$  is adjacent in  $G'$  to any

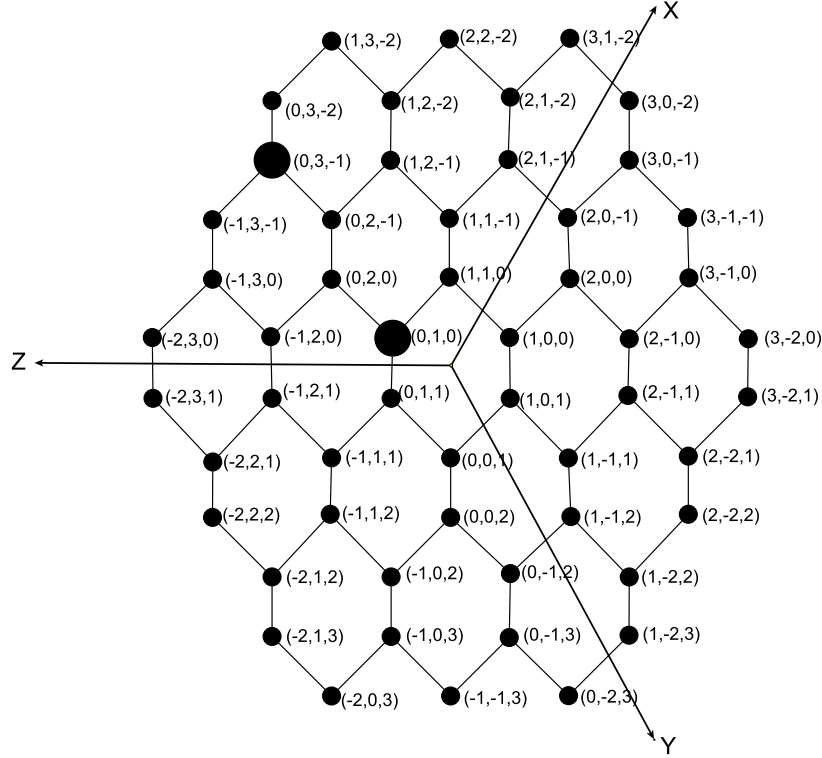

Fig 4.2: The set  $\{(0, 3, -1), (0, 1, 0)\}$  is a power dominating set for  $\text{HM}_3$ .

vertex of  $C_G^*(U_2)$ , then  $C_G^*(U_1 \cup U_2) = C_G^*(U_1) \cup C_G^*(U_2)$ . We may therefore assume that  $C_G^*(T)$  is connected in  $G'$ . Now, we shall prove the statement by induction on  $|T|$ . If  $|T| = 1$ , the result clearly holds. Now, let us consider  $T \subseteq V_1$  with  $|T| > 1$ . We can assume  $C_G^*(T)$  is connected in  $G'$ . Also, since the number of  $X$ ,  $Y$  or  $Z$ -diagonals in  $\text{HM}_n$  is exactly  $2n$ , we can assume  $|T| < 2n$ .

By inductive hypothesis, the result holds for all  $T' \subset T$ . In particular, it holds for a maximal proper subset  $T' \subset T$  such that  $C_G^*(T')$  is connected in  $G'$ . Since  $C_G^*(T)$  is connected, some vertex of  $C_G^*(T')$  is adjacent in  $G'$  to some vertex of  $C_G^*(T \setminus T')$ . By maximality of  $T'$ ,  $C_G^*(T \setminus T')$  is connected. Since the inductive hypothesis also applies to  $T \setminus T'$ , we have the following:

- (1) The number of diagonals covered by  $C_G^*(T') \leq |T'|$ .
- (2) The number of diagonals covered by  $C_G^*(T \setminus T') \leq |T \setminus T'|$ .

Therefore, from (1) and (2) we conclude that the number of diagonals covered by  $C_G^*(T) = C_G^*(T') \cup C_G^*(T \setminus T')$  is at most  $|T'| + |T \setminus T'| = |T|$ .  $\square$

**Lemma 4.1.3.** *If  $G = HM_n$ , then  $\gamma_P(G) \geq \lceil \frac{2n}{3} \rceil$ .*

*Proof.* Let  $G = HM_n$  and let  $S \subseteq V(G)$  be a power dominating set of  $G$ . Let  $T$  be obtained from  $S$  by adding the neighbors of every vertex in  $S$  that is  $T = N[S]$ . Since  $S$  is a power dominating set of  $G$ , then  $C_G(T) = V(G)$ . Notice that in a bipartite graph  $H$  with partite sets  $H_1$  and  $H_2$ ,  $C_H(W) \cap H_1 \subseteq C_H((W \cap H_1) \cup H_2) \cap H_1 = C_H^*(W \cap H_1)$ , for any  $W \subseteq V(H)$ . Thus we have,  $C_G(T) \cap V_1 \subseteq C_G((T \cap V_1) \cup V_2) \cap V_1 = C_G^*(T \cap V_1)$  and therefore  $C_G^*(T \cap V_1)$  covers all diagonals. Hence it follows



from Lemma 4.1.2 that  $|T \cap V_1| \geq 2n$  which implies  $|T| \geq 2n$ . For any  $v \in G$ , we have  $\deg(v) \leq 3$  and so  $|T| \leq 3|S|$ . Thus we have,  $3|S| \geq |T| \geq 2n$  and  $|S| \geq \frac{2n}{3}$ .  $\square$

**Theorem 4.1.4.** *If  $G = HM_n$ , then  $\gamma_P(G) = \lceil \frac{2n}{3} \rceil$ .*

*Proof.* Follows from Lemmas 4.1.1, 4.1.2 and 4.1.3.  $\square$

## 4.2 Triangular grids

In this section we compute the power domination number of the triangular grid graph  $T_n$ . It is clear from Definition 1.1.37 that  $T_1$  is a triangle. Then,  $T_2$  is obtained from  $T_1$  by adjoining three edge intersecting triangles to its bottom boundary. In general, the graph  $T_n, n > 2$  is obtained by adjoining  $2n + 1$  edge intersecting triangles to the bottom boundary of  $T_{n-1}$ . The number of layers of triangles in  $T_n$  (Fig: 1.15) is called its dimension  $n$ . The order of  $T_n$  is  $\frac{(n+1)(n+2)}{2}$ .

**Lemma 4.2.1.** *If  $G = T_n$ , then  $\gamma_p(G) \leq \lceil \frac{n+1}{4} \rceil$ .*

*Proof.* Consider the set  $S$  defined as follows.

(i) If  $n = 1$ :

$$S = \{(0, 1, 0)\}.$$

(ii) If  $n = 2$ :

$$S = \{(0, 1, 1)\}.$$

(iii) If  $n = 3$ :

$$S = \{(1, 1, 1)\}.$$

In each of the above cases,  $|S| = 1$  and  $\lceil \frac{n+1}{4} \rceil = 1$ .

(iv) If  $n = 4k$ :

$$S = \{\cup_{i=1}^k (n - (4i - 2), 1, 4i - 3) \cup (0, 1, n - 1)\}.$$

In this case,  $|S| = k + 1$  and  $\lceil \frac{n+1}{4} \rceil = \lceil \frac{4k+1}{4} \rceil = k + 1$ .

(v) If  $n = 4k + 1$ :

$$S = \{\cup_{i=1}^k (n - (4i - 2), 1, 4i - 3) \cup (0, 1, n - 1)\}.$$

Here,  $|S| = k + 1$  and  $\lceil \frac{n+1}{4} \rceil = \lceil \frac{4k+2}{4} \rceil = k + 1$ .

(vi) If  $n = 4k + 2$ :

$$S = \{\cup_{i=1}^k (n - (4i - 2), 1, 4i - 3) \cup (0, 1, n - 1)\}.$$

Here,  $|S| = k + 1$  and  $\lceil \frac{n+1}{4} \rceil = \lceil \frac{4k+3}{4} \rceil = k + 1$ .

(vii) If  $n = 4k + 3$ :

$$S = \{\cup_{i=1}^k (n - (4i - 2), 1, 4i - 3) \cup (1, 1, n - 2)\}.$$

Here,  $|S| = k + 1$  and  $\lceil \frac{n+1}{4} \rceil = \lceil \frac{4k+4}{4} \rceil = k + 1$ .

In each case, all the vertices are monitored either by direct domination or by propagation. Thus  $M(S) = V(G)$  and hence  $S$  is a power dominating set of cardinality  $\lceil \frac{n+1}{4} \rceil$  (Fig 4.3).  $\square$

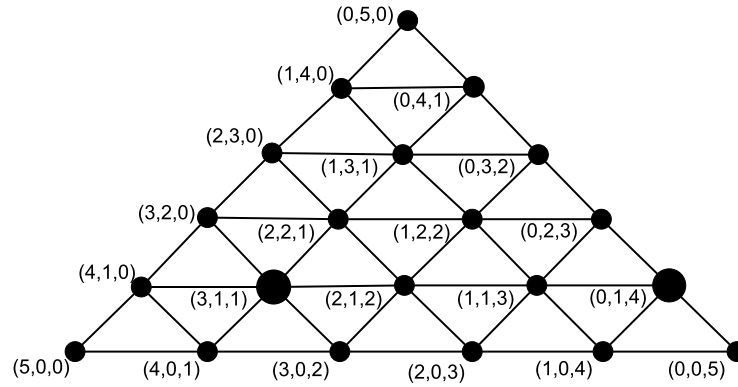

Fig 4.3: The set  $\{(3, 1, 1), (0, 1, 4)\}$  is a power dominating set in  $T_5$ .

**Lemma 4.2.2.** *Let  $G = T_n$ . If  $S \subseteq G$  and  $|S| < \frac{n+1}{4}$ , then  $M(S)$  covers at most  $4|S|$  diagonals, where  $|S|$  is the cardinality of  $S$ .*

*Proof.* Let  $G'$  be the graph with  $V(G') = V(G)$  and  $uv \in E(G')$  if and only if  $d_G(u, v) = 2$  and  $u$  and  $v$  do not cover a common diagonal or  $d_G(u, v) = 2$  and  $u$  and  $v$  cover a common boundary. It is clear that, for disjoint subsets  $S_1, S_2 \subseteq G$ , if no vertex of  $N(S_1)$  is adjacent in  $G'$  to any vertex of  $N(S_2)$ , then

$M(S_1 \cup S_2) = M(S_1) \cup M(S_2)$ . We may, therefore, assume that  $M(S)$  is connected in  $G'$ . If  $|S| = 1$ , then it is clear that  $M(S)$  can cover at most three diagonals. Let  $S \subseteq G$  with  $M(S)$  connected in  $G'$  and  $|S| < \frac{n+1}{4}$ . Assume the result for all  $S' \subset S$ . Consider a maximal proper subset  $S' \subset S$  such that  $M(S')$  is connected in  $G'$ . Now, since  $M(S)$  is connected in  $G'$ , some vertex of  $M(S')$  is adjacent in  $G'$  to some vertex of  $M(S \setminus S')$ . By maximality of  $S'$ ,  $M(S \setminus S')$  is connected. Since the inductive hypothesis also applies to  $S \setminus S'$ , we have the following:

- (1) The number of diagonals covered by  $M(S') \leq 4|S'|$ .
- (2) The number of diagonals covered by  $M(S \setminus S') \leq 4|S \setminus S'|$ .

Therefore, from (1) and (2) we conclude that the number of diagonals covered by  $M(S) = M(S') \cup M(S \setminus S')$  is at most  $4|S'| + 4|S \setminus S'| = 4|S|$ .  $\square$

**Lemma 4.2.3.** *If  $G = T_n$ , then  $\gamma_p(G) \geq \lceil \frac{n+1}{4} \rceil$ .*

*Proof.* By Lemma 4.2.2, if  $S \subseteq G$  is such that  $|S| < \frac{n+1}{4}$ , then  $M(S)$  covers at most  $n$  diagonals. But there are  $n + 1$  diagonals in  $T_n$  and hence  $\gamma_p(G) \geq \lceil \frac{n+1}{4} \rceil$ .  $\square$

**Theorem 4.2.4.** *If  $G = T_n$ , then  $\gamma_p(G) = \lceil \frac{n+1}{4} \rceil$ .*

*Proof.* Follows from Lemmas 4.2.1, 4.2.2 and 4.2.3.  $\square$

Now, we extend the Theorem 4.2.4 to rectangular triangular grid (Definition 1.1.38).

**Theorem 4.2.5.** *If  $G = RT_{m,n}$ , then  $\gamma_p(G) = \lceil \frac{m+1}{4} \rceil$ .*

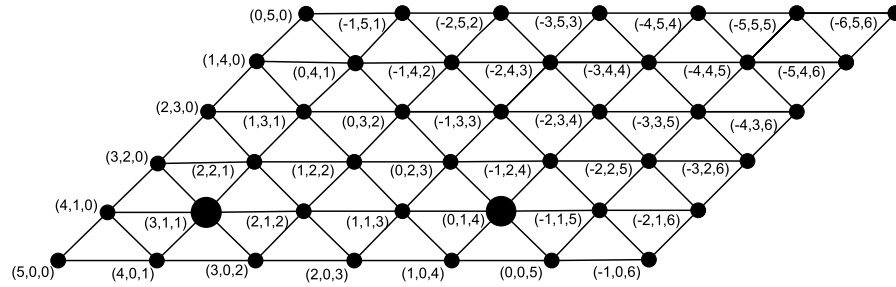

Fig 4.4: The set  $\{(3, 1, 1), (0, 1, 4), \}$  is a power dominating set in  $RT_{5,6}$

*Proof.* Note that, in order to power dominate the whole graph, we need to power dominate either all the I-diagonals, all the J-diagonals or all the K-diagonals. In  $G = RT_{m,n}$ , the number of I-diagonals, J-diagonals and K-diagonals are  $m + n + 1, m + 1$  and  $n + 1$  respectively. Since the number of J-diagonals is the least, it is desirable to power dominate all the J-diagonals, for which we need at least  $\lceil \frac{m+1}{4} \rceil$  vertices (Fig 4.4). The proof follows as in Lemma 4.2.2.  $\square$

# Chapter 5

## Power domination in some classes of graphs

The power domination problem in some classes of graphs such as Mycielskians, direct products, Cartesian product etc. are discussed in this chapter.

---

Some results of this chapter are included in the following papers.

1. Seema Varghese, A. Vijayakumar, Power domination in triangular grids and Mycielskian of graphs (Submitted).

## 5.1 Mycielskian of graphs

In this section we shall investigate the power domination number of the Mycielskian of a graph. It is proved in [30] that,  $\gamma(\mu(G)) = \gamma(G) + 1$ . But, we only have that,  $\gamma_p(\mu(G)) \leq \gamma_p(G) + 1$ . The upper bound is attained for  $G \cong C_n; n \geq 4$ . We shall obtain a sufficient condition which improves the bound for  $\gamma_p(\mu(G))$ , using the following concepts introduced in [51].

Let  $H$  be an induced subgraph of  $G$ . The **out-degree** of  $v \in H$  is the number of vertices in  $G \setminus H$  adjacent to  $v$  and the edge  $vw$  connecting a vertex  $v \in H$  and  $w \notin H$  is called an **outgoing edge**. A set  $S_0 \subseteq V(G)$  is referred to as the **kernel**. The set of vertices which are directly dominated by  $S_0$  form the **first generation descendants** or **1-descendants**, denoted by  $S_1$  and the subgraph induced by  $S_0 \cup S_1$  is called the **derived kernel of first generation**. The  **$i$ th generation descendants** or  **$i$ -descendants**,  $S_i$  are those vertices which are monitored by propagation from  $S_{i-1}$ .

**Theorem 5.1.1.** *If  $G$  has a minimum power dominating set in which every vertex has a neighbor of outdegree one in  $S_1$ , then  $\gamma_p(\mu(G)) \leq \gamma_p(G)$ .*

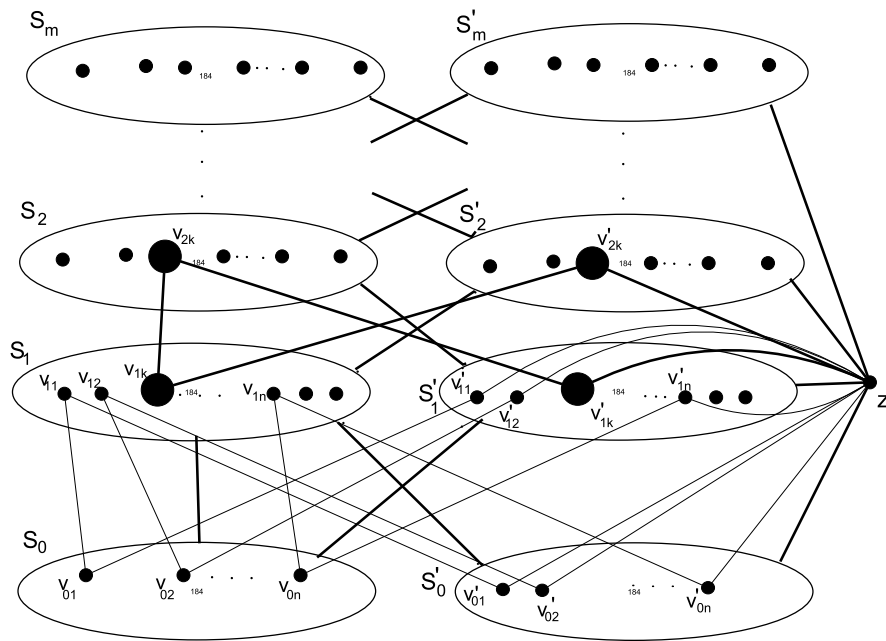

Fig 5.1: An illustration of the proof

*Proof.* Let  $\gamma_p(G) = n$  and  $S_0 = \{v_{01}, v_{02}, \dots, v_{0n}\}$  be a minimum power dominating set of  $G$  with  $\{v_{11}, v_{12}, \dots, v_{1n}\}$  as the corresponding neighbors of out-degree one in  $S_1$  (Fig 5.1). We shall prove that  $S_0$  is a power dominating set for  $\mu(G)$  also.



The set  $N[S_0] = S_1 \cup S'_1$  is monitored by  $S_0$ . Each vertex of  $\{v_{11}, v_{12}, \dots, v_{1n}\}$  has a single unmonitored neighbor which is in  $S'_0$  and hence  $S'_0$  is monitored by propagation. Any vertex of  $S'_0$  has only one unmonitored neighbor,  $z$ , the root of  $\mu(G)$  and thus it is monitored by propagation from  $S'_0$ . For each vertex  $v_{2k}$  of  $S_2$ , there exists predecessor  $v_{1k}$  in  $S_1$  from which it is monitored by propagation. This vertex  $v_{1k}$  in  $S_1$  has exactly one out-neighbor  $v_{2k}$  which is in  $S_2$ . The twin vertex  $v'_{1k}$  has all its neighbors monitored except  $v_{2k}$  and hence it is monitored by propagation from  $v'_{1k}$ . Now,  $v'_{2k}$  is the only one unmonitored neighbor of  $v_{1k}$  in  $\mu(G)$  and thus it is also monitored by propagation from  $v_{1k}$ . By repetition of this process, we can monitor all the vertices of  $S_2 \cup S'_2$ . Similarly, by propagation, all the vertices of  $S_l$  and  $S'_l$  are monitored for any  $l \geq 2$ . Hence,  $S_0$  is a power dominating set for  $\mu(G)$  also.  $\square$

**Theorem 5.1.2.** *Let  $V(\mu(G)) = V \cup V' \cup \{z\}$  and  $S'_0 \subseteq V'$ . If  $S'_0$  is a power dominating set of  $\mu(G)$ , then the set of its twin vertices  $S_0 \subseteq V$  is also a power dominating set of  $\mu(G)$ .*

*Proof.* Let  $v \in V$  and  $v' \in V'$  be twin vertices in  $\mu(G)$ . Then,  $N_{\mu(G)}(v') = N_G(v) \cup \{z\}$ . Hence all the vertices monitored

by  $v'$  is also monitored by  $v$  except possibly the root vertex  $z$ . Thus, all the vertices monitored by  $S'_0 \subseteq V'$  is also monitored by  $S_0 \subseteq V$  except possibly the root vertex  $z$ , which can be monitored by propagation.  $\square$

**Theorem 5.1.3.** *Let  $G$  be a connected graph with  $\gamma_p(\mu(G)) \leq \gamma_p(G)$  and  $\gamma_p(\mu(G)) \neq 1$ . Then  $\gamma_p(\mu(G)) = \gamma_p(G)$ .*

*Proof.* There are four possibilities for a power dominating set  $S$  of  $\mu(G)$ .

(1)  $S \subseteq V$ , (2)  $S \subseteq V \cup \{z\}$ , (3)  $S \subseteq V'$ , (4)  $S \subseteq V \cup V'$ .

If  $S \subseteq V$ , with  $|S| < \gamma_p(G)$  is a power dominating set for  $\mu(G)$ , then clearly it is a power dominating set for  $G$  also, which is a contradiction. If  $S \subseteq V \cup \{z\}$  with  $|S \cup \{z\}| < \gamma_p(G)$ , then  $M(S) \subset G$  and the vertices of  $G \setminus M(S)$  should be power dominated by propagation from  $z$  through the twin vertices. Hence, no vertex of  $G \setminus M(S)$  can be adjacent to any vertex of  $M(S)$  which means that  $G$  is disconnected. If  $S \subseteq V'$ , then by Theorem 5.1.2, its twin set in  $V$  will form a power dominating set for  $\mu(G)$ . The set  $(S \cap V) \cup \{z\}$  will dominate all the vertices dominated by the set  $S \cap V'$ . Hence the possibility  $S \subseteq V \cup V'$  can be replaced by the case  $S \subseteq V \cup \{z\}$ .  $\square$

**Corollary 5.1.4.** If  $G$  is a connected graph, then

$$\gamma_p(\mu(G)) \in \{1, \gamma_G, \gamma_p(G) + 1\}.$$

**Theorem 5.1.5.** If  $G$  has a universal vertex then  $\gamma_p(\mu(G)) = 1$ .

*Proof.* Let  $u_0$  be the universal vertex of  $G$  and  $N(u_0) = \{u_1, u_2 \dots u_n\}$ . Let  $[N(u_0)]' = \{u'_1, u'_2 \dots u'_n\}$  be the set of corresponding twin vertices and  $z$  be the root in  $\mu(G)$ . Then, in  $\mu(G)$ ,  $N[u_0] = \{u_0, u_1, u_2 \dots u_n, u'_1, u'_2 \dots u'_n\}$ . Thus, all the vertices of  $\mu(G)$  except  $u'_0$  and  $z$  are monitored by  $u_0$ . The vertex  $z$  is monitored by propagation from  $u'_1$  and  $u'_0$  is monitored by propagation from  $u_1$ . Hence,  $\{u_0\}$  is a power dominating set for  $\mu(G)$  and  $\gamma_p(\mu(G)) = 1$ .  $\square$

It follows that the power domination number of the Mycielskian of the complete graph, the wheel, the  $n$ -fan and the  $n$ -star is equal to one. If  $P_n$  is the path  $\langle v_1 v_2 \dots v_n \rangle$ , then  $v_2$  is a power dominating set for  $\mu(P_n)$ . Hence,  $\gamma_p(\mu(P_n)) = 1$  and so the condition of Theorem 5.1.5 is not necessary. In the following theorem, we show that the difference between  $\gamma_p(G)$  and  $\gamma_p(\mu(G))$  can be arbitrarily large.

**Theorem 5.1.6.** For every  $n \geq 1$ , there are graphs with  $\gamma_p(G) =$

$n$  and  $\gamma_p(\mu(G)) = 1$ .

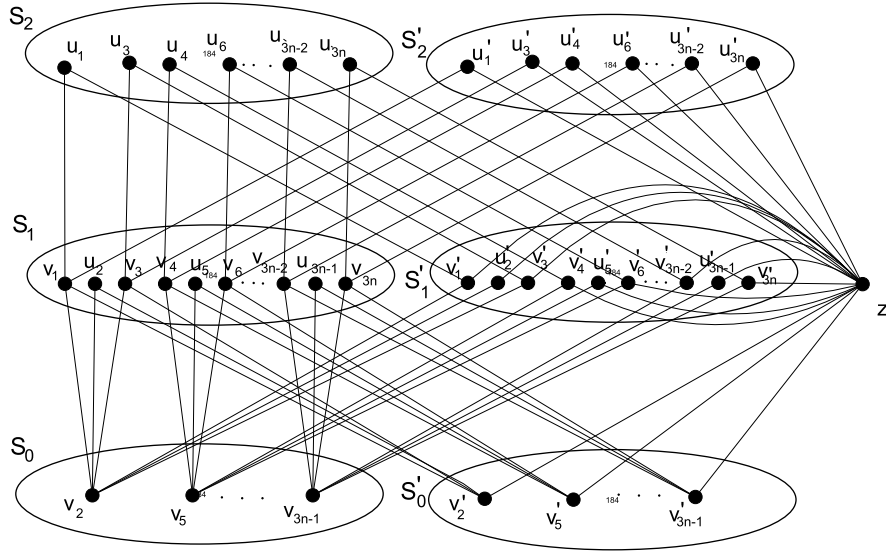

Fig 5.2:  $\mu(\text{Caterpillar})$

*Proof.* For  $n \geq 1$ , let  $G$  be the caterpillar obtained by attaching pendant vertices  $\{u_1, u_2, \dots, u_{3n}\}$  to each vertex  $\{v_1, v_2, \dots, v_{3n}\}$  of a path  $P_{3n}$ . Clearly,  $S_0 = \{v_2, v_5, \dots, v_{3n-1}\}$  is a power dominating set for  $G$  and any  $S \subseteq V(G)$ , with  $|S| < n$  is not a power dominating set. Hence  $\gamma_p(G) = n$ . Now, we shall show that  $\{z\}$  will form a power dominating set for  $\mu(G)$ . Let the vertices of  $\mu(G)$  be labeled as in Fig 5.2.  $S_1, S_2$  be the set of 1st and 2nd generation descendants respectively.  $S'_0, S'_1, S'_2$

be the sets of corresponding twin vertices. All the vertices of  $N[z] = S'_0 \cup S'_1 \cup S'_2 \cup \{z\}$  are monitored by the vertex  $z$ . The vertices of  $S_2$  are of degree one in  $G$  and hence their twin vertices in  $S'_2$  are of degree two in  $\mu(G)$ . All of them have the root vertex  $z$  as a neighbor which is already monitored. Thus all their neighbors in  $S_1$ , which are precisely the vertices of  $S_1$  with degree greater than one in  $G$ , are monitored by propagation from  $S'_2$ . Now, the vertices of  $S_1$  which are left unmonitored are the pendant neighbors of each vertex of  $S_0$  in  $G$ . Since there is exactly one pendant vertex attached to a vertex of  $S_0$ , each vertex of  $S'_0$  has exactly one unmonitored neighbor in  $S_1$  and hence they are monitored by propagation from  $S'_0$ . Next, the pendant vertices attached to each vertex of  $S_0$  are of degree two in  $\mu(G)$  and they have exactly one unmonitored neighbor which is in  $S_0$ . Thus each vertex of  $S_0$  is monitored by propagation from  $S_1$ . Finally, the vertices in  $S_2$  are pendant vertices in  $G$  which are of degree two in  $\mu(G)$  and are monitored either by propagation from  $S_1$  or from  $S'_1$ .  $\square$

**Remark 5.1.1.** There exists family of graphs satisfying the following.

$$(1) \gamma_p(\mu(G)) = \gamma_p(G).$$

$$(2) \gamma_p(\mu(G)) < \gamma_p(G).$$

$$(3) \gamma_p(\mu(G)) > \gamma_p(G).$$

$\gamma_p(\mu(P_n)) = \gamma_p(P_n) = 1$ . The graphs constructed in Theorem 5.1.6 will satisfy (2) and the family of cycles,  $C_n, n \geq 4$ , will satisfy (3).

## 5.2 Generalized Mycielskian of paths

In this section we show that the power domination number of generalized Mycielskian of even path is one and hence they form a suitable structure for electrical networks. We also obtain an upper bound for the power domination number of generalized Mycielskian of odd path.

**Theorem 5.2.1.** *For an even integer  $n$ ,  $\gamma_p(\mu_m(P_n)) = 1$ .*

*Proof.* All vertices in the  $m$ -th twin set are monitored directly by  $z$  and all other vertices are monitored by propagation. Hence, the root vertex  $z$  in  $\mu_m(P_n)$  form a power dominating set (Fig:5.3). □

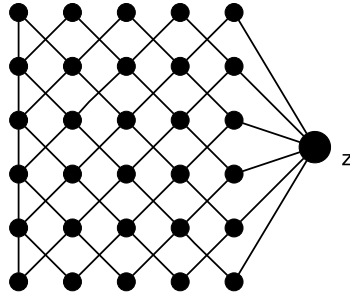

Fig 5.3: The root vertex  $z$  is a power dominating set in  $\mu_4(P_6)$

**Theorem 5.2.2.** For an integer  $m \geq 2$  and an odd integer  $n$ ,

$$\gamma_p(\mu_m(P_n)) \leq \frac{m}{2} + 1, \text{ if } m \text{ is even.}$$

$$\gamma_p(\mu_m(P_n)) \leq \frac{m+1}{2}, \text{ if } m \text{ is odd.}$$

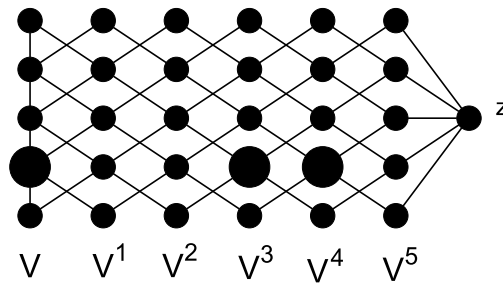

Fig 5.4:  $\{v_2, v_2^3, v_2^4\}$  is a power dominating set in  $\mu_5(P_5)$

*Proof.* Let  $V(\mu_m(P_n)) = V \cup V^1 \cup V^2 \cup \dots \cup V^m \cup \{z\}$ , where  $V = \{v_1, v_2 \dots v_n\}$ ,  $V^i = \{v_1^i, v_2^i \dots v_n^i\}$  for  $i \in \{1, 2, \dots, m\}$ . We consider the different possibilities for  $m$  and a set  $S$  is defined for each case as follows.

(1)  $m = 2$ :

$$S = \{v_2, v_2^1\}$$

(2)  $m = 3$ :

$$S = \{v_2^1, v_2^2\}$$

(3)  $m = 4k$ :

$$S = \{v_2\} \cup \{v_2^2, v_2^6, v_2^{10}, \dots, v_2^{4k-2}\} \cup \{v_2^3, v_2^7, v_2^{11}, \dots, v_2^{4k-1}\}$$

(4)  $m = 4k + 1$ :

$$S = \{v_2\} \cup \{v_2^3, v_2^7, v_2^{11}, \dots, v_2^{4k-1}\} \cup \{v_2^4, v_2^8, v_2^{12}, \dots, v_2^{4k}\}$$

(4)  $m = 4k + 2$ :

$$S = \{v_2\} \cup \{v_2^1\} \cup \{v_2^4, v_2^8, v_2^{12}, \dots, v_2^{4k}\} \cup \{v_2^5, v_2^9, v_2^{13}, \dots, v_2^{4k+1}\}$$

(4)  $m = 4k + 3$ :

$$S = \{v_2^1, v_2^5, v_2^9, \dots, v_2^{4k+1}\} \cup \{v_2^2, v_2^6, v_2^{10}, \dots, v_2^{4k+2}\}$$

In each case, all the vertices are monitored either by direct domination or by propagation. Thus,  $M(S) = V(\mu(G))$  and hence  $S$  is a power dominating set of required cardinality (Fig 5.4).  $\square$

**Remark 5.2.1.** There are cases in which the upper bound in the Theorem 5.2.2 is attained. For instance,  $\gamma_p(\mu_2(P_3)) = 2$ . It is clear that a single vertex cannot power dominate the whole graph in this case.(Fig 5.5.)



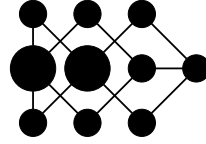

Fig 5.5:  $\{v_2, v_2^1\}$  is a power dominating set in  $\mu_2(P_3)$

### 5.3 The direct product

**Theorem 5.3.1.**  $\gamma_p(K_m \times K_n) = 2$ , for  $m + n > 5$ .

*Proof.* It is clear that if  $m + n < 5$ , then  $\gamma_p(K_m \times K_n) = 1$ .  $K_m \times K_n$  is a  $(m-1)(n-1)$  regular graph. Hence, a single vertex can power dominate  $(m-1)(n-1)$  vertices. There are  $m+n-2$  vertices which are not monitored after the domination step. At this stage, any dominated vertex is either non-adjacent to all these  $m+n-2$  vertices or is adjacent to  $m+n-4$  of these vertices. This means that propagation step is possible if and only if  $m+n = 5$  in which case the power domination number is one. In all other cases any single vertex cannot monitor the whole graph.

Let  $\{(v_{ij}) | i \in \{1, 2, \dots, m\} \text{ and } j \in \{1, 2, \dots, n\}\}$  be the vertex set of  $K_m \times K_n$ . We shall show that  $\{v_{11}, v_{mn}\}$  will form

a power dominating set. The vertex  $v_{11}$  will dominate the set  $\{v_{ij}/2 \leq i \leq m, 2 \leq j \leq n\}$  and the vertex  $v_{mn}$  will dominate the set  $\{v_{ij}/1 \leq i \leq m-1, 1 \leq j \leq n-1\}$ . At this stage,  $v_{1n}$  and  $v_{m1}$  are the only unmonitored vertices. These vertices will be monitored by propagation from  $v_{(m-1)1}$  and  $v_{2n}$  respectively.  $\square$

**Theorem 5.3.2.** *Let  $m \geq 3$ ,  $n \geq 4$  and  $G = K_m \times C_n$ . Then*

$$\gamma_p(G) = 2k, \text{ if } n = 4k$$

$$\gamma_p(G) = 2k + 1, \text{ if } n = 4k + 1$$

$$\gamma_p(G) = 2k + 2, \text{ if } n = 4k + 2 \text{ or } n = 4k + 3.$$

*Proof.* Let  $\{(v_{ij}) | i \in \{1, 2, \dots, m\} \text{ and } j \in \{1, 2, \dots, n\}\}$  be the vertex set of  $K_m \times C_n$ . Consider the set  $S$  defined as follows:

(i) If  $n = 4k$  :

$$S = \cup_{i=1}^k \{v_{1(4i-3)}\} \cup \cup_{i=1}^k \{v_{1(4i-2)}\}.$$

(ii) If  $n = 4k + 1$  :

$$S = \cup_{i=1}^k \{v_{1(4i-3)}\} \cup \cup_{i=1}^k \{v_{1(4i-2)}\} \cup \{v_{1(4i-1)}\}.$$

(iii) If  $n = 4k + 2$  :

$$S = \cup_{i=1}^k \{v_{1(4i-3)}\} \cup \cup_{i=1}^k \{v_{1(4i-2)}\} \cup \{v_{1(4i-1)}\} \cup \{v_{1(4i)}\}.$$

(iv) If  $n = 4k + 3$  :

$$S = \cup_{i=1}^{k+1} \{v_{1(4i-3)}\} \cup \cup_{i=1}^{k+1} \{v_{1(4i-2)}\}.$$

In each case, all the vertices are monitored either by direct domination or by propagation. Thus,  $M(S) = V(G)$  and hence  $S$  is a power dominating set of required cardinality. An illustration

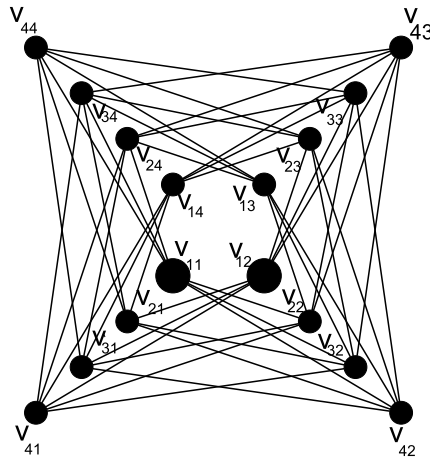

Fig 5.6: The set  $\{v_{11}, v_{12}\}$  is a power dominating set in  $K_4 \times C_4$

is given in Fig: 5.6.

Now, we shall prove that these are lower bounds in each case.

We have the following,

**Claim:**

Let  $p_2 : K_m \times C_n \rightarrow C_n$  be the natural projection onto  $C_n$  . If  $n \geq 3$  and  $S$  is a power dominating set of  $K_m \times C_n$ , then for

every subpath  $P \subset C_n$  of length three,  $p_2(S) \cap P$  contains at least two vertices.

*Proof of Claim:* Suppose there exists a path  $P = x_1x_2x_3x_4$  such that  $|p_2(S) \cap P| < 2$ . If  $p_2(S) \cap P = \{x_1\}$ , during domination process no vertices of  $K_m^{x_3}$  is monitored. Moreover any neighbor of a vertex of  $K_m^{x_3}$  has at least two neighbors which are not monitored after domination. Hence no vertex of  $K_m^{x_3}$  is monitored after propagation step, which is a contradiction. Argument for the case  $p_2(S) \cap P = \phi$  is analogous.

Now, when  $n = 4k$  there are  $4k$  vertices in  $C_n$  out of which  $2k$  should belong to  $S$  and hence  $|S| \geq 2k$ . If  $n = 4k + 1$ , then  $2k$  vertices are required to dominate  $4k$ ,  $K_m$  fibers and since there are  $4k + 1$ ,  $K_m$  fibers one more vertex is needed. Hence  $|S| \geq 2k + 1$ . Similarly, when  $n = 4k + 2$  or  $n = 4k + 3$ ,  $2k$  vertices are needed to dominate  $4k$ ,  $K_m$  fibers and another two more vertices are needed to dominate the remaining two or three  $K_m$  fibers as the case may be. This implies  $|S| \geq 2k + 2$ .  $\square$

**Theorem 5.3.3.** *Let  $n$  be an even integer and  $G = C_m \times P_n$ .*

*Then,*

$$\gamma_p(G) = 2 \left\lceil \frac{n}{3} \right\rceil, \text{ if } m \text{ is even.}$$

$$\gamma_p(G) = \left\lceil \frac{n}{3} \right\rceil, \text{ if } m \text{ is odd.}$$

*Proof.* Let  $\{(v_{ij}) | i \in \{1, 2, \dots, m\} \text{ and } j \in \{1, 2, \dots, n\}\}$  be the vertex set of  $C_m \times P_n$ .

**Case 1:**  $m$  is even.

$C_m \times P_n$  is then a disconnected graph with two isomorphic components. Let  $G'$  be the component of  $G$  containing the vertex  $v_{12}$  and consider the set  $S$  defined as follows:

(i) If  $n = 3k$ :

$$S = \{v_{12}, v_{18}, \dots, v_{1(3k-4)}, v_{25}, \dots, v_{2(3k-1)}\}.$$

(ii) If  $n = 3k + 1$ :

$$S = \{v_{12}, v_{18}, \dots, v_{1(3k-1)}, v_{25}, \dots, v_{2(3k-4)}, v_{3(3k+1)}\}.$$

(iii) If  $n = 3k + 2$ :

$$S = \{v_{12}, v_{18}, \dots, v_{1(3k-4)}, v_{25}, \dots, v_{2(3k-1)}, v_{3(3k+2)}\}.$$

In each case, all the vertices are monitored either by direct domination or by propagation. Thus,  $M(S) = V(G')$  and hence  $S$  is a power dominating set of  $G'$ . Also,  $|S| = \left\lceil \frac{n}{3} \right\rceil$  and thus  $\gamma_p(G') \leq \left\lceil \frac{n}{3} \right\rceil$ . An illustration is given in Fig: 5.7.

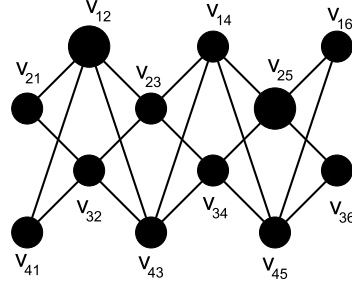

Fig 5.7: The set  $\{v_{12}, v_{25}\}$  is a power dominating set in  $G'$

Now, we shall prove that it is a lower bound as well. Any vertex  $v_{ij}$  can cover at most three  $C_m$  fibers and further propagation is not possible. But there are  $n$ ,  $C_m$  fibers which means that at least  $\lceil \frac{n}{3} \rceil$  are needed to monitor all the vertices. Thus, we have  $\gamma_p(G') \geq \lceil \frac{n}{3} \rceil$  and  $\gamma_p(G) = 2 \lceil \frac{n}{3} \rceil$ .

**Case 2:**  $m$  is odd.

$C_m \times P_n$  is then a connected graph. Consider the set  $S$  defined as follows:

(i) If  $n = 3k$ :

$$S = \{v_{12}, v_{18}, \dots, v_{1(3k-4)}, v_{25}, \dots, v_{2(3k-1)}\}.$$

(ii) If  $n = 3k + 1$ :

$$S = \{v_{12}, v_{18}, \dots, v_{1(3k-1)}, v_{25}, \dots, v_{2(3k-4)}, v_{3(3k+1)}\}.$$

(iii) If  $n = 3k + 2$

$$S = \{v_{12}, v_{18}, \dots, v_{1(3k-4)}, v_{25}, \dots, v_{2(3k-1)}, v_{3(3k+2)}\}.$$

In each case, all the vertices are monitored either by direct domination or by propagation. Thus,  $M(S) = V(G)$  and hence  $S$  is a power dominating set of  $G$  with cardinality  $\lceil \frac{n}{3} \rceil$ . An illustration is given in Fig: 5.8.

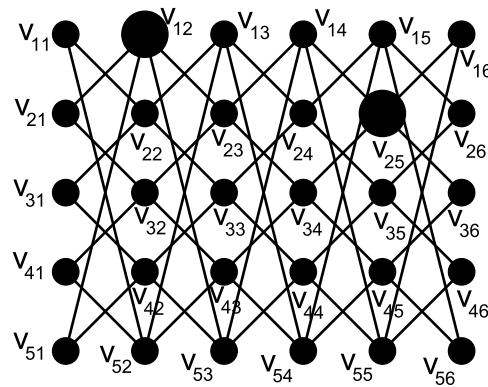

Fig 5.8: The set  $\{v_{12}, v_{25}\}$  is a power dominating set in  $C_5 \times P_6$

Now, we shall prove that it is a lower bound as well. Any vertex  $v_{ij}$  can cover at most three  $C_m$  fibers and further propagation is not possible. But there are  $n$ ,  $C_m$  fibers which means that at least  $\lceil \frac{n}{3} \rceil$  are needed to monitor all the vertices.  $\square$

**Theorem 5.3.4.** *If  $G$  and  $H$  are graphs with two universal vertices each, then  $\gamma_p(G \times H) \leq 2$ .*

*Proof.* Let  $V(G) = \{u_1, u_2 \dots u_m\}$  with  $d(u_1) = d(u_2) = m - 1$  and  $V(H) = \{v_1, v_2 \dots v_n\}$  with  $d(v_1) = d(v_2) = n - 1$ . Let  $\{u_i v_j / 1 \leq i \leq m \text{ and } 1 \leq j \leq n\}$  be the vertex set of  $G \times H$ . Consider the set  $S = \{u_1 v_1, u_2 v_2\}$ .  $N(u_1 v_1) = \{u_i v_j / 2 \leq i \leq m \text{ and } 2 \leq j \leq n\}$  and  $N(u_2 v_2) = \{u_i v_j / i \neq 2 \text{ and } j \neq 2\}$ . Hence  $S$  is a power dominating set for  $G \times H$  and  $\gamma_p(G \times H) \leq 2$ .  $\square$

## 5.4 The Cartesian product

In this section, we identify the Cartesian product of some classes of graphs with small power domination number. We compute the power domination number of the classes of graphs  $K_m \square P_n$ ,  $K_m \square C_n$ ,  $K_m \square W_n$ ,  $K_m \square F_n$ .

**Theorem 5.4.1.**  $\gamma_p(K_m \square P_n) = 1$

*Proof.* Let  $\{(v_{ij}) | i \in \{1, 2, \dots, m\} \text{ and } j \in \{1, 2, \dots, n\}\}$  be the vertex set of  $K_m \square P_n$  (Fig 5.9). The vertex  $v_{11}$  will di-



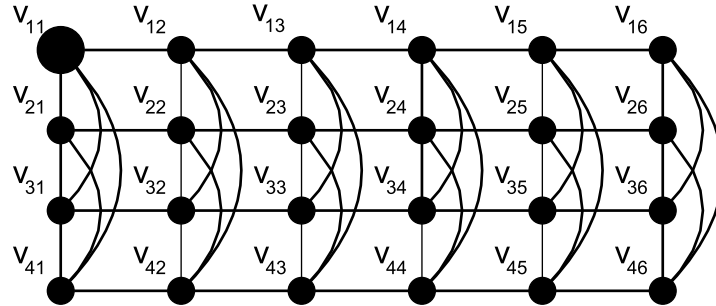

Fig 5.9: The vertex  $v_{11}$  is a power dominating set in  $K_4 \square P_6$

rectly monitor  $K_m^{v_{11}}$  and also the vertex  $v_{12}$ . Now, each vertex of  $K_m^{v_{11}}$  has all its neighbors monitored except its neighbor in  $K_m^{v_{12}}$ . Thus,  $K_m^{v_{12}}$  is monitored by propagation. Similar arguments show that the whole graph is monitored by the single vertex  $v_{11}$ .  $\square$

**Theorem 5.4.2.**  $\gamma_p(K_m \square C_n) = 2$ , for  $m > 2, n \geq 4$

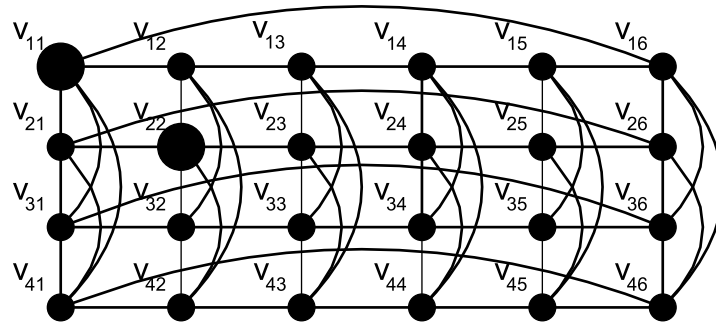

Fig 5.10: The set  $\{v_{11}, v_{22}\}$  is a power dominating set in  $K_4 \square C_6$

*Proof.* Let  $\{(v_{ij})|i \in \{1, 2, \dots, m\} \text{ and } j \in \{1, 2, \dots, n\}\}$  be the vertex set of  $K_m \square C_n$ , where any  $K_m$ -fiber induces a complete subgraph and any  $C_n$ -fiber induces a cycle (Fig 5.10). The graph  $K_m \square C_n$  is a  $m + 1$  regular graph, where any vertex can dominate  $m + 2$  vertices. Further propagation step is not possible since every vertex has at least two unmonitored neighbors. By arguments similar to that of Theorem 5.4.1, it can be shown that any two vertices of the form  $\{v_{ij}, v_{(i+1)(j+1)}\}$  will monitor the whole graph.  $\square$

**Remark 5.4.1.** When  $m \leq 2$  and  $n = 3$ ,  $\gamma_p(K_m \square C_n) = 1$ .

**Theorem 5.4.3.**  $\gamma_p(K_m \square W_n) = 3$ , for  $m \geq 4, n \geq 4$ , where  $W_n$  is a wheel on  $n$  vertices.

*Proof.* Let  $\{(v_{ij})|i \in \{1, 2, \dots, m\} \text{ and } j \in \{1, 2, \dots, n\}\}$  be the vertex set of  $K_m \square W_n$ , where any  $K_m$ -fiber induces a  $K_m$  and any  $W_n$ -fiber induces a  $W_n$  (Fig 5.11). Any vertex of  $K_m^{v_{11}}$  can dominate  $m + n - 1$  vertices and further propagation is not possible since every monitored vertex has at least two unmonitored neighbors. Similarly, any vertex which do not belong to  $K_m^{v_{11}}$  can dominate  $m + 1$  vertices and further propagation is not possible. Hence, any single vertex cannot monitor the whole graph.

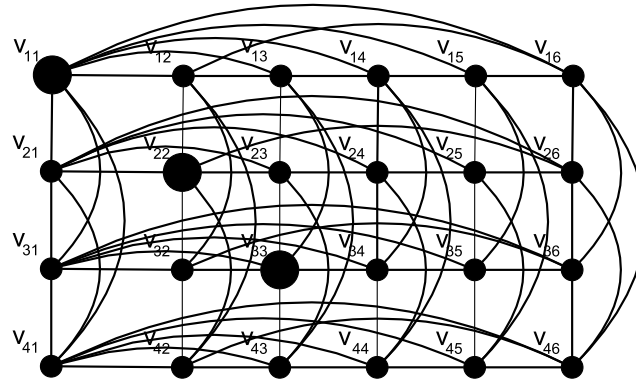

Fig 5.11: The set  $\{v_{11}, v_{22}, v_{33}\}$  is a power dominating set in  $K_4 \square W_6$

We shall now show that the set  $\{v_{11}, v_{22}, v_{33}\}$  is a power dominating set for the graph  $K_m \square W_n$  and hence  $\gamma_p(K_m \square W_n) \leq 3$ . The vertex  $v_{11}$  will dominate  $K_m^{v_{11}}$  and  $v_{11}W_n$  and further propagation is impossible. The vertex  $v_{22}$  will dominate  $K_m^{v_{22}}$  and the vertices  $v_{21}, v_{23}$  and  $v_{2n}$  without any possibility for further propagation. Now, the vertex  $v_{33}$  dominates  $K_m^{v_{33}}$  and the vertices  $v_{31}, v_{32}$  and  $v_{34}$ . At this stage, each vertex of  $K_m^{v_{33}}$  has exactly one unmonitored neighbor which is in  $K_m^{v_{44}}$  and hence  $K_m^{v_{44}}$  is monitored by propagation from  $K_m^{v_{33}}$ . By repeated propagations, we see that the whole graph is monitored.

Now it remains to show that any choice of two vertices will not suffice. Let  $\{v_{ij}, v_{kl}\}$  be any two arbitrary vertices  $\{v_{ij}, v_{kl}\}$ . Consider the case when  $i = k = 1$ , i.e the set  $\{v_{1j}, v_{1l}\}$ . The vertex  $v_{1j}$  dominates  $K_m^{v_{1j}}$ , the vertices  $v_{1(j-1)}$  and  $v_{1(j+1)}$  whereas the vertex  $v_{1l}$  dominates  $K_m^{v_{1l}}$ , the vertices  $v_{1(l-1)}$  and  $v_{1(l+1)}$ . Further propagation is not possible since all the dominated vertices has at least two unmonitored neighbors. Hence,  $\{v_{1j}, v_{1l}\}$  can dominate at most two  $K_m$  fibers, but there are  $n > 4$ ,  $K_m$  fibers. Arguments for other cases are analogous.  $\square$

**Theorem 5.4.4.**  $\gamma_p(K_m \square F_n) = 2$ , for  $m \geq 3, n \geq 3$ , where  $F_n$  is a fan on  $n$  vertices.

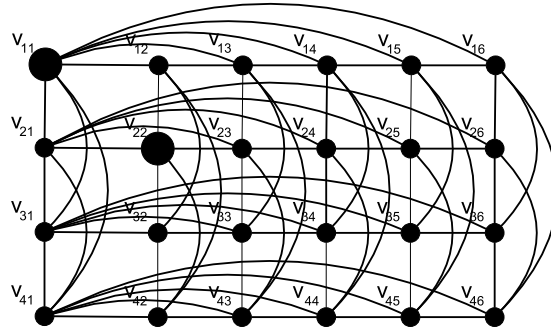

Fig 5.12:  $\{v_{11}, v_{22}\}$  power dominates  $K_4 \square F_6$

*Proof.* Let  $\{(v_{ij}) | i \in \{1, 2, \dots, m\} \text{ and } j \in \{1, 2, \dots, n\}\}$  be the vertex set of  $K_m \square F_n$ , where any  $K_m$ -fiber induces a  $K_m$

and any  $F_n$ -fiber induces a  $F_n$  (Fig 5.12). Any vertex of  $K_m^{v_{11}}$  can dominate  $m + n - 1$  vertices and further propagation is not possible since every monitored vertex has at least two unmonitored neighbors. Similarly, any vertex which do not belong to  $K_m^{v_{11}}$  can dominate  $m + 1$  vertices and further propagation is not possible. Hence, any single vertex cannot monitor the whole graph.

We shall now show that the set  $\{v_{11}, v_{22}\}$  is a power dominating set for the graph  $K_m \square F_n$  and hence  $\gamma_p(K_m \square F_n) = 2$ . The vertex  $v_{11}$  will dominate  $K_m^{v_{11}}$  and  $v_{11}F_n$  and further propagation is impossible. The vertex  $v_{22}$  will dominate  $K_m^{v_{22}}$  and the vertices  $v_{21}$  and  $v_{23}$ . At this stage, each vertex of  $K_m^{v_{22}}$  has exactly one unmonitored neighbor which is in  $K_m^{v_{33}}$  and hence  $K_m^{v_{33}}$  is monitored by propagation from  $K_m^{v_{22}}$ . By repeated propagations, we see that the whole graph is monitored.

□

**Remark 5.4.2.** When  $m = 2$  or  $n = 2$ ,  $\gamma_p(K_m \square F_n) = 1$ .

# Conclusion

We conclude the thesis by giving some suggestions for further study.

The outerplanarity [53] of iterated star-line graphs can be investigated. It would also be interesting to study the  $\langle t \rangle$ -property [4] in the class of H-line graphs. The behaviour of  $L_H(G)$  when  $G$  is a Cartesian product, direct product etc. can be studied in detail. Also, one can attempt to study the relationship between the graph parameters like radius, diameter, domination number of  $G$  and  $L_H(G)$  for particular choices of  $H$ .

The characterization of cycle graphs is still an open problem. Although, it seems difficult to get a complete characterization, one may try to get a characterization for cycle graphs which belong to some particular classes. In this thesis, we have obtained the condition for cycle graph to be connected. Hence, the relationship between  $\kappa(G)$  and  $\kappa(\text{Cy}(G))$  in the class of graphs where  $\text{Cy}(G)$  is connected can be studied in detail.

The power domination problem is a very vibrant area today. Since the problem is NP-hard for general graphs, a result for some particular classes is significant. Characterization of graphs with  $\gamma_p(G) = 1$  and that of graphs with  $\gamma_p(G) = \gamma(G)$  is particularly interesting. Also, characterization of graphs with  $\gamma_P(\mu(G)) = 1$ ,  $\gamma_P(\mu(G)) = \gamma_p(G)$ ,  $\gamma_P(\mu(G)) = \gamma_p(G) + 1$  may be attempted. The generalized Mycielskian of cycles form a network like structure. Hence, its power domination number and network parameters-degree, diameter, cost can be obtained and compared with other networks. The relationship between the power domination number and the zero forcing number discussed in [22] can be studied in detail.

# List of symbols

$c(G)$	-	Circumference of $G$
$C_n$	-	Cycle of length $n$
$Cy(G)$	-	Cycle graph of $G$
$\deg(v)$	-	Degree of $v$
$d(G)$	-	Diameter of $G$
$d(u, v)$ or $d_G(u, v)$	-	Distance between $u$ and $v$ in $G$
$E$ or $E(G)$	-	Edge set of $G$
$e(u)$	-	Eccentricity of $u$
$g(G)$	-	Girth of $G$
$G^c$	-	Complement of $G$



$G \cong H$	- $G$ is isomorphic to $H$
$G \square H$	- Cartesian product of $G$ and $H$
$G \times H$	- Direct product of $G$ and $H$
$G \vee H$	- Join of $G$ and $H$
$G \circ H$	- Corona of $G$ and $H$
$L_H(G)$	- $H$ -line graph of $G$
$HM_n$	- Hexagonal honeycomb grid of dimension $n$
$K_{m,n}$	- Complete bipartite graph where $m$ and $n$ are the cardinalities of the partitions
$K_n$	- Complete graph on $n$ vertices
$L(G)$	- Line graph of $G$
$m$ or $m(G)$	- Number of edges of $G$
$N[v]$	- Closed neighborhood of $v$
$N(v)$	- Open neighborhood of $v$
$nG$	- $n$ disjoint copies of $G$
$n$ or $n(G)$	- Number of vertices of $G$

---

$P_n$	-	Path on $n$ vertices
$r(G)$	-	Radius of $G$
$RT_{m,n}$	-	Rectangular Triangular grid of dimension $(m, n)$
$T_n$	-	Triangular grid of dimension $n$
$\lceil x \rceil$	-	Smallest integer $\geq x$
$\lfloor x \rfloor$	-	Greatest integer $\leq x$
$V$ or $V(G)$	-	Vertex set of $G$
$\langle V \rangle$	-	Graph induced by $V$
$\alpha(G)$	-	Independence number of $G$
$\alpha'(G)$	-	Edge independence number or Matching number of $G$
$\gamma(G)$	-	Domination number of $G$
$\gamma_p(G)$	-	Power domination number of $G$
$\Delta(G)$	-	Maximum degree of vertices in $G$
$\kappa(G)$	-	Vertex connectivity of $G$
$\kappa'(G)$	-	Edge connectivity of $G$
$\delta(G)$	-	Minimum degree of vertices in $G$

- $\mu(G)$  - Mycielskian of  $G$
- $\mu_m(G)$  - Generalized  $m$ -Mycielskian of  $G$
- $\Phi^n(G)$  -  $n^{\text{th}}$  iterated graph of  $G$  under  $\Phi$
- $\zeta(G)$  - Line index of  $G$
- $\zeta_n(G)$  -  $n$ -star line index of  $G$

# Bibliography

- [1] A. Aazami, Domination in graphs with bounded propagation: algorithms, formulations and hardness results, *J. Comb. Optim.* 19 (2010), 429-456.
- [2] R. Akhtar, T. Jiang, D. Pritikin, Edge bandwidth of the triangular grid, *Elect. J. of Combin.* 14 (2007), #R67.
- [3] Aparna Lakshmanan S, Studies on Some Graph Classes, Ph.D Thesis, Cochin University of Science and Technology, (2008).
- [4] Aparna Lakshmanan S, A. Vijayakumar, The  $\langle t \rangle$ -property of some classes of graphs, *Discrete Math.* 309 (2009), 259-263.

- 
- [5] Aparna Lakshmanan S, S. B. Rao, A. Vijayakumar, Gallai and antiGallai graphs of a graph, *Math. Bohem.* 132(1) (2007), 43-54.
- [6] J. S. Bagga, L. W. Beineke, B. N. Varma, The super line graph  $L_2$ , *Discrete Math.* 206 (1999), no. 1-3, 51-61.
- [7] R. Balakrishnan, Triangle Graphs in: Graph Connections (Cochin, 1998) Allied Publ., New Delhi. (1999), p.44.
- [8] R. Balakrishnan, S. Francis Raj, Connectivity of the Mycielskian of a graph, *Discrete Math.* 308(2008), 2607-2610.
- [9] R. Balakrishnan, K. Ranganathan, A Text Book of Graph Theory, Springer (1999).
- [10] P. Baldi, P. Frasconi, P. Smyth , Modeling the Internet and the Web, John Wiley (2003).
- [11] R. Barrera and D. Ferrero. Power domination in cylinders, tori and generalized Petersen graphs, Article first published online: *Networks*, 18 oct 2010.
- [12] L. W. Beineke, On derived graphs and digraphs, in *Beitrage zur Graphentheorie*, Leipzig, (1968), 17-23.

- 
- [13] C. Berge, *Theory of Graphs and its Applications*, Methuen, London, (1962).
- [14] N. L. Biggs, E. K. Lloyd, R.J. Wilson, *Graph Theory 1736-1936*, Clarendon Press, Oxford, (1976).
- [15] A. Brandstädt, V. B. Le, J. P. Spinrad, *Graph Classes*, SIAM (1999).
- [16] A. Bonato, *A Course on the Web Graph*, The American Mathematical Society (2008).
- [17] R. A. Britto-Pacumio, Limits of iterated H-line graphs, *Discrete Math.*199(1999), 1-10.
- [18] F. Buckley, F. Harary, *Distance in Graphs*, Addison-Wesley(1990).
- [19] G. J. Chang, L. Huang, X. Zhu, Circular chromatic numbers of Mycielski's graphs, *Discrete Math.* 205(1999), 23-27.
- [20] G. Chartrand, H. Gavlas, M. Schultz, Convergent sequences of iterated H-line graphs, *Discrete Math.*147(1995), 73-86.
- [21] G. Chartrand, M. A. Henning, E. B. Jarrett, C. E. Wall, Quadrilateral line graphs, *Utilitas Math.*, 50(1996), 3-17.

- 
- [22] K. B. Chilakamarri, N. Dean, C. X. Kang, E. Yi, Iteration index of a zero forcing set in a graph, arXiv:1105.1492v1 [math.Co],2011.
- [23] E. J. Cockayne, S. T. Hedetniemi, Towards a theory of domination in graphs, *Networks* 7 (1977), 247-261.
- [24] R. Cohen, S. Havlin, *Complex Networks: Structure, Robustness and Function*, Cambridge University Press (2010).
- [25] C. F. Doeller, C. Barry, N. Burgess, Evidence for grid cells in human memory network, *Nature* 463 (2010), 657-661.
- [26] P. Dorbec, M. Mollard, S. Klavžar and S. Špacapan. Power domination in product graphs, *SIAM J. Discrete Math.* 22 (2008), no. 2, 554-567.
- [27] M. Dorfling, M. A. Henning, A note on power domination in grid graphs, *Discrete Appl. Math.* 154 (2006), 1023-1027.
- [28] D. Dorrough, Convergent sequences of iterated triangular line graphs, *Discrete Math.*161(1996), 79-86.
- [29] D. Ferrero, Seema Varghese, A. Vijayakumar, Power domination in honeycomb networks, (Accepted by *J. Discrete Math. Sciences and Crypt.*).

- 
- [30] D. C. Fisher, P. A. McKenna, E. D. Boyer, Hamiltonicity, diameter, domination, packing and biclique partitions of Mycielski's graphs, *Discrete Appl. Math.* 84 (1998), 93-105.
- [31] S. V. Gervacio, Cycle graphs, *Lecture Notes in Mathematics* 1073, (1983), 279-293.
- [32] M. Ghebleh, M. Khatirinejad, Planarity in iterated line graphs, *Discrete Math.* 308 (2008), 144-147.
- [33] D.L.Greenwell, R. L. Hemminger, J. Klerlein, Forbidden Subgraphs, *Proceedings of Fourth South-eastern Conference on Combinatorics, Graph Theory and Computing*, (1973), 389-394.
- [34] J. L. Gross, J. Yellen, *Graph Theory and its Applications*, CRC Press LLC, (1998).
- [35] M. C. Golumbic, *Algorithmic Graph Theory and Perfect Graphs*, Academic Press, New York, (1980).
- [36] F. Harary, *Graph Theory*, Addison-Wesley Publishing Company, Inc. (1969).



- 
- [37] T. W. Haynes, S. M. Hedetniemi, S. T. Hedetniemi, M. A. Henning, Domination in graphs applied to electric power networks, *SIAM J. Discrete Math.* 15 (2002), 519-529.
- [38] T. W. Haynes, S. T. Hedetniemi, P. J. Slater, *Fundamentals of Domination in Graphs*, Marcel Dekker, Inc. (1998).
- [39] R. Hochberg, C. McDiarmid, M. Saks, On the bandwidth of triangulated triangles, *Discrete Math.* 138(1995), 261-265.
- [40] L. H. Hsu, C. K. Lin, *Graph Theory and Interconnection Networks*, CRC Press, (2009).
- [41] W. Imrich, S. Klavžar, D. F. Rall, *Topics in Graph Theory: Graphs and their Cartesian Product*, A. K. Peters Ltd, Wellesley, Massachusetts, (2008).
- [42] W. Imrich, S. Klavžar, *Product Graphs: Structure and Recognition*, John Wiley & Sons, New York, (2000).
- [43] E. B. Jarrett, On iterated triangular line graphs, in: Y. Alavi, A. Schwenk(Eds), *Proc. 7th Internat. Conf. in Graph Theory, Combinatorics, Algorithms, and Applications*, Wiley, New York, (1994).

- 
- [44] S. Klavžar, B. Mohar, I. Gutman, Labeling of benzenoid systems which reflects the vertex distance relation, *J. Chem. Info. Comput. Sci.* 35 (1995), 590-593.
- [45] J. Kneis, D. Mölle, S. Richter, P. Rossmanith, Parameterized power domination complexity, *Inform. Process. Lett.* 98 (2006), no. 4, 145-149.
- [46] J. Krausz, Démonstration nouvelle d'un théorème de Whitney sur les réseaux (Hungarian with French summary), *Mat. Fiz Lapok* 50 (1943), 75-85.
- [47] K. Kuratowski, Sur le problème des courbes gauches en topologie, *Fund. Math.* 15 (1930), 271-283.
- [48] S. Klavžar, P. Žigert, I. Gutman, An algorithm for the calculation the hyper-Weiner index of benzenoid hydrocarbons, *Comput. Chem.* 24 (2000), 229-233.
- [49] M. Larsen, J. Propp, D. Ullman, The fractional chromatic number of Mycielski's graphs, *J. Graph Theory* 19 (1995), 411-416.
- [50] V. B. Le, Gallai and anti-Gallai graphs, *Discrete Math.* 159 (1996), 179-189.

- 
- [51] C. S. Liao and D. T. Lee, Power domination problems in graphs, *Lecture Notes in Comput. Sci.* 3595 (2005), 818-828.
- [52] W. Lin, J. Wu, P.C.B. Lam, G. Gu, Several parameters of generalized Mycielskians, *Discrete Appl. Math.* 154 (2006), 1173-1182.
- [53] H. Lin, W. Yang, H. Zhanga, J. Shua, Outerplanarity of line graphs and iterated line graphs, *Applied Mathematics Letters* 24 (2011), 1214-1217.
- [54] Manju. K. Menon, *Studies on Some Graph Operators and Related Topics*, Ph.D Thesis, Cochin University of Science and Technology, India, (2009).
- [55] Manju. K. Menon, A. Vijayakumar, Dynamics of  $P_3$ -intersection graph, *JCMCC* 73 (2010), 127-134.
- [56] J. Mycielski, Sur le coloriage des graphes, *Colloq. Math.* 3 (1955), 161-162.
- [57] M. E. J. Newman, The Structure and Function of Complex Networks, *SIAM Rev.* 45 (2003), 167-256.

- 
- [58] O. Ore, Theory of Graphs, Amer. Math. Soc. Colloq. Publ., Amer. Math. Soc., Providence, RI, 38 (1962).
- [59] E. Prisner, Graph Dynamics, Longman (1995).
- [60] Seema Varghese, A.Vijayakumar, On  $H$ -line graphs, (Submitted).
- [61] Seema Varghese, A.Vijayakumar, On the planarity of iterated star-line graphs, (Submitted).
- [62] Seema Varghese, A.Vijayakumar, Power domination in triangular grids and Mycielskian of graphs, (Submitted).
- [63] Seema Varghese, A.Vijayakumar, On cycle graphs, (Submitted).
- [64] I. Stojmenovic. Honeycomb networks, Proc. Math. Foundations of Comput. Sci. MFCS'95 on Lecture Notes in Comput. Sci. 969 (1995), 267-276.
- [65] I. Stojmenovic. Honeycomb networks: topological properties and communication algorithms, IEEE Transactions on Parallel and Distributed Systems 8 (10) (1997), 1036-1042.

- 
- [66] E. L. Tan, Classification of graphs according to their cycle graphs, Mathematical Methods Proceedings, Chiang Mai University, Thailand (1988).
- [67] J. J. Watkins, Across the Board: The Mathematics of Chessboard Problems, Princeton University Press, (2004).
- [68] D.B. West, Introduction to Graph Theory, PHI (2003).
- [69] H. Whitney, Congruent graphs and the connectivity of graphs, Amer. J. Math. 54 (1932), 150-168.
- [70] A. M. Yaglom, I. M. Yaglom, Challenging Mathematical Problems with Elementary Solutions, in: Combinatorial Analysis and Probability Theory, Vol.1, San Francisco, Holden Day, (1964).
- [71] M. Zhao, L. Kang , G. J. Chang, Power domination in graphs, Discrete Math. 306(2006), 1812-1816.
- [72] M. Zhao, L. Kang, Power domination in planar graphs with small diameter, Journal of Shanghai University (English Edition), 11(3) (2007), 218-222.

# Index

- $u-v$  path, 10
- adjacent
  - edges, 8
  - vertices, 8
- anti-Gallai graph, 32
- antigallai graph, 20
- bipartite graph, 12, 31
- block, 13, 66
- boundary, 27
- Cartesian product, 16, 117
- caterpillar, 10, 105
- chord, 11
- chordal, 11
- circumference, 10
- claw, 12
- clique, 11
- closed neighborhood
  - of a set, 11
  - of a vertex, 11
- complement, 12
- complete
  - bipartite graph, 12
  - graph, 11
- component, 10
- contractible, 15
- contraction, 15
- converge, 18
- corona, 15
- cover, 27
- cover a diagonal, 25
- cut vertex, 12
- cycle, 10
- cycle graph, 23, 33, 65

- 
- inverse , 23
  - iterated, 23
  - cycle-persistent, 23
  - cycle-vanishing, 23
  - cylinder, 16
  - degree, 8
  - diagonal, 25, 27, 88, 96
  - diameter, 11
  - direct product, 17, 110
  - distance, 11
  - divergent, 18
  - dominating set, 14
  - domination number, 14
  - eccentricity, 11
  - edge connectivity, 13
  - end vertex, 8
  - $\Phi$ -fixed, 19
  - face, 13
  - fan, 15
  - fiber, 17
  - forbidden subgraph, 9
    - characterization, 9, 30, 46
  - girth, 10, 71
  - graph, 7
    - $\mathcal{C}$ -free, 9
    - acyclic, 10
    - chordal, 11, 75
    - connected, 10
    - disconnected, 10
    - Eulerian, 10
    - finite, 7
    - $H$ -free, 9
    - maximal outerplanar, 13
    - null, 8
    - outerplanar, 67
    - outerplane, 13
    - planar, 31
    - plane, 13
    - trivial, 8
    - unicyclic, 10
  - grid, 16

- 
- hexagonal honeycomb, 25, 36, 88
  - triangular, 37, 94
  - H*-line graph, 20, 32, 45, 49
  - hamiltonian, 10
  - homeomorph, 14, 31
  - incident, 8
  - independence number, 14
    - edge, 14, 46
  - independent
    - edge set, 14
    - vertex set, 14
  - induced hereditary, 9, 30
  - internal vertex, 10
  - intersection graph, 17
  - isolated vertex, 8
  - isomorphic, 8
  - iterated graph operator, 18
  - join, 15
  - k*-vertex cut, 12
  - k*-regular, 8
  - length, 10
  - line graph, 18, 30, 31, 50
  - line index, 33
  - matching, 14
  - matching number, 14
  - monitored set, 24
  - Mycielskian, 28, 37, 100
    - generalized, 29
  - n*-connected, 12
  - n*-star-line index, 21, 52
  - open neighborhood
    - of a set, 11
    - of a vertex, 11
  - order, 8
  - origin, 9
  - outerplanar, 13, 31
  - path, 10
  - paw, 11



- 
- pendant  
    edge, 8  
    vertex, 8
- period, 19
- periodic, 18
- planar, 13
- planar embedding, 13
- power dominating set, 25, 90, 93
- power domination number, 25, 87
- radius, 11
- rectangular triangular grid, 27
- root, 28
- self complementary, 12
- size, 8
- spine, 10
- star, 12
- star-line graph, 20, 50
- subdivision of a graph, 14
- subdivision of an edge, 14
- subgraph, 9  
    induced, 9  
    spanning, 9
- super-line graph, 32
- terminus, 9
- torus, 16
- totally disconnected, 12
- trail, 10
- tree, 10, 68
- triangle, 11
- triangle graph, 22  
    inverse, 22
- triangular grid, 26
- triangular line graph, 19, 32
- twin, 28
- universal vertex, 8
- vertex connectivity, 12
- walk, 9
- wheel, 15, 75