

U 8892

POLYPHOSPHATE ACCUMULATION BY MARINE BACTERIA

Thesis Submitted to the
Cochin University of Science and Technology
UNDER THE FACULTY OF SCIENCE

In partial fulfillment of the requirements
For the degree of

**DOCTOR OF PHILOSOPHY
IN
BIOTECHNOLOGY**

By

Dasan E. V., MSc, MBBS

DEPARTMENT OF BIOTECHNOLOGY
COCHIN UNIVERSITY OF SCIENCE AND TECHNOLOGY
KOCHI - 682 022, INDIA

JANUARY 2002



DEPARTMENT OF BIOTECHNOLOGY
COCHIN UNIVERSITY OF SCIENCE AND TECHNOLOGY
COCHIN - 682 022

Phone : (0484) 559267, Fax : 91-0484-532495. E-mail : mchandra@cusat.ac.in

Prof. (Dr.) M. CHANDRASEKARAN
PROFESSOR OF BIOTECHNOLOGY

Date : 07-01-2002

CERTIFICATE

This is to certify that the work presented in the thesis entitled "POLYPHOSPHATE ACCUMULATION BY MARINE BACTERIA " is based on the original research done by DASAN E.V. under my guidance and supervision at the Department of Biotechnology and no part there of has been included in any other thesis for the award of any degree.



M. Chandrasekaran

Contents

1 INTRODUCTION	1
1.1 Preface	1
1.2 Review of Literature	7
1.3 Scope of The Present Study	21
2 MATERIALS AND METHODS	22
2.1 Sample	22
2.2 Collection and transport of Samples	22
2.3 Medium	22
2.4 Isolation of Heterotrophic bacteria	22
2.5 Screening of the cultures for phosphate uptake and polyP Accumulation	23
2.5.1 First phase screening	23
2.5.1.1 Inoculum preparation	23
2.5.1.2 Inoculation and Incubation	23
2.5.1.3 Assay	23
2.5.1.3.1 Estimation of various Phosphates	24
2.5.1.3.2 Total Cellular Protein	24
2.5.2 Second Phase Screening	24
2.5.2.1 Total cell protein	25
2.5.2.2 Estimation of the phosphates	25
2.6 Identification of Bacteria	25
2.7 Selection of Potential Strains for further studies	25
2.8 Impact of different conc. of phosphate in the medium on Pi uptake and polyphosphate accumulation by marine bacteria	26
2.8.1 Medium	26
2.8.2 Inoculum preparation	26
2.8.3 Inoculation and Incubation	26
2.8.4 Estimation of Biomass and Phosphates	27
2.9 Impact of pH on Pi uptake and polyP accumulation by marine bacteria	27

2.10	Impact of Incubation Temperature on Pi uptake and polyP accumulation by Marine bacteria	27
2.11	Impact of Additional Sodium chloride concentration in the medium on Pi Uptake and polyP accumulation by marine bacteria	27
2.12	Effect of other additional inorganic salts in the medium on Pi uptake and polyP accumulation by marine bacteria	28
2.12.1	KCl	28
2.12.2	CaCl ₂	28
2.12.3	MgSO ₄	29
2.12.4	Sodium Citrate	29
2.12.5	Ammonium Nitrate	29
2.13	Effect of other additional organic carbon sources in the medium on Pi uptake and polyP accumulation by marine bacteria	30
2.13.1	Peptone	30
2.13.2	Yeast Extract	30
2.13.3	Glucose	30
2.14	Statistical analyses	31
3	RESULTS	32
3.1	Screening of polyphosphate accumulating bacteria from marine environments	32
3.1.1	First Phase Screening	32
3.1.2	Identification of Short listed Isolates	33
3.1.3	Second Phase Screening	33
3.1.3.1	Biomass	33
3.1.3.2	Phosphate Removal	34
3.1.3.3	Cellular free Pi	35
3.1.3.4	Low Molecular Weight Phosphates	35
3.1.3.5	Polyphosphate	36
3.1.3.6	Nucleic acid phosphates	37
3.2	Selection of Potential Strains capable of accumulating polyphosphate	38

3.3.	Effect of Phosphate conc. in the medium on phosphate uptake and polyphosphate accumulation by marine bacteria	38
3.4	Effect of pH on phosphate uptake and polyphosphate accumulation by Marine bacteria <i>Vibrio</i> sp	41
3.5	Effect of Temperature on Pi uptake and polyP accumulation by marine bacteria	43
3.6	Effect of Sodium Chloride	44
3.7	Other Inorganic Salts	46
	3.7.1. Potassium Chloride (KCl)	46
	3.7.2 Calcium Chloride	48
	3.7.3 Magnesium Sulphate	50
	3.7.4 Sodium Citrate	51
	3.7.5 Ammonium Nitrate	53
3.8	Other Additional Organic Carbon Sources	55
	3.8.1 Peptone	55
	3.8.2 Yeast Extract	57
	3.8.3 Glucose	58
	4 DISCUSSION	61
	5 SUMMARY & CONCLUSION	78
	REFERENCES	84

1.INTRODUCTION

1.1 Preface

Phosphate(Pi) is one among the most important essential residues in maintenance and inheritance of life, with far diverse physiological roles as structural, functional, and energy transduction. In nature, Pi is often a growth-limiting factor, being an essential constituent in all types of living organisms. It is a ubiquitous residue present in most biomolecules ranging from PPi to DNA. Many organisms have evolved complex regulatory systems to assimilate Pi efficiently and accumulate a Pi reserve. It is present in the phospholipids, which make the cellular membranes and the various intracellular compartments. It's function in energy transduction stores energy as high energy phosphate bonds in ATP, CP, other nucleotide biophosphate, high energy phosphorylated molecules like Phosphoenol pyruvate (PEP), polyphosphate (polyP), and it might be much more than what is known to date. Almost all the known biochemical processes for energy metabolism, synthesis and break down of carbohydrates, fats, proteins, nucleic acids and poly,P need Pi residue as the essential moiety. It is involved in the various extra and intracellular signal transduction, excitation, action potential generation and propagation in all excitable tissues, nerves and muscular tissue. High-energy phosphate bond is the key in actin myosin interaction executing the muscle contraction, movements of the cells and organs ranging from fibroblasts, smooth muscles, heart etc.

Phosphate accumulation in wastewaters containing run off of fertilizers and industrial discharges is a global problem that results in algal blooms in bays, lakes, and waterways. The outbreak of algal blooms is one of the environmental concerns resulting from eutrophication in lakes and other surface waters (Ohtake *et al.*, 1985). Algal booms degrade water quality by producing an offensive odour and taste. The nuisance growth of algae renders boating and fishing difficult and discourages swimming. Excessive growth of algae consumes dissolved oxygen when aerobic bacteria leading to mass mortality of fish and other aquatic organisms decompose them. Algal toxin is also a serious problem in drinking water supplies.

Pi is found to be the limiting factor for algal growth in nature and it's removal from wastewater can effectively control the algal eutrophication of surface waters (Hammond, 1971). Activated sludge process used for wastewater treatment is very effective in removing organic pollutants but this removes Pi relatively poorly. To make activated sludge more effective in

removing P_i , it appears essential to enable sludge microorganisms to take up and store P_i in excess of their requirement for growth (Ohtake, *et al.*, 1985). The uses of chemical methods like lime, alum or ferric chloride to remove P_i is expensive and inefficient. Currently biological phosphorus removal processes utilizing anaerobic and aerobic conditions have been adopted for sewage and wastewater treatment. Under aerobic conditions the activated sludge microbes accumulated excess P_i in the cell and it was released during the anaerobic phase. This principle is utilized in activated sludge process for P_i removal from wastewater, in which the P_i is effectively removed along with the sludge microbes (Ohtake, *et al.*, 1985). In this process aerobically activated bacteria take up the phosphate and convert to polyphosphate (polyP), which is then removed along with the bacteria as a sludge.

Activated sludge with good phosphorus removal capacity shows clear phosphate release under anaerobic conditions and phosphate uptake under aerobic conditions (Cemeau *et al.*, 1986). This release and uptake of phosphate corresponded stoichiometrically to the change in polyP content of activated sludge (Cemeau *et al.*, 1986).

Currently available methods for removing phosphates from wastewater are based primarily on polyP accumulation by the activated sludge bacteria (Ohtake, *et al.*, 1985). However, because of the complexity of the sludge microbes and the limited knowledge about their polyP metabolism, the process operates essentially by the "black box" principle with less predictability and stability. These processes require the sludge microorganisms to be subjected to alternating aerobic and anaerobic cycles. P_i uptake by the sludge microbes takes place under aerobic conditions while P_i release under the anaerobic phase. The conventional wastewater treatment systems could be induced to accumulate phosphate significantly in excess to the requirement for the normal bacterial growth. This process is called enhanced biological phosphorus removal (EBPR) (Toerien, *et al.*, 1990).

The characteristic feature of EBPR plant is the alternating anaerobic and aerobic phases where the influent wastewater and the return sludge are mixed together at the beginning of the plant with an anaerobic zone (no aeration) and an aerobic zone (aerated) at the end of the plant. Presence of anaerobic zone was found to be essential in order to obtain significant phosphate removal (Davelaar, *et al.*, 1978). Phosphate is efficiently removed during the aerated zone after its release during the anaerobic phase, and the (EBPR) plant obtains almost complete removal of phosphate from the wastewater, in addition to the carbon and nitrogen removal. The microbial flora

of the activated sludge was found to be complex and the Pi removal mechanism remains less understood. The acidogenic bacteria (catalyzing degradation of complex substrates to acetate), nitrifying organisms (catalyzing oxidation of ammonium to nitrite and nitrate), denitrifying organisms (catalyzing conversion of nitrate to nitrogen) and the strictly aerobic bacteria have been studied (Toerien, *et al.*, 1990). *Acinetobacter* sp. is reported to be important in phosphate removal of EBPR (Fuhs and Chen, 1975), and EBPR process is now widely used to remove excess phosphate from wastewater. Understanding how the energy state of the cell and the environmental phosphate levels affect polyP metabolism is essential for further improvement in efficiency and predictability of the system (Keasling, *et al.*, 2000).

The economy of phosphate removal processes will be enhanced to be profitable if it is combined with fertilizer industries like ammonium phosphate, and ammonium polyphosphate industries which has rapidly grown over the last 10 years to meet the growing demand of ammonium phosphate in world wide agriculture. Basically, there is only one commercial method for producing ammonium phosphate and that is by the reaction of ammonia with phosphoric acid although many variations have been added in the process techniques and objective in the recent times. The fertilizer ammonium phosphate contains either orthophosphate or polyphosphates or mixture of both, containing a variety of polymeric forms mixed with some orthophosphate. The stream efficiencies of fertilizer plants are normally lower than the average in the chemical industry, because of the problems of corrosion, handling melts, slurries and particles. The microbiological processes can open newer ways of manufacturing large-scale phosphate and polyP containing fertilizers in harmony with the environment and maintaining environmental sanitation.

Microorganisms remove Pi from environment through phosphate uptake mechanism, which involves a biphasic pumping system in bacteria. The two pumping systems (i) Phosphate Inorganic Transport system (**Pit**), constitutively expressed in the cell (Wanner, 1996), is a less specific system and active at high Pi concentrations in their environment. Under these conditions, Pi is stored in the form of polyP reserve for future survival under Pi starvation. **Pit** is a mono component membrane channel. (ii) Phosphate specific transport system (**Pst**) - This becomes active when Pi level in the medium lowers, under conditions of Pi limitation, and serves as the major scavenger of Pi. **Pst** is a four-component membrane channel formed of the sub units, **PstS**, **PstA**, **PstB**, **PstC**, which are coded by the respective four genes. These four structural genes along with a regulatory site (**phoU**) together constitute an operon called **pho regulon** which regulates the **Pst** system.

Many organisms have evolved complex regulatory systems to assimilate Pi efficiently and accumulate polyP as a Pi reserve. The only known pathway for biosynthesis of polyP is from ATP by polyphosphate kinase (PPK). PolyP turnover is mediated by PPK, Exo / endopolyphosphatase, polyP glucokinase, polyP fructokinase, polyP adenylate kinase and polyP AMP phosphotransferase enzymes, indicating its physiological importance.

PolyP plays a critical role in several environmental and biotechnological problems. Understanding how environmental conditions affect native polyP metabolism and manipulation of polyP metabolism through genetic and metabolic engineering can ultimately lead to newer and cost effective processes to remove contaminants especially phosphate and heavy metals from the waste water, reassuring environmental health and sanitary conditions.

Biologically synthesized polyP is a linear polymer of a few tens to many hundreds of inorganic orthophosphoric acid (Pi) residues linked by high-energy phospho-anhydride bonds (Kulaev, 1975). PolyP has been detected in abundance in all the living forms ranging from the prokaryotes to mammals, plants, in the volcanic condensates, and deep oceanic steam vents, indicating that it can be formed spontaneously by simple condensation of orthophosphoric acids under high temperature. PolyP is present in the mammalian cells and sub-cellular organelles like mitochondria, lysosomes, while relatively higher in nuclei. PolyP is more abundant in microbes than in plants and animals (Kornberg, 1995).

In bacteria polyP accumulation occurs under conditions of nutritional imbalance unfavorable for growth (Harold, 1966). It has been shown that many bacteria exhibit rapid and extensive poly P accumulation, called **polyP over plus**, when Pi is added to cells previously subjected to Pi starvation stress (Harold, 1966). However, the mechanism underlying polyP accumulation is not clearly known

PolyP is now thought to be as ubiquitous and more ancient than Nucleic acids (NA) and likely a prominent precursor of N.A in prebiotic evolution. It is probably evident from its presence in volcanic condensates and deep oceanic steam vents. In spite its occurrence in every living organisms ranging from bacteria, fungi, protozoa, plants and animals including mammals (Kulaev, 1979), polyP has been ignored and dismissed as a "molecular fossil" (Kornberg, 1995). RNA preceded DNA and proteins in evolution, while PolyP might have appeared before any of these organic polymers, as ubiquitous and more ancient than nucleic acids, likely as a prominent precursor in prebiotic evolution

Physiological roles implicated to polyP are many while the exact role of polyP is yet unknown. However, it is believed to have several roles (i) as a source of energy due for ready conversion to ATP as well as other nucleotide triphosphates by PPK (ii) as a cellular Pi reservoir (iii) as a substitute for ATP in kinase reactions, (iv) as cellular chelator for metals - Ca²⁺, Mg²⁺, Mn²⁺, (v) as a buffer against alkaline stress, (vi) as a regulator for transcription, (vii) in developing competence and forming the channel for DNA entry during transformation.

Poly P has several applications such as:

(i) as an ATP (NTPs) regenerating system in biochemical and industrial use. The cost of ATP for use as an enzymatic phosphorylating agent on an industrial scale is prohibitive as is the cost of agents, such as creatine P; and Phosphoenol pyruvate, that might be used in an enzymatic ATP- regenerating system, polyP has been used in their place (Butler, 1977). (ii) As an antibacterial agent used in all processed meat, poultry, and fish products. In its use in virtually all processed meat poultry and fish products, polyP also serves as an antibacterial agent. (iii) As a safe additive to meat it enhances water binding, emulsification, colour retention, and antioxidant capacity. (iv) It is used in cheese, tooth paste, and drinking water. (v) Inhibitors of PPK might be effective broad-spectrum antimicrobial tools especially against antibiotic resistant bacteria. (vi) In depollution of phosphate from the environment. (vii) As a component of chemical fertilizers for slow and prolonged Pi release, have osmotic and pH advantage in the soil. (viii) As Insulating fibers. A calcium polyphosphate fiber has been synthesized with all the properties of asbestos and could be a safe substitute (Griffith, 1992). PolyP can be potentially employed to generate ATP using PPK in industrial processes, as a component of chemical fertilizers and its other economic market values might be of great help for promoting the use of engineered microbes for removing Pi from wastewaters.

Several strains have been isolated from the activated sludge with high polyP accumulation ranging from 4-10% dry weight, as in *Acinetobacter* (Fuhs and Chen, 1975) and *Arthrobacter globiformis* (Shoda *et al.*, 1980) However, in spite of their high polyP, none of the above strains exhibited the characteristic aerobic Pi uptake and anaerobic Pi release properties of the activated sludge with acceptable Pi removal (Nakamura *et al.*, 1991) isolated *Microlunatus phosphovorius* from the activated sludge which accumulated polyphosphate under aerobic conditions and released it under anaerobic conditions, with Pi accumulation of 10-20mg/g cell. Many microbes accumulate excess Pi as polyP under unfavourable growth condition such as low pH, anaerobiosis, sulfur starvation (Harold, 1966). Some bacteria take up Pi far in excess of their requirements for growth

and accumulate polyP after being subjected to Pi starvation by the predominance of PPK action during this condition (Harold 1963, Ohtake *et al.*, 1985).

Pseudomonas putida HAS 29, isolated from a bench scale activated sludge system designed for enhanced biological Pi removal, showed the characteristic property of activated sludge, taking up Pi and accumulation as polyP under aerobic condition and release of Pi and polyP breakdown under anaerobic conditions (Ohtake *et al.*, 1999).

Genetic improvement of bacteria to remove Pi from waste waters have been tested, using *E.coli* as the test organism, and the ability of *E.coli* MV 1184 to accumulate polyP was enhanced by modifying genetic regulation and increasing the dosage of the gene encoding PPK, Acetate kinase (ACK) and the **Pst** system (Vieira and Messing, 1987).

Accumulation of phosphate is a constant process in the marine environment resulting from the death and decay of the inhabitant plants and animals as well as from the inflowing waters carrying wastes from the land. Marine bacteria are thus exposed to higher Pi concentration in the environment and have become part of the active phosphate cycle of the marine ecosystem. Thus they are expected to have relatively better Pi uptake and polyP accumulation, besides tolerance to osmotic and toxic stress, for probable exploitation in the wastewater treatment. In this context of the need for new and better strains for phosphate removal from waste water and potential uses of polyP, an attempt was made in the present study to screen potential polyP accumulating bacteria.

1.2 Review of Literature

Phosphate uptake

Pi transport into bacterial cells is accomplished by several parallel transport systems (Wanner, 1996). Two of the better characterized Pi transport systems are the constitutively expressed, low affinity **Pit** system and the carefully regulated high affinity **Pst** system. The **Pit** system is a simple component transporter belonging to the group of systems which are energized by the proton motive force (Elvin *et al.*, 1986).

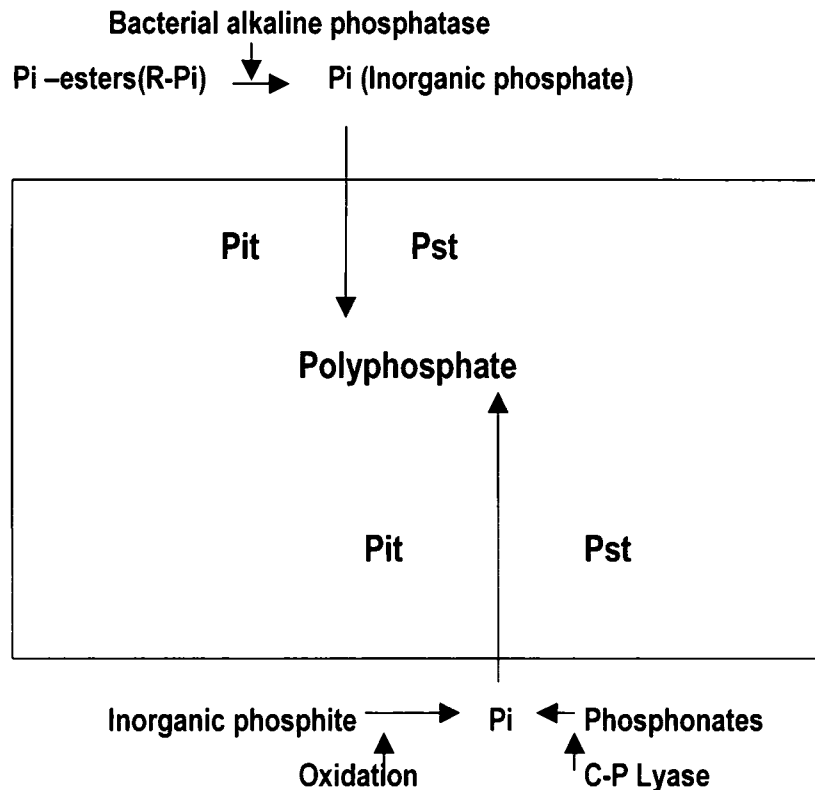

The **Pst** system is a periplasmic protein dependent transporter and belongs to the super family of ABC (ATP- binding cassette) transporters (Higgins, 1992). The **Pst** system is induced by Pi limitation and serves as a major scavenger of Pi residues under conditions of Pi limitation

Bacteria use inorganic Pi as the preferred source of phosphate and its uptake is by a biphasic Pi transport system where one mechanism will function at a higher phosphate level and other operate at the Pi levels lower in their environment. When in excess, Pi is taken up by the Phosphate inorganic transport system (**Pit**) which is made constitutively in the cell (Wanner, 1996),

and under this condition bacteria can store Pi in the form of polyphosphate as a reserve for Pi and other functions (Kornberg, 1995). Since polyP can serve as a Pi source for the biosynthesis of nucleic acids, phospholipids and other biochemical molecules under the conditions of Pi starvation (Harold, 1963), its accumulation is likely to be a protective mechanism for survival during Pi starvation. Bacteria have evolved a much more complex system to survive during Pi starvation conditions. Under conditions of Pi limitation the phosphate specific transport (**Pst**) system is turned on, and this system serves as a major scavenger of Pi residue. When inorganic Pi is not available bacteria use other forms of phosphate like organophosphates (phosphate esters) inorganic phosphite (Pt) and phosphonates (Pn) as alternatives. Most organophosphates are not transportable as such and the phosphate has to be released from the source before being taken up by a process which involve hydrolytic cleavage catalyzed by a variety of enzymes secreted by the bacteria including alkaline phosphatase (Bap) which is made at very high levels under condition's of Pi starvation (Wanner, 1996).

Phosphonates are large class of organophosphorous molecules with direct carbon phosphorous (C-P) bonds unlike the (-C-O-P-) ester bond between carbon and phosphate. Hence, utilization of these compounds for Pi require cleavage of the C-P bond by the enzyme C-P lyase. However, Pt seems to be enzymatically oxidized to Pi before being used as a phosphate source, which is also induced by Pi starvation stress(Wanner ,1996).

Studies with *Acinetobacter* sp. have showed that the largest quantity of Pi was removed within the first hour during the lag phase compared to 24 hrs uptake (Muyima and Cloete, 1995) and the results also indicated that Pi was released slowly between 2 and 8 hrs and removed significantly after 24 hrs. Excess Pi removal was reported to occur mainly under aerobic conditions, while Pi uptake and release processes were reversible (Ohake, *et al.*, 1985). In the activated sludge process, when the aerobic phase of the cycle exceeds 4 hrs, a slow release of Pi occurs even during the aerobic phase (Osborn and Nicholls, 1978). However, the intracellular phosphate accumulations vary according to the environmental factor (Kulaev and Vagabov, 1983).

The phenomenon of luxury uptake, polyP over plus and polyP accumulation, and release have been demonstrated in many bacteria. When, *E.coli* cells accumulated excessive levels of polyP, they released it into the medium, probably as a mechanism by which a further increase in cellular polyP is limited. This release was first observed during Pi uptake experiment with *E.coli* MV 1184 strain (Kato *et al.*, 1993a). Rate of polyP release was essentially equivalent to that of Pi uptake after the cells accumulated excessive levels of it and stopped when the Pi in the medium

was removed completely and resumed on addition of Pi, to the culture. PolyP release was stopped when the Pi uptake was inhibited by 0.1mM carbonyl cyanide m – chlorophenyl hydrazone (Hardoyo *et al.*, 1994)

In *E.coli* PPK preferentially attaches to the outer membrane even though ATP is the substrate of the enzyme (Akiyama *et al.*, 1992). This location of PPK and the lack of a leader sequence to translocate it to the outer membrane suggest that the enzyme may be present in Bayer patches, described as fusions of inner and outer membranes communicating directly between the cell exterior and interior compartments (Bayer, 1968).

Klebsiella aerogenes, which is closely related to *E coli*, exhibits extensive polyP accumulation and there are two patterns for the process (Harold, 1966). When growth and nucleic acid synthesis are blocked by depriving the organism of sulfate, Pi uptake from the medium continues, resulting in polyP accumulation, and this phenomenon is called “**luxury uptake**” (Fuhs and Chen, 1975). This process is now known to occur in many bacteria, including those isolated from the activated sludge samples, when the growth is arrested by lack of a nutrient other than Pi. On the other hand, addition of Pi to *Klebsiella aerogenes* cells previously subjected to Pi starvation induces rapid and extensive accumulation of polyP and upon resumption of growth and nucleic acid synthesis, the polyP is gradually degraded by conversion to nucleic acids. This pattern of polyP synthesis is called **polyP overplus**. Potassium, Mg, and a source of energy are likely required for polyP overplus in *K. aerogenes* (Harold, 1966).

In *K. aerogenes* PPK activity increased in response to Pi starvation and decreased upon addition of Pi, but PPX activity did not increase during Pi starvation. This is in contrast to the response in *E.coli* where PPK and PPX levels were quite similar even under conditions of Pi limitation. The difference between PPK and PPX activities is likely responsible for polyP overplus in *K. aerogenes* (Ohtake, *et al.*, 1999). The genetically modified *Klebsiella* (ATCC 9621) bearing multicopy own **ppk** removed approximately 80% of the Pi from the medium while normal strain removed only 50% with in the first 2 hrs. It accumulated 0.9µM polyP per mg protein and as Pi 20% of its dry weight. However, multicopy **ppk-ppx** did not improve Pi uptake. The results suggest the potential of genetic improvement of *K. aerogenes* for enhanced polyP accumulation (Ohtake, *et al.*, 1999).

With the cloning of the gene encoding PPK it has become possible to genetically engineer polyP accumulation in bacteria which are needed to improve the maximal Pi uptake efficiency of the

useful strains that dominate the flora of activated sludge especially *Acinetobacter* strains (Kornberg, 1995). PPK has been cloned in *E.coli* showing enhanced rate and extent of Pi removal from the medium, which when coupled with cloning of **pst** gene for Pi specific transport Pi uptake and polyP accumulation reached as high as 38-48% of the dry weight of the cell (Hardoyo *et al.*, 1994).

Understanding the fundamentals regarding the biochemical mechanisms and genetics of bacterial Pi transport and metabolism is essential for improving their abilities to remove Pi from waste waters as well as their perspective application in other areas (Ohtake, *et al.*, 1996). To date the available informations on **ppk** is limited to that from *E.coli* and *Klebsiella aerogenes*. Moreover, understanding PO₄ metabolism can add to the basic knowledge of cell biology, the normal and abnormal, and genetic improvement of the bacterial polyP accumulation will serve as the first step to make sludge microorganisms more effective in Pi removal from waste waters. There is a growing interest in the role of polyP accumulation in biological Pi removal from waste waters (Hardoyo *et al.*, 1994).

Genetic improvement of bacterial polyP accumulation may serve as the first step to make sludge microorganisms more effective in removing Pi from wastewaters. Pi uptake studies using the engineered and wild strain *E.coli* showed increasing the dosage of **ppk** gene alone doubled the Pi uptake and Pi content of *E.coli* (Kato *et al.*, 1993 a). Introduction of **ppk** and acetate kinase (**ack**) genes into *E.coli* (MV1184) resulted in much more improvement than **ack** alone, attaining almost 90% Pi removal within 4 hrs growth.

Efficiency of *E.coli* MV 1184 (Vieira and Messing, 1987) to accumulate polyP was enhanced by modifying genetic regulation and increasing the dosage of the gene encoding PPK, Acetate kinase (ACK) and the **Pst** system. Kinetic analysis suggested Pi transport across the cell membrane as the possible rate-limiting step for polyP, accumulation in *E.coli*. When recombinant *E.coli* accumulated high levels of polyP, they released phosphate compounds into the medium (Hardoyo *et al.*, 1994). PolyP release might be probably a mechanism by which a further increase in cellular polyP is limited and the rate of this polyP release was found to be dependent on that of Pi uptake. However, no polyP release was observed after the complete removal of Pi from the medium by the cells and resumed polyP release soon after the addition of Pi into the medium.

Effect of Environmental factors on phosphate uptake and cellular metabolism

The uptake and storage of phosphate was influenced by the external pH in mycorrhizal roots of pine and the fungus of *Suillus bovinus* (Thomas and Anke, 1997). External pH in the range of 3.5-8.5 influenced the Pi metabolism in mycorrhizal roots and the fungus in pure culture used the accumulated Pi as mobile polyP, while the internal pH was found to be constant. The Pi uptake rate and polyP accumulation responded differently to external pH. In all cases, maximal Pi uptake occurred at an external pH close to 5.5 and at pH 8.5, both the roots and the fungus showed a distinct lag in Pi uptake, which was reversed when the external pH was lowered to 7.5.

An irreversible effect on Pi uptake was also observed as a consequence of variation in external pH. In the upper range of external pH, Pi uptake and storage was strongly inhibited as a consequence of insolubility of phosphate at pH 8.5, as at this pH uptake was not possible and polyP concentration was maximum at pH 7.5. An external pH above 9 may cause increase in internal pH (Torimitsu *et al.*, 1984).

Three mechanisms have been proposed, which maintain this constant internal pH. They include (i) a purely passive inflow and outflow (ii) an active mechanism driven by Na⁺/K⁺ pump (iii) an energy consumptive, Na⁻ coupled Cl⁻ – HCO₃⁻ exchange (Roos and Boron, 1981). A passive mechanism cannot keep internal pH constant for longer periods of 3-4 hrs. An ATP requiring active mechanism must be involved and in higher plants one of these mechanisms is metabolically controlled using malate dehydrogenase / phosphoenolpyruvate carboxylase (Davies, 1973).

In addition, intracellular pH is maintained by proton transport (Serrano, 1984) and co-transport of anions (Hager *et al.*, 1981, 1984) by a H⁺ATPase (Rea and Poole, 1986) and a pyrophosphatase (Hager *et al.*, 1986). In roots a pool of energy is commonly represented by sugar phosphates. It has been postulated for mycorrhizal fungi that vacuolar polyphosphate could be an energy source. Non mycorrhizal roots did not show polyP at any pH (Harley *et al.*, 1954, Martin *et al.*, 1985).

At pH 8.5 there was no detectable Pi uptake, which may be due to an increase in insoluble CaHPO₄ complex in the medium decreasing the available phosphate with an increase in pH, cycle 6.5 → 8.5 → 6.5, while, returning back to pH 6.5 led to increase in available Pi, uptake, and polyP (Thomas and Anke, 1997). Several divalent cations like Mg²⁺, CO₂²⁺, Mn²⁺, Zn²⁺ stimulate the yeast mitochondrial soluble polyphosphatase (Lichko, *et al.*, 2000). Mg²⁺ is also a prosthetic group in

pyrophosphatase enzymes. Ca^{2+} replace Mg^{2+} from the inorganic pyrophosphatase of *E.coli* inhibiting the enzyme activation and catalysis. Ca^{2+} is a powerful inhibitor of all known pyrophosphatases (Avaeva, *et al.*, 2000).

Studies on *S. cerevisiae* have showed that the length of the polyphosphate chain is dependent on the orthophosphate content in the culture medium. When grown in a complete medium during the early hours of growth yeast accumulated low molecular mass chains initially followed by elongation of the chains to high molecular mass polymers, later. After 7 hrs of phosphate starvation the yeast used the phosphate reserve in the form of polyphosphate in the various cell compartments almost completely to support their vitality, which was evidenced by considerable shortening of the polyP chains during starvation. On a complete medium, there was initially active synthesis of short chains. During the early logarithmic phase the degree of polymerization declined drastically and the high polymer polyP chains were detected at the late stationary phase, when the synthesis was stopped (Vagabov, *et al.*, 2000).

Based on a comparative analysis of cellular Pi and polyP in 8 strains of the photosynthetic bacteria (4 each from seawater and fresh water), one marine *Chromatium* Sp. strain was selected and the effect of NaCl and seawater on intracellular Pi and polyP was studied. Intracellular phosphate and polyP content increased up to 280mM NaCl and 40-50% seawater was found to be optimum (Hiroaki *et al.*, 1997).

Poly phosphate (PolyP)

Polyphosphate was observed as the metachromatic granules in yeast for the first time by Liebermann (1888). However, it was only after the studies conducted by Wiame (1947), Ebel (1948), Kornberg *et al.*, (1956), Belozersky (1958), Lohmann (1958) and others during the late 1940 and 1950s this biological molecule received due attention of the scientific community. The metachromatic granules were used as a diagnostic feature of medically important bacteria like *Corynebacterium diphtheriae* during the last two centuries and it was thought to be nucleic acid particles. Decades later, Wiame (1947), while viewing under an electron microscope, observed these granules to disintegrate and volatilize by the beam of electrons unlike the nuclear materials and later recognized them as a polymer of inorganic orthophosphoric acid residues. Later, an enzyme in *E.coli* that formed the polymer of inorganic phosphate from ATP and readily converted the polymer back to ATP was found and identified as polyphosphate kinase (PPK)(Kornberg *et al.*, 1956).

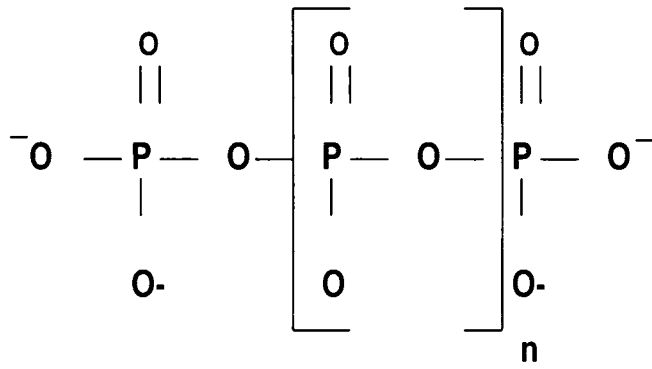

Structure of inorganic polyphosphate chain

PolyP arises from Pi by simple dehydration and condensation at elevated temperatures which is evident in the volcanic condensates and deep oceanic steam vents (Yamagata, *et al.*, 1991). The anhydride bond energy and Pi of polyP are possible sources for nucleoside triphosphates which form the building blocks of RNA and DNA (Waehneltd and Fox, 1967, Kulaev and Skryabin, 1974). Mixed carboxylic – phosphate anhydrides provide a route to chemical polypeptide synthesis starting with amino acid and polyP (Harada and Fox, 1965). Among the species of phosphates special mention should be made for the simplest member, pyrophosphate (PPi) which was believed solely as a metabolic product in the various biosynthetic reactions and hydrolyzed by the potent enzyme inorganic pyrophosphatase to drive these pathways (Kornberg, 1957). Later studies showed PPi to be a substitute for ATP (Wood, 1985). A role for PPi as well as for the long chain polyP in prebiotic events leading to the evolution of ATP deserves attention (Kornberg, 1995). PolyP accumulation is also prominent in Archaeobacteria and may be the substrates for enzymatic attack by nucleoside, mono, di or triphosphates. A systematic search among these ancient organisms might uncover enzymes that carry out such salvage reactions in the biosynthesis of nucleotides, co-enzymes and other factors.

Despite the prominence of polyP in many organisms such as in the vacuolar deposits of yeast cells, which may represent 10-20% of cellular dry weights, this molecule remains least attended. Studies of Harold (1966), Kulaev (1987) Wood (1988) and few others disclosed the

ubiquity of polyP and identified a few related enzyme activities. Almost 99% of the yeast cellular polyP is seen in their vacuoles.

Several enzymes have been purified and used for studies on polyP metabolism (Ahn and Kornberg, 1990, Akiyama, *et al* 1993, Wurst and Kornberg, 1994). They include PPK and exo polyPhosphatase from *E.coli* (PPX2) and exo poly phosphatase from *S. cerevisiae* (PPX 1). Two more enzymes available for polyP analysis are polyP glucokinase and polyPphosphotransferase which attack the terminal residue of polyP with glucose (Hsieh *et al* 1993) and AMP respectively (Bonting *et al*; 1991). PolyP is more abundant in microbes than in higher forms and the diversity of accumulation range from its undetectable level in *E.coli* to as high as 20% dry weight in *S. cerevisiae*.

Although the presence of polyP had been noted widely in prokaryotes, fungi and algae, the distribution and abundance of polyP in more complex eukaryotic forms remained uncertain. The very low levels in animal cells and sub-cellular compartments left polyP obscure till recently due to lack of definitive and sensitive methods to analyse and study its metabolic and functional role (Gabel and Thomas, 1971). Recent exploratory studies with improved enzymatic assay methods have confirmed presence of polyP in a wide variety of cells in cultures and animal tissues. The concentration of which generally range from 10-100 μ M as Pi equivalents and in sizes of 100-1000 residues (Kumble and Kornberg, 1995). Among the sub cellular organelles, polyP has been identified in lysosomes (Pisoni and Lindley, 1991) and in mitochondria (Kornberg, 1995) and is relatively enriched in nuclei (Kumble and Kornberg 1995).

Biosynthesis of polyP

Biologically synthesized polyP is a linear polymer of few tens to many hundreds of orthophosphoric acid residues linked by high-energy phosphoanhydride bonds. Polyphosphate kinase(PPK) enzyme synthesise polyP from ATP with a more favoured reverse reaction.



PPK purified to homogeneity from *E.coli* catalyzes the readily reversible transfer of the terminal (β) phosphate of ATP to polyP. The enzyme is a homotetramer of 80 K.D. subunits. With ADP in excess PPK converts nearly 90% of the polyP to ATP which was identified by using ¹⁴

CADP and ^{32}P – polyP. The only known pathway for this synthesis of polyP is from ATP PPK (Ahn and Kornberg, 1990).

The Gene encoding this kinase, **ppk**, is part of an operon immediately upstream to the gene for exopolyphosphatase(PPX), **ppx**, thus along with a regulatory site constituting **ppk/ppx operon**(Akiyama *et al.*, 1992). PPX of *E.coli*, a dimer of 58 KD subunits, hydrolyzes the terminal residues of polyP to Pi recessively and nearly completely with a strong preference for long chain polyP (Akiyama *et al.*, 1993).

A third enzyme exopolyphosphatase isolated from *Saccharomyces cerevisiae* (ScPPX1) is the most powerful of them, releasing as high as 30,000 Pi residues per min/ enzyme molecule at 37°C (Wurst and Kornberg, 1994).). It acts with 40 times the specific activity of *E.coli* PPX and exhibit a far broader size range for polyP from 3-1000 residues. Cloning the gene for this enzyme in *E.coli* have enabled over production of the enzyme. It is suggested that this enzyme may be used to remove the polyP contaminating any DNA preparations besides use as an analytical reagent for polyP (Rodriguez, 1993). The gene encoding PPK (**ppk**) has been cloned, sequenced, knocked out and even over expressed in *E.coli* (Akiyama *et.al* 1992). It is located at 53.4 min of *E. coli* linkage map. The open reading frame encodes a sequence of 687 amino acids (mass of 80.278 KD), and the enzyme is a homotetramer.

PPK from *Klebsiella aerogenes* have been cloned and the nucleotide sequence analysis of **ppk** of *Klebsiella aerogenes* showed that the PPK protein shared 93% amino acid residues with *E.coli* PPK protein (Kato *et al.*, 1993a). PPK- polymerizes the terminal Pi of ATP into polyP in a freely reversible reaction (Kornberg, 1995).Utilization and degradation of polyp is catalyzed by exopolyphosphatase (PPX) and several polyP specific kinases including, polyP glucokinase and polyP fructokinase (Kulaev, 1975). Both PPK and PPX seem to be made constitutively in *E.coli* and polyP accumulation is not induced by Pi starvation stress in *E.coli*, but as a result of stringent response (Kuroda and Kornberg, 1997a).

To date the genes encoding PPK have been cloned and sequenced from a group of bacteria, including *E.coli* (Akiyama *et al.*, 1992),. *K. aerogenes* (Kato *et al.*, 1993b) *Neisseria meningitidis* (Tinsley and Gotschlich, 1995), *Acinetobacter calcoaceticus* (Geissdorfer *et al.*, 1995), and *Pseudomonas putida* HAS 29 (Chandrasekaran, 1998). *Pseudomonas putida* PPK gene codes

polypeptide chain of 741 amino acid, which showed only 32% homology with amino acid sequence of *E.coli* PPK, while 53% with *A. calcoascticus* PPK. (Ohtake *et al.*, 1999).

Polyphosphate plays an important regulatory role in the virulence of pathogens, gene knock out mutants of *P. aeruginosa* lacking PPK lack motility, quorum sensing, biofilm formation and as a result are turned avirulent (Kornberg, 2000).

The ATP regenerating system consisting of ADK, PPK, and polyP was shown to be promising for practical utilization of polyP as ATP substitute (Kornberg 1995). In *E.coli* highest amount of high polymer polyP occurs only in the end of latent and beginning of logarithmic growth phase. When the culture passes to exponential growth, the level of intracellular polyP dramatically decreases. Thus polyP accumulation precedes active growth and it is utilized by the growing cells (Nesmeyanova, 2000). Several enzymes are known to utilize polyP confirming the diversity of polyP functions in cells, and they include polyphosphatase, polyP mannokinase and polyP glucokinase (Kornberg, 1995).

PolyP is involved in the mineralization process in bone tissue. Osteoblasts contain higher concentration of polyP and exopolyphosphatase which can release the phosphate required for calcium precipitation during the enzyme process and both respond to modulators of the osteoblasts (Leyhausen, *et al* 1998) PPK is required for adaptation at the onset of amino acid starvation. The adaptation to amino acid starvation is mediated by the network of stringent response and polyP metabolism. PolyP accumulation accompanied by increased levels of strigent factors in response to amino acid starvation was observed in *E.coli* (Kuroda and Ohtake, 2000)

Applications of Polyphosphate

ATP substitute and Energy Source

Polyphosphate kinase (PPK) converts polyP to ATP by catalyzing an ADP attack on the termini of the polyP chain. An aggregate of polyP seen associated with the membrane bound PPK could generate large amount of ATP at that spot. Another source of ATP is from AMP attack an polyP by AMP phospho transferase forming ADP.

AMP phosphotransferase has been purified from *Acinetobacter* (Bonting *et al.*, 1991), in *E.coli* and *Myxococcus xanthus* (Kornberg 1995). In yeast the usual cellular ATP level is 5-10 mM while the massive vacuolar polyP deposits exceeds 200mM and in Myxobacteria cell in stationary phase the granular aggregate can reach upto 50mM. It can also replace ATP in phosphorylation of

glucose by polyP glucokinase which use either ATP or polyP as the donor, a more phylogenetically ancient species showed a preference for polyP over ATP (Hsieh *et al.*, 1993). The ATP regenerating system consisting of ADK, PPK, and polyP was shown to be promising for practical utilization of polyP as ATP substitute (Kornberg, 1995).

Thus in view of its energy equivalence to ATP, polyP qualifies as an ATP substitute in all its kinase roles involving a variety of acceptors and for active transport of nutrients and metabolites across the membranes, indicating the diversity of physiological functions of polyP.

Reservoir for Pi

A stable level of cellular Pi, essential for normal cellular metabolism and growth is insured by a cellular Pi reservoir into which polyP contribute by the action of exopolyphosphatase action (Kornberg, 1995). Cellular polyP as an aggregate, complexed with multivalent counter ion, enjoys a clear osmotic advantage over free orthophosphoric acid, which is highly acidic (Kornberg 1995).

Chelator of metal ions:

PolyP, being a poly anion, is a strong chelator of metal ions. *Lactobacillus plantarum* lacking super oxide dismutase that removes super oxide free radicals has an extra ordinary high level of Mn^{2+} (30mM) chelated to 60mm polyP (Archibald and Fridovich, 1982). In yeast the regulation of cellular Ca^{2+} by vacuolar Ca^{2+} depends on its binding to polyP, which acts as Ca^{2+} sink within the vacuole lumen (Dunn, *et al.*, 1994). Chelation of Ca^{2+} and Mg^{2+} essential for the cell wall structure in Gram +ve bacteria might be the mechanism for antibacterial action of polyP. Chelation of other metals like Zn, Cu, Fe, Cd may either reduce their toxicity or affect their functions (Lee *et al.*, 1994).

Buffer against alkali ions

As in yeast, algae accumulate polyP in vacuoles. The halotolerant green algae *Dunaliella salina*, deposit polyP as high as 1 M in Pi equivalents and when stressed at alkaline pH, amines enter the algal vacuoles and are neutralized by the protons released by the enzymatic hydrolysis of polyP, thus providing a high capacity buffering system protecting the cellular cytoplasmic pH. This algae is cultivated as a food source in large out door ponds (Pick and Weiss, 1991).

Channel for DNA entry

Though the transformation of competent *E.coli* for genetic engineering is a commonly used technique and despite the wide use of Ca^{2+} recipe to induce competence, the mechanism by which

the highly charged DNA penetrates the lipid bilayer cell membrane remains least understood. The discovery of poly hydroxy butyrate (PHB) complex formation with Ca^{2+} and polyP in the competent cell membrane was a significant advance (Reusch and Sadoff, 1988). In a proposed model, the Ca^{2+} is bounded by ion dipoles to the carbonyl ester groups of PHB and by ionic interactions with polyP. This complex might produce profound preferred physical changes in the competent cell membranes, increased rigidity at ambient temperatures and biphasic melting (Reusch and Sadoff, 1988). Whether and how these alterations facilitate DNA entry remains unclear although PPK mutant *E.coli* lacking long chain polyP develop short chain (60 residues) polyP during development of competence (Kornberg, 1995).

Regulator for stress and survival

PolyP readily interacts with basic proteins (eg. Histones) and with basic domains of non histone nuclear proteins (Offenbacher and Kline, 1984). Such interactions can affect gene functions in positive or negative ways. Its presence in several sizes and complex forms in various cellular compartment and location, and fluctuation in response to nutritional and other parameters are suggestive of functions in the network of responses to stress and the many signals that govern stages in cell cycle and development. It might have roles in the multiple metabolic adjustments during the stationary phase of the cell cycle, "life after the log" in *E.coli* in a dynamic interval in which many genes are induced to cope with the environmental stress to ensure survival (Siegele and Kolter, 1992).

PPK mutants lacking long chain polyP showed no phenotypic changes in the exponential phase of growth, while the stationary phase exhibited striking differences and deficiencies (Crooke *et al.*, 1994). The mutant survived less well, less resistant to heat, oxidants and osmotic challenges, and shifts to a small colony phenotype, all of which are suggestive of an adaptive phenotypic change (Harris *et al.*, 1994). Thus polyP may enter in the cascade of events that prepare cells for coping with "life in the slow lane" (Kornberg, 1995). *E. coli* accumulated polyP in response to a nutritional down shift from a rich to a minimum medium (Ault-Rich *et al.*, 1998; Rao *et al.*, 1998).

E.coli mutants lacking PPK and PPX failed to accumulate polyP and exhibited an extended lag phase of growth recovery during the nutritional down shift and the lag was abolished by the introduction of normal PPK gene. This phenomenon was attributed to an impaired adaptation to amino acid starvation, because supplementation of amino acid to the mutant *E.coli* abolished the extended lag and resumed it on removal of amino acid from the medium. The levels of ppGpp

remained high for a longer time in the mutant compared to the transient increase in ppGpp in the wild type, when exposed to nutrient down shift, all indicating *ppk* as important for the rapid recovery from amino acid starvation (Kuroda and Kornberg 1997b, Kuroda et al., 1999). In *E. coli* amino acid starvation induced enzymes for amino acid synthesis, which is necessary for cells to adapt to starvation (Winkler, 1996). Upon starvation and during the stationary phase pppGpp and ppGpp, the stringent factors, elevations preceded polyP increase and induced over 40 enzymes for intracellular protein digestion to generate amino acid required to synthesize essential enzymes for adaptation under down shifted conditions (Yen, 1980).

PPK mutants, defective in polyP failed to increase protein degradation and starvation specific enzyme synthesis leading to sustained increase in ppGpp level, and extended growth lag (Kuroda et al., 1999). ppGpp is important for the accumulation of polyP and plays a direct or indirect role in protein degradation while *ppk-ppx* mutants could not mediate it even in the presence of elevated ppGpp, indicating that polyP could be the direct or indirect mediator of protein degradation (Kuroda et al., 1999). Only little is known about the degradation pathway that is activated in response to nutritional deprivation while PolyP accumulation take place when cells are not actively multiplying i.e., during the lag and stationary phase (Harold, 1963; Lawson and Tonhazy, 1980).

Regulator of Development

During the vegetative growth in *M. xanthus* there is 10-fold increase in polyP and polyP – AMP phosphotransferase activity. PolyP may be an energy source for fruiting bodies, and for deposition in spores when present at concentrations as high as 50mM. During the stationary phase stress response increase in ppGpp precedes polyP formation and mutants that fail to synthesise ppGpp also fail to increase their polyP levels. ppGpp seems to have a regulatory role in polyP formation (Kornberg, 1995). Developmental changes in microbes like- fruiting body and spore formation in *Myxobacteria* sp, sporulation in bacteria (eg: *Bacillus* sp.) and fungi, and heterocyst formation in cyanobacteria (eg: *Anaba* sp.), occur in response to starvation of one or another nutrients and stress, and the stationary phase polyP may be involved in these cellular adjustments to deprivation.

Component of Cell capsule

In *Neisseria* sp almost half of the total cellular polyP occur loosely attached to the cell surface and polyP appears as a component of the cell capsule, and whether this can contribute to pathogenesis of these bacteria is yet to be understood (Tinsley, *et al*, 1993).

Bioremediation

Many studies have observed an apparent relationship between polyP and increased resistance to heavy metals. It has been proposed that cells use polyP to detoxify heavy metals once they have entered the cell (Pettersson, *et al*, 1985). These observations indicate potential application of polyP accumulating microbes towards bioremediation of heavy metal contamination in wastewater. Genetically engineered *P. aeruginosa* expressing a plasmid encoded inducible *ppk* accumulated large quantities of polyP and removed uranyl from solution, forming uranyl phosphate complex deposited on the cell surface. PolyP has been found to be distributed in the periplasmic area and bacterial cell surface in large amount. Metal phosphates are highly insoluble and will precipitate on cell surface (Montgomery, *et al*, 1995).

Marine environment remains almost unexplored with respect to polyP accumulating bacteria except for a few reports. Seawater is rich in cations and these have been reported to increase Pi uptake and stimulation of polyP formation in a variety of microorganisms (Healey, 1982, Van Groenestijn *et al.*, 1988). In the marine *Chromatium* sp. studied polyP / Pi ratio was found to be 2.1 with intracellular Pi content of 0.865 $\mu\text{M}/\text{mg}$ dry weight. The marine *Chromatium* sp. strain was evaluated for the effect of NaCl and sea water on intracellular Pi and polyP. Intracellular phosphate and polyP content increased up to 280mM NaCl and 40-50% seawater was found to be optimum (Hiroaki *et al.*, 1997), while *E.coli* recorded 1.1 and 0.645 respectively (Kato *et al.*, 1993a).

The seawater contains all the elements of the periodic table and it is relatively rich in Pi, Ca, Mg, and Na compared to fresh water, the cations are reported to increase Pi uptake and PolyP accumulation. Moreover accumulation of phosphate is a constant process in the marine environment resulting from the death and decay of the inhabitant plants and animals as well as from the in flowing waters carrying wastes from the land. Marine bacteria are thus exposed to higher Pi concentration in the environment and have become part of the active phosphate cycle of the marine ecosystem. Thus they are expected to have relatively better Pi uptake and polyP accumulation, besides tolerance to osmotic and toxic stress, for probable exploitation in the wastewater treatment.

1.3. Scope of the Present Study

There is absolute dearth of knowledge on phosphate uptake and polyphosphate accumulation by marine microorganisms and there is immense scope for probable industrial application of marine polyphosphate accumulating bacteria in future.

Hence, the present study was carried out with the following major objectives.

- Screening of polyphosphate accumulating bacteria from the sea water and sediments of coastal environments of peninsular South India, both from east of Tamilnadu and west cost of Kerala
- Selection of potential strains that could show impressive phosphate uptake pattern, and polyP accumulation during the course of growth
- Impact of various environmental and nutritional factors on the rate Pi uptake and polyP accumulation

2. MATERIALS AND METHODS

2.1 Sample

Sea water and sediment samples were used as source of samples for screening polyphosphate accumulating bacteria in the present study. Both the samples were collected from the coastal areas of southern part of Kerala State (Arabian Sea) and from coastal area of Rameswaram in Tamil Nadu (Bay of Bengal).

2.2 Collection and transport of Samples

Samples were collected (during January - April 2000), aseptically in sterile containers. Water samples were collected in sterile bottles. Sediment samples were collected using Peterson grab and the middle portion of the sediment collected in the grab was transferred aseptically in to sterile polyethylene bags. Samples were transported in icebox to the laboratory and subjected to microbiological analyses.

2.3. Medium

Zobell's Marine agar (HIMEDIA, India) medium was used for isolation of heterotrophic bacteria present in seawater as well as sediment. The medium was supplemented with 500 μ M phosphate, using KH_2PO_4 (BDH) in addition to the phosphate already available in the readymade medium. Final concentration of phosphate in the medium, after addition of 500 μ M of (KH_2PO_4) was 1800 μ M (after autoclaving).

Zobell's Marine Broth (ZMB) and Zobell's Marine Agar (ZMA) (Hi-Media) were used throughout the course of the study unless otherwise specified. Cultures were stored in Zobell's Marine Agar slopes (with an additional 500 μ M phosphate) at 4° C and sub cultured periodically. Zobell's Marine Broth without additional Pi was used for inoculum preparation, and the same was used with an additional 500 μ M Pi for growth studies.

2.4 Isolation of Heterotrophic bacteria.

The water and sediment samples collected from different locations were plated on Zobell's Marine agar employing pour plate technique, after appropriate serial dilution.

The inoculated plates were incubated at 30°C for 3-5 days. Individual colonies developed on the agar medium were isolated, after recording their morphological characteristics, purified on ZMA plates, and stored at 4°C as slope cultures on Zobell's Marine Agar. Another set of cultures was used as working cultures further screening. All the isolates were subcultured periodically at regular interval of two weeks.

2.5 Screening of the cultures for phosphate uptake, and polyP Accumulation

2.5.1 First phase screening

All the isolates obtained were screened for their ability to uptake inorganic phosphate (Pi) from environment, and accumulate the phosphate as polyP in the cell. This screening was done in two phases.

First phase of screening included evaluation of all the isolates obtained for Pi uptake and polyP accumulation after 24 hours of growth.

2.5.1.1 Inoculum preparation:

A loopful of 24hrs. Agar slope culture was inoculated into 5ml of Zobell's Marine Broth (HIMEDIA), without any additional phosphate in the medium and incubated at room temperature ($28 \pm 2^\circ\text{C}$) and at 120 rpm for 18 hrs.

2.5.1.2 Inoculation and Incubation

After 18 hrs of incubation, 0.5ml of the culture broth was transferred into a 50ml of fresh Zobell's Marine broth in a 250 ml conical flask (1% inoculum v/v) which was prepared with an additional 500µM phosphate (Pi) in the medium. After inoculation, the flasks were incubated at room temperature ($28 \pm 2^\circ\text{C}$) at 120 rpm for 24 hrs. After growth the culture broth was used for all assays.

2.5.1.3 Assay

One ml of the culture broth was centrifuged at 10,000 rpm at 4°C, for 10 min. The supernatant was used for estimation of the residual phosphate in the medium and the cell pellet was used for polyphosphate and free inorganic phosphate in the cells.

2.5.1.3.1 Estimation of various Phosphates

The residual phosphate remained in the spent broth was estimated following the Ascorbic acid method described by Kato *et al* (1993). The intracellular phosphates were estimated based on the method of Harold (1966). The cell pellet obtained was resuspended in one ml of 10% ice-cold TCA solution and allowed to stand for 30 min, after mixing well by vortexing the contents. Later, the contents were centrifuged at 15,000 rpm for 10 min. at 4°C. The supernatant was collected and used for estimation of free inorganic phosphate in the cell. The pellet was resuspended in 1 ml of 1N HCl, vortexed, boiled for 7 min., cooled rapidly in cold water, centrifuged at 15000 rpm at 4°C for 10 min., and the Pi in the supernatant was estimated as polyP.

2.5.1.3.2 Total Cellular Protein

Biomass was estimated in terms of total cell protein. One ml of the sample was centrifuged at 10000 rpm for 10 min., (at 4°C) and the total protein of the sedimented cell pellet was estimated by the modified Lowry's method described by Herbert *et al* (1971).

2.5.2 Second Phase Screening

Based on the results obtained during First phase screening, the potential strains were ranked according to their Pi uptake capacity. 26 isolates, representing different locations of sampling and both water and sediment, were selected and subjected to second phase screening towards selection of potential strains.

All the selected isolates were evaluated for their efficiency for Pi uptake from medium, accumulation of cellular free Pi, polyP, Low Molecular Weight phosphates(ATP, ADP etc.), and the Nucleic acid phosphates in their cells during growth. Different phosphates were estimated at regular intervals up to 7 days. Biomass was also estimated in terms of total cell protein.

Inoculum for each selected culture was prepared as mentioned in the previous section. From the pre-culture prepared one ml was drawn and transferred into 100 ml of freshly prepared ZMB added with Pi (500µM) and incubated at room temperature (28±2°C), 120 rpm, for a total period of 7 days. Samples were drawn at regular intervals and the samples were analysed for (i) Total cell protein (ii) Residual phosphate in the medium for computing phosphate uptake, (iii) Cellular free inorganic Pi, (iv) Low Molecular weight phosphates (v) Polyphosphate and (vi) Nucleic acid phosphate (all estimated as inorganic phosphate Pi).

2.5.2.1 Total cell protein:

Total cell protein was estimated in 0.5ml of the broth. The sample was centrifuged at 10000 rpm at 4°C for 10 min. The pellet was re-suspended in 0.5 ml of 1N NaOH, boiled for 5 min., and the protein was estimated using the method explained by Herbert *et al* (1971).

2.5.2.2. Estimation of the phosphates

One ml of the culture was centrifuged at 10000 rpm, the supernatant was used for estimating the residual Pi using the Ascorbic acid method of Kato *et al* (1993) and the pellet was used to estimate the various intracellular phosphates based on the method of Harold *et al* (1966). All forms of phosphates were ultimately estimated as Pi using the Ascorbic acid method.

1. The pellet was re-suspended in 1ml 10% ice-cold TCA, vortexed, centrifuged at 15000 rpm. for 10 min.
2. 0.5 ml of the supernatant was used directly for Pi estimation as the cellular free Pi
3. The balance 0.5 ml of the supernatant was added with 1ml 5N sulfuric acid and a pinch of ammonium peroxodisulphate, autoclaved for 30min. and estimated Pi as the low MW phosphates.
4. The cell pellet was added with 1ml 1N HCl, boiled for 7min, centrifuged at 15000 rpm, for 10 min. and the supernatant was estimated for Pi as the polyphosphate.
5. The pellet was further added with 1 ml 5N sulfuric acid and a pinch of ammonium peroxodisulphate, autoclaved for 30min and estimated for Pi as the nucleic acid phosphate.

2.6 Identification of Bacteria

All the 26 isolates, selected based on their performance during the First phase screening and subjected to Second phase screening towards selection of potential strains for further study, were identified up to their generic level. Morphology of colony and cell, biochemical characteristics and physiological characteristics of the isolates were studied and based on the schemes suggested by the Bergy's Manual of Determinative Bacteriology (1980) the cultures were assigned to various genera. No attempt was made to identify them up to their species level.

2.7 Selection of Potential Strains for further studies

Performance in terms of active phosphate uptake and release of Pi into the medium during their active growth, accumulation of inorganic phosphate as polyphosphate and various other forms

of phosphates during growth over 7 days of incubation, was evaluated for all the 26 cultures tested. Based on the results, two cultures were selected finally for further studies.

2.8 Impact of different conc. of phosphate in the medium on Pi uptake and polyphosphate accumulation by marine bacteria.

2.8.1. Medium

Zobell's Marine Broth (ZMB) (HI Media, India) was used throughout the study in order to have consistent and reproducible results besides providing otherwise optimal conditions for the growth of the selected marine bacteria. The medium was prepared by dissolving the dehydrated readymade medium in de-ionized water (DIW) and used after sterilization by autoclaving.

This ZMB was used as the basal medium and to this phosphate (KH_2PO_4) was added at different concentrations, in addition to the phosphate already present in the medium. Various levels of phosphate conc. in the medium tested included (1) 500 μM Pi (2) 3000 μM (3) 6000 μM (4) 9,000 μM (5) 12, 000 μM . ZMB without any additional Pi was considered as control, since the medium contain 1432 μM Pi (SD 12).

2.8.2 Inoculum preparation

A pre-culture of the selected strain was prepared first by inoculating 5 ml of Zobell's Marine Broth with a loopfull culture of 18 hrs. old ZM Agar slope culture and incubated for 18 hrs. in an orbital shaker at 120 rpm, at room temperature ($28 \pm 2^\circ\text{C}$). Later, using this pre culture, 50 ml of freshly prepared ZMB was inoculated at 1%(v/v) level and incubated at room temperature ($28 \pm 2^\circ\text{C}$) on an orbital shaker at 120 rpm for further period of 18 hrs. The culture broth obtained was centrifuged at 10,000 rpm, at 4°C for, 10 min. under sterile conditions, and the cells were harvested. Cell pellet was washed in physiological saline and suspended in the same. The prepared cell suspension (10 ml) was used as inoculum at 1%(v/v) level in all the subsequent experiments.

2.8.3 Inoculation and Incubation

Media prepared, in 100 ml aliquots, with different conc. of phosphates, were inoculated with the prepared inoculum at 1% (v/v) level, and incubated at room temperature ($28 \pm 2^\circ\text{C}$) (unless otherwise mentioned), on an orbital shaker at 120 rpm for a total period of 48 hrs. After incubation for the specified period, the culture broth was used for various assays.

2.8.4 Estimation of Biomass and Phosphates

Samples were drawn at 0, 1, 4, 8, 12, 20, 28, 36, and 48 hrs. of growth aseptically and subjected to analyses which was done in triplicate. The total cell protein, and Residual Pi and polyP were estimated as mentioned earlier, respectively, under sections 2.5.2.1. and 2.5.2.2.

2.9. Impact of pH on Pi uptake and polyP accumulation by marine bacteria

Impact of pH of the cultivation medium on the rate of inorganic phosphate (Pi) uptake from the medium and polyphosphate accumulation by both marine *Vibrio* sp and *Achromobacter* sp was studied in ZoBell's Marine broth (ZMB) adjusted to various levels of pH varying between 2 to 12, using 1 N NaOH and 1 N HCl. ZMB prepared in de-ionized water had a pH of 7.3 and this was considered as control for comparison purposes.

Preparation of inoculum (section 2.8.2), inoculation and incubation(section 2.8.3), and estimation of biomass(2.5.2.1), residual Pi in the medium and polyphosphate in the cells(section 2.5.2.2) of the samples drawn at regular intervals (section 2.8.4)were all performed as mentioned earlier.

2.10 Impact of Incubation Temperature on Pi uptake and polyP accumulation by Marine bacteria

Impact of incubation temperature on the rate of inorganic phosphate (Pi) uptake from the medium and polyphosphate accumulation by both marine *Vibrio* sp and *Achromobacter* sp was studied in ZoBell's Marine broth (ZMB) at different incubation temperatures (RT($28 \pm 2^{\circ}\text{C}$), 35, 40, 45, 50 and 55°C .).

Preparation of inoculum(section 2.8.2), inoculation and incubation(section 2.8.3), and estimation of biomass(2.5.2.1), residual Pi in the medium and polyphosphate in the cells(section 2.5.2.2) of the samples drawn at regular intervals(section 2.8.4) were all performed as mentioned earlier.

2.11 Impact of Additional Sodium chloride concentration in the medium on Pi Uptake and polyP accumulation by marine bacteria

Impact of NaCl in the cultivation medium on the rate of inorganic phosphate (Pi) uptake from the medium and polyphosphate accumulation by both marine *Vibrio* sp and *Achromobacter* sp was studied in ZoBell's Marine broth (ZMB) medium adjusted to various levels of NaCl (0.5M,

0.7M, 0.9M, and 1.1M). The ZMB without additional NaCl was used as the control, since the medium already contained 0.33 M NaCl.

Preparation of inoculum(section 2.8.2), inoculation and incubation(section 2.8.3), and estimation of biomass(2.5.2.1), residual Pi in the medium and polyphosphate in the cells(section 2.5.2.2) of the samples drawn at regular intervals (section 2.8.4)were all performed as mentioned earlier.

2.12. Effect of other additional inorganic salts in the medium on Pi uptake and polyP accumulation by marine bacteria

2.12.1. KCl

Impact of KCl in the cultivation medium on the rate of inorganic phosphate uptake from the medium and polyphosphate accumulation by both marine *Vibrio* sp and *Achromobacter* sp was studied in ZoBell's Marine broth (ZMB) medium adjusted to various levels of KCl (i) 0.014 M (ii) 0.021 M (iii) 0.028 M (iv) 0.035 M). The ZMB without additional KCl was used as the control, since the medium already contained 0.007M KCl.

Preparation of inoculum(section 2.8.2), inoculation and incubation(section 2.8.3), and estimation of biomass(2.5.2.1), residual Pi in the medium and polyphosphate in the cells(section 2.5.2.2) of the samples drawn at regular intervals(section 2.8.4) were all performed as mentioned earlier.

2.12.2 CaCl₂

Impact of CaCl₂ in the cultivation medium on the rate of inorganic phosphate uptake from the medium and polyphosphate accumulation by both marine *Vibrio* sp and *Achromobacter* sp was studied in ZoBell's Marine broth (ZMB) medium adjusted to various levels of KCl (0.03 M, 0.05 M, 0.07 M, 0.09 M). The ZMB without additional CaCl₂ was used as the control, since the medium already contained 0.016 M CaCl₂.

Preparation of inoculum(section 2.8.2), inoculation and incubation(section 2.8.3), and estimation of biomass(2.5.2.1), residual Pi in the medium and polyphosphate in the cells(section 2.5.2.2) of the samples drawn at regular intervals(section 2.8.4) were all performed as mentioned earlier.

2.12.3 MgSO₄

Impact of MgSO₄ in the cultivation medium on the rate of inorganic phosphate uptake from the medium and polyphosphate accumulation by both marine *Vibrio* sp and *Achromobacter* sp was studied in ZoBell's Marine broth (ZMB) medium adjusted to various levels of MgSO₄. (0.1 M, 0.2 M, 0.3 M and 0.4 M). The ZMB without additional MgSO₄ was used as the control, since the medium already contained 0.073M MgSO₄

Preparation of inoculum(section 2.8.2), inoculation and incubation(section 2.8.3), and estimation of biomass(2.5.2.1), residual Pi in the medium and polyphosphate in the cells(section 2.5.2.2) of the samples drawn at regular intervals(section 2.8.4) were all performed as mentioned earlier.

2.12.4 Sodium Citrate

Impact of sodium citrate in the cultivation medium on the rate of inorganic phosphate uptake from the medium and polyphosphate accumulation by both marine *Vibrio* sp and *Achromobacter* sp was studied in ZoBell's Marine broth (ZMB) medium adjusted to various levels using trisodium citrate (0.01 M, 0.02 M, 0.03 M, 0.04 M sodium citrate). The ZMB without additional trisodium citrate was used as the control, since the medium already contained 0.007 M Ferric citrate.

Preparation of inoculum(section 2.8.2), inoculation and incubation(section 2.8.3), and estimation of biomass(2.5.2.1), residual Pi in the medium and polyphosphate in the cells(section 2.5.2.2) of the samples drawn at regular intervals(section 2.8.4) were all performed as mentioned earlier.

2.12.5. Ammonium Nitrate

Impact of ammonium nitrate in the cultivation medium on the rate of inorganic phosphate uptake from the medium and polyphosphate accumulation by both marine *Vibrio* sp and *Achromobacter* sp was studied in ZoBell's Marine broth (ZMB) medium adjusted to various levels of ammonium nitrate (0.005 M, 0.01 M, 0.02 M and 0.03 M). The ZMB without additional ammonium nitrate was used as the control, since the medium already contained 0.002 M ammonium nitrate.

Preparation of inoculum(section 2.8.2), inoculation and incubation(section 2.8.3), and estimation of biomass(2.5.2.1), residual Pi in the medium and polyphosphate in the cells(section 2.5.2.2) of the samples drawn at regular intervals(section 2.8.4) were all performed as mentioned earlier.

2.13 Effect of other additional organic carbon sources in the medium on Pi uptake and polyP accumulation by marine bacteria

2.13.1. Peptone

Impact of peptone in the cultivation medium on the rate of inorganic phosphate uptake from the medium and polyphosphate accumulation by both marine *Vibrio* sp and *Achromobacter* sp was studied in ZoBell's Marine broth (ZMB) adjusted to various levels of peptone (1%, 2%, 3% and 4% w/v). The ZMB without additional peptone was used as the control, since the medium already contained 0.5% peptone (w/v).

Preparation of inoculum(section 2.8.2), inoculation and incubation(section 2.8.3), and estimation of biomass(2.5.2.1), residual Pi in the medium and polyphosphate in the cells(section 2.5.2.2) of the samples drawn at regular intervals(section 2.8.4) were performed as mentioned earlier.

2.13.2 Yeast Extract

Impact of yeast extract in the cultivation medium on the rate of inorganic phosphate uptake from the medium and polyphosphate accumulation by both marine *Vibrio* sp and *Achromobacter* sp was studied in ZoBell's Marine broth (ZMB) medium adjusted to various levels of yeast extract (0.2%, 0.4%, 0.8%, 1.6% w/v). The ZMB without additional yeast extract was used as the control, since the medium already contained 0.1% yeast extract.

Preparation of inoculum(section 2.8.2), inoculation and incubation(section 2.8.3), and estimation of biomass(2.5.2.1), residual Pi in the medium and polyphosphate in the cells(section 2.5.2.2) of the samples drawn at regular intervals (section 2.8.4) were all performed as mentioned earlier.

2.13.3 Glucose

Impact of Glucose in the cultivation medium on the rate of inorganic phosphate uptake from the medium and polyphosphate accumulation by both marine *Vibrio* sp and *Achromobacter* sp was

studied in ZoBell's Marine broth (ZMB) medium adjusted to various levels of Glucose (0.05 M, 0.10M, 0.2 M) and added with 500 μ M Pi (K H₂PO₄) for each concentration of Glucose and for each culture, in order to understand the inhibitory effect of glucose on Pi uptake. The ZMB without additional Glucose was used as the control.

Preparation of inoculum(section 2.8.2), inoculation and incubation(section 2.8.3), and estimation of biomass(2.5.2.1), residual Pi in the medium and polyphosphate in the cells(section 2.5.2.2) of the samples drawn at regular intervals (section 2.8.4) were all performed as mentioned earlier.

Residual Glucose in the medium was estimated by the Glucose Oxidase/Peroxidase (GOD/POD) Method(AUTOPAK, GLUC, Bayer Diagnostics India Ltd)

2.14 Statistical analyses

Standard deviation, and Mean were calculated using Microsoft Excel programme.

3. RESULTS

3.1 Screening of polyphosphate accumulating bacteria from marine environments

3.1.1 First Phase Screening

During the First phase of screening of polyphosphate accumulating bacteria, 540 isolates were obtained from seawater (340) and marine sediment (200) collected from the coastal environments of Kerala and Tamil Nadu. Almost 80% of the isolates, from both sea water and marine sediment recorded biomass in the range of 400-700 $\mu\text{g} / \text{ml}$, during growth in Zobell's Marine broth after 24 hrs. About 66% of the isolates obtained from sea water recorded biomass above the level of $>700 \mu\text{g/ml}$ compared to 56% the marine sediment counterpart, which recorded biomass in the range of 400-700 $\mu\text{g/ml}$.

All the isolates were evaluated for their efficiency to uptake inorganic phosphate from the medium and accumulate Pi as polyphosphate(polyP). Results presented in **Fig.1** indicated that the lowest Pi uptake recorded was 86% against the maximum of 97.8%, after 24 hrs. of incubation. More than 95% of the isolates, from both water and sediment, showed 90-95% phosphate uptake by 24 hrs. The sediment isolates showed high efficiency to remove Pi above 94%. Nevertheless, in general, more than 85% isolates, from both water and sediment, recorded residual Pi in the range of 60-150 μM after 24hrs. compared to 1800 μM of Pi at 0hr. Interestingly, isolates obtained from the marine sediment of Cochin coast recorded the highest Pi uptake compared to that of other areas.

Among the 540 isolates, obtained from seawater and marine sediment, tested for their efficiency to uptake Pi from the medium into the cell, more than 95% of the isolates recorded cellular free Pi at concentrations in the range of 120-250 μM (Fig.2). It is evident from the data presented in Fig. 2 that about 50% of the isolates obtained from the sediments could record maximal Pi as cellular free Pi (200-250 μM) compared to the isolates of sea water (20%).

Majority of the marine bacterial isolates, irrespective of their source of isolation whether sea water or sediment, accumulated polyP up to $>35 \mu\text{g/mg}$ cell protein in their cells (Fig.3).

However, only about 60% of the isolates could record 11-20 μg of polyP/ mg cell protein. Relatively, isolates obtained from sea water were capable of accumulating enhanced levels of polyP compared to that of marine sediments.

Fig.1 Percent removal of inorganic phosphate(Pi) by marine bacteria isolated from sea water and marine sediment during growth Zobell's marine broth(Initial Pi concentration in the medium-1800 μ M)

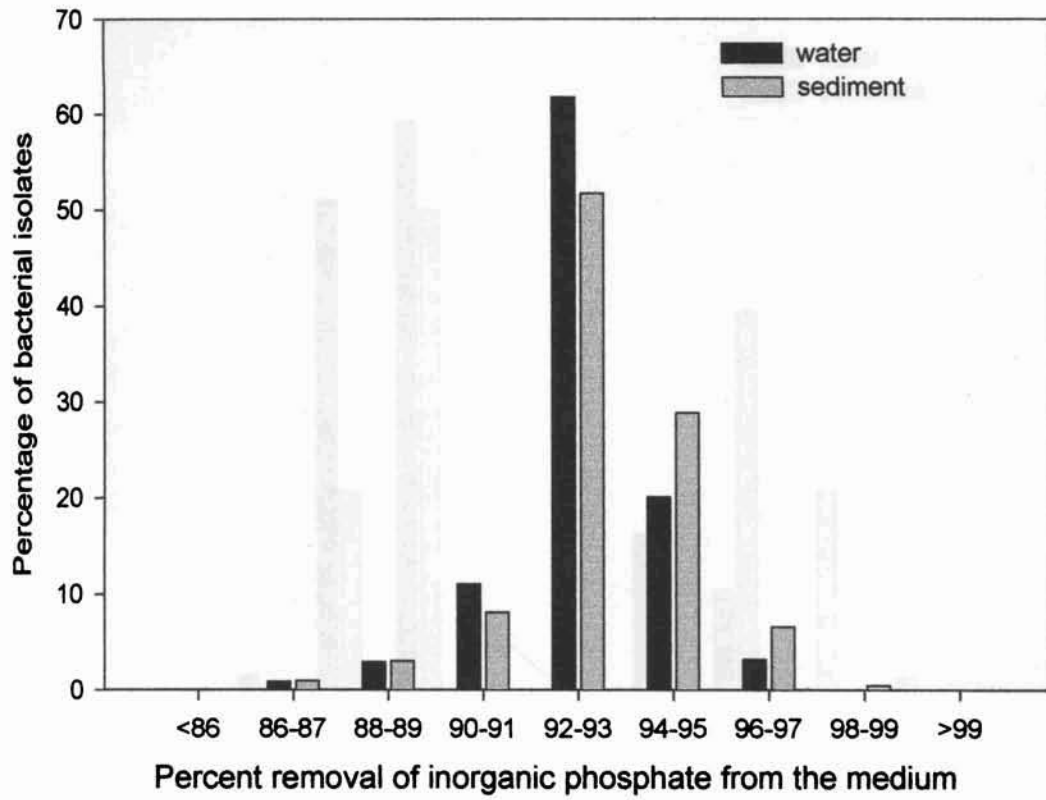

Fig. 2 Concentration of cellular free inorganic phosphate(Pi)in the cells of marine bacteria isolated from sea water and marine sediment during growth in Zobell's marine broth (Initial concentration of Pi in the medium-1800 μ M)

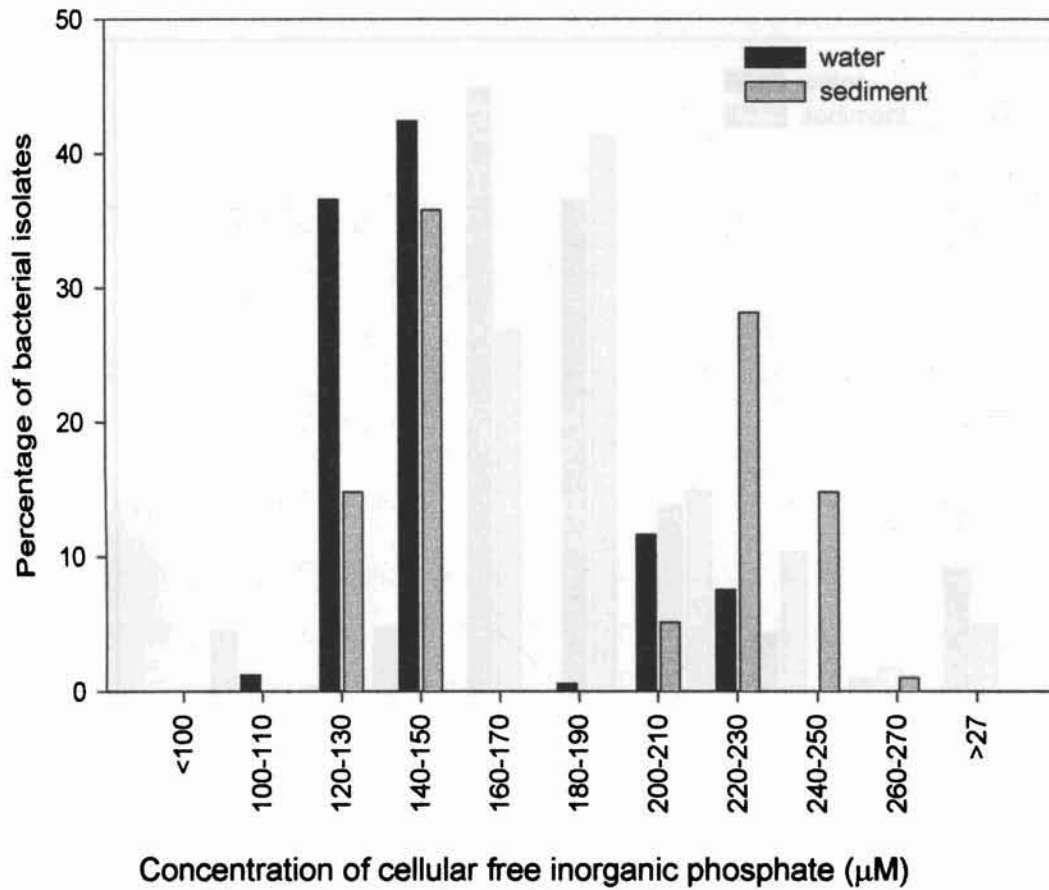
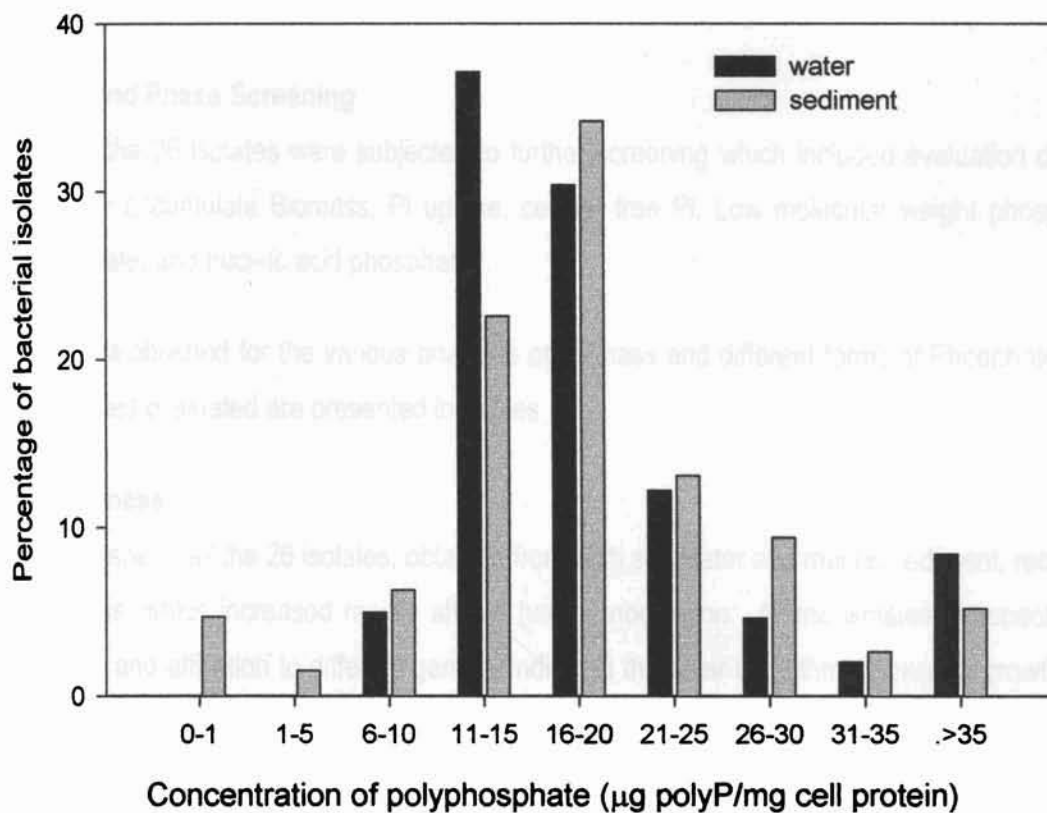

Fig. 3 Polyphosphate accumulation by marine bacteria isolated from sea water and marine sediment during growth in Zobell's marine broth (initial concentration of Pi in the medium-1800 μ M)



3.1.2 Identification of Short listed Isolates

During the **second phase** of screening of potential strains for polyP accumulation, 26 isolates were short listed based on their efficiency to uptake phosphate from the medium and release them into environment besides accumulating polyP in the cells, evaluated during the preliminary screening conducted as under first phase.

All the short listed 26 isoaltes were **identified up to their generic level** as mentioned under the Materials and Methods section. They mainly included species of *Pseudomonas*, *Vibrio*, *Acinetobacter*, *Enterobacteriaceae*, *Achromobacter*, *Arthrobacter* and *Staphylococci*

3.1.3. Second Phase Screening

All the 26 isolates were subjected to further screening which included evaluation of their efficiency to accumulate Biomass, Pi uptake, cellular free Pi, Low molecular weight phosphate, polyphosphate, and nucleic acid phosphates.

Data obtained for the various analyses of biomass and different forms of Phosphates for the 26 isolates evaluated are presented in Tables 1-12.

3.1.3.1 Biomass

In general all the 26 isolates, obtained from both sea water and marine sediment, recorded high biomass, which increased rapidly after 4 hrs. of inoculation. All the isolates, irrespective of their source and affiliation to different genera, indicated that their logarithmic phase of growth was during 4-8 hrs. (**Table 1**). However, maximal biomass was recorded after 24 hrs. for the species of *Vibrio*, *Staphylococci*, *Acinetobacter* and the *Enterobacteriaceae* sp isolated from the marine sediment, while species of *Pseudomonas*, *Arthrobacter* and *Enterobacteriaceae* isolated from the sea water recorded maximal biomass after 40 hrs. Species of *Arthrobacter* showed almost a similar level of biomass (0.79 mg protein/ml to 0.8 mg protein/ml) during 16-64 hrs. The maximal biomass varied from 0.96 mg protein/ml to 1.462 mg protein/ml for the various strains.

All the isolates obtained from sea water recorded increase in biomass till 24 hrs. During later period of incubation the biomass declined. From the results presented in Table 2, it is evident that active logarithmic phase of growth for the isolates of sea water was during 4-8 hrs, when the biomass increased from 0.315(SD 0.08) to 0.85 (SD 0.1) mg cell protein/ml. However, there was increase in biomass during 8-24 hrs, indicating late exponential phase. Maximal biomass(1.219, (SD 0.22), mg cell protein/ml) was recorded at 24 hrs.

Table 1

Biomass of different genera of bacteria isolated from marine environments of Kerala and Tamilnadu

Incubation period (Hrs)	Biomass (Cell protein mg/ml)								
	Water					Sediment			
	<i>Vib</i>	<i>Ent</i>	<i>Pse</i>	<i>Art</i>	<i>Staph</i>	<i>Vib</i>	<i>Ent</i>	<i>Aci</i>	<i>Ach</i>
1	0.01 (0)	0.01 (0.002)	0.05 (0)	0.09 (0)	0.01 (0)	0.01 (0)	0.01 (0)	0.12 (0)	0.01 (0)
2	0.13 (0.05)	0.15 (0.06)	0.16 (0)	0.13 (0)	0.09 (0.06)	0.17 (0.05)	0.12 (0.07)	0.07 (0)	0.14 (0)
4	0.34 (0.05)	0.34 (0.11)	0.25 (0)	0.34 (0)	0.21 (0)	0.37 (0.07)	0.34 (0.10)	0.17 (0)	0.26 (0)
8	0.94 (0.04)	0.81 (0.11)	0.87 (0)	0.83 (0)	0.78 (0.03)	0.99 (0.05)	0.89 (0.18)	0.77 (0)	0.66 (0)
16	1.20 (0.03)	1.09 (0.16)	1.1 (0)	1.03 (0)	0.93 (0.01)	1.27 (0.16)	1.11 (0.15)	1.01 (0)	0.79 (0)
24	1.39 (0.27)	1.13 (0.17)	1.2 (0)	1.28 (0)	1.01 (0.02)	1.46 (0.13)	1.34 (0.19)	1.16 (0)	0.77 (0)
40	1.28 (0.19)	1.14 (0.20)	1.22 (0)	1.30 (0)	0.97 (0.01)	1.46 (0.11)	1.24 (0.21)	1.14 (0)	0.72 (0)
64	1.22 (0.12)	1.12 (0.27)	1.13 (0)	1.24 (0)	0.98 (0.01)	1.38 (0.22)	1.21 (0.36)	1.18 (0)	0.80 (0)
168	1.07 (0.22)	1.01 (0.16)	1.00 (0)	1.20 (0)	1.01 (0.06)	1.21 (0.20)	1.13 (0.40)	1.13 (0)	0.96 (0)

(Standard deviation in brackets)

Vib - *Vibrio sp*
Ent - *Enterobacteriaceae sp*
Pse - *Pseudomonas sp*
Art - *Arthrobacter sp*
Sta - *Staphylococci sp*
Aci - *Acinetobacter sp*
Ach - *Achromobacter sp*

Table 2

Biomass of Gram Positive and Gram Negative bacteria isolated from marine environments of Kerala and Tamilnadu

Incubation Period (Hrs)	Biomass (Cell protein (mg/ml))			
	Water	Sediment	Gram -ve	Gram+ve
1	0.02 (0.02)	0.01 (0)	0.01 (0.01)	0.03 (0.04)
2	0.14 (0.05)	0.13 (0.06)	0.14 (0.05)	0.10 (0.05)
4	0.32 (0.08)	0.29 (0.10)	0.32 (0)	0.24 (0.06)
8	0.85 (0.10)	0.87 (0.14)	0.87 (0.12)	0.79 (0.04)
16	1.11 (0.12)	1.09 (0.19)	1.12 (0.16)	0.95 (0.04)
24	1.22 (0.22)	1.24 (0.25)	1.26 (0.23)	1.08 (0.13)
40	1.18 (0.20)	1.21 (0.26)	1.22 (0.23)	1.05 (0.16)
64	1.14 (0.21)	1.19 (0.28)	1.19 (0.25)	1.04 (0.13)
168	1.04 (0.21)	1.12 (0.26)	1.08 (0.25)	1.06 (0.1)

(Standard deviation in brackets)

All the isolates of marine sediment similar to that of sea water isolates, recorded active logarithmic phase during 4-8 hrs and maximal biomass (0.01 – 1.26 mg cell protein/ml). Gram -ve strains recorded higher biomass (0.01 – 1.26 mg cell protein/ml) compared to Gram +ve (0.029 – 1.07 mg cell protein/ml).

3.1.3. 2 Phosphate Removal

A considerable amount of inorganic Pi from the environment in the range of 33.82- 56.19% was removed by the isolates by the end of one hour of growth in the medium (Table 3). Both *Staphylococci sp* and *Achromobacter sp.* could effect >50% of Pi removal from the medium compared to other species at the end of 4 hrs. of growth, after which the isolates entered into their logarithmic phase of growth. All the isolates could effect almost >60% of Pi removal except *Achromobacter Sp.* which recorded only 57.03% Pi removal. On the other hand, *Arthrobacter sp.* recorded 78.9% Pi removal. Very interestingly, invariably, all the isolates recorded a decline in the percent of Pi removal, after 8 hrs. from the level recorded at 4 hrs. In fact 4-8 hrs. was observed as logarithmic phase and there was Pi release into the medium resulting in a decline in % Pi removal. However, later, there was steady increase in the rate of % of Pi removal during the stationery phase of growth for all the isolates. Except *Achromobacter sp.* (71.8%) and *Acinetobacter sp.* (92.15%), all the other isolates tested removed a maximum of 98.8-100% of Pi from the medium by 64 hrs of growth. Species of *Vibrio* isolated from marine sediments removed Pi at a higher rate compared to seawater isolates.

A rapid removal of 47.11% of Pi from the medium was recorded during the first hour of growth, for the sea water isolates compared to 41.58% of Pi removal by the sediment isolates (Table 4). However, both the isolates of sea water and sediments showed identical trend of a marginal decrease in the % of Pi removal indicating a marginal release of Pi into the medium at 2 hrs. This was followed by a rapid removal of Pi during 2-4 hrs marked by sudden increase in the % of Pi removal at 4 hrs (63.36% and 62.0% respectively for sea water and sediment isolates). The period of incubation, 4-8 hrs, considered as logarithmic phase witnessed a decline in the percent removal of Pi indicating release of Pi into the medium. Nevertheless, the percent of Pi removal recorded a continuous increase during the period of 8-64 hrs reaching a maximum at 64 hrs (99.23% and 96.27% respectively for sea water and sediment isolates). While Gram -ve isolates recorded an identical pattern of increase and decrease in percent removal, very much like that of sea water and sediment indicates, Gram +ve isolates recorded continuous increase in %Pi removal throughout the course of growth, except at 8 hrs, and on 7th day when there was a marginal

Table 3

Phosphate removal by different genera of bacteria isolated from marine environments of Kerala and Tamilnadu

Incubation period (Hrs)	% Phosphate removal								
	Water					Sediment			
	<i>Vib</i>	<i>Ent</i>	<i>Pse</i>	<i>Art</i>	<i>Staph</i>	<i>Vib</i>	<i>Ene</i>	<i>Aci</i>	<i>Ach</i>
1	42.92 (8.63)	47.87 (10.06)	46.25 (0)	48.40 (0)	56.19 (5.06)	33.82 (5.27)	40.30 (5.86)	41.21 (0)	51.50 (0)
2	34.75 (16)	47.23 (12.7)	48.80 (0)	72.20 (0)	51.63 (6.01)	30.20 (14.74)	45.63 (14.83)	39.05 (0)	53.10 (0)
4	60.32 (14.47)	60.64 (3.96)	69.90 (0)	78.90 (0)	60.90 (3.08)	63.12 (6.09)	63.77 (23.32)	61.85 (0)	57.03 (0)
8	53.20 (7.80)	53.84 (12.44)	61.25 (0)	60.50 (0)	64.43 (2.02)	61.41 (10.46)	49.45 (18.31)	46.65 (0)	54.20 (0)
16	68.54 (7.18)	75.08 (16.29)	81.60 (0)	72.60 (0)	86.13 (1.56)	73.69 (7.66)	68.43 (23.33)	63.60 (0)	53.12 (0)
24	80.24 (4.59)	81.73 (11.71)	86.30 (0)	80.40 (0)	93.16 (0.83)	80.04 (2.77)	80.43 (16.22)	74.95 (0)	55.07 (0)
40	96.96 (4.29)	97.83 (2.91)	100 (0)	97.20 (0)	97.46 (1.84)	94.77 (5.18)	95.54 (4.64)	82.15 (0)	46.40 (0)
64	98.80 (1.52)	99.40 (1)	100 (0)	99.60 (0)	99.08 (0.98)	100 (0)	100 (0)	92.15 (0)	71.80 (0)
168	99.60 (0.8)	98.81 (2.07)	100 (0)	100 (0)	97.24 (2.06)	100 (0)	100 (0)	94.10 (0)	69.50 (0)

(Standard deviation in brackets)

- Vib* - *Vibrio sp*
Ent - *Enterobacteriaceae sp*
Pse - *Pseudomonas sp*
Art - *Arthrobacter sp*
Sta - *Staphylococci sp*
Aci - *Acinetobacter sp*
Ach - *Achromobacter sp*

Table 4

Phosphate removal by Gram Positive and Gram Negative bacteria isolated from marine environments of Kerala and Tamilnadu

Incubation Period (Hrs)	% Phosphate removal			
	Water	Sediment	Gram -ve	Gram +ve
1	47.11 (12.2)	41.58 (8.84)	42.79 (10.81)	54.24 (5.68)
2	46.45 (17.24)	40.46 (13.4)	41.31 (15.23)	56.77 (11.39)
4	63.36 (10.33)	62.00 13.51	62.25 (12.17)	65.4 (9.34)
8	55.78 (9.33)	56.05 (12.7)	54.54 (11.2)	63.45 (2.56)
16	74.74 (12.06)	71.07 (14.34)	71.28 (13.19)	82.75 (6.88)
24	82.63 (8.58)	79.45 (12.0)	79.56 (10.04)	89.97 (6.41)
40	97.97 (2.95)	89.10 (15.47)	93.23 (12.32)	97.4 (1.51)
64	99.23 (1.09)	96.27 (8.28)	97.62 (6.23)	99.21 (0.84)
168	99.01 (1.86)	96.21 (8.7)	97.68 (6.59)	97.9 (2.17)

(Standard deviation in brackets)

reduction in % of Pi removal (Table 4). Further Gram +ve strains recorded enhanced levels of % Pi removal compared to Gram -ve isolates right from the early phases of growth.

3.1.3.3 Cellular free Pi

All the isolates tested could record considerable level of Pi as cellular free Pi fraction during growth (Table 5). After 1 hr. of growth in the medium, the cellular free Pi conc. varied from 845 μM . (*Acinetobacter* sp) to 1143 μM . (*Arthrobacter* sp). These levels drastically got declined to a range of 463 (*Pseudomonas* sp) – 675.23 (*Enterobacteriaceae*) after 4 hrs. However, there was an increase in the cellular free Pi level during the subsequent incubation period, in spite of fluctuation at 16 hrs. for all the isolates. Species of *Staphylococci*, *Acinetobacter* and *Enterobacteriaceae* isolated from sea water recorded an increase in Pi level at 2 hrs followed by a rapid decrease at 4 hrs., unlike that of other species in which Pi declined gradually during 1-4 hrs. Further, except species of *Arthrobacter* and *Achromobacter* which showed a reduction in cellular free Pi at 40 hrs., all the isolates of other species tested showed progressive increase in cellular free Pi during the incubation period of 24 hrs. to 7 days. However, maximal level of cellular free Pi was recorded in the range of 1129-1468 μM after 64 hrs.

Isolates obtained from seawater and sediment recorded very similar levels of free Pi in the cells (Table 6). Thus all the isolates recorded a gradual decrease in the conc. of cellular free Pi during 1-4 hrs, after recording a high level of Pi at 1 hr. However, the cellular free Pi level increased later continuously throughout the period of growth except for the decrease recorded at 16 hrs. Interestingly, increase in cellular free Pi level coincided with the logarithmic and stationery phases of growth. In general, the cellular free Pi level varied from 636.07 to 1354.57 μM and 575.58 to 1391.83 μM respectively for seawater and sediment isolates. Gram -ve isolates showed a trend similar to that of water and sediment isolates, whereas Gram +ve isolates recorded alternating increase and decrease, and consequent fluctuation in the levels of cellular free Pi during the course of growth (Table 6).

3.1.3.4 Low Molecular Weight Phosphates

Irrespective of the source, all the isolates tested invariably showed fluctuation, in terms of decrease and increase alternatively, in the level of Low molecular weight phosphates in the cells during the course of growth (Table 7). Nevertheless, all the isolates irrespective of their affiliation, recorded a rapid decline in the phosphate level during logarithmic phase of growth (4-8 hrs.) followed by a raise in phosphate level at 16 hrs.

Table 5

Cellular free phosphate accumulation by different genera of bacteria isolated from marine environments of Kerala and Tamilnadu

Incubation period (Hrs)	Cellular free phosphate (μM)								
	Water					Sediment			
	<i>Vib</i>	<i>Ent</i>	<i>Pse</i>	<i>Art</i>	<i>Staph</i>	<i>Vib</i>	<i>Ene</i>	<i>Acn</i>	<i>Ach</i>
1	857.75 (92.93)	860.33 (88.56)	975	1143	890.66 (195.4)	922.25 (157.25)	884 (42)	845	919
2	782 (116.58)	924.83 (71.44)	796	1024	1195 (193.27)	782 (161.03)	835 (49)	768	996
4	604.75 (101.82)	675.33 (46.57)	463	631	650 (224.54)	592.50 (16.66)	535.33 (39.8)	613.5	631
8	925.75 (114.57)	1010 (123.48)	904.5	905	1101 (72.74)	1127.50 (190.53)	1115 (67.5)	1087	1143
16	578.50 (115.8)	577.16 (123.31)	382	617	628.66 (33.08)	829.75 (94.1)	670.66 (94)	792	617
24	731.25 (264.79)	769 (128.56)	522.5	743	778.33 (56.12)	959.25 (233.98)	940 (119.41)	1003	1024
40	845.25 (483.78)	901.33 (427.74)	648.5	435	797.33 (265.65)	1038 (149.15)	956.33 (263.77)	1087	828
64	1378.50 (228.33)	1302.5 (230.52)	1080	1340	1171 (63.5)	1468 (342.95)	1461.33 (84.67)	1455	1129
168	1432.75 (522.81)	1365.66 (231.4)	1520	870	1103.33 (76.78)	1316.5 (796.35)	1601.66 (101.85)	1466	1403

(Standard deviation in brackets)

- Vib* - *Vibrio sp*
Ent - *Enterobacteriaceae sp*
Pse - *Pseudomonas sp*
Art - *Arthrobacter sp*
Sta - *Staphylococci sp*
Aci - *Acinetobacter sp*
Ach - *Achromobacter sp*

Table 6

Cellular free phosphate accumulation by Gram Positive and Gram Negative bacteria isolated from marine environments of Kerala and Tamilnadu

Incubation Period (Hrs)	Cellular free Phosphate (μM)			
	Water	Sediment	Gram -ve	Gram +ve
1	910.85 (131.65)	879.66 (118.6)	886.04 (108.39)	953.75 (203.4)
2	892.85 (141.54)	878.58 (200)	837.9 (113.54)	1152.25 (179.48)
4	636.07 (117.46)	575.58 (62.21)	601.4 (81.05)	645.25 (183.58)
8	966.85 (125.82)	1118 (109.28)	1033.81 (145.45)	1052 (114.59)
16	55.35 (128.86)	733.5 (111.55)	639.72 (162.54)	625.75 (27.63)
24	718.78 (203.94)	940.5 (151.72)	830.5 (228)	769.5 (49.11)
40	787.57 (415.41)	992.5 (163.1)	914.05 (339.63)	706.75 (282.61)
64	1281.21 (212.85)	1391.83 (226.13)	1353.86 (232.43)	1213.5 (98.99)
168	1354.57 (339.49)	1382.25 (456.5)	1425.95 (393.5)	1045 (132.44)

(Standard deviation in brackets)

Table 7

Low molecular weight Phosphate accumulation by different genera of bacteria isolated from marine environments of Kerala and Tamilnadu

Incubation period (Hrs)	Low molecular weight phosphate ($\mu\text{g}/\text{mg}$ protein)								
	Water					Sediment			
	<i>Vib</i>	<i>Ent</i>	<i>Pse</i>	<i>Art</i>	<i>Staph</i>	<i>Vib</i>	<i>Ent</i>	<i>Aci</i>	<i>Ach</i>
1	0 (0)	0 (0)	0 (0)	0	0 (0)	0 (0)	0 (0)	0	0
2	0 (0)	0 (0)	0 (0)	0	11.93 (20.66)	8.95 (17.9)	114.7 (101.4)	0	0
4	174.95 (92.73)	182.8 (87.73)	159.0 5 (0)	124.7	176 (128.16)	140.15 (90.48)	151.23 (18.6)	44.35	0
8	32.61 (17.94)	45.55 (56.56)	68.9 (0)	42.7	29.16 (17.65)	8.87 (10.75)	40.86 (7.68)	31.55	30.6
16	46.98 (7.87)	46.38 (27.93)	82.8 (0)	59.8	58.56 (20.26)	39.85 (3.7)	66.56 (31.69)	61	54.5
24	32.69 (14)	27.72 (19.66)	61.5 (0)	40.4	44.23 (32.18)	41.12 (30.41)	20.9 (19.83)	8.5	1.8
40	61.44 (36.31)	58.05 (59.41)	60.4 (0)	98.6	64.66 (82.22)	16.95 (14.04)	22.4 (19.45)	25.1	64.2
64	13.11 (5.03)	23.79 (15.38)	41.37 (0)	0	14.3 (12.38)	51.47 (63.54)	27.43 (8.07)	33.3	53.4
168	50.79 (34.18)	44.55 (55.06)	22.95 (0)	61.7	48.8 (70.93)	4.07 (8.15)	13.96 (3.12)	7.75	10.1

(Standard deviation in brackets)

- Vib* - *Vibrio* sp
Ent - *Enterobacteriaceae* sp
Pse - *Pseudomonas* sp
Art - *Arthrobacter* sp
Sta - *Staphylococci* sp
Aci - *Acinetobacter* sp
Ach - *Achromobacter* sp

Table 8

Low molecular weight Phosphate accumulation by Gram Positive and Gram Negative bacteria isolated from marine environments of Kerala and Tamilnadu

Incubation Period (Hrs)	Low molecular weight Phosphate ($\mu\text{g}/\text{mg}$ cell protein)			
	Water	Sediment	Gram -ve	Gram +ve
1	0 (0)	0 (0)	0 (0)	0 (0)
2	9.93 (37.17)	34.65 (66.21)	23.6 (57.09)	8.95 (17.9)
4	180.77 (100)	163.97 (185.1)	174.81 (150.36)	163.17 (107.7)
8	43.54 (38.97)	26.15 (21.38)	36.06 (35.13)	32.55 (15.92)
16	53.7 (23.24)	54.25 (22.37)	53.06 (23.5)	58.87 (16.55)
24	36.54 (25.08)	27.3 (27.5)	30.28 (26.18)	43.27 (26.35)
40	69.33 (49.42)	23.85 (19.47)	43.83 (39.03)	73.15 (69.24)
64	21.39 (17.14)	35.79 (37.24)	31.18 (29.71)	10.72 (12.38)
168	50.59 (46.34)	8.34 (7.08)	27.28 (36.35)	52.05 (58.27)

(Standard deviation in brackets)

Among the isolates studied, species of *Enterobacteriaceae* (182.8 $\mu\text{g Pi/mg protein}$ (SD 87.73)) followed by *Vibrio* sp (174.95, $\mu\text{g Pi/mg protein}$ (SD 92.73)) isolated from sea water recorded the maximum level of Low molecular weight phosphates at 4 hrs(Table 8). Isolates obtained from the marine sediment recorded lower level of these phosphates compared to that of sea water. Among the various species tested species of *Achromobacter* recorded very low level of these phosphates during growth.

Isolates of sea water and sediments, as well as Gram -ve and Gram +ve, all showed wide variation and fluctuation, in terms of increase and decrease in the levels of low molecular weight Phosphates during growth (Table 8). Nevertheless, there was a uniform pattern during lagarithmic and logarithmic phases of growth.

Although no low molecular weight Phosphate could be recorded at 1hr, the Phosphate conc. increased till 4 hrs to a maximum (180.77 and 63.97 $\mu\text{g Pi/mg cell protein}$ respectively for sea water and sediment isolates). Whereas, this high conc. of low M.W. phosphates declined rapidly during 4-8 hrs, such that very low level of them was recorded (43.54 and 26.15 $\mu\text{g Pi/mg cell protein}$ respectively) for both sea water and sediment isolates during this period. This indicated that low molecular weight phosphates decreased during active exponential growth phase. An alternating increase and decrease in this phosphate level in the cells was recorded during the subsequent period of growth. Further an identical trend was also observed with Gram -ve and Gram +ve isolates.

3.1.3.5 Polyphosphate

From the data presented in Table 9, it is evident that none of the isolates accumulated any detectable level of polyphosphate during the first hour of growth. Polyphosphate accumulation was recorded from 2nd hour onwards which reached a maximum at 4 hrs. for all the isolates, except for the species of *Arthrobacter*, *Achromobacter* and *Pseudomonas* for which maximal polyP was recorded, respectively, at 2hrs., 24 hrs. and 40 hrs. An interesting observation made during the study is that, all the isolates spent their polyphosphate during active logarithmic phase, since polyphosphate levels got decreased rapidly during 4-8 hrs., and marginally during 8-16 hrs., of growth. However, at 24 hrs all the isolates showed considerable increase in polyphosphate levels, which declined later at 40 hrs., except in *Pseudomonas* sp which recorded an increase during 16-40 hrs and a maximum polyP. at 40 hrs. PolyP levels in the cells during the stationery phase, after 24 hrs – 7 days were very low when compared to the exponential phase.

Table 9

Polyphosphate accumulation by different genera of bacteria isolated from marine environments of Kerala and Tamilnadu

Incubation period (Hrs)	Polyphosphate ($\mu\text{g}/\text{mg}$ cell protein)								
	Water					Sediment			
	<i>Vib</i>	<i>Ente</i>	<i>Pseu</i>	<i>Arth</i>	<i>Stap</i>	<i>Vib</i>	<i>Ente</i>	<i>Acin</i>	<i>Achr</i>
1	0 (0)	0 (0)	0 (0)	0 (0)	0 (0)	0 (0)	0 (0)	0 (0)	0 (0)
2	12.42 (24.85)	6.52 (15.97)	2.05 (0)	50.65 (0)	0 (0)	28.58 (20.75)	21.36 (19.28)	0 (0)	0 (0)
4	37.27 (10.89)	20.98 (15.35)	10.87 (0)	40.24 (0)	20.84 (9.54)	34.14 (17.30)	26.05 (19.96)	45.26 (0)	8.01 (0)
8	7.59 (0.7)	7.29 (2.95)	6.5 (0)	10.05 (0)	6.23 (2.23)	8.5 (3.27)	8.58 (2.12)	8.33 (0)	3.17 (0)
16	6.09 (0.97)	6.69 (3.23)	6.16 (0)	8.16 (0)	4.97 (1.2)	7.14 (1.77)	10.71 (3.84)	6.55 (0)	4.4 (0)
24	12.4 (4.05)	15.9 (2.22)	11.64 (0)	13.66 (0)	16.87 (2.27)	14.37 (0.95)	13.96 (2.95)	15.97 (0)	16.2 (0)
40	8.63 (2.04)	11.64 (3.45)	12.22 (0)	8.04 (0)	10.34 (1.54)	9.76 (0.80)	10.26 (2.74)	10.39 (0)	7.78 (0)
64	4.03 (3.06)	6.82 (5.73)	5.12 (0)	4.5 (0)	5.24 (1.13)	5.01 (1)	4.36 (0.78)	7.18 (0)	4.38 (0)
168	5.6 (4.09)	5.38 (2.98)	9.09 (0)	6.41 (0)	5.36 (2.05)	9.48 (6.61)	7.3 (3.6)	8.06 (0)	6.51 (0)

(Standard deviation in brackets)

- Vib* - *Vibrio sp*
Ent - *Enterobacteriaceae sp*
Pse - *Pseudomonas sp*
Art - *Arthrobacter sp*
Sta - *Staphylococci sp*
Aci - *Acinetobacter sp*
Ach - *Achromobacter sp*

Table 10

Polyphosphate accumulation by Gram Positive and Gram Negative bacteria isolated from marine environments of Kerala and Tamilnadu

Incubation Period (Hrs)	Polyphosphate ($\mu\text{g}/\text{mg}$ cell protein)			
	Water	Sediment	Gram -ve	Gram +ve
1	0 (0)	0 (0)	0 (0)	0 (0)
2	10.25 (19.82)	14.86 (19.11)	12.33 (18.7)	12.66 (25.32)
4	25.94 (14.81)	29.14 (23.29)	27.73 (20)	25.69 (12.43)
8	7.27 (2.39)	7.79 (2.64)	7.57 (2.5)	7.18 (2.64)
16	6.33 (2.83)	7.45 (2.84)	7.04 (2.97)	5.77 (1.86)
24	14.35 (3.72)	14.92 (1.72)	14.35 (2.98)	16.07 (2.45)
40	10.39 (3.41)	10.06 (1.9)	10.23 (2.94)	9.76 (1.7)
64	5.59 (4.05)	5.09 (1.24)	5.42 (3.3)	5.06 (0.99)
168	5.89 (3.14)	7.94 (4.01)	7.06 (3.88)	5.62 (1.75)

(Standard deviation in brackets)

Among the various isolates tested *Arthrobacter* sp recorded maximal polyP (50.65 μg /mg cell protein) followed by *Acinetobacter* (45.26 μg /mg cell protein), *Vibrio* sp (37.27 μg /mg cell protein), and *Enterobacteriaceae* (26.05 μg /mg cell protein), *Pseudomonas* sp (12.2 μg /mg cell protein at 40 hrs.), and *Achromobacter* sp recorded the lowest levels of polyP(16.2 μg /mg cell protein at 24 hr).

Gradual increase in polyP was registered after 1hr such that a maximum of 25.94 and 29.14 μg /mg cell protein respectively for the isolates of sea water and sediment, and 27.73 and 35.69 μg /mg cell protein respectively for the Gram –ve and Gram +ve isolates, were recorded after 4 hrs(Table 10). However, polyP levels rapidly declined to a minimum, during the subsequent period of 4-16 hrs., (logarithmic phase of growth) such that 6.33 and 7.45 μg /mg cell protein, respectively, for the isolates of sea water and sediment, and 7.04 and 5.77 μg /mg cell protein respectively for the Gram –ve and Gram +ve isolates were recorded. Although polyP recorded considerable increase at 24 hrs, irrespective of the source of isolates or whether they are Gram –ve or Gram +ve, it declined rapidly again during 24-64 hrs., suggesting that polyP accumulation does not take place during stationery phase.

3.1.3.6 Nucleic acid phosphates

Maximal levels of nucleic acid phosphates were recorded during early phase of growth (Logarithmic phase – 2-4 hrs) for the isolates (Table 11). While species of *Vibrio*, *Arthrobacter* and *Staphylococci* obtained from sea water recorded their maximal nucleic acid phosphates at 2 hrs., species of *Vibrio* *Enterobacteriaceae*, *Pseudomonas*, *Acinetobacter* and *Achromobacter* isolated from marine sediment, recorded their maxima at 4 hrs. Further, all the isolates recorded considerable decrease in their nucleic acid phosphate levels at 8 hrs. Later period of growth witnessed rise and fall, in the levels of Pi indicating wide fluctuation. Variation in the level of nucleic acid phosphate levels was not very much marked during the stationery phase of growth compared to early phase of growth. Maximal nucleic acid phosphate conc. in the cells was recorded in *Staphylococci* sp.(10.2 μg /mg cell protein) followed by *Vibrio* sp.(9.49 μg /mg cell protein)*Enterobacteriaceae* (8.92 μg /mg cell protein) isolated from sediment.

Although nucleic acid phosphates were not detected at 1 hr., they could be recorded at their maximum level of 8.49 and 9.53 μg /mg cell protein respectively for the isolates of the sediment and Gram +ve.(Table 12). Whereas, isolates of sea water and Gram –ve, recorded their

Table 11

Nucleic acid phosphate accumulation by different genera of bacteria isolated from marine environments of Kerala and Tamilnadu

Incubation period (Hrs)	Nucleic acid phosphate ($\mu\text{g}/\text{mg}$ cell protein)								
	Water					Sediment			
	<i>Vib</i>	<i>Ent</i>	<i>Pse</i>	<i>Art</i>	<i>Staph</i>	<i>Vib</i>	<i>Ent</i>	<i>Aci</i>	<i>Ach</i>
1	0 (0)	0 (0)	0 (0)	0 (0)	0 (0)	0 (0)	0 (0)	0 (0)	0 (0)
2	7.13 (5.91)	4.24 (5.42)	3.08 (0)	7.5 (0)	10.2 (9.2)	9.36 (2.89)	5.8 (5.86)	8.21 (0)	0 (0)
4	5.48 (1.52)	5.42 (1.36)	6.02 (0)	6.03 (0)	6.66 (1.76)	9.49 (3.30)	8.92 (3.78)	8.4 (0)	4 (0)
8	3.44 (0.26)	3.36 (0.35)	2.64 (0)	4.19 (0)	3.17 (0.4)	3.54 (0.86)	3.71 (1.44)	2.76 (0)	1.58 (0)
16	3.28 (0.35)	3.05 (0.6)	2.88 (0)	5.1 (0)	3.41 (0.11)	3.63 (0.49)	3.5 (0.85)	3.22 (0)	1.32 (0)
24	3.05 (0.95)	3.05 (0.88)	3.41 (0)	4.37 (0)	3.2 (1.04)	3.11 (0.82)	4.48 (0.97)	2.4 (0)	3.62 (0)
40	3.53 (0.68)	3.82 (1.71)	5.17 (0)	3.75 (0)	4.03 (0.31)	3.83 (0.55)	3.9 (1.16)	2.37 (0)	1.45 (0)
64	3.45 (1.48)	3.39 (1.29)	2.19 (0)	4.22 (0)	3.64 (0.29)	3.35 (0.2)	3.99 (0.37)	2.1 (0)	1.31 (0)
168	1.87 (0.94)	1.36 (0.66)	1.48 (0)	2.9 (0)	0.85 (0.44)	1.29 (0.2)	1.11 (0.3)	0.45 (0)	1.08 (0)

(Standard deviation in brackets)

Vib - *Vibrio* sp
Ent - *Enterobacteriaceae* sp
Pse - *Pseudomonas* sp
Art - *Arthrobacter* sp
Sta - *Staphylococci* sp
Aci - *Acinetobacter* sp
Ach - *Achromobacter* sp

Table 12

Nucleic acid phosphate accumulation by Gram Positive and Gram Negative bacteria isolated from marine environments of Kerala and Tamilnadu

Incubation Period (Hrs)	Nucleic acid phosphate ($\mu\text{g}/\text{mg}$ cell protein)			
	Water	Sediment	Gram -ve	Gram +ve
1	0 (0)	0 (0)	0 (0)	0 (0)
2	4.83 (5.04)	8.49 (6.28)	5.97 (5.48)	9.53 (7.68)
4	5.64 (1.36)	8.25 (3.16)	6.91 (2.85)	6.5 (1.47)
8	3.3 (0.48)	3.25 (1)	3.25 (0.78)	3.42 (0.6)
16	3.25 (0.75)	3.31 (0.83)	3.18 (0.73)	3.83 (0.84)
24	3.15 (0.86)	3.46 (1)	3.25 (0.92)	3.49 (1.03)
40	3.93 (1.28)	3.45 (1.09)	3.66 (1.3)	3.96 (0.29)
64	3.34 (1.32)	3.15 (0.99)	3.15 (1.24)	3.78 (0.37)
168	1.61 (0.77)	1 (0.4)	1.32 (0.62)	1.36 (1.08)

(Standard deviation in brackets)

maximal nucleic acid phosphates of 5.64 and 6.91 $\mu\text{g Pi/mg cell protein}$, respectively. Nevertheless, the nucleic acid phosphates declined rapidly during 4-8 hrs. and remained almost stable with marginal fluctuation during 8-64 hrs in all the cases.

3.2. Selection of Potential Strains capable of accumulating polyphosphate

Based on the efficiency to effect maximal Pi uptake and release and polyP accumulation, the *Vibrio* sp. BTDW128 and *Achromobacter* BTDS 64 were selected to study the impact of the environmental factors on Pi uptake and release, and polyP accumulation.

1. *Vibrio* sp BTDW 128

This particular strain, isolated from seawater, accumulated high levels of polyphosphate and demonstrated unlimited Pi uptake and release properties. Further, it showed very high Pi scavenging ability such that the Pi concentration in the medium was reduced to absolute zero, and also released Pi from the cells at considerable level during anaerobic (static) conditions. Besides these characteristics, the strain was observed to grow rapidly.

2. *Achromobacter* BTDS 64

This strain, isolated from marine sediment, showed exactly contrasting characteristics when compared to the *Vibrio* sp. strain. Under normal conditions in ZMB this strain showed slow growth such that obvious colony could be observed only after 36-48 hrs, unlike the *Vibrio* sp for which colonies appeared after 12 hrs. Further, this strain could accumulate relatively low polyP and showed limited capacity for Pi uptake. Nevertheless, irrespective of the conditions this bacteria exhibited 50-80% Pi removal from the medium depending on the initial Pi concentration in the medium. Interestingly, complete removal of Pi was never observed even at the lowest concentration of Pi studied, unlike that observed with *Vibrio* sp, which could uptake Pi completely even at the highest level of Pi studied (12,000 μM). Due to these characteristics this strain was also studied along with *Vibrio* sp in order to have a comparison with *Vibrio* sp.

3.3. Effect of Phosphate conc. in the medium on phosphate uptake and polyphosphate Accumulation by marine bacteria.

Impact of varying concentration of phosphate, in addition to the phosphate already available in the Zobell's marine broth, on the rate of phosphate uptake and polyP accumulation by marine bacteria was studied using KH_2PO_4 as source of phosphate. Results obtained for the

various studies conducted with *Vibrio* sp and *Achromobacter* sp are presented in Figures 4-9.

***Vibrio* sp**

Data presented in **Fig.4** clearly evidence the direct impact of different conc. of inorganic phosphate on the phosphate (Pi) uptake by marine *Vibrio* sp. Very interestingly, at all the conc. of Pi tested, the growing cells, in the logarithmic phase of growth, recorded rapid uptake of Pi during the first hour of growth itself. The rate of removal was proportionately high along with the increase in initial conc. of Pi in the medium. However, for conc. of Pi above 500 μ M, there was no uptake into cells, and instead there was release of Pi from the cells into the medium, during 4-8 hrs. (log phase). Whereas, at 9000 μ M, during 8-12 hrs, there was rapid uptake of Pi from the medium compared to that observed for other initial Pi conc. tested. Nevertheless, at all initial Pi conc. tested there was complete removal of Pi from medium during later hours of growth, after 20 hrs. The maximal Pi uptake occurred at highest Pi conc. (12000 μ M), (162.3 μ M Pi/mg dry wt). at 48 hrs.

From the results depicted in **Fig.5** it is evident that there was rapid accumulation of polyP, which increased during 1-4 hrs; 8-20 hrs and 28-36 hrs. Interestingly polyP levels declined during 4-8 hrs (log phase) & 36-48 hrs, and the rate of decrease was proportionately high for higher conc. of Pi tested. In general, rate of polyP accumulation was concordant with increase in the conc. of Pi in the medium and Pi uptake. There was a contrasting observation with control during 20-28 hrs, when polyP accumulation was very rapid compared to others. In fact, at the same time polyP level declined for the Pi conc. of 9000 μ M and 12000 μ M.

Similarly control medium showed rapid decline in polyP levels of cells during 28-36 hrs, while at Pi conc. above 500 μ M there was increase in polyP in the cells. The maximal polyP (25.12 μ g/mg dry wt) also occurred at 12,000 μ M, forming almost 2.5% of the bacterial dry cell weight.

Data interpreted with reference to interrelationship between biomass, Pi uptake and polyP accumulation by marine *Vibrio* sp is presented in **Fig. 6**. Rapid Pi uptake by cells during the first hour of growth was concordant with increase in biomass, invariably at all the Pi conc. tested. Whereas, after 1 hour, there was differential response by the cells for the various Pi conc. tested. Thus the rate of Pi uptake declined rapidly during 1-8 hrs. of growth, irrespective of increase in biomass, except for the initial Pi conc. of 9000 μ M and 12000 μ M. where there was increase in Pi uptake during 1-4 hrs and decrease in Pi uptake during 4-8 hrs. Apparently, there was no relationship between Pi uptake and polyP accumulation, except at 9000 μ M and 12000 μ M of initial

Fig.4 Effect of inorganic phosphate (Pi) on phosphate uptake by *Vibrio* sp BTDW-128, during growth in Zobell's marine broth(ZMB)

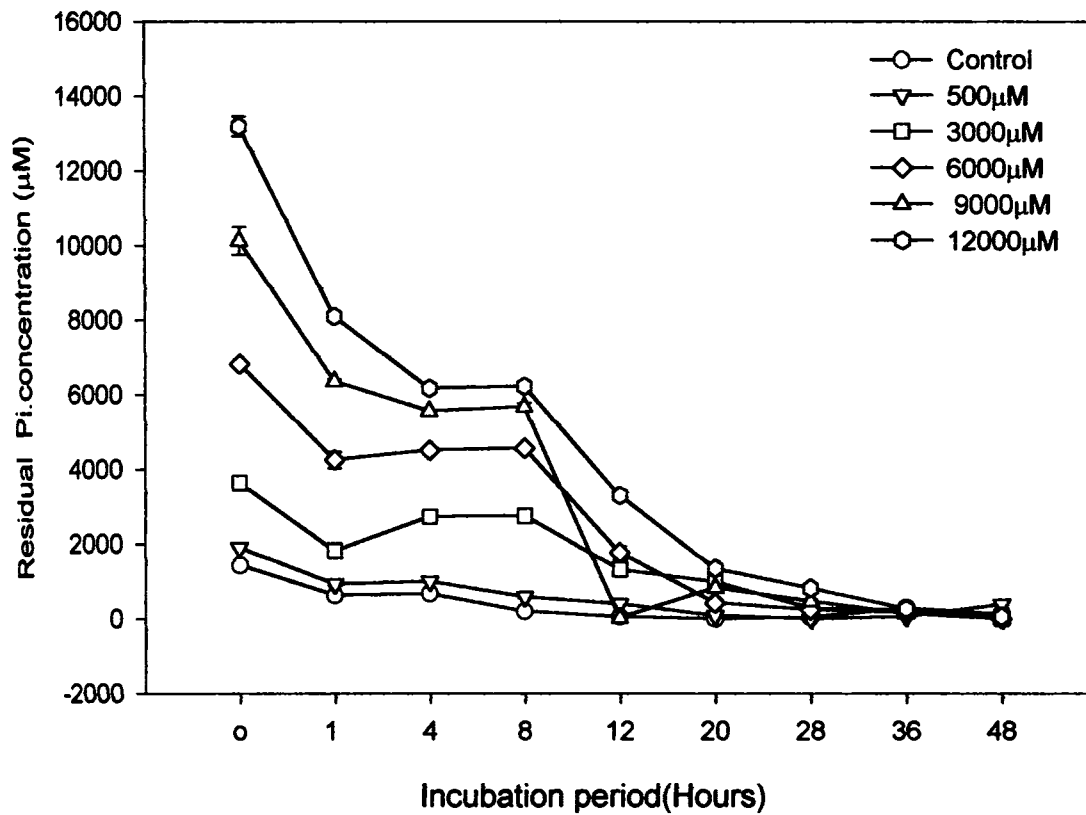
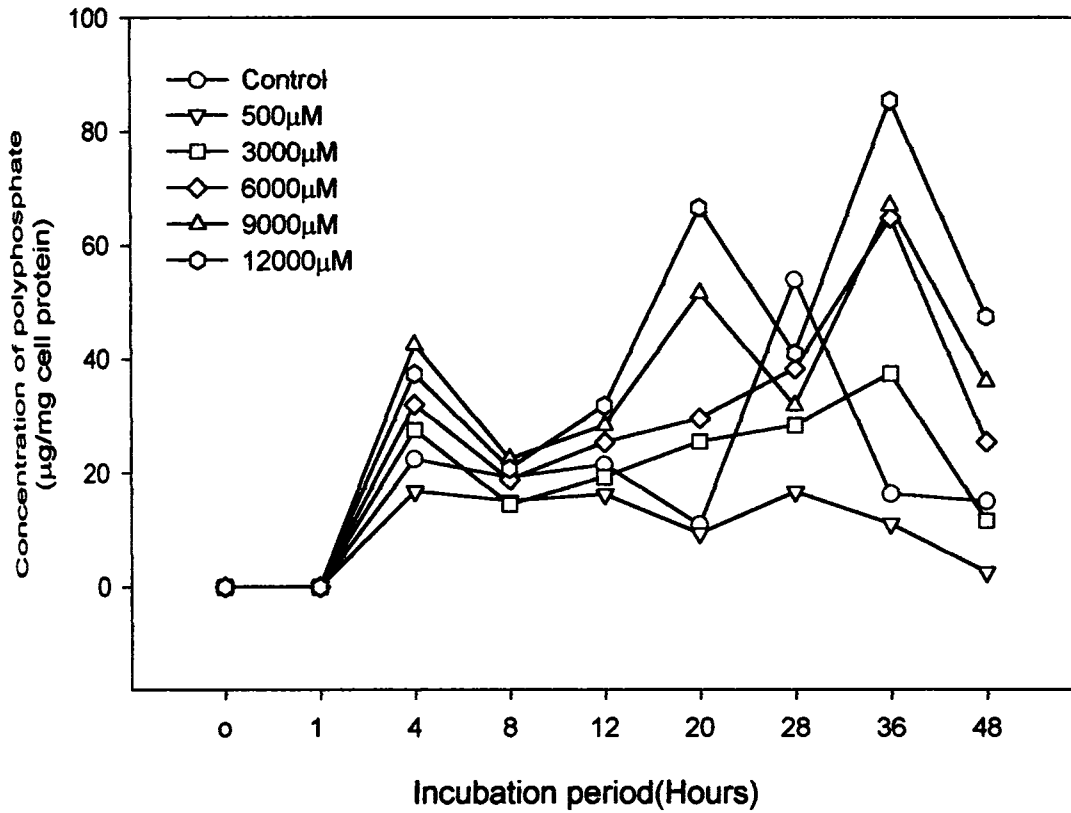
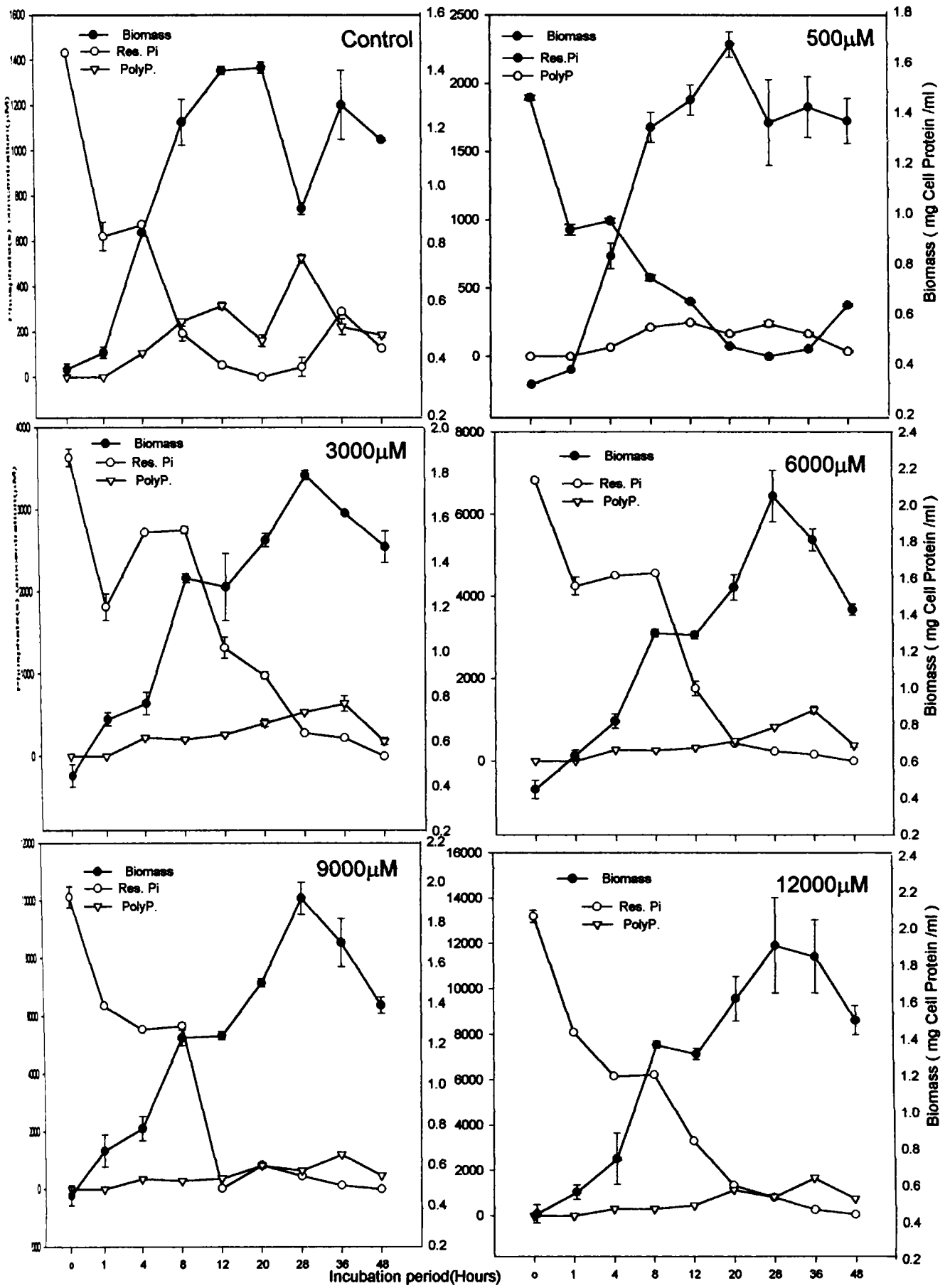

Fig.5 Effect of inorganic phosphate (pi) on polyphosphate(polyP) accumulation by *Vibrio* sp.BTDW-128 during growth in Zobell's marine broth (ZMB)



36 Effect of inorganic phosphate(Pi) on biomass, Pi uptake and polyphosphate (polyP) accumulation by *Vibrio* sp. BTDW-128 during growth in Zobell's marine broth(ZMB)



Pi conc., during 1-4 hrs. Otherwise Pi uptake and polyP showed a negative relationship during 1-4 hrs. Interestingly, in the control medium, (ZMB) without additional Pi conc., polyP increased and decreased concomitantly with increase and decrease in Pi uptake, respectively, during 20-28 hrs and 28-36 hrs, while biomass showed a negative relationship during these periods. At other occasions, there was no clear relationship between biomass and polyP accumulation.

Achromobacter sp

It is inferred from the results depicted in **Fig.7** that *Achromobacter sp* responded to varying initial conc. of Pi in the cultivation medium, in terms of its Pi uptake efficiency. This strain could rapidly uptake Pi during the first hour of growth, during the lag phase, and the rate of Pi uptake increased along with increase in initial conc. of Pi in the medium. However, after one hour there was no rapid Pi uptake. In fact, for the initial Pi conc. of 3000 μ M and above, the cells showed some response. At all the higher levels of initial Pi conc., there was marginal Pi uptake during 8-12 hrs and 38-48 hrs, and a gradual release of Pi from the cells during 12-36 hrs. Whereas, both in the control medium and at 500 μ M Pi conc. there was neither significant uptake of Pi nor its release during this period.

Results presented in **Fig.8** indicate that rapid accumulation of polyP took place during 1-4 hrs at all the conc. of initial Pi and in the control medium, except at 500 μ M Pi where the rate of polyP accumulation was relatively less. Interestingly, irrespective of the initial Pi conc. tested the polyP level declined during 4-8 hrs (log phase). Whereas, there was differential response during the later period of growth. Thus, in the control medium and at 500 μ M . Pi conc., polyP levels increased during 8-12 hrs followed by rapid decline during 12-20 hrs. Whereas, in contrast, at higher conc. of initial Pi (3000 μ M - 12000 μ M) polyP levels declined initially during 8-12 hrs, and increased, later, rapidly during 12-20 hrs. In general, there was significant change in the pattern of increase and decrease in polyP after 12 hrs. During the stationery phase, there was polyP accumulation at higher initial Pi conc. while exponential phase experienced decline in polyP levels.

Interrelationships between biomass, Pi uptake and polyP accumulation by *Achromobacter sp* in response to varying conc. of initial Pi in the medium is presented in **Fig.9**. There was an increase in the rate of Pi uptake along with increase in biomass during the first 4 hours (0 – 4 hrs) of growth except at 3000 μ M Pi conc., where the Pi uptake declined along with increase in biomass during 1-4 hrs. Further, interestingly, during 4-8 hrs of growth (Log. Phase) while the biomass increased Pi uptake declined indicating release of Pi in to the medium, at all the Pi conc. tested. Pi uptake and PolyP accumulation had a positive relation of concomitant increase during 1-4 hrs at all

Fig.7 Effect of inorganic phosphate (Pi) on phosphate uptake by *Achromobacter* sp BTD-64, during growth in Zobell's marine broth(ZMB)

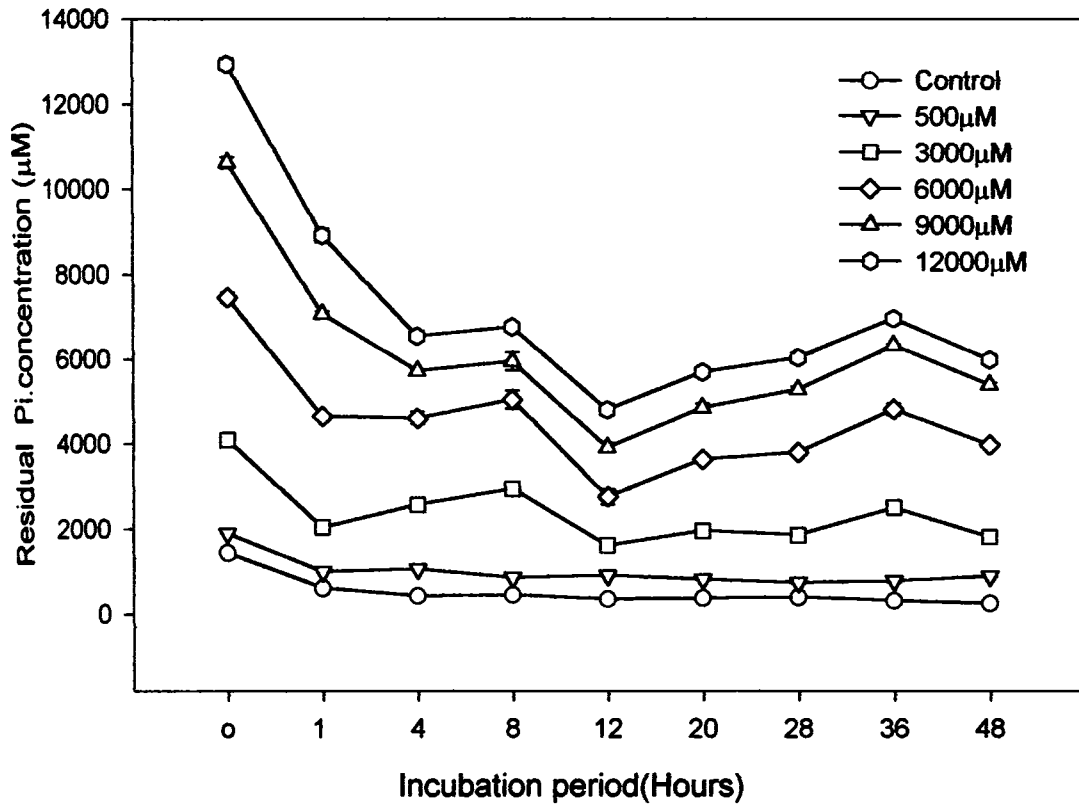
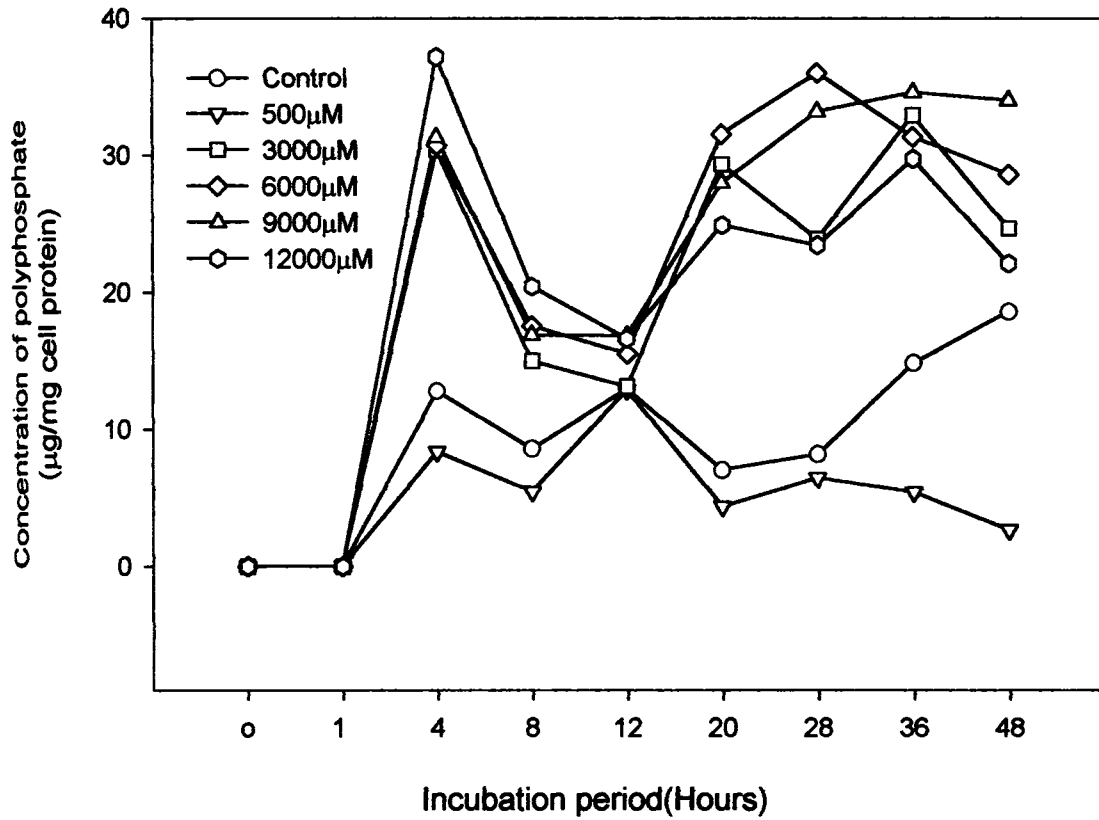

Fig.8 Effect of inorganic phosphate on polyphosphate(polyP) accumulation by *Achromobacter* sp.BTDS-64 during growth in Zobell's marine broth (ZMB)



the Pi conc. tested, except at 9000 μ M and at 3000 μ M when the polyP increased along with decrease in Pi uptake. Biomass and polyP accumulation also had a concordant increase at all the conc. of initial Pi tested except at at 6000 μ M and at 9000 μ M Pi.

3.4 Effect of pH on phosphate uptake and polyphosphate accumulation by Marine bacteria *Vibrio sp*

Results obtained for the studies conducted on the effect of various pH of the Zobell's Marine Broth on *Vibrio sp* are presented in Figs. 10-12. Data presented in **Fig.10** clearly testified that pH of the medium influenced the initial conc. of Pi in the medium and subsequent Pi uptake by *Vibrio sp*. It is evident from the data that the rate of Pi uptake is significantly influenced by the pH of the cultivation medium. Increase in alkalinity from pH 8.0 to pH 12.0, through pH 10.0, not only led to decline in Pi uptake, but also has led to the release of Pi into the medium (at pH 10.0). There was no detectable activity at pH 12.0. Whereas, at pH 8.0 there was rapid release of Pi into the medium, during 12-20 hrs, followed by immediate Pi uptake during 20-28 hrs. At acidic condition of pH 6.0 there was a gradual decline in the level of Pi during 0-12 hrs followed by a rapid decline during 12-20 hrs, indicating Pi uptake. Further, there was release of Pi into the medium during 20-28 hrs followed by Pi uptake during 28-36 hrs.

From the results presented in **Fig.11** it was inferred that both pH 6.0 and pH 12.0 did affect the efficiency of polyP accumulation by the cells when compared to that of pH 8.0 and pH 10.0. It was observed that at pH 8.0 the rate of polyP accumulation per mg of biomass enhanced significantly during 0-4 hrs compared to that observed during 1-4 hrs for pH 7.0 and pH 10.0. However, alkaline pH conditions affected the efficiency of the cells compared to neutral pH. Thus, pH 10.0 led to rapid decline in the efficiency of cells to accumulate polyP during 4-20 hrs. In the case of pH 8.0, the efficiency of cells to accumulate polyP declined rapidly during 8-20 hrs and 28-36 hrs. In general, irrespective of pH, the efficiency of polyP accumulation increased during 20-28 hrs and declined during 28-36 hrs. Interestingly at pH 10.0 and pH 6.0, the efficiency of polyP accumulation by cells rapidly increased during 36-48 hrs.

Compared to that at pH 7.0, biomass increase was rapid during 1-8 hrs, at pH 6.0 and at alkaline pH conditions (**Fig.12**). At pH 12.0, biomass increased rapidly to a maximum by 8 hrs, denoting the stationary phase, compared to all other pH conditions. Except at pH 10.0 and at pH 12.0, at other pH conditions increase in biomass coincided with Pi uptake. Whereas, at pH 10.0 there was release of Pi into the medium along with increase in biomass up to 20 hrs. However, at pH 12.0 there was no activity. While at pH 6.0, and at the three alkaline pH conditions polyP

Fig.10 Effect of pH on phosphate(Pi) uptake by *Vibrio* sp BTDW-128, during growth in Zobell's marine broth(ZMB)

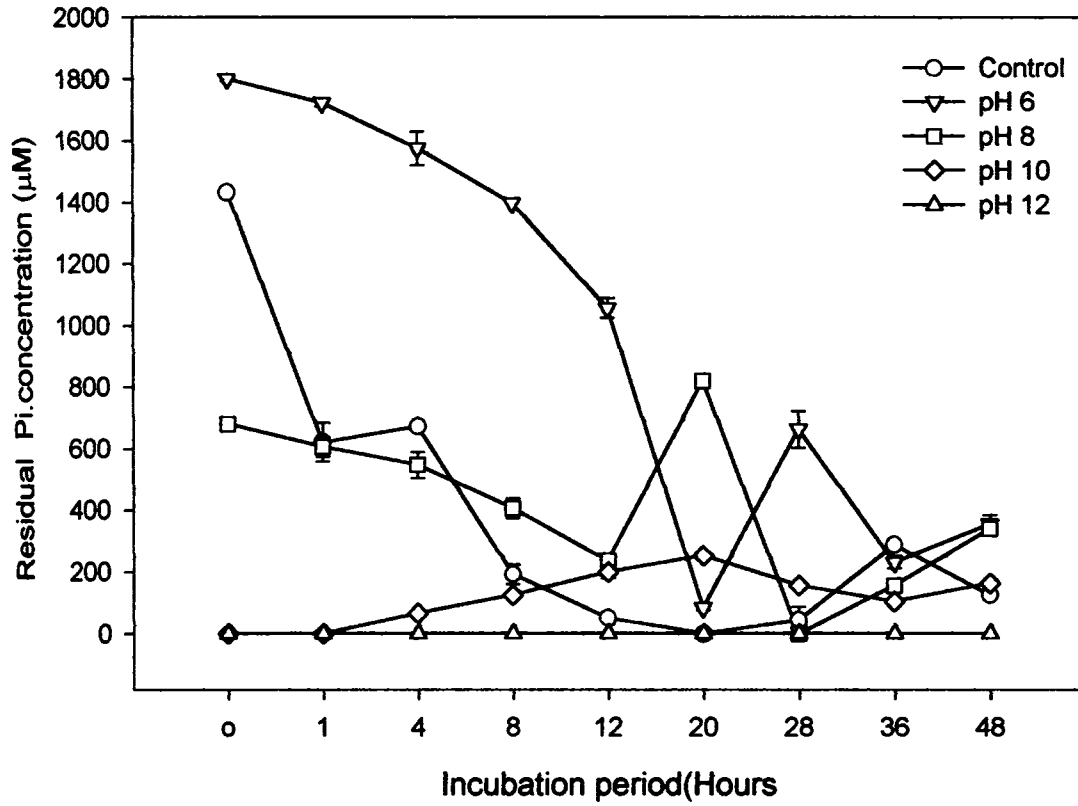

Fig.11 Effect of pH on polyphosphate(polyP) accumulation by *Vibrio* sp BTDW-128 during growth in Zobell's marine broth (ZMB)

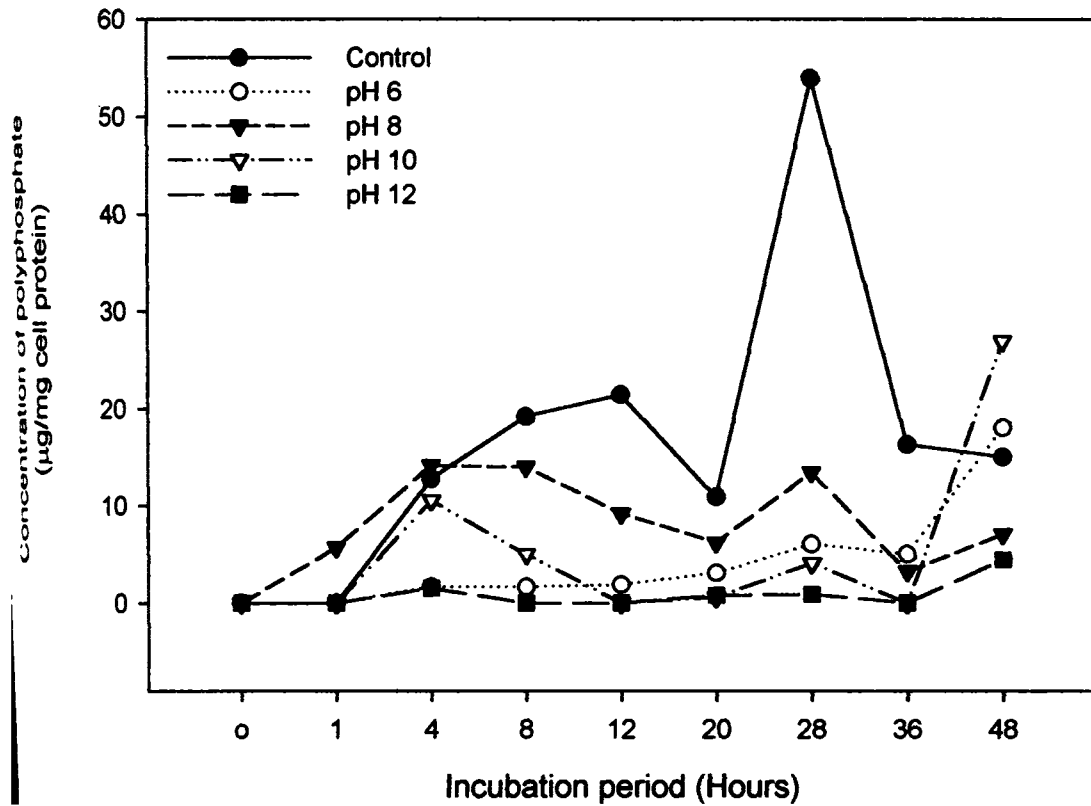
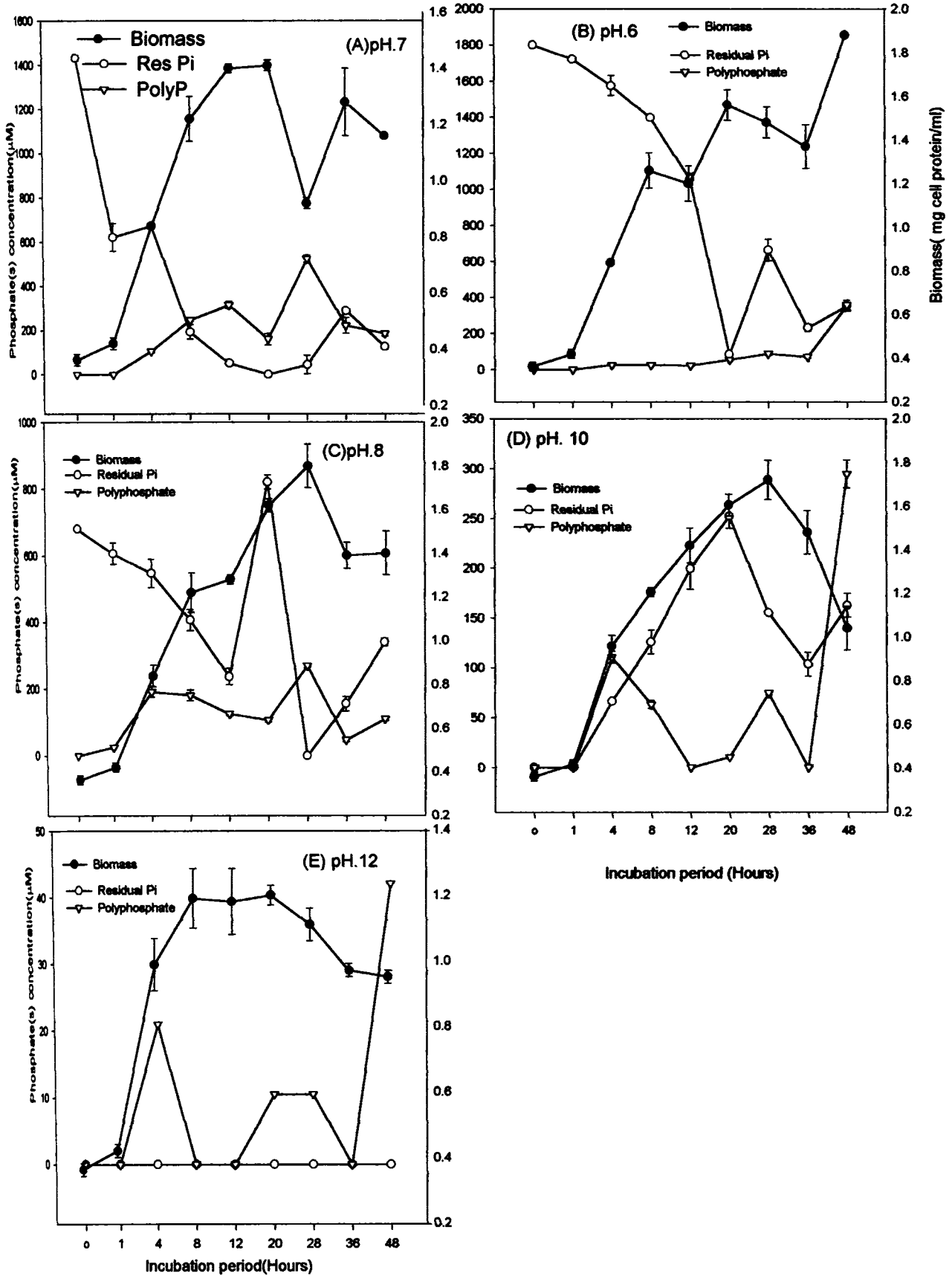

Fig.12 Effect of pH on biomass, Pi uptake and polyphosphate (polyP) accumulation by *Vibrio* sp BTDW-128 during growth in Zobell's marine broth(ZMB)



accumulation recorded an increase along with increase in biomass, during 1-4 hrs, followed by a rapid decline. However, it increased again later during 12-20 hrs. Interestingly at both acidic and alkaline pH polyP accumulation increased during 36-48 hrs when compared to other pH conditions, unlike the control.

Achromobacter sp

Response of *Achromobacter sp* to variation in the pH of the medium in terms of phosphate uptake and polyP accumulation is presented in Figs.13-15. Impact of pH on Pi uptake by of *Achromobacter sp* is presented in **Fig. 13**. Interestingly, at pH 10.0 and 12.0 in the medium, there was no free residual phosphate available for uptake by the cells (Fig.13). However, at pH 10.0 there was marginal release of Pi into the medium as suggested by marginal increase in residual Pi during 28-36 hrs. It is evident that pH of the medium influenced availability of free Pi in the medium, Pi uptake and Pi release and increase in pH in the alkaline side resulted in reduction in the availability of Pi. Interestingly at pH 6.0 there was more free Pi available at 0 hr, but there was no significant uptake of Pi till 20 hrs. The residual Pi declined during 20-28 hrs., followed by an increase in Pi indicating release of Pi into the medium, after 28-36 hrs. At pH 7.0, after an initial Pi uptake (0-4 hr), there was no significant change in the subsequent period. Whereas, at pH 8.0 there was a marginal increase after 4 hrs. Nevertheless, pH 6.0 and pH 8.0 showed almost an identical pattern of impact between 20-36 hrs.

Data presented in **Fig.14** denoted that the rate of polyP accumulation was drastically affected by the alkaline pH conditions, pH 10.0 and pH 12.0, as well as pH 6.0., during 0-12 hrs. In fact pH 8.0 supported enhanced rate of polyP accumulation compared to pH 7.0 during most of the time. However, during 8-20 hrs and 36-48 hrs contrasting observations were made. While the rate of polyP accumulation declined marginally at pH 8.0 during 8-12 hrs there was rapid increase at pH 7.0. While the polyP declined at pH 7.0 during 12-20 hrs and 36-48 hrs., it increased at pH 8.0. Particularly the rate of polyP accumulation was very high at pH 8.0 during 36-48 hrs. The maximal polyP was recorded during this time, which was well above the control.

Data presented in **Fig.15** also evidence that there was no activity of Pi uptake or polyP accumulation at pH 10.0 and pH 12.0 although there was release of Pi from the cells into the medium during 28-36 hrs at pH 10.0. Of course there was some relation between Pi uptake and polyP accumulation at pH 8.0.

Fig.13 Effect of pH on phosphate(Pi) uptake by *Achromobacter* sp BTDS-64, during growth in Zobell's marine broth(ZMB)

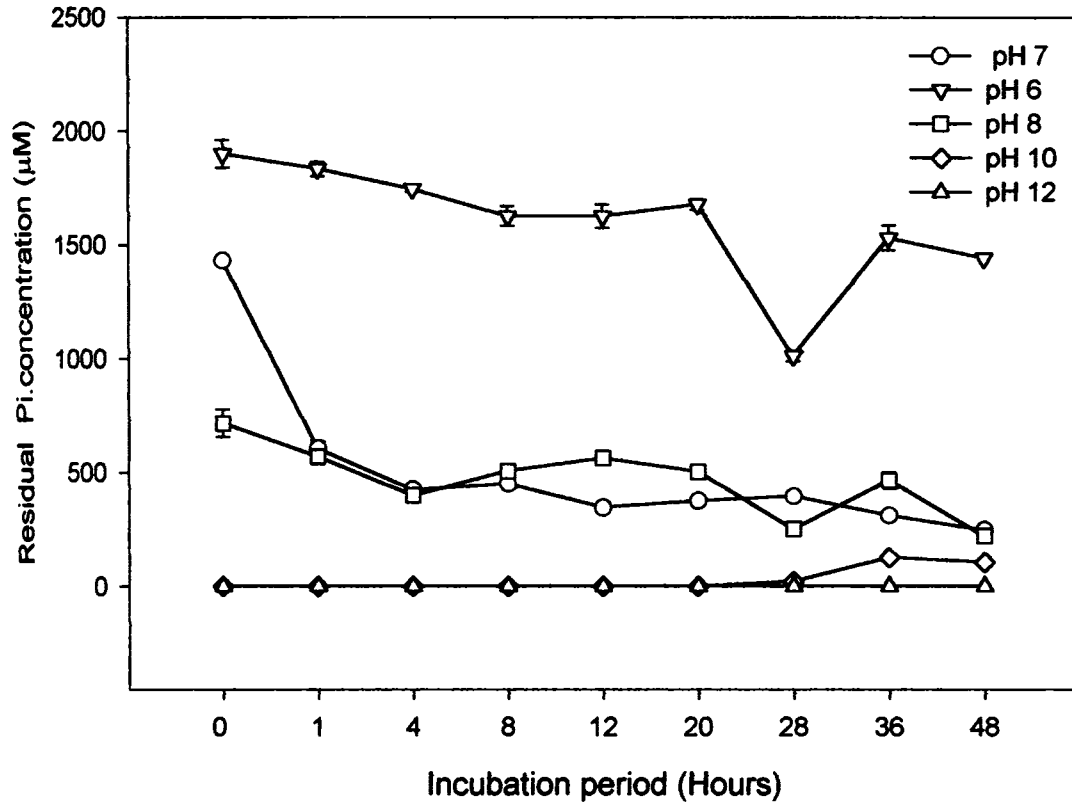

Fig.14 Effect of pH on polyphosphate(polyP) accumulation by *Achromobacter sp* BTDS-64 during growth in Zobell's marine broth (ZMB)

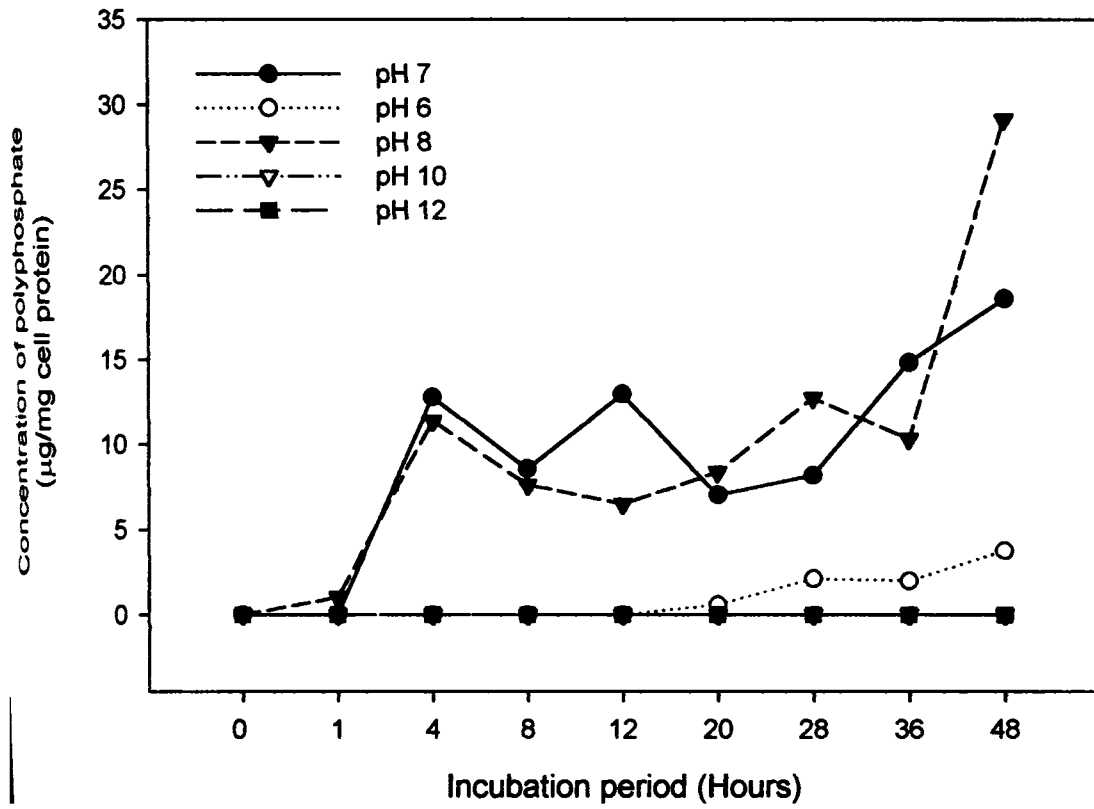
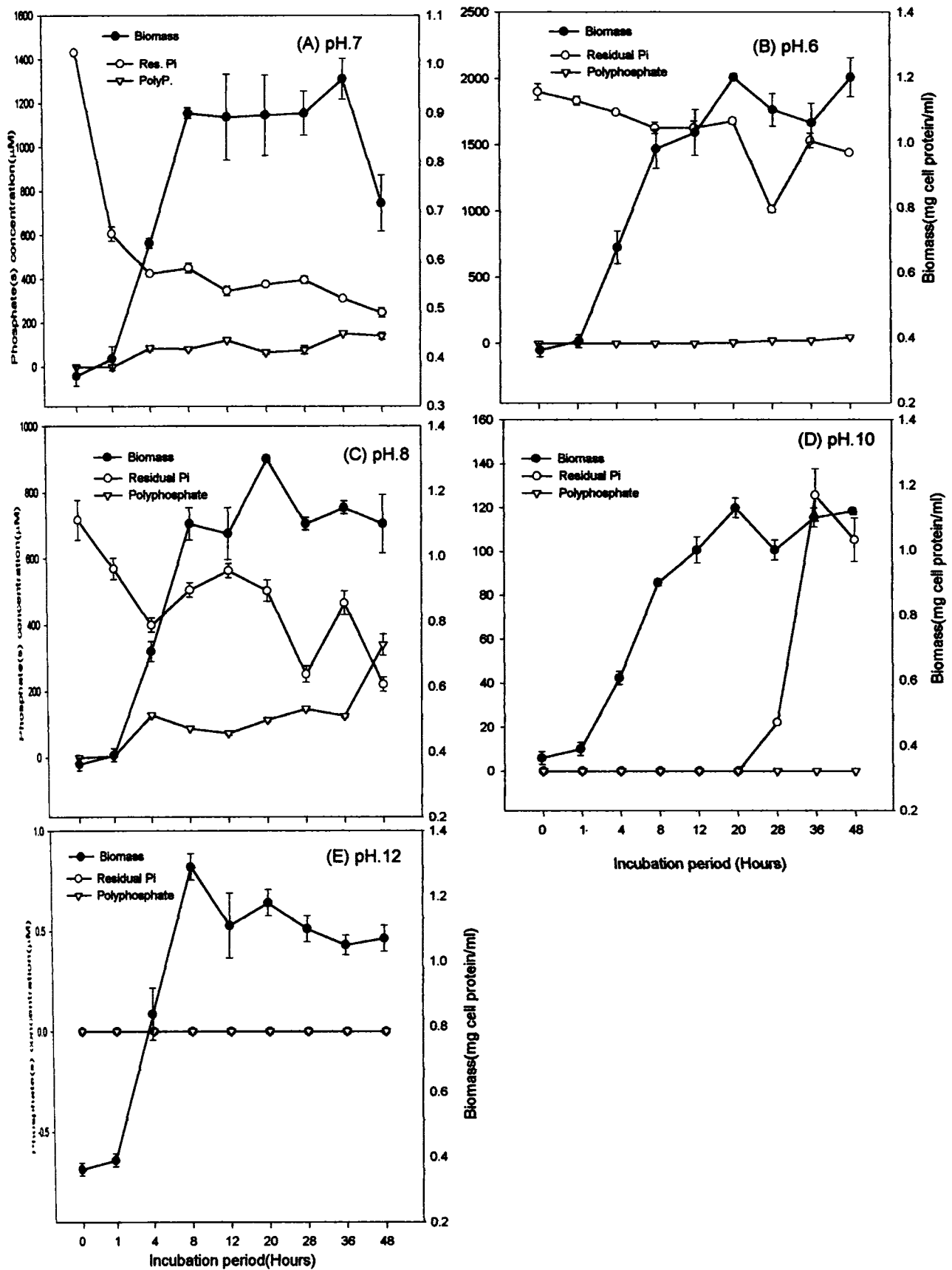

Fig.15 Effect of pH on biomass, Pi uptake and polyphosphate (polyP) accumulation by *Achromobacter* sp BTD-64 during growth in Zobell's marine broth(ZMB)



3.5 Effect of Temperature on Pi uptake and polyP accumulation by marine bacteria

Effect of incubation temperature on phosphate uptake and polyP accumulation by marine bacteria was evaluated at different temperatures and the results are presented in Fig. 16-21.

Vibrio sp

In general variation in incubation temperature did not influence significantly the rate of phosphate uptake by *Vibrio sp.* and almost a similar trend was recorded (**Fig.16**). Invariably, at all the incubation temperatures tested, there was rapid Pi uptake during the first hour and there was only marginal difference among the incubation temperatures evaluated. While there was Pi uptake at 40°C and 55°C, there was release of Pi at 45°C and 50°C during 1-4 hrs. Release of Pi continued till 8 hrs at 55°C, while at other temperatures there was Pi uptake during 4-8 hrs. Nevertheless, there was progressive increase in Pi uptake during 8-20 hrs. Pi release was also observed during 20-28 hrs, at 45°C, during 36-48 hrs at RT and at 50°C. At other instances, and during later period of incubation there was no significant Pi uptake or Pi release.

From data presented in **Fig.17**, it is evident that polyP accumulation followed, a similar trend and recorded identical levels at all the incubation temperatures tested, except for a sudden steep increase during 12-20 hrs at 55°C, followed by a rapid decline during 20-48 hrs. PolyP accumulation was recorded during 1-4 hrs at all temperatures tested except at 45°C, when it was recorded during 20-28 hrs. Results also indicated that efficiency of cells for polyP accumulation was influenced by increase in incubation temperature uniformly. Interestingly, at 55°C, the rate of polyP accumulation recorded a sudden increase to a maximum during 12-20 hrs followed by a sudden and rapid decline during 20-28 hrs.

From the data elucidated in **Fig.18**, it could be inferred that efficiency of cells for Pi uptake increased rapidly and remained stable at higher temperatures of 35°C, 40°C and 50°C compared to 45 and 50°C. There was no clear relationship between the variables analysed. Rapid uptake of Pi during 0-1 hrs. was not associated with biomass increase. Of course varied response of cells was recorded for the different temperatures tested. Thus, increase in biomass was associated with increase in Pi uptake during 1-4 hrs at 40°C and 55°C, while associated with decrease in Pi uptake during 1-4 hrs at RT, 35°C, 45°C and at 55°C. In fact, Pi uptake and biomass accumulation was concordant with respect to Pi conc. at 35°C, 40°C and 50°C, though minor fluctuations were there. Whereas, polyP levels and Pi uptake rate were not always positive. At most instances,

Fig.16 Effect of temperature on phosphate(Pi) uptake by *Vibrio* sp BTDW-128, during growth in Zobell's marine broth(ZMB)

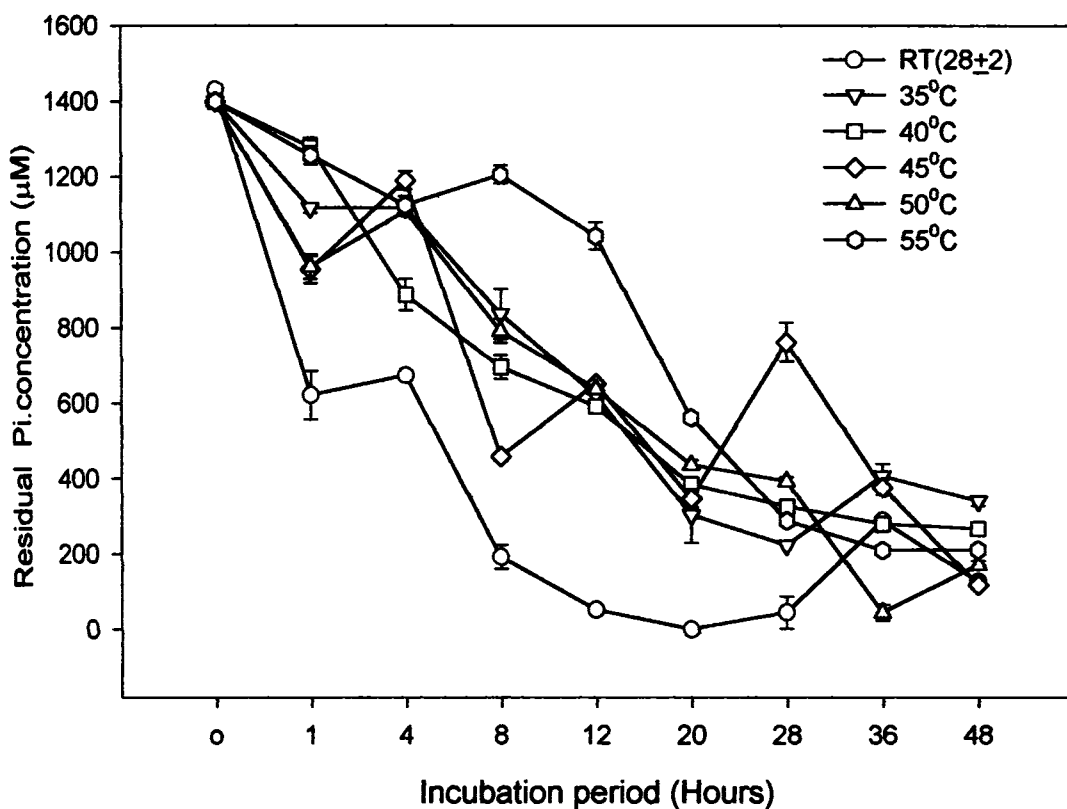

Fig.17 Effect of temperature on polyphosphate(polyP) accumulation by *Vibrio* sp BTDW-128 during growth in Zobell's marine broth (ZMB)

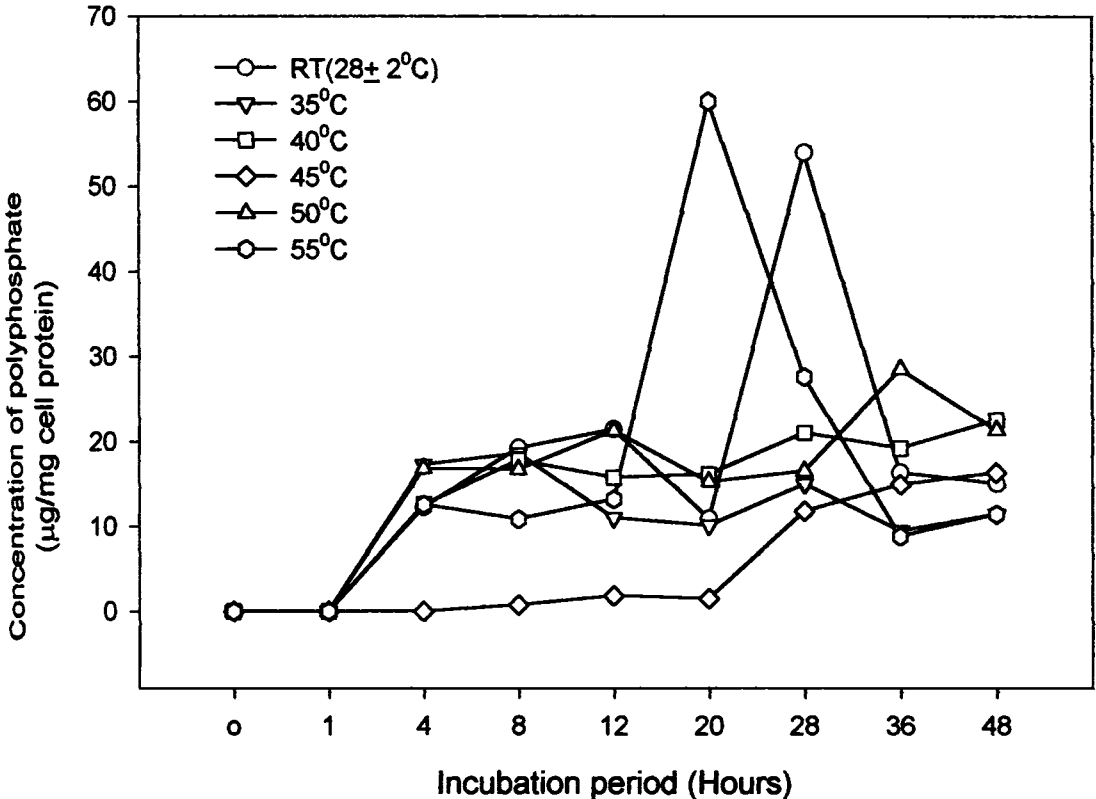

Fig.17 Effect of temperature on polyphosphate(polyP) accumulation by *Vibrio* sp BTDW-128 during growth in Zobell's marine broth (ZMB)

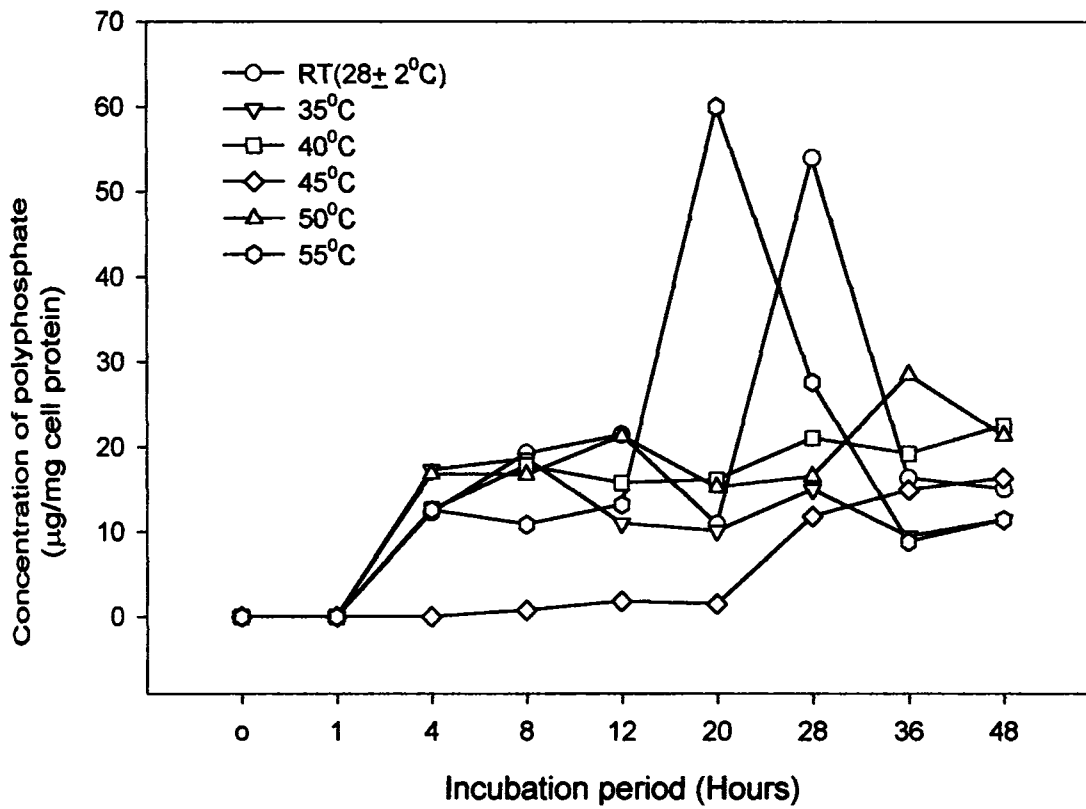

Fig.18 Effect of temperature on biomass, Pi uptake and polyphosphate (polyP) accumulation by *vibrio* sp BTDW-128 during growth in Zobell's marine broth(ZMB)

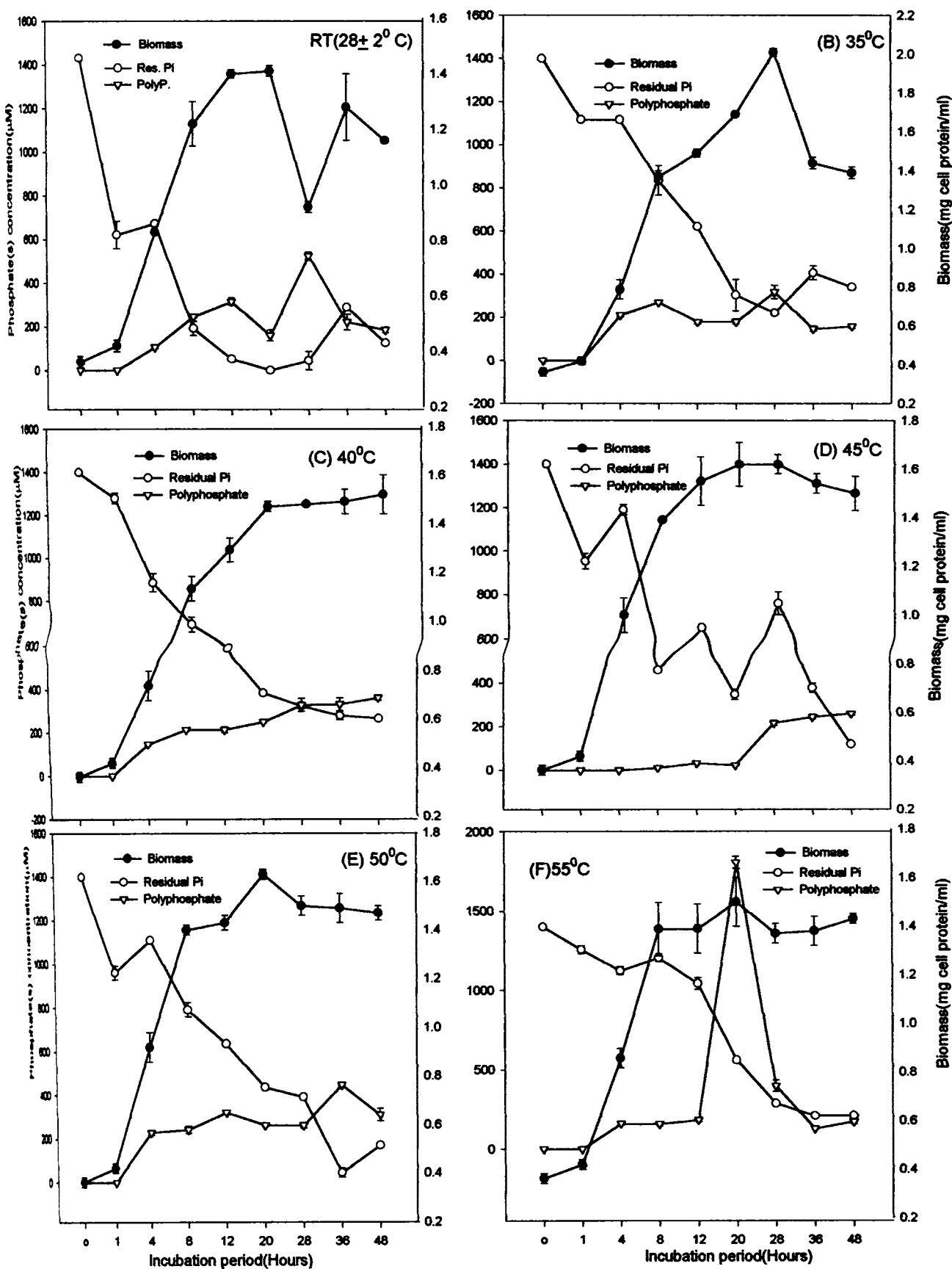

Fig.19 Effect of temperature on phosphate(Pi) uptake by *Achromobacter* sp BTDS-64, during growth in Zobell's marine broth(ZMB)

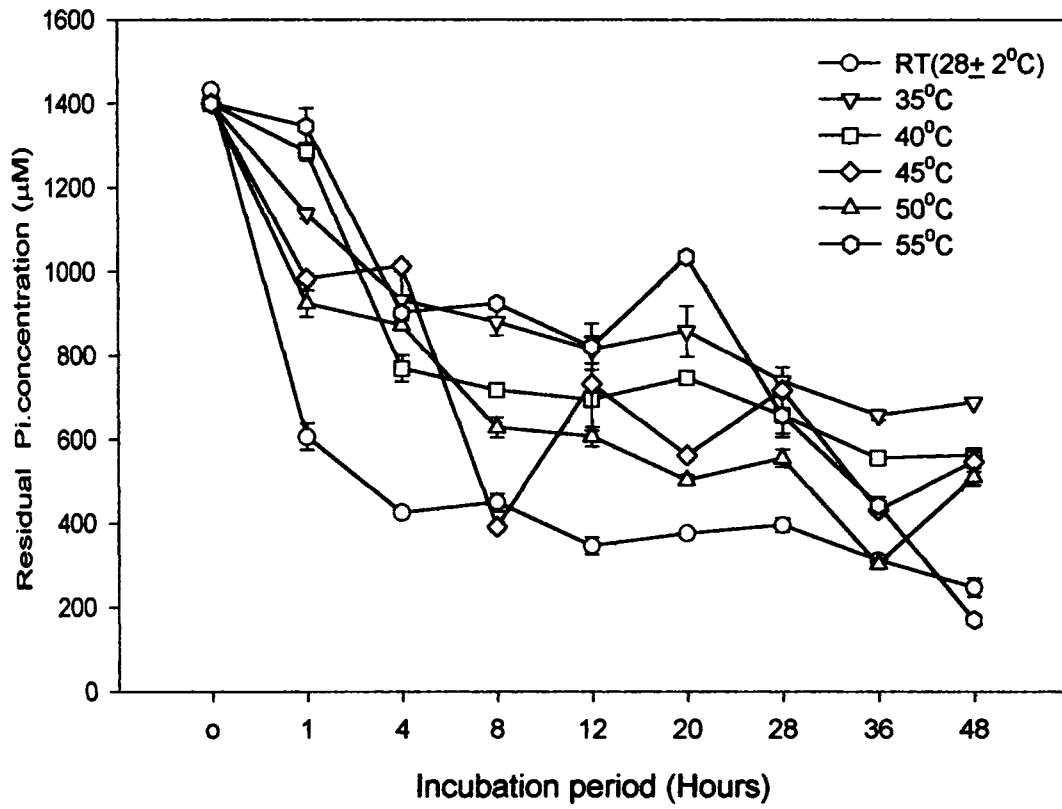

Fig.20 Effect of temperature on polyphosphate (polyP) accumulation by *Achromobacter* sp BTDS-64 during growth in Zobell's marine broth (ZMB)

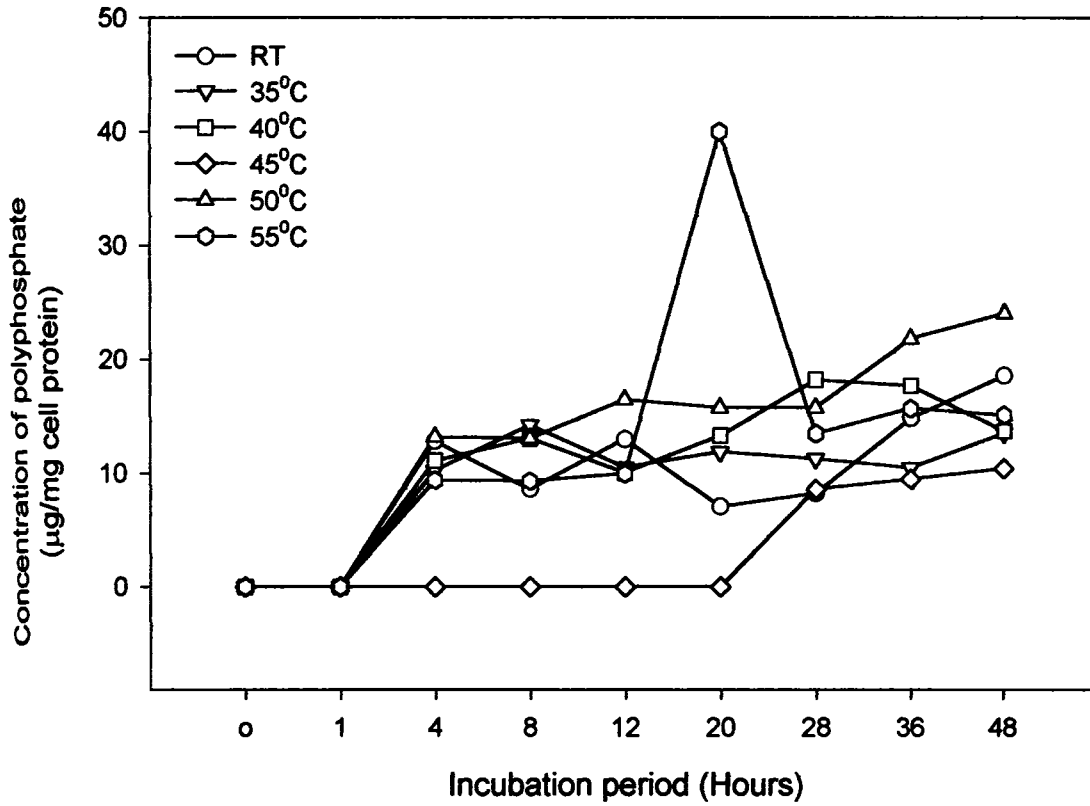
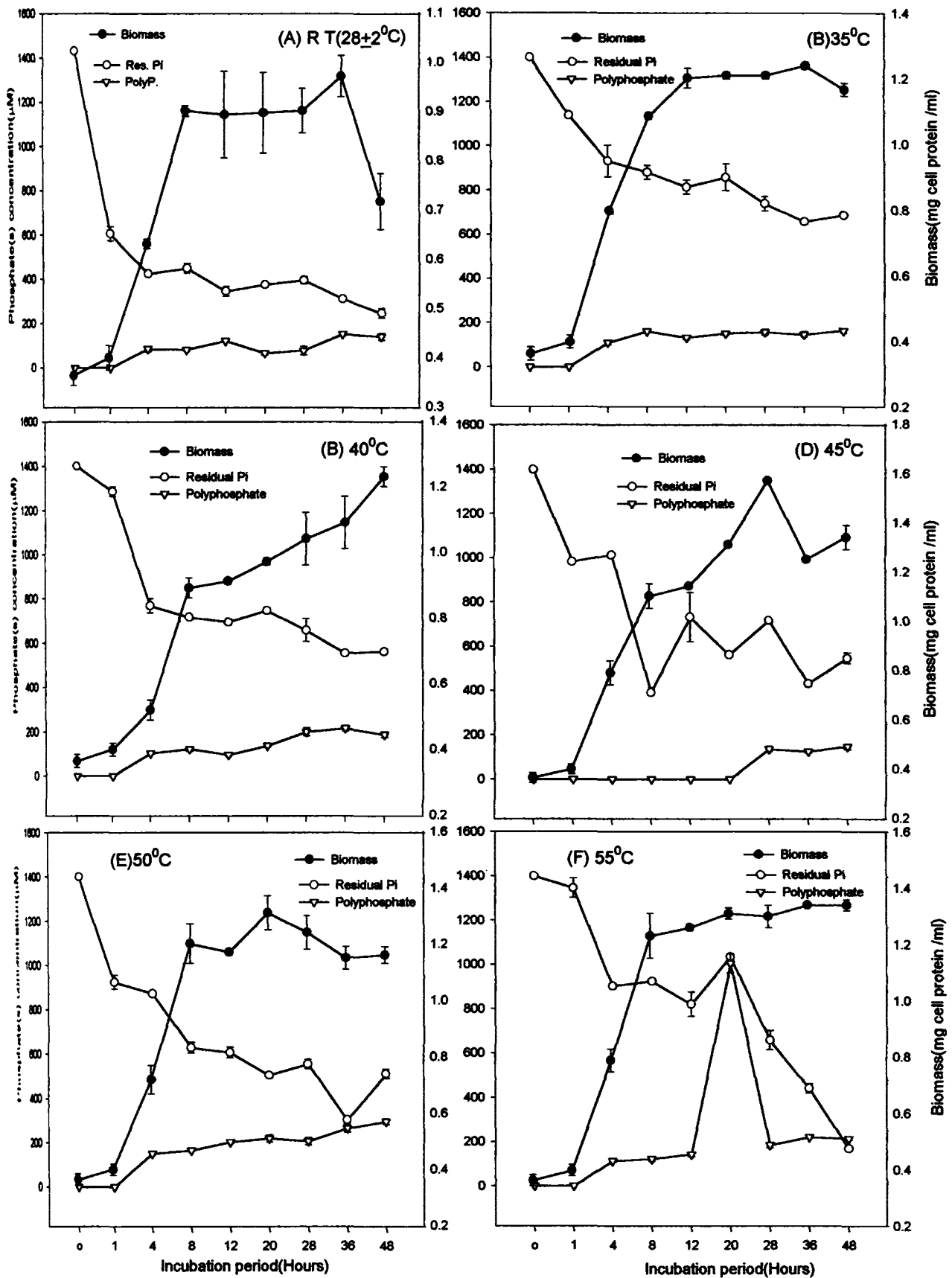

Fig.21 Effect of temperature on biomass, Pi uptake and polyphosphate (polyP) accumulation by *Achromobacter* sp. BTD-64 during growth in Zobell's marine broth (ZMB)



and 55°C there was concordant increase in both levels.

***Achromobacter* sp**

Data presented in **Fig.19**, suggest that irrespective of the incubation temperatures, there was rapid Pi uptake during 0-1 hr and the Pi uptake continued till 4 hrs at 35°C, 40°C and 55°C. However, there was a marginal release of Pi at 45°C during 1-4 hrs. and at RT during 4-8 hrs. During subsequent period of incubation, there was fluctuation and there was marginal difference in the rate of Pi uptake for the different incubation temperatures. However there was release of Pi during 8-12 hrs at 45°C and 55°C during 12-20 hrs.

PolyP accumulation by *Achromobacter* sp showed identical trend irrespective of the incubation temperatures, except at 55°C. There was a steep increase in polyP accumulation during 12-20 hrs followed by a rapid decline during 20-28 hrs (**Fig.20**). At 45°C, polyP accumulation was recorded only during 20-28 hrs, unlike other temperatures.

From the data presented in **Fig. 21**, it is evident that there was interrelationship among the values of biomass, Pi uptake and polyP accumulation. Thus, at all higher incubation temperatures the rate of Pi uptake increased along with increase in biomass compared to RT, where both were lesser. Whereas, polyP, increased along with increase in Pi uptake and biomass at all the higher temperatures. Rate of Pi uptake remained almost stable after an initial increase during the course of incubation at all higher temperatures (35 - 55°C), except at 45°C where it fluctuated maximum throughout the period of incubation after 4 hr of incubation.

3.6 Effect of Sodium Chloride

***Vibrio* sp**

Presence of additional sodium chloride, in the cultivation medium (ZMB) had a direct impact on the rate of Pi uptake by *Vibrio* sp during their growth. From the data presented in Fig.22 it is also inferred that presence of NaCl in excess than in the original medium has reduced the availability of phosphate for Pi uptake, even at 0 hrs. Further, the data indicated Pi release into the medium during early hours of growth 0-4 hrs. However, irrespective of NaCl conc. in the cultivation medium, during 4-12 hrs residual Pi conc. in the medium declined indicating Pi uptake by actively growing cells. Further except in the case of 0.9M and 1.1M NaCl conc., where there was Pi release into the medium during 12-20 hrs., Pi levels declined in general during the later period of

Fig.22 Effect of NaCl on phosphate(Pi) uptake by *Vibrio* sp BTDW-128, during growth in Zobell's marine broth(ZMB)

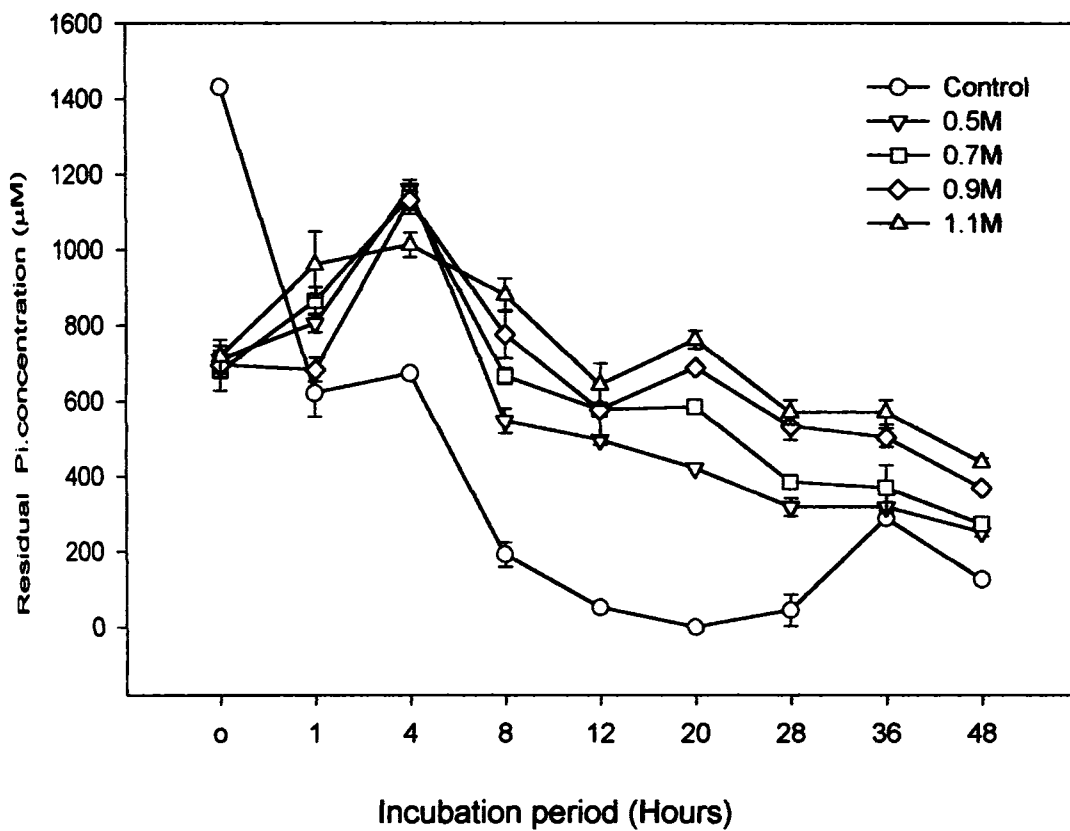

Fig.23 Effect of NaCl on polyphosphate(polyP) accumulation by *Vibrio* sp BTDW 128 during growth in Zobell's marine broth (ZMB)

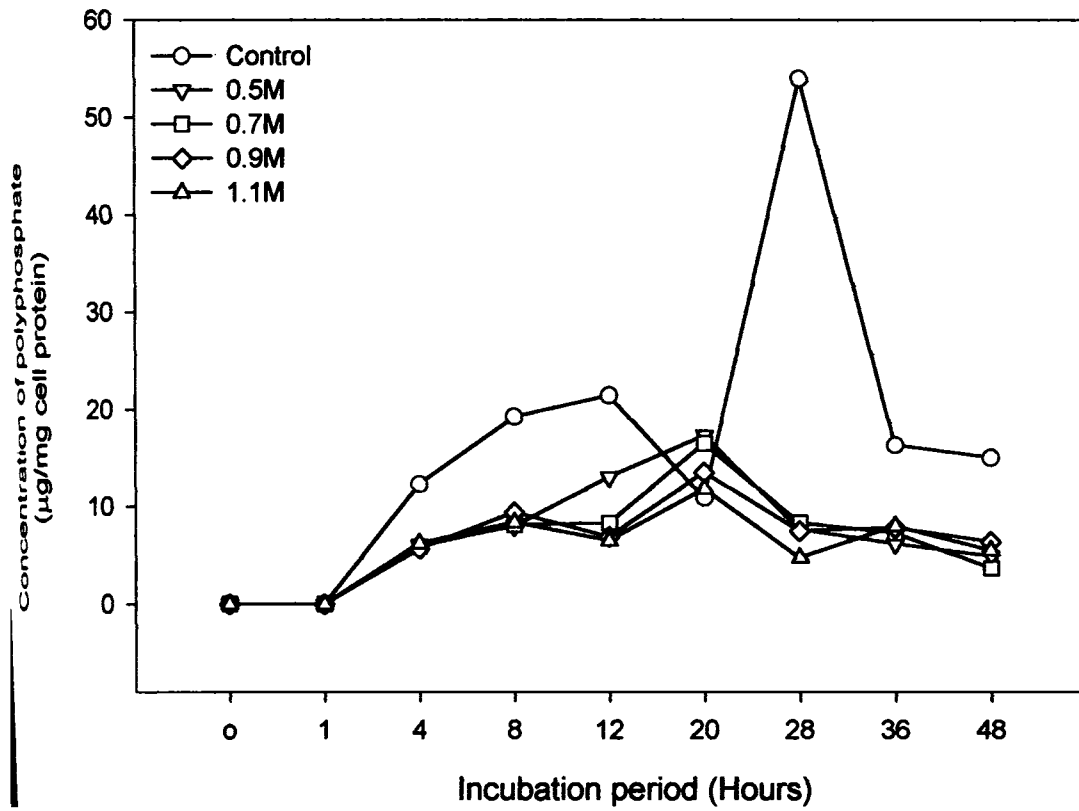
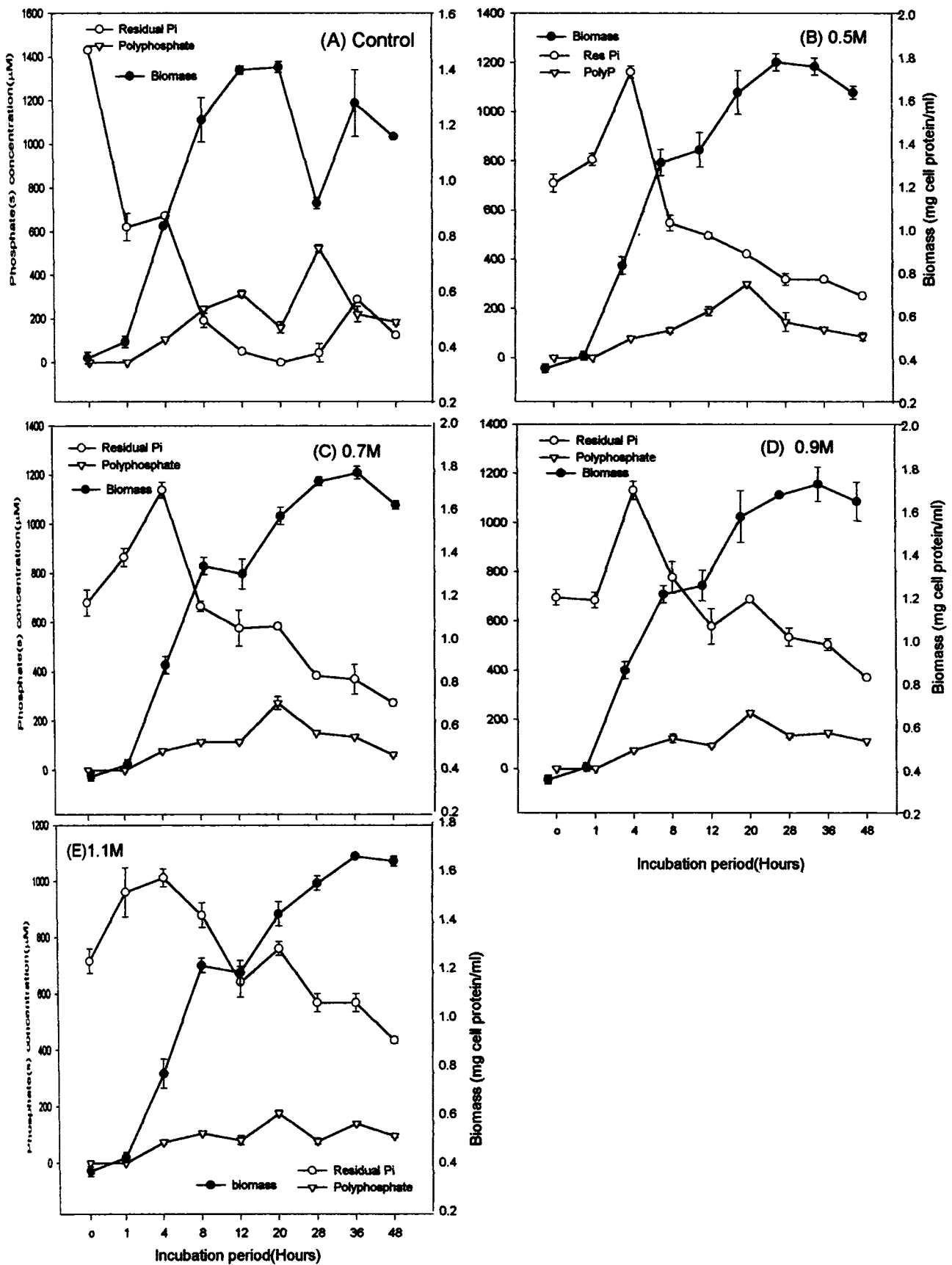

Fig.24 Effect of NaCl on biomass, Pi uptake and polyphosphate (polyP) accumulation by *Vibrio* sp BTDW-128 during growth in Zobell's marine broth(ZMB)



growth indicating Pi uptake. However, in the control medium there was rapid Pi release during 28-36 hrs.

Results presented in **Fig.23** suggest that the rate of polyP accumulation by *Vibrio* sp is affected by the presence of additional conc. of NaCl in the medium. At all levels of NaCl tested the polyP accumulation was at reduced level in spite of gradual increase in polyP accumulation. Further it was observed that while polyP got reduced during 12-20 hrs in the control medium, there was only increase in polyP levels in the presence of excess NaCl. During the subsequent period, 20-28 hrs, there was a reverse phenomenon of rapid increase in polyP in the control medium, while polyP declined at all the conc. of NaCl tested. In fact maximal polyP accumulation was recorded at 28 hrs.

Very interestingly, under the influence of NaCl conc. there was concordant increase in biomass and polyP associated with Pi release during 1-4 hrs (**Fig.24**). There was a proportionate increase in polyP along with increase in biomass during 1-8 hrs irrespective of the conc. of NaCl in the medium. However, the picture was different during 4-20 hrs such that polyP accumulation was associated with Pi uptake. It was also noted that polyP accumulation increased along with increase in biomass in the presence of additional NaCl in the medium.

***Achromobacter* sp**

Results depicted in **Fig. 25** very clearly evidence the impact of presence of additional NaCl in the medium on the rate of Pi uptake/release by the cells of *Achromobacter* sp. Thus, while there was rapid removal of Pi from medium in the control medium during 0-1 hr, at all the conc. of NaCl tested, there was release of Pi into the medium, which of course was taken up marginally by the cells during the subsequent 1-4 hrs. There was definite uptake of Pi during 4-12 hrs, which, however, was significantly very less compared to the control medium. Moreover, when compared to control medium, there was Pi uptake during exponential growth at high conc. of NaCl. In general, presence of excess conc. of NaCl in the medium resulted in reduction of Pi uptake by cells. The observations indicated clearly that *Achromobacter* sp is sensitive to presence of excess NaCl conc. in the medium and hence its Pi uptake efficiency is affected drastically.

From the data presented in Fig.26 it is inferred that the rate of polyP accumulation, which was maximal in the control medium, during 1- 4hrs, was drastically reduced due to the presence of additional sodium chloride in the medium. A contrasting scenario was observed during 12 – 28 hrs. While polyP accumulation declined during 12 – 20 hrs and increased marginally and rapidly during

Fig.25 Effect of NaCl on phosphate(Pi) uptake by *Achromobacter* sp BTDS-64, during growth in Zobell's marine broth(ZMB)

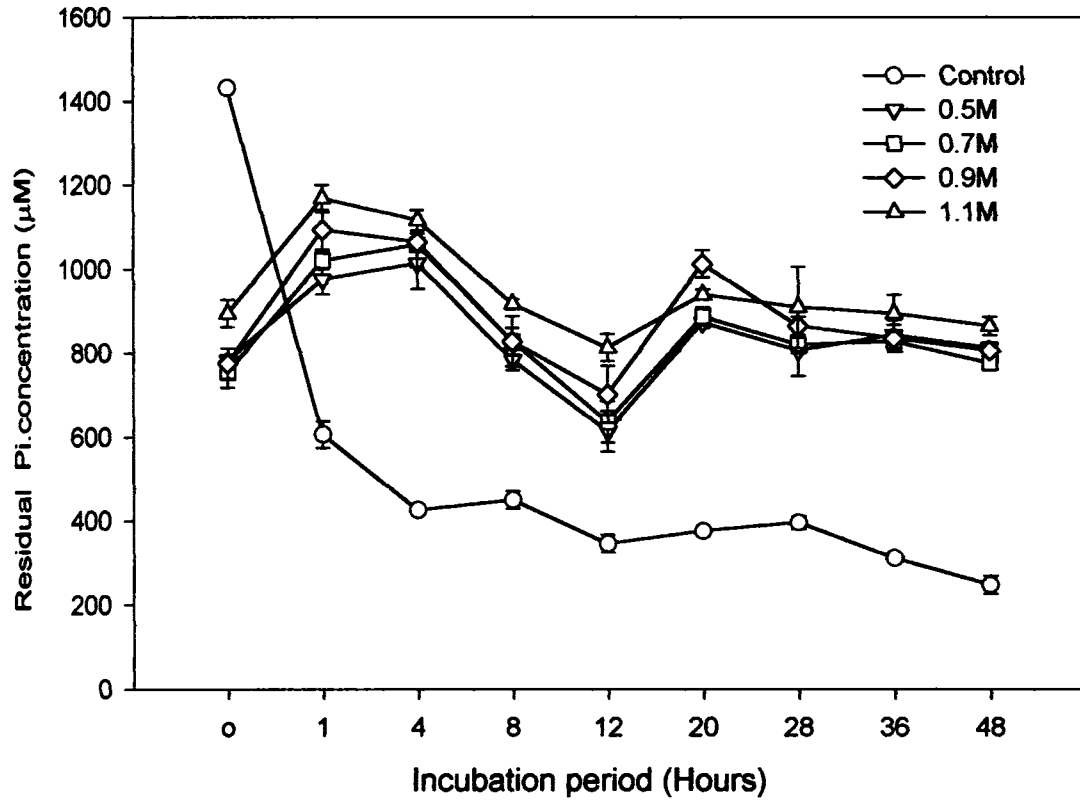

Fig.26 Effect of NaCl on polyphosphate (polyP) accumulation by *Achromobacter* sp BTDS-64 during growth in Zobell's marine broth (ZMB)

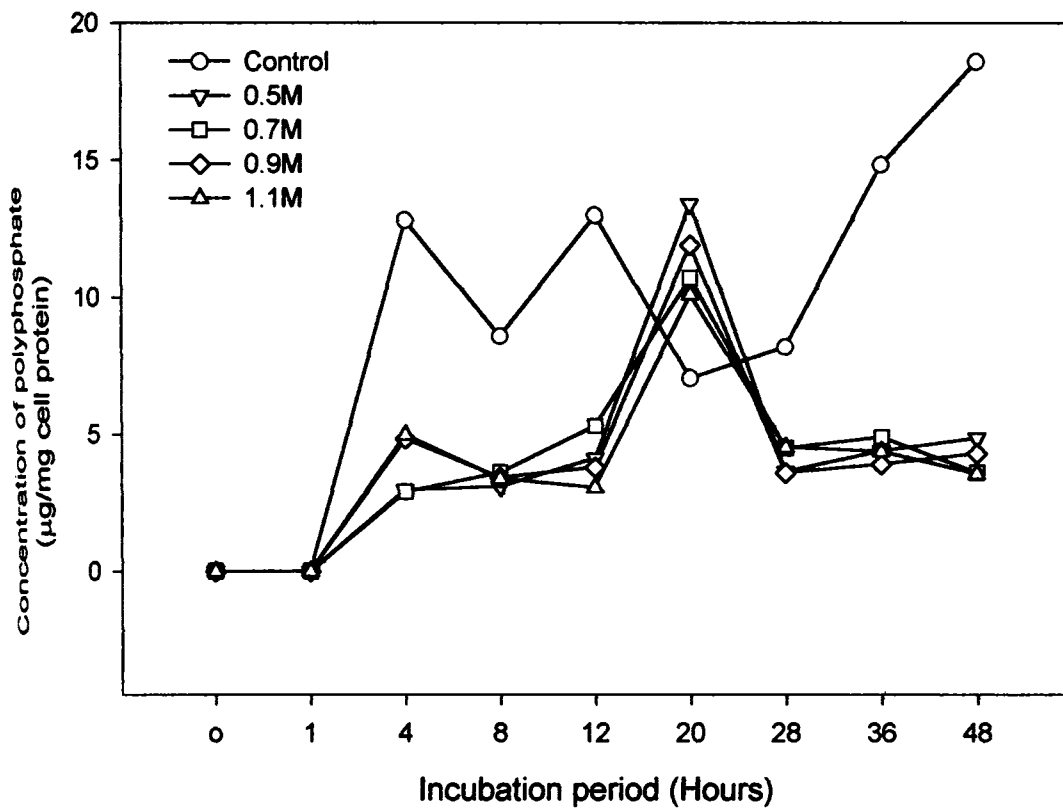
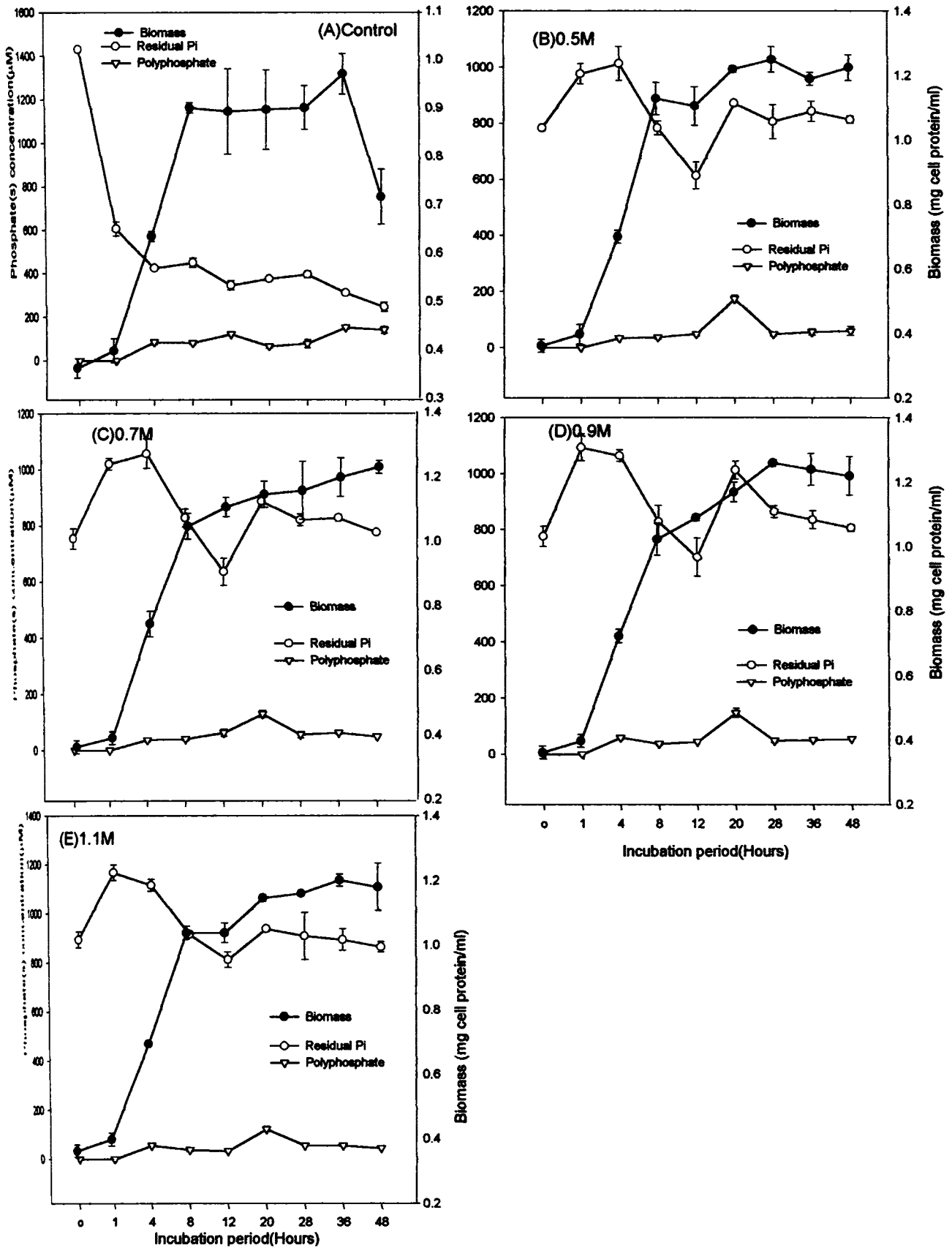

Fig.27 Effect of NaCl on biomass, Pi uptake and polyphosphate (polyP) accumulation by *Achromobacter* sp BTDS-64 during growth in Zobell's marine broth(ZMB)



20 – 28hrs and 28 – 48 hrs, respectively in the control medium, in the presence of sodium chloride. PolyP accumulation rapidly increased during 12 – 20 hours and declined drastically during subsequent 20 – 28 hours, followed by no change in the levels during 28 – 48 hours.

Interrelationship between biomass, Pi uptake and polyP accumulation by *Achromobacter* sp can be inferred from the data presented in Fig 27. Results presented very clearly evidence the impact of presence of additional sodium chloride in the medium on the interrelationship of the three variables. For instance, in the control medium at the time of rapid Pi uptake, during 1 – 4 hours, there was increase in biomass and polyP. Whereas, at the same time, in the presence of sodium chloride at conc. of 0.5 and 0.7M, the increase in biomass was associated with Pi release. Although there was Pi uptake at the same time at sodium chloride conc. of 0.9 and 1.1M, it was only marginal, when compared to that with control. Further, during 12 – 20 hrs of growth, irrespective of the sodium chloride conc. added to the medium, increase in biomass and polyP was associated with Pi release compared to Pi uptake in the control medium.

3.7 Other Inorganic Salts

3.7.1. Potassium Chloride (KCl)

Effect of Potassium Chloride, on the rate of Pi uptake and polyP accumulation by marine bacteria was studied and the data obtained for the various studies are presented in Figures 28-33.

Vibrio sp

From the data presented in **Fig.28** it is evident that the presence of additional conc. of KCl in the medium influenced the rate of Pi uptake by *Vibrio* sp, particularly during 4-12 hrs, such that there was no Pi uptake compared to that observed with the control, in which there was rapid Pi uptake. Of course there was identical pattern of Pi uptake irrespective of the initial conc. of KCl in the medium during 0-1 hr and 12-20 hrs, but for the difference that in the control the rate of Pi uptake was at enhanced level. Interestingly during 36-48 hrs, the residual Pi conc. increased in the presence of KCl indicating Pi release and declined in the absence of added KCl, indicating Pi uptake.

It could be inferred from the data depicted in **Fig.29** that presence of KCl in the medium did influence the rate of polyP accumulation by *Vibrio* sp. Thus when there was no polyP accumulation during 0-1 hr in the control medium and at KCl concentration varying from 0.014 M to 0.028 M, there was increase in polyP accumulation rate at KCl concentration of 0.035 M. Further, while

Fig.28 Effect of KCl on phosphate(Pi) uptake by *Vibrio* sp BTDW-128, during growth in Zobell's marine broth(ZMB)

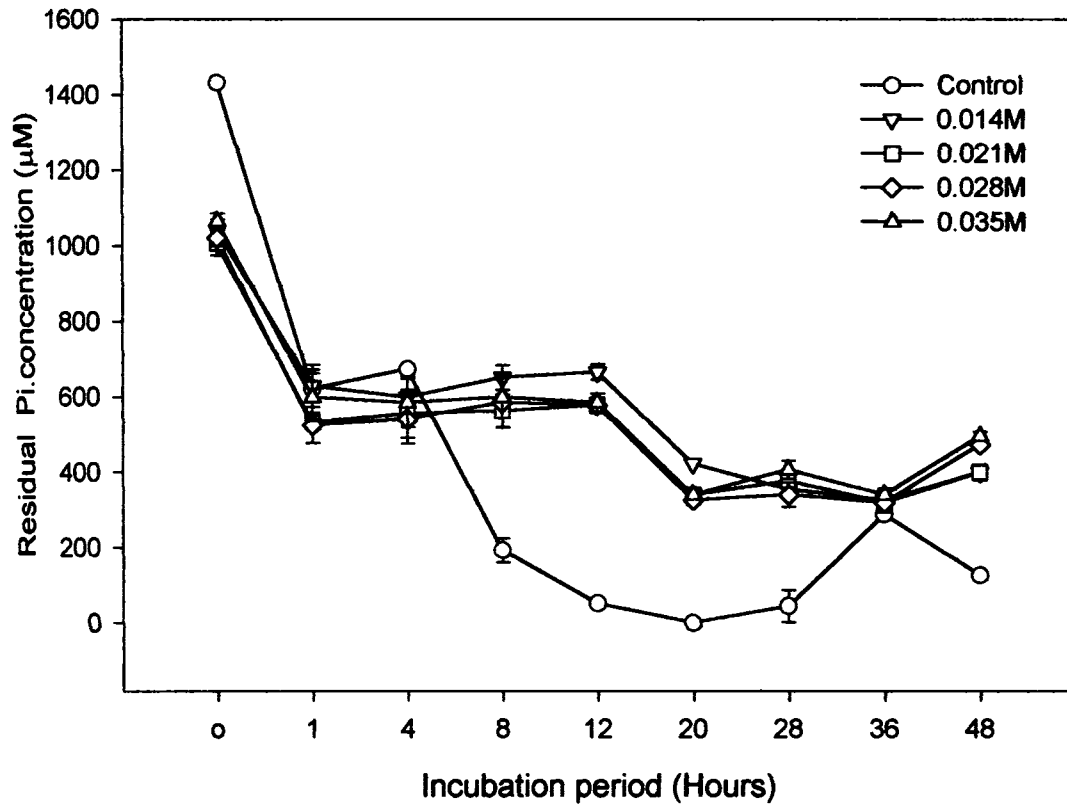

Fig.29 Effect of KCl on polyphosphate(polyP) accumulation by *Vibrio* sp BTDW-128 during growth in Zobell's marine broth (ZMB)

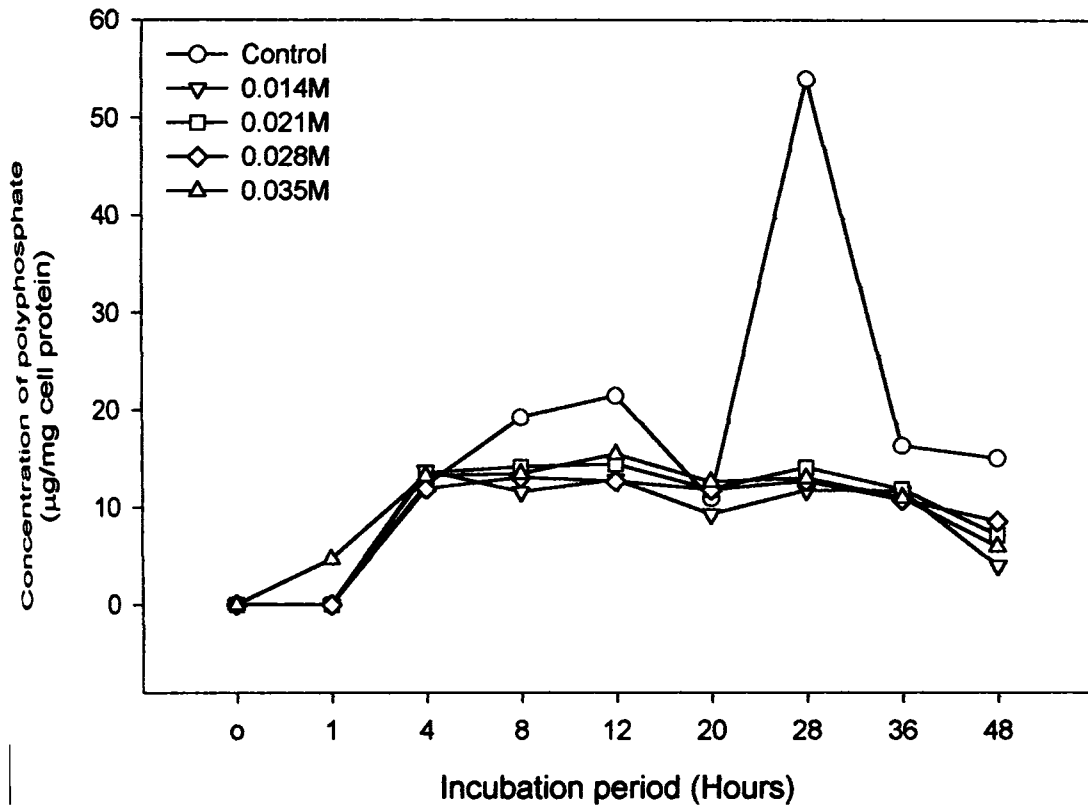
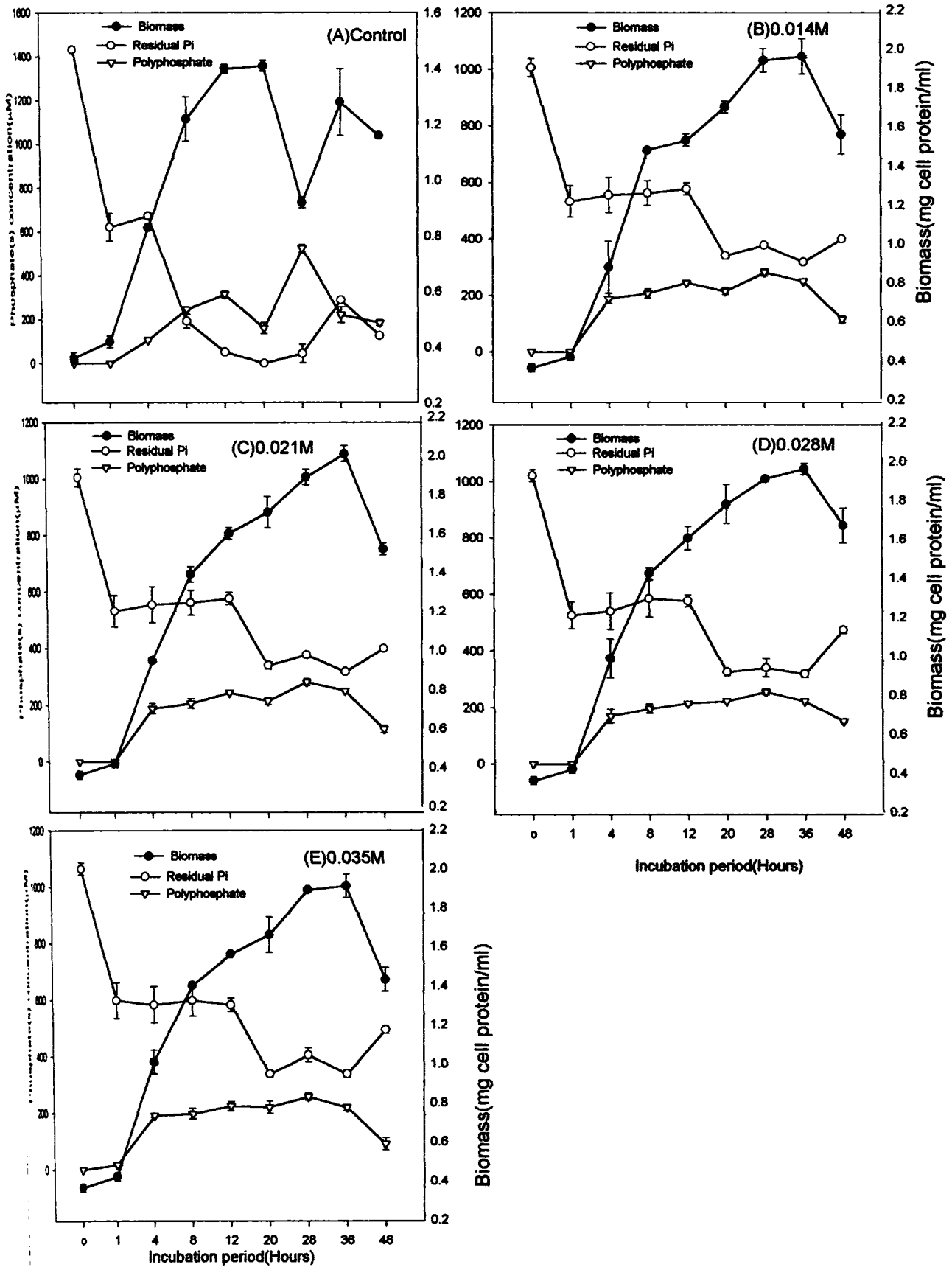

Fig.30 Effect of KCl on biomass, Pi uptake and polyphosphate (polyP) accumulation by *Vibrio* sp BTDW-128 during growth in Zobell's marine broth(ZMB)



there was high polyP accumulation in the control medium, presence of additional KCl in the medium retarded the rate of polyP accumulation during 1-4 hrs and during 20-28 hrs.

Interrelationship between biomass, Pi uptake and polyP accumulation by *Vibrio* sp could be deduced from the results presented in **Fig.30**. There was a very clear relationship between biomass and polyP irrespective of KCl conc. in the medium. At all the conc. of KCl tested increase in polyP was associated with increase in biomass, except in the control medium during 20-28 hrs., when there was a negative relationship. Interestingly, increase in polyP was associated with Pi release during 1-4 hrs at all KCl conc. tested except at 0.035 M KCl where there was neither Pi uptake nor Pi release. Only during 36-48 hrs the Pi uptake was associated with polyP accumulation in the presence of KCl, at all concentration except in the control medium. Further, it was also observed that during 20-36 hrs, increase in biomass, along with Pi uptake and decline in polyP, was recorded.

***Achromobacter* sp**

Presence of excess KCl in the cultivation medium drastically influenced the rate of Pi uptake by ***Achromobacter* sp** (**Fig.31**). Thus, although there was Pi uptake during 0-1 hr, comparatively it was at a lesser rate than that of control medium. Further, during the rest of the incubation period, 1-48 hrs, the residual conc. of Pi was recorded at higher level than the control evidencing the very clear impact of KCl on the efficiency of cells to uptake Pi from the medium. It was also observed that, in the presence of KCl in the medium there was an increase in the rate of Pi release during 1-12 hrs. Further, at very high conc. of KCl, 0.028 M and 0.035 M, there was rapid Pi uptake followed by Pi release during 28-36 hrs. compared to the contrasting observation made for 0.014 M and 0.021M.

While there was no polyP accumulation by ***Achromobacter* sp** in the control medium during 0-1 hr, the rate of polyP accumulation increased at higher conc. of KCl (0.028M and 0.035M) compared to other conc. (**Fig.32**). However, the rate of polyP accumulation was marginally affected during 1-4 hrs. Further, while polyP levels declined during 4-8 hrs in the control, there was gradual increase in polyP at other concentration of KCl.

From the data presented in **Fig.33**, it is clear that presence of KCl in the medium influenced the type of inter relation between the Pi uptake, polyP accumulation and biomass of ***Achromobacter* sp** during growth. While Pi uptake was associated with increase in biomass and polyP accumulation during 1-4 hrs at conc. of 0.014 M – 0.028 M KCl, Pi release was associated

Fig.31 Effect of KCl on phosphate(Pi) uptake by *Achromobacter* sp BTDS -64, during growth in Zobell's marine broth(ZMB)

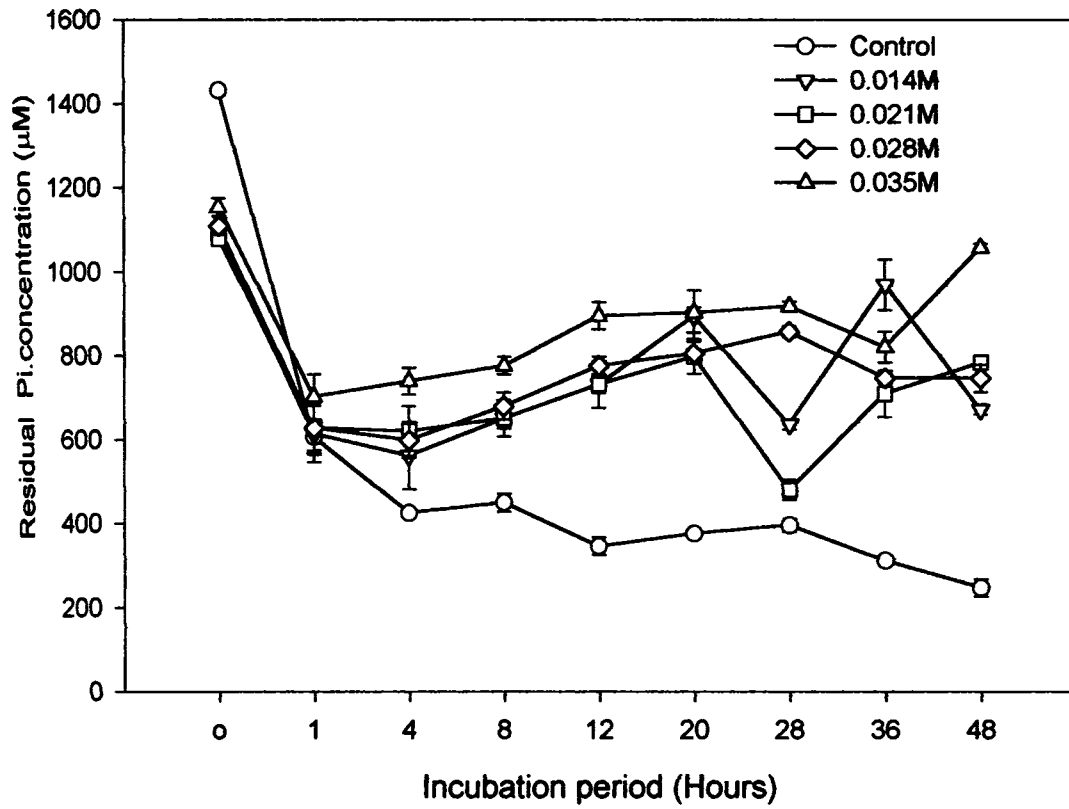

Fig.32 Effect of KCl on polyphosphate(polyP) accumulation by *Achromobacter* sp BTDS-64 during growth in Zobell's marine broth (ZMB)

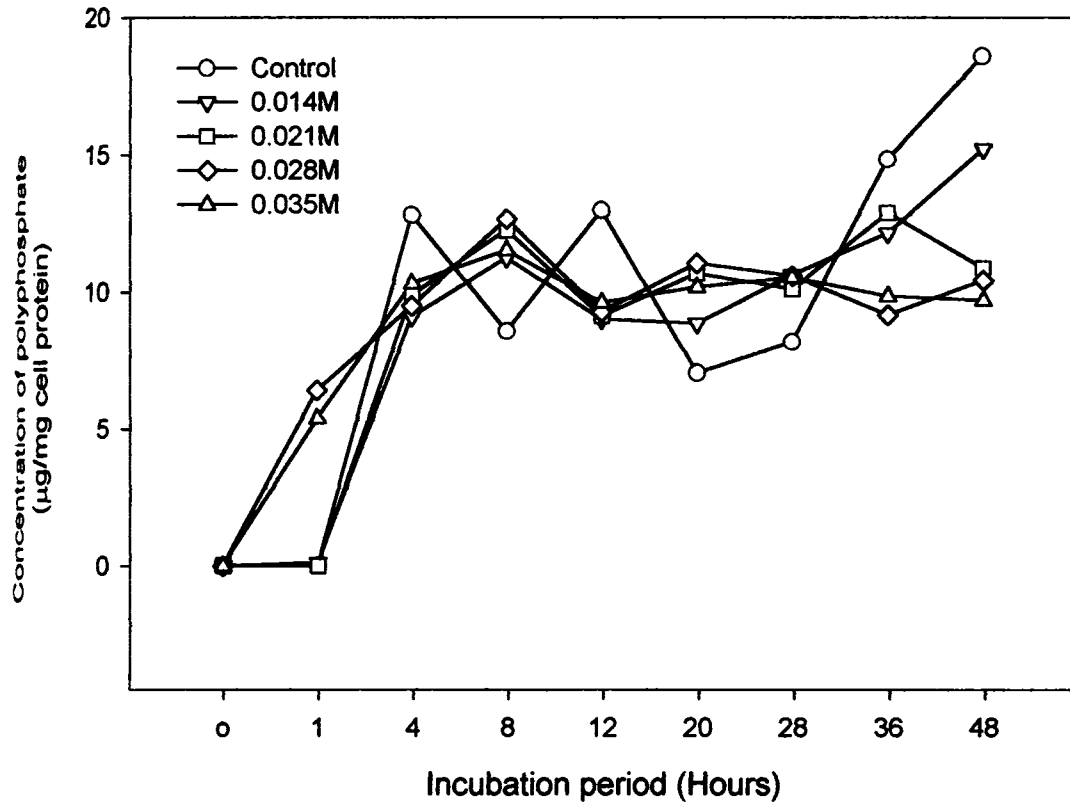
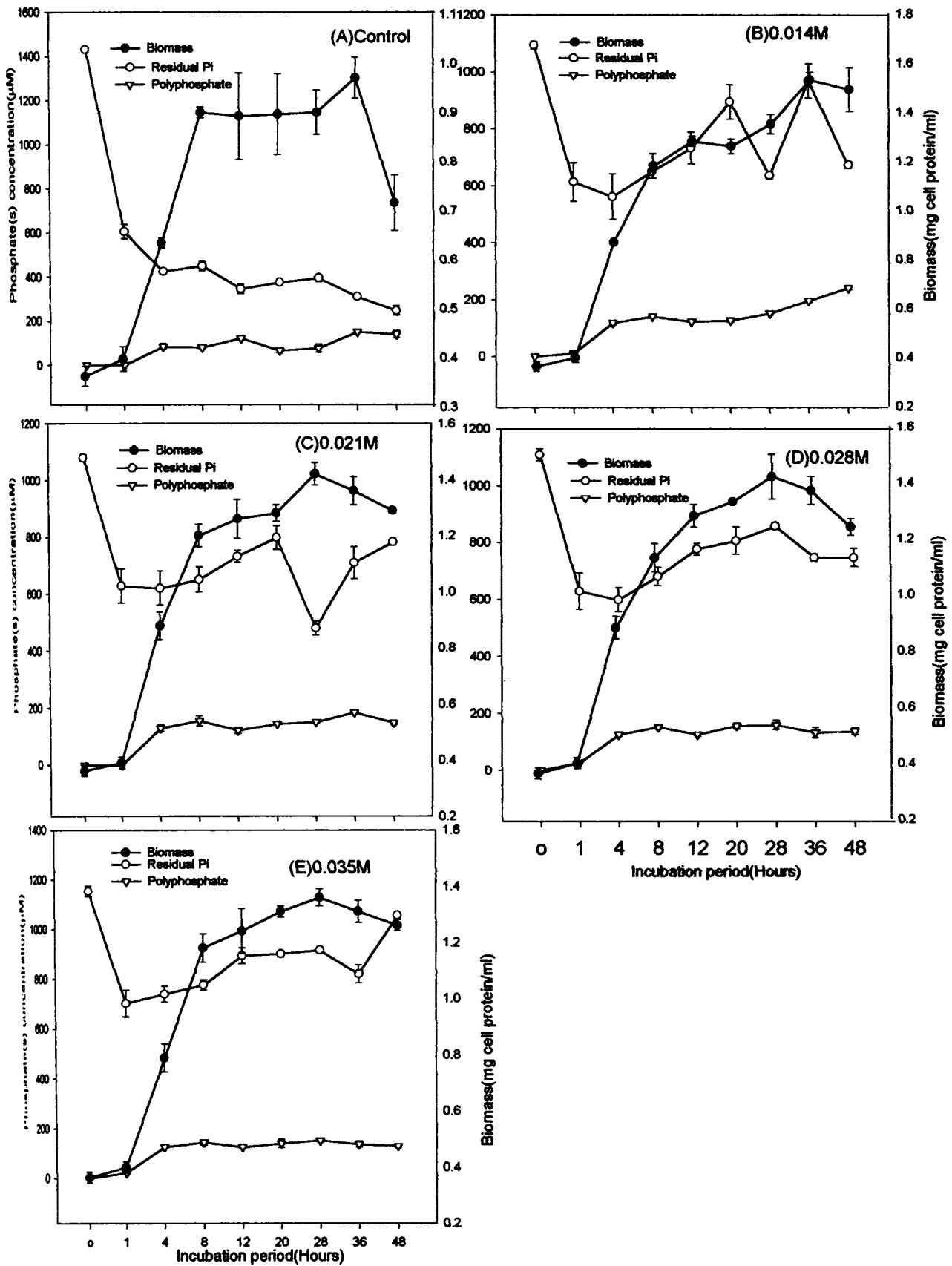

Fig.33 Effect of KCl on biomass, Pi uptake and polyphosphate (polyP) accumulation by *Achromobacter* sp BTDS-64 during growth in Zobell's marine broth(ZMB)



with increase in biomass and polyP at 0.035M KCl. In general, after an initial rapid Pi uptake during 0-1 hrs, there was Pi release, associated with increase in biomass. Increase in polyP was recorded only during 1-4 hrs, which remained almost stable during later hours, irrespective of the increase in Pi release and biomass at all the concentration of KCl tested, except at 0.014 M KCl where a gradual and marginal increase was observed. In fact polyP accumulation did not show any significant pattern, in response to KCl.

3.7.2 Calcium Chloride

Results obtained for the studies conducted on the effect of varying conc. of CaCl₂ on Pi uptake and polyP accumulation during growth by marine bacteria are presented in Fig. 34-39.

Vibrio sp

It could be seen that in the **Fig.34**, the residual initial conc. of Pi is not same for all the concentration of CaCl₂ tested. There was marked reduction in the original concentration of free Pi as low as 5-30 times compared to the control experiment. Results presented in the Fig. 34 strongly evidence the influence of excess CaCl₂ in the medium on the rate of Pi uptake, by *Vibrio* sp, since there was Pi uptake in the control medium. Further, during 1-4 hrs, while there was Pi release in the control medium, there was a marginal Pi uptake in the presence of 0.03M and 0.05M CaCl₂. Of course there was neither Pi release or Pi uptake detectable at high concentration of CaCl₂. Whereas, there was Pi uptake during 4-12 hrs irrespective of the presence or absence of excess CaCl₂ in the medium and almost a minimal residual Pi was recorded for all the experiments. Later hours of incubation did not show any significant change in the Pi uptake pattern.

Presence of excess conc. of CaCl₂ in the medium did not effect any variation in the rate of polyP accumulation by *Vibrio* sp (**Fig.35**) and almost identical levels of polyP accumulation was recorded for the various concentration of CaCl₂ tested and the control, during 0-4 hrs. However, unlike the control medium where there was only a very marginal reduction and subsequent increase respectively during 4-8 hrs and 8-12 hrs, presence of CaCl₂, irrespective of the conc. resulted in rapid decline and subsequent rapid increase in polyP level, respectively during 4-8 hrs and 8-12 hrs. Nevertheless, there was varying response in polyP accumulation pattern during 20-36 hrs. PolyP declined uniformly, irrespective of the conc. of CaCl₂ tested during 12-20 hrs and 36-48 hrs, when impact of CaCl₂ was not noticed.

From the data presented in **Fig. 36** it is inferred that presence of CaCl₂ influenced the relationship among the biomass, Pi uptake and rate of polyP accumulation by *Vibrio* sp during

Fig.34 Effect of CaCl_2 on phosphate(Pi) uptake by *Vibrio* sp BTDW-128, during growth in Zobell's marine broth(ZMB)

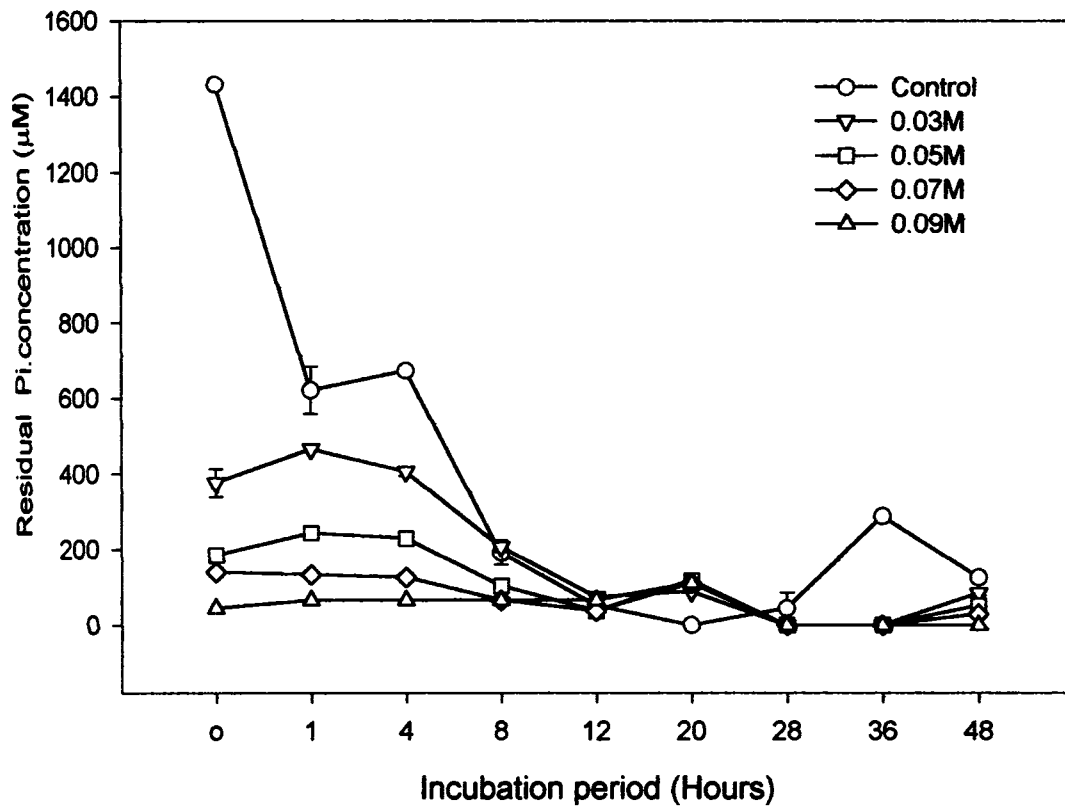

Fig.35 Effect of CaCl_2 on polyphosphate(polyP) accumulation by *Vibrio* sp BTDW-128 during growth in Zobell's marine broth (ZMB)

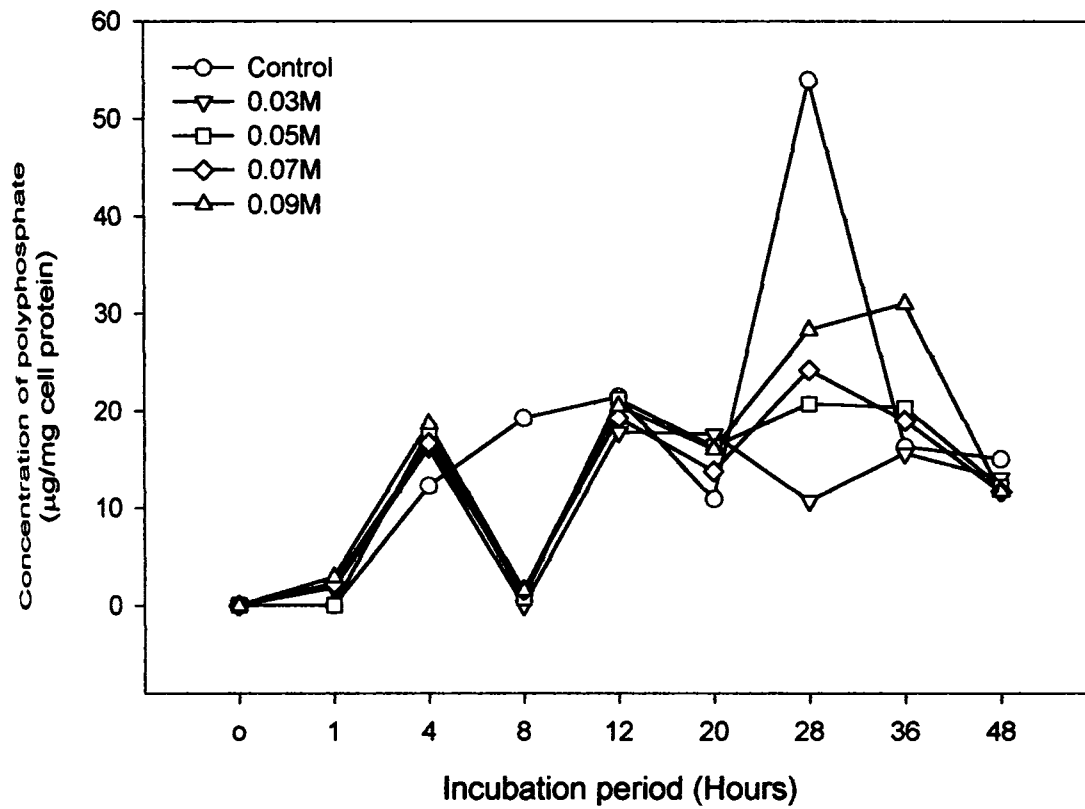
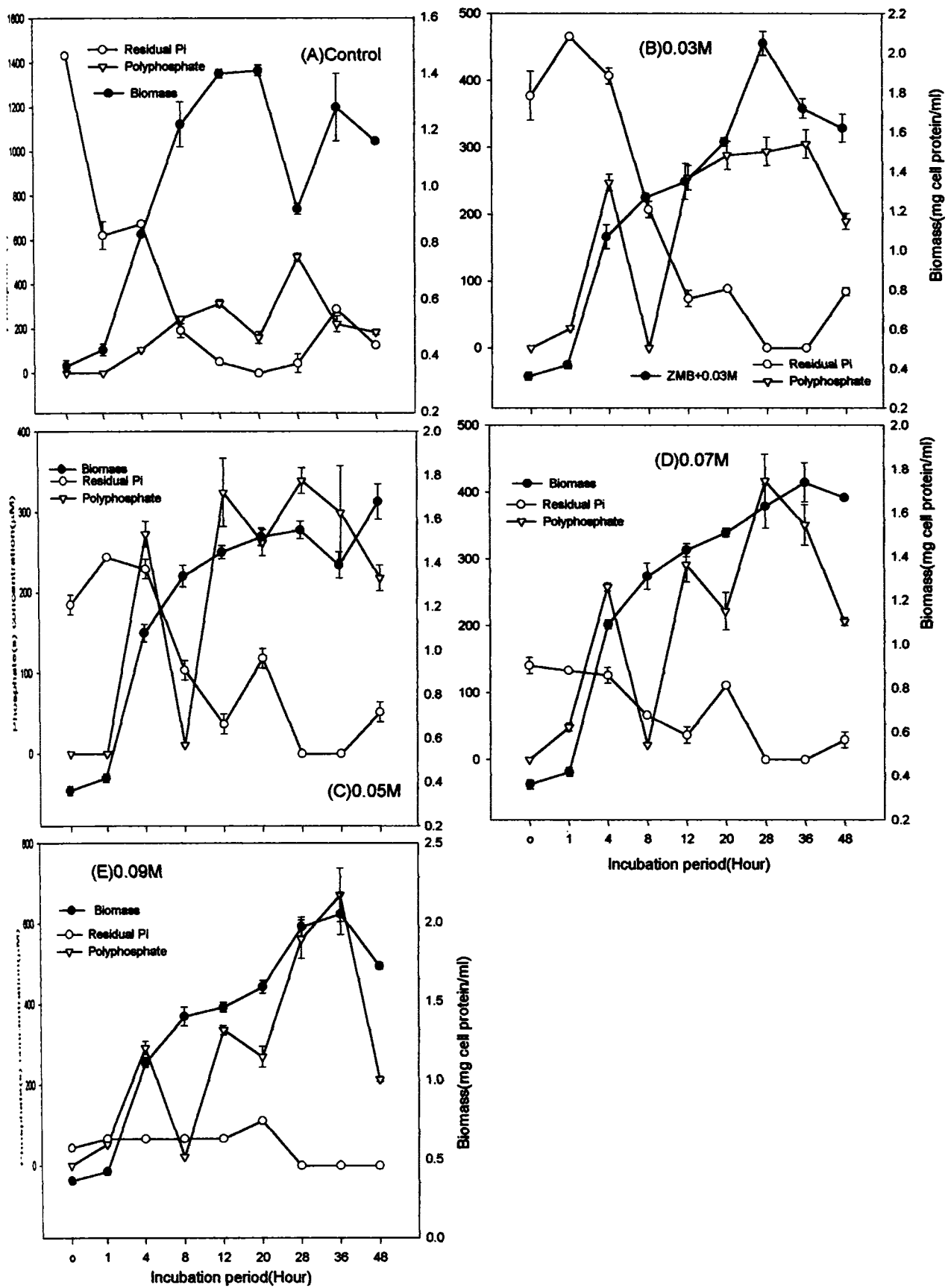

Fig.36 Effect of CaCl₂ on biomass, Pi uptake and polyphosphate (polyP) accumulation by *Vibrio* sp BTDW-128 during growth in Zobell's marine broth(ZMB)



growth. Response of cells to varying conc. of CaCl_2 was very evident. While there was P_i uptake in the control medium, during 0-1 hr along with marginal increase in biomass, in the presence of CaCl_2 in excess, there was P_i release along with marginal increase in biomass at 0.03M and 0.05M CaCl_2 . Although there was release of P_i during 0-1 hr at 0.03M and 0.05M CaCl_2 , during subsequent period of 1-12 hrs, there was rapid P_i uptake associated with increase in polyP and biomass, except during 4-8 hrs when the polyP declined. Of course decline in polyP along with increase in biomass and P_i uptake was recorded at all conc. of CaCl_2 except in the control during 4-8 hrs. While biomass recorded stable levels of increase during 12-36 hrs, P_i uptake and polyP showed wide fluctuations of increase and decrease, in the presence of excess conc. of CaCl_2 when compared to control.

Achromobacter sp

Very much like that observed with *Vibrio sp*, initial conc. of residual free P_i in the medium at the commencement of the experiment was very much reduced in the presence of increasing conc. of CaCl_2 (Fig.37). Further, the data presented in Fig.37 very clearly indicated the strong influence of CaCl_2 on the rate of P_i uptake by the cells of *Achromobacter*, such that almost there was no apparent P_i uptake except for the marginal P_i release and uptake respectively during 12-20 hrs and 20-28 hrs. In fact almost an identical pattern of P_i uptake was noticed irrespective of the conc. of CaCl_2 during 4-48 hrs.

Data presented in Fig.38 suggested that there was marginal increase in polyP accumulation during 0-4 hr, in the presence of excess CaCl_2 , when compared to control, in which there was no polyP accumulation. Further, irrespective of the conc. of CaCl_2 in the medium, there was rapid increase and decrease in polyP accumulation respectively during 1-4 hrs and 4-8 hrs. In fact, in the presence of excess CaCl_2 conc., there was total disappearance of polyP compared to that of control. However, during the subsequent period of 8-12 hrs, there was very high increase in polyP accumulation, higher than the control medium. Of course, during the later hours, (12-36 hrs) polyP levels remained almost stable without much variation. Whereas, in the control there was increase in polyP, during 28-48 hrs, in contrast to the decline in polyP during 36-48 hrs, in the presence of excess CaCl_2 in the medium.

From the results presented in Fig.39, it is evident that excess CaCl_2 in the medium marginally enhanced biomass, since maximal biomass recorded at the various conc. of CaCl_2 was higher compared to that of control. Increase in P_i uptake was associated with increase in biomass,

Fig.37 Effect of CaCl₂ on phosphate(Pi) uptake by *Achromobacter* sp BTDS-64, during growth in Zobell's marine broth(ZMB)

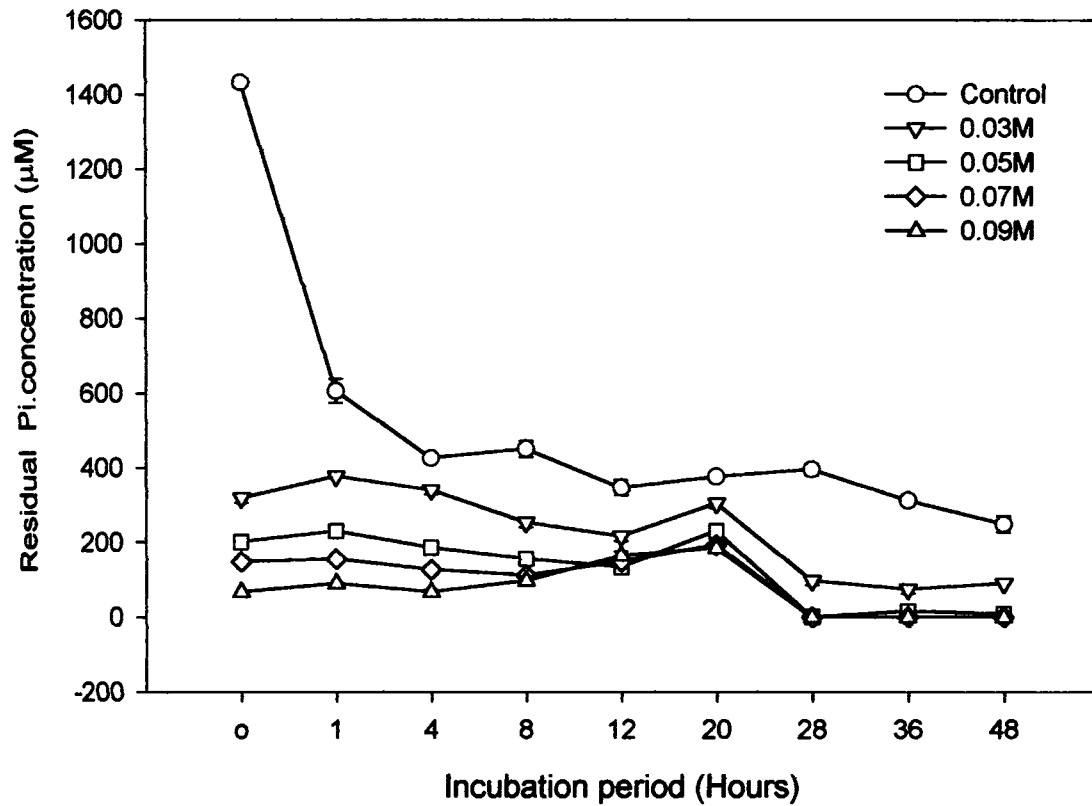

Fig.38 Effect of CaCl₂ on polyphosphate(polyP) accumulation by *Achromobacter* sp BTDS-64 during growth in Zobell's marine broth (ZMB)

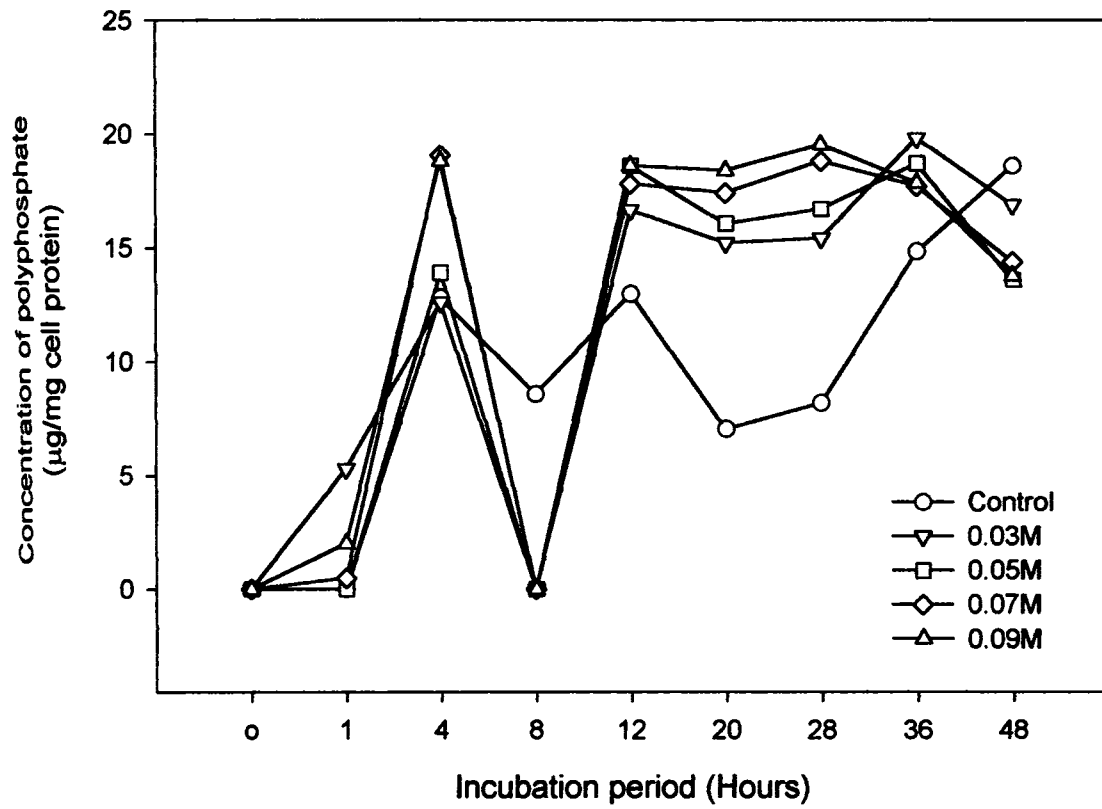
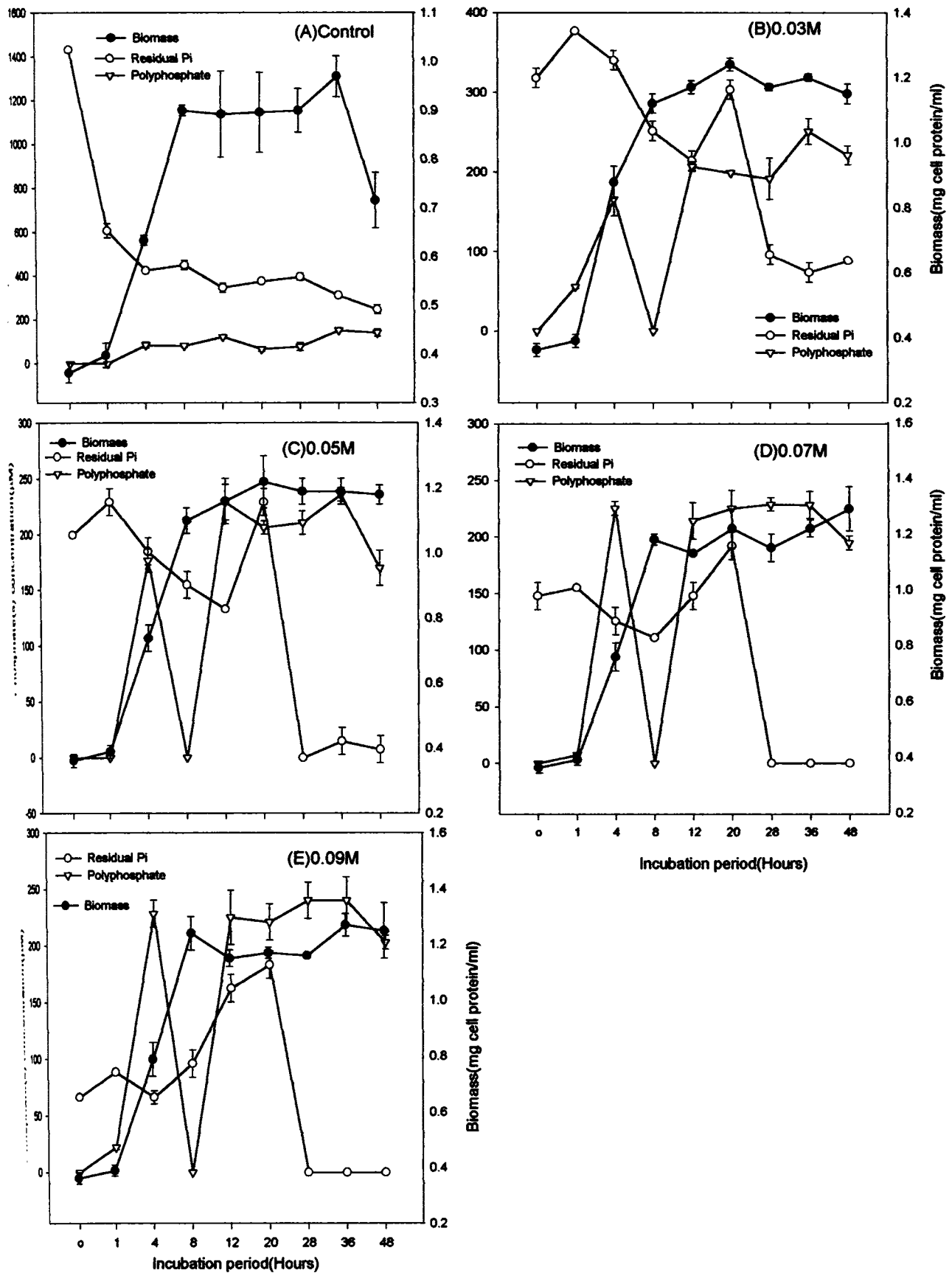

Fig.39 Effect of CaCl₂ on biomass, Pi uptake and polyphosphate (polyP) accumulation by *Achromobacter* sp BTDS-64 during growth in Zobell's marine broth(ZMB)



irrespective of the concentration of CaCl_2 tested, during 1-12 hrs, except at 0.09M CaCl_2 when there was Pi release along with increase in biomass during 4-12 hrs. Invariably polyP accumulation followed a trend of increase along with increase in biomass and Pi uptake during 1-4 hrs, irrespective of the conc. of CaCl_2 . However, unlike that in the control medium, in the presence of excess, CaCl_2 , there was rapid decline in polyP almost to nil during 4-8 hrs. Nevertheless, at all the concentration of CaCl_2 tested, polyP rapidly increased in the cells during the subsequent 8-12 hrs period. Second instance of increase in polyP was recorded along with increase in biomass and Pi uptake at conc. of 0.03M and 0.05M CaCl_2 , and decrease in biomass and Pi release at 0.07M and 0.09M CaCl_2 .

3.7.3 Magnesium Sulphate

Results obtained for the various studies conducted on the effect of Magnesium Sulphate on Pi uptake and Pi release by marine bacteria are presented in Fig.40-45.

Vibrio sp

The initial conc. of free Pi in the medium, was observed to be higher and increased along with increase in conc. of MgSO_4 tested (Fig.40). In the presence of MgSO_4 there was significant and proportionate increase in the initial free Pi in the medium and there was no Pi uptake by *Vibrio* sp during 0-1 hr, unlike that in the control where there was rapid Pi uptake. However, in contrast to that in the control where there was marginal Pi release during 1-4 hrs followed by Pi uptake, at all the conc. of MgSO_4 tested the residual Pi conc. declined progressively during the entire period of incubation indicating Pi uptake. Of course the level of Pi uptake decreased along with increase in initial conc. of MgSO_4 .

Interestingly the rate of polyP accumulation recorded almost a uniform pattern of increase and decline, irrespective of the conc. of MgSO_4 added to the medium, during the course of the experiment (Fig.41). However, during 20-28 hrs, in the control medium there was sudden and rapid decline immediately during 28-36 hrs. Variation in the polyP levels were relatively lesser compared to that of control medium, in which maximal polyP was recorded at 28 hrs. It was also observed that at 0.3M conc. of MgSO_4 there was polyP accumulation while there was no polyP accumulation at other instances.

From the data presented in Fig.42 it is inferred that presence of additional MgSO_4 in the medium influenced Pi uptake by cells of *Vibrio* sp during the lag phase since there was release of Pi into the medium. At all the conc. of MgSO_4 tested, increase in polyP accumulation was

Fig.40 Effect of MgSO₄ on phosphate(Pi) uptake by *Vibrio* sp BTDW 128, during growth in Zobell's marine broth(ZMB)

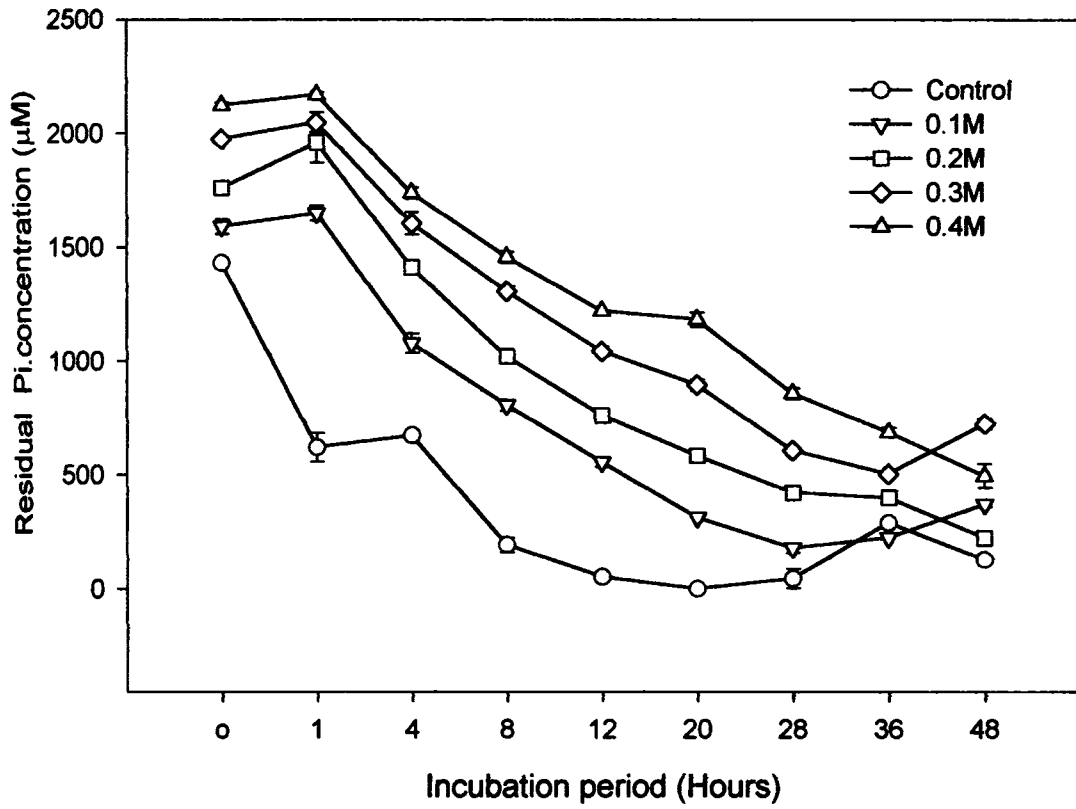
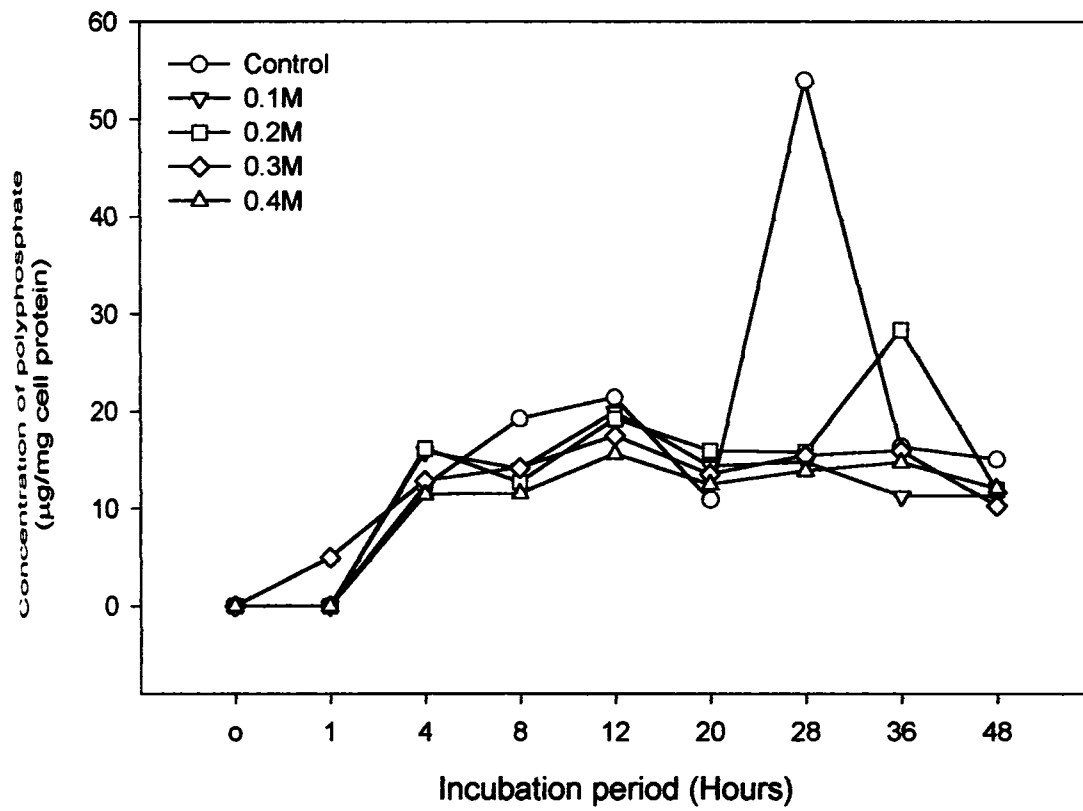

Fig.41 Effect of MgSO₄ on polyphosphate(polyP) accumulation by *Vibrio* sp BTDW-128 during growth in Zobell's marine broth (ZMB)



g.42 Effect of MgSO₄ on biomass, Pi uptake and polyphosphate (polyP) accumulation by *Vibrio* Sp BTDW-128 during growth in Zobell's marine broth(ZMB)

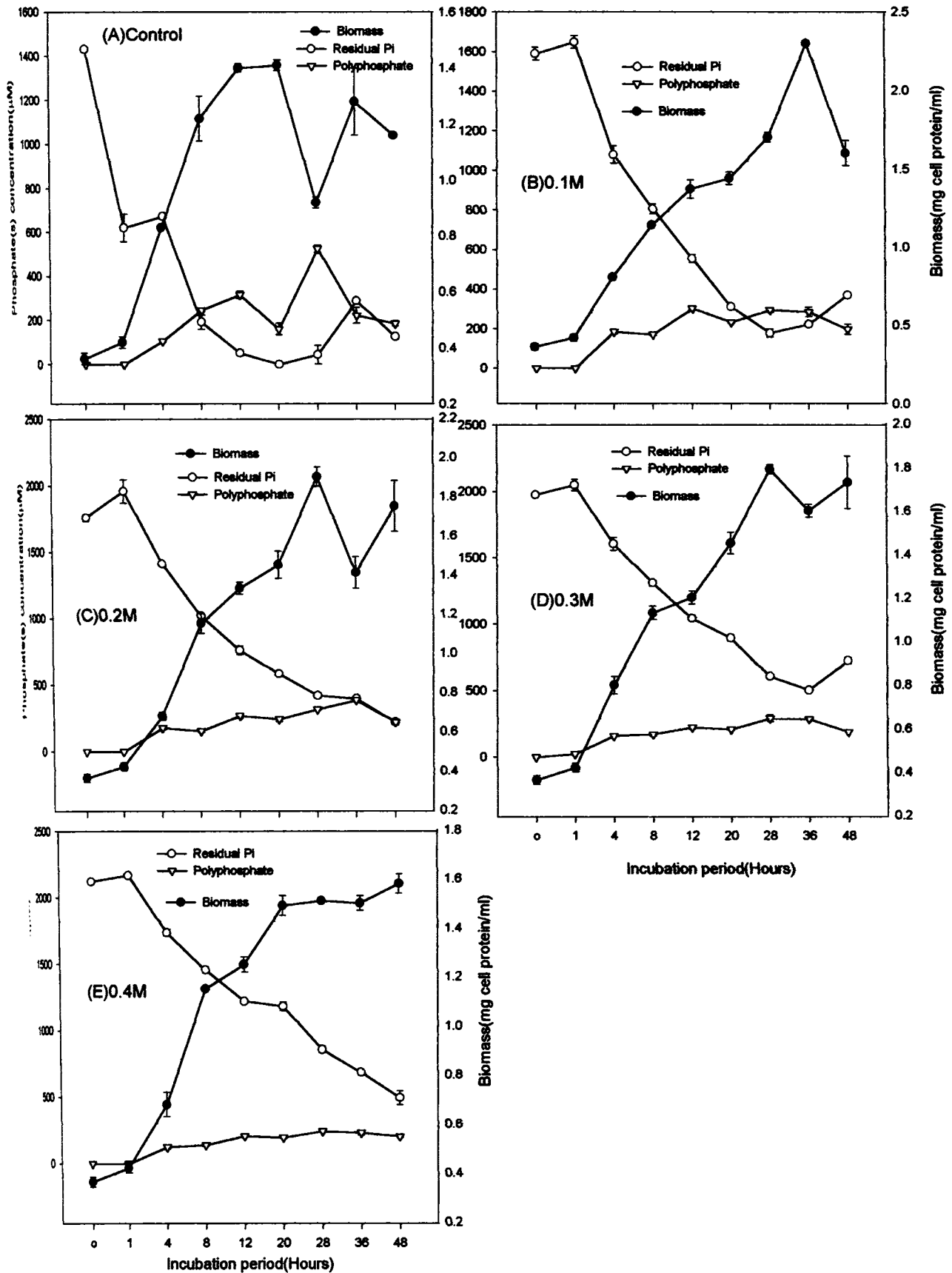

Fig.43 Effect of MgSO₄ on phosphate(Pi) uptake by *Achromobacter* sp BTDS-64, during growth in Zobell's marine broth(ZMB)

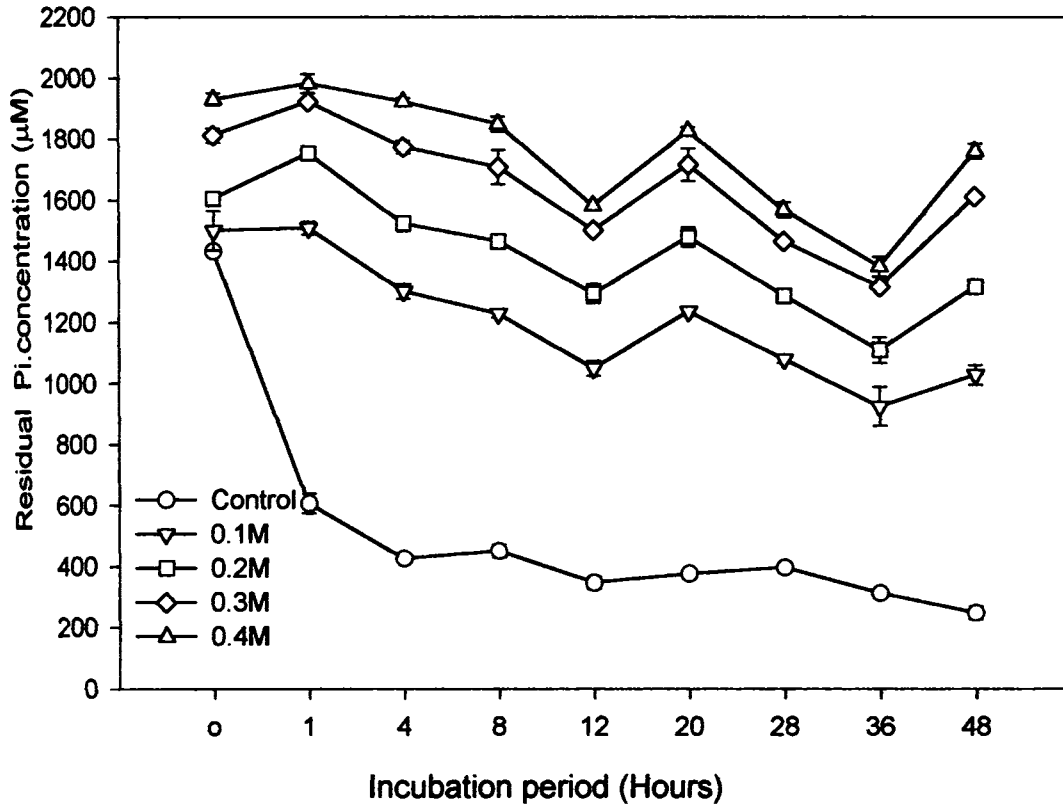
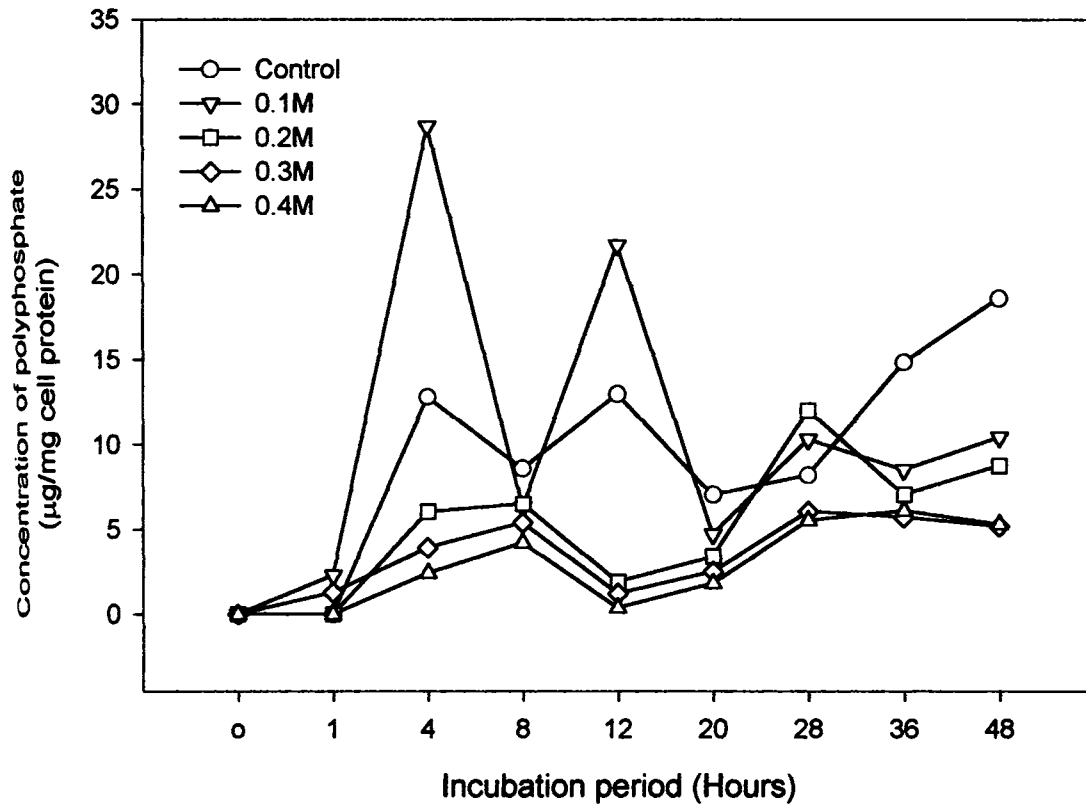

Fig.44 Effect of $MgSO_4$ on polyphosphate(polyP) accumulation by *Achromobacter* sp BTDS-64 during growth in Zobell's marine broth (ZMB)



associated with increase in biomass and increase in Pi uptake during 1-4 hrs, except in the control in which there was a marginal Pi release. It was observed that increase in Pi uptake was associated with increase in biomass irrespective of the conc. of MgSO₄. Level of polyP accumulation in response to conc. of MgSO₄ showed fluctuation and was not significant. Interestingly in the presence of MgSO₄ increase in polyP accumulation was associated with increase in Pi uptake.

Achromobacter sp

Data presented in Fig.43 indicated that MgSO₄ added at various conc. to the medium affected the rate of Pi uptake by *Achromobacter*, such that the rate is very much reduced, compared to control. Rate of reduction was proportionate with increase in the conc. of MgSO₄ added into the medium. Irrespective of MgSO₄ conc. in the medium, residual Pi declined during 1-12 hrs and 20-36 hrs, and increased during 12-20 hrs and 36-48 hrs unlike that observed with control.

Higher conc. of MgSO₄ in the medium strongly affected the rate of polyP accumulation during incubation compared to that in the control medium (Fig.44). Maximal level of polyP was recorded in the cells at 1-4 hrs at 0.1M MgSO₄, which of course rapidly declined during 4-8 hrs. The rate of polyP recorded with 0.1M MgSO₄ was higher when compared to the control, which subsequently declined during 12-20 hrs. At other instances there was wide range of fluctuation in polyP levels.

Increase in the rate of Pi uptake was recorded along with increase in biomass irrespective of the conc. of MgSO₄ in the medium during 1-8 hrs (Fig.45). Similarly the increase in the rate of polyP accumulation also was associated with increase in Pi uptake and increase in biomass.

3.7.4 Sodium Citrate

Results obtained for the studies conducted on the impact of sodium citrate on Pi uptake and polyP accumulation by marine bacteria are presented in Fig. 46-51.

Vibrio sp

It was observed that addition of sodium citrate to the medium reduced the availability of free Pi in the medium for uptake at 0hr itself when compared to that in the control medium (Fig.46). Results presented in Fig.50 evidence the impact of sodium citrate on Pi uptake by cells of *Vibrio* during 0-4 hrs. While there was rapid Pi uptake during 0-1 hr in the control medium there was

Fig.46 Effect of sodium citrate on phosphate(Pi) uptake by *Vibrio* sp BTDW-128, during growth in Zobell's marine broth(ZMB)

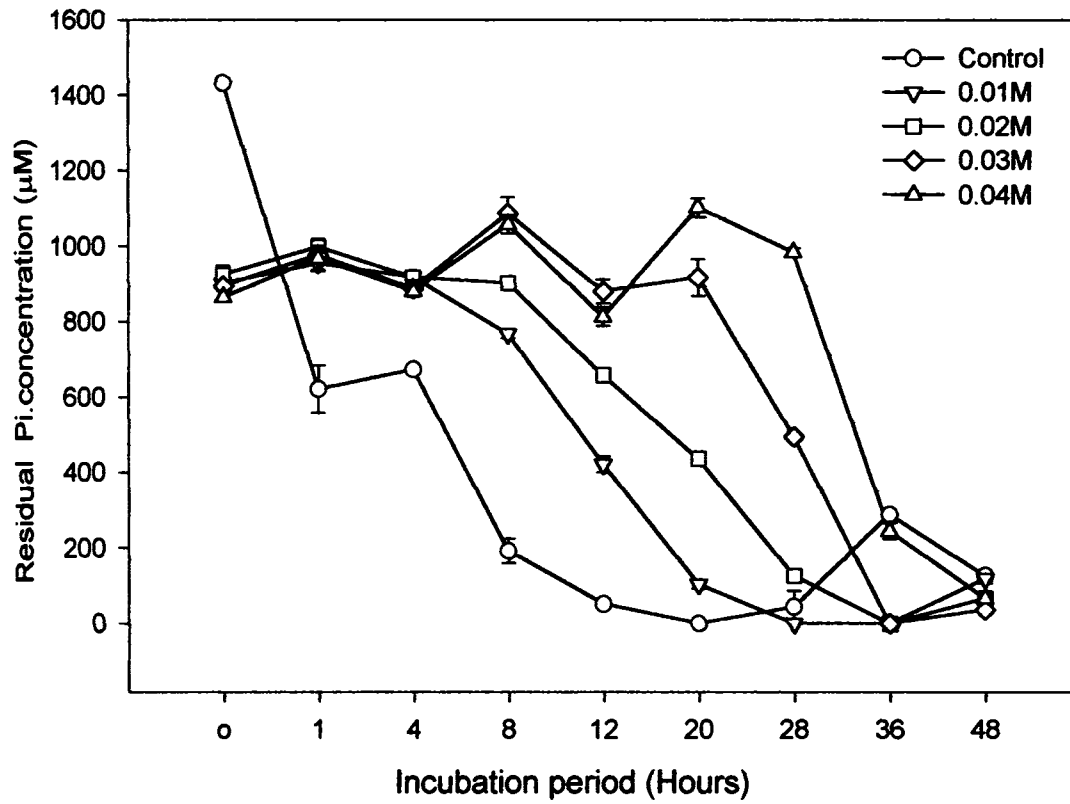

Fig.47 Effect of sodium citrate on polyphosphate(polyP) accumulation by *Vibrio* sp BTDW-128 during growth in Zobell's marine broth (ZMB)

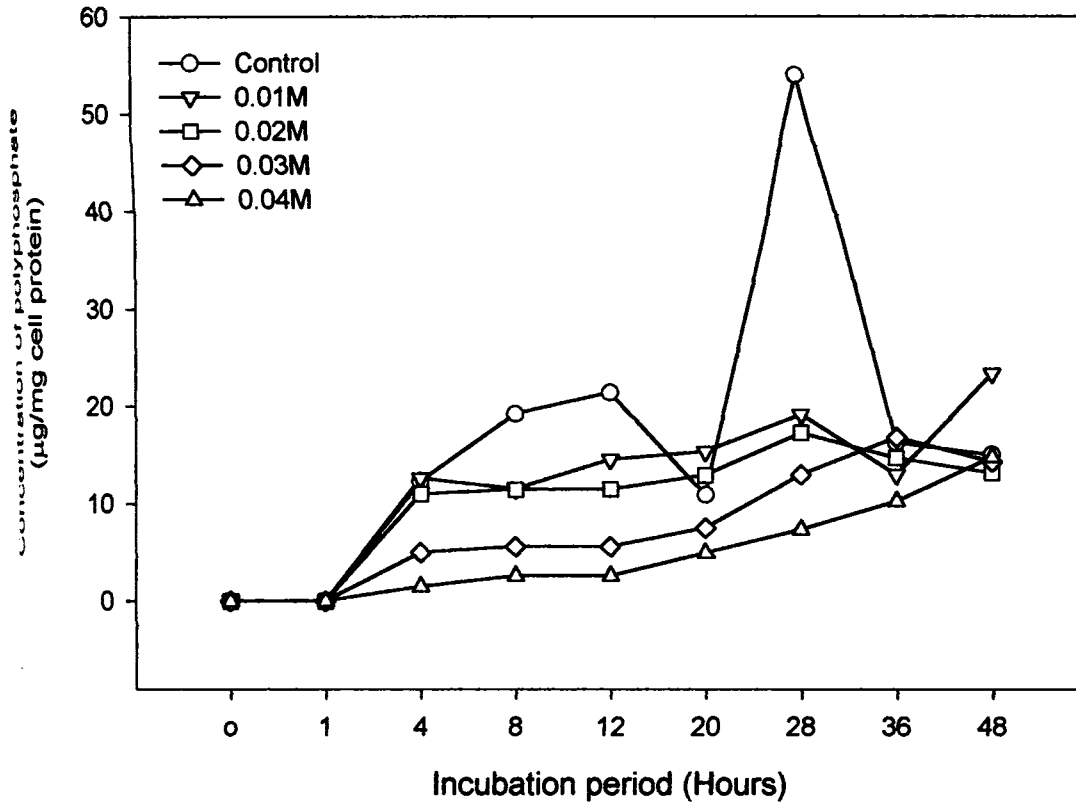
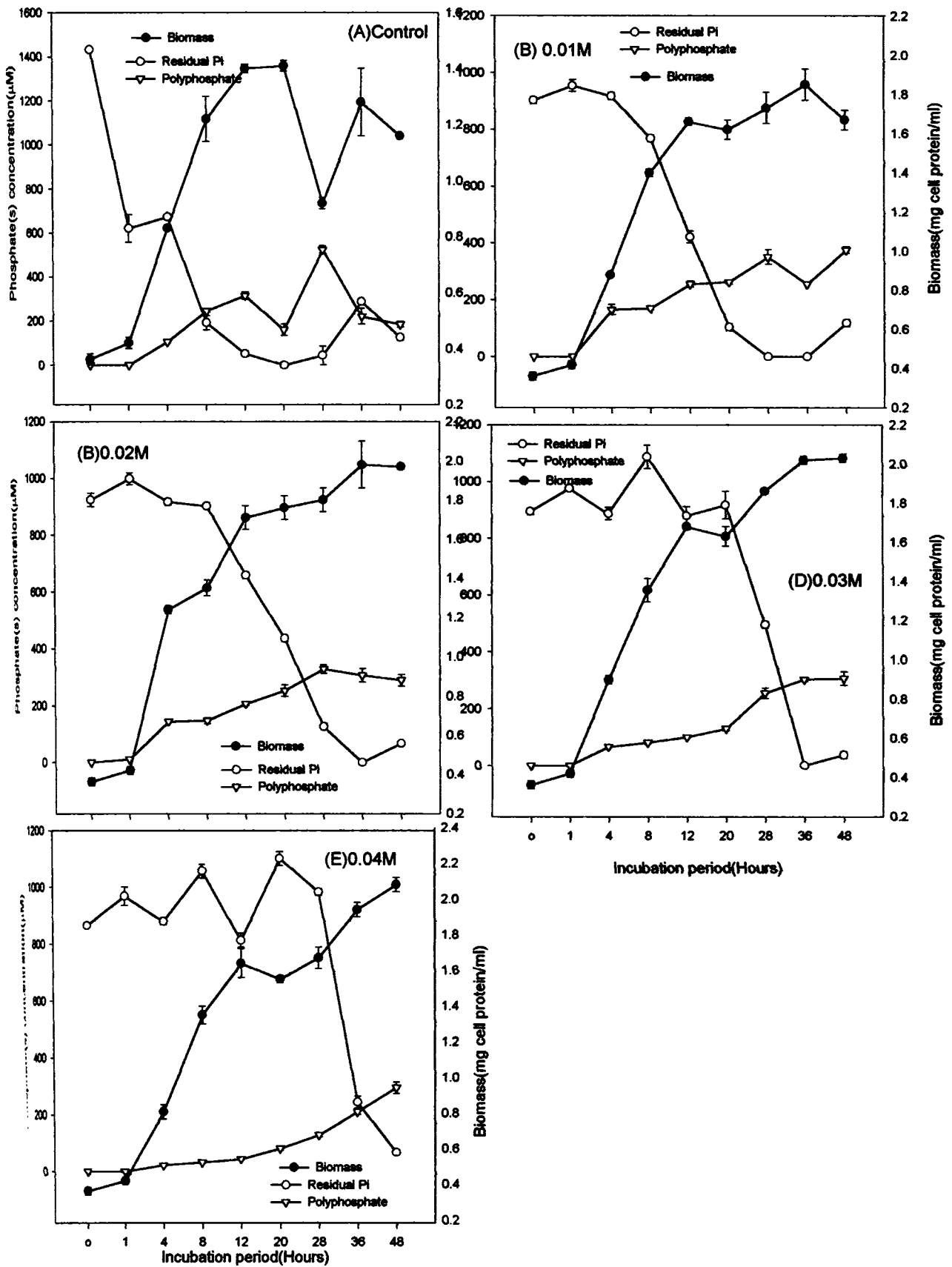

Fig.48 Effect of sodium citrate on biomass, Pi uptake and polyphosphate (polyP) accumulation by *Vibrio* sp BTDW-128 during growth in Zobell's marine broth(ZMB)



marginal Pi release in the presence of sodium citrate. Further, this kind of contrasting observation was made in the presence of sodium citrate, compared to the control, also during 1-4 and 4-8 hrs, except with 0.01M sodium citrate conc. which showed Pi uptake during 4-8 hr like that of control. However, later during 8-20 hrs a similar pattern of Pi uptake was recorded irrespective of the conc. of sodium citrate tested. In general, higher the conc. of sodium citrate lesser the rate of Pi uptake. Pi uptake was recorded only during stationary phase in the presence of higher conc. of sodium citrate above 0.02M. Nevertheless, almost similar levels of residual Pi was recorded for all the conc. of sodium citrate tested.

Data presented in Fig.47 evidence that presence of increasing conc. of sodium citrate led to reduction in the rate of polyP accumulation compared to control during 1-28 hrs, except during 12-20 hrs when the polyP levels declined in the cells grown in control medium. In general, polyP, in the presence of sodium citrate, recorded a gradual increase along with increase in incubation period during 4-28 hrs, after an initial rapid increase during 1-4 hrs. Almost a uniform trend was recorded for all the conc. of sodium citrate tested.

It was inferred from the results presented in Fig.48 that presence of sodium citrate enhanced the biomass of *Vibrio* sp compared to control, and the increase in biomass was also associated with Pi uptake and increase in polyP during growth. However, there was Pi release along with increase in biomass and polyP at conc. of 0.03M and 0.04M during 4-8 hrs. At 0.04M conc. during 12-20 hrs, Pi release was recorded along with decrease in biomass and increase in polyP. In general, sodium citrate, at higher conc. had independent effect on the rate of Pi uptake and release by cells compared to that in the control medium.

***Achromobacter* sp**

Very much similar to that observed with *Vibrio* sp, presence of sodium citrate in the medium affected the Pi uptake phenomenon of *Achromobacter* sp during growth (Fig.49). In general Pi uptake was drastically reduced when compared to that of control. While the residual Pi concentration rapidly declined during 0-1 hr, followed by further decline during 1-4 hrs in the control medium indicating Pi uptake, the residual Pi increased significantly in the presence of sodium citrate during 0-4 hrs. However, the residual Pi in the presence of sodium citrate declined rapidly during 4-8 hrs indicating Pi uptake, while no such decline was observed with the control during 4-8 hrs. Further, there was Pi release once again during 12-20 hrs, and the rate increased along with increase in concentration of sodium citrate unlike that of the control. Nevertheless, irrespective of

Fig.49 Effect of sodium citrate on phosphate(Pi) uptake by *Achromobacter* sp BTDS-64, during growth in Zobell's marine broth(ZMB)

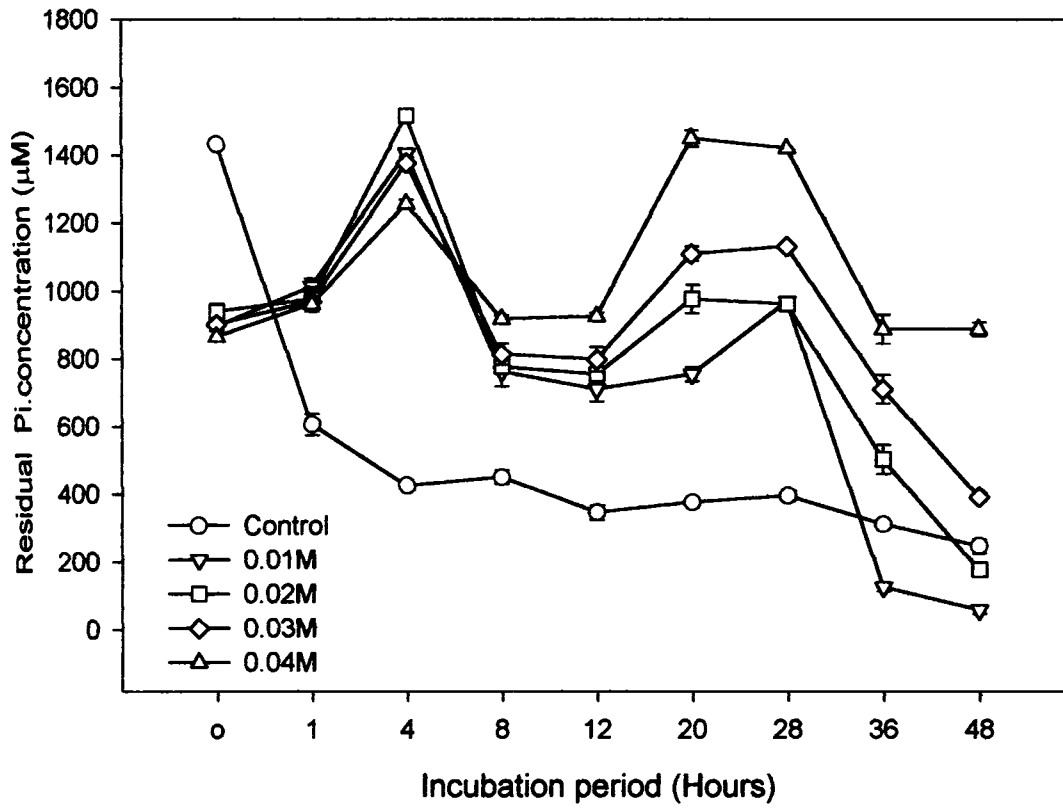

Fig.50 Effect of sodium citrate on polyphosphate(polyP) accumulation by *Achromobacter* sp BTDS 64 during growth in Zobell's marine broth (ZMB)

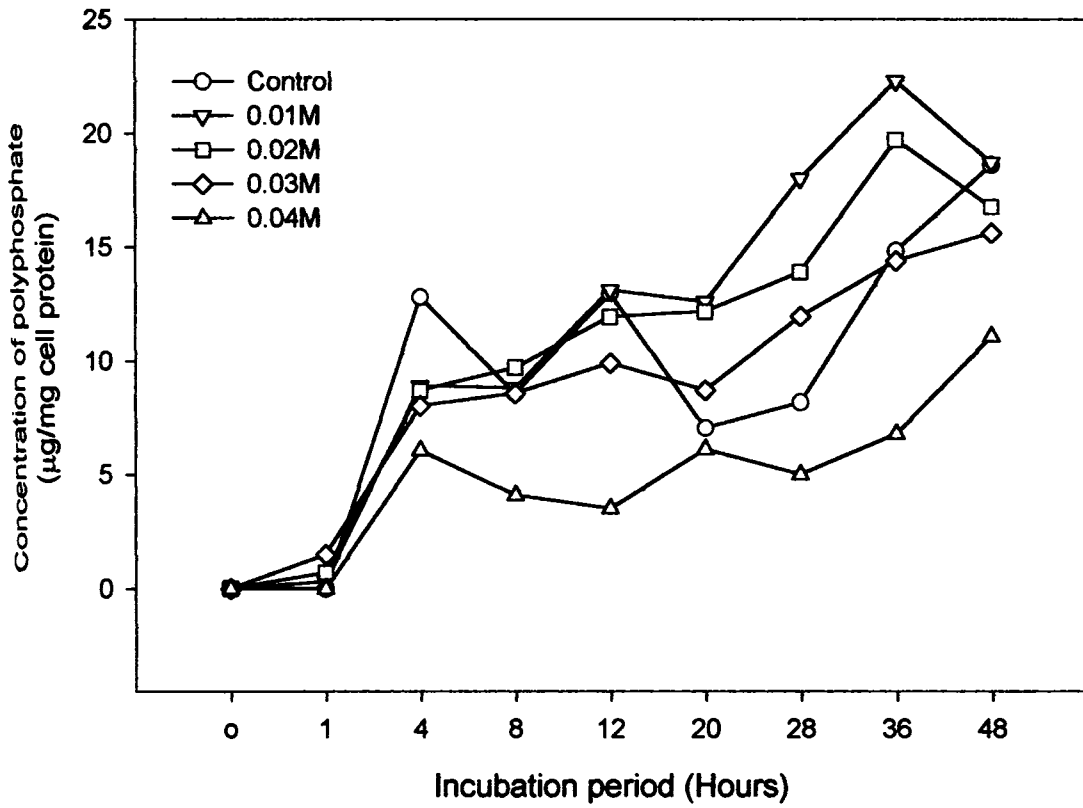
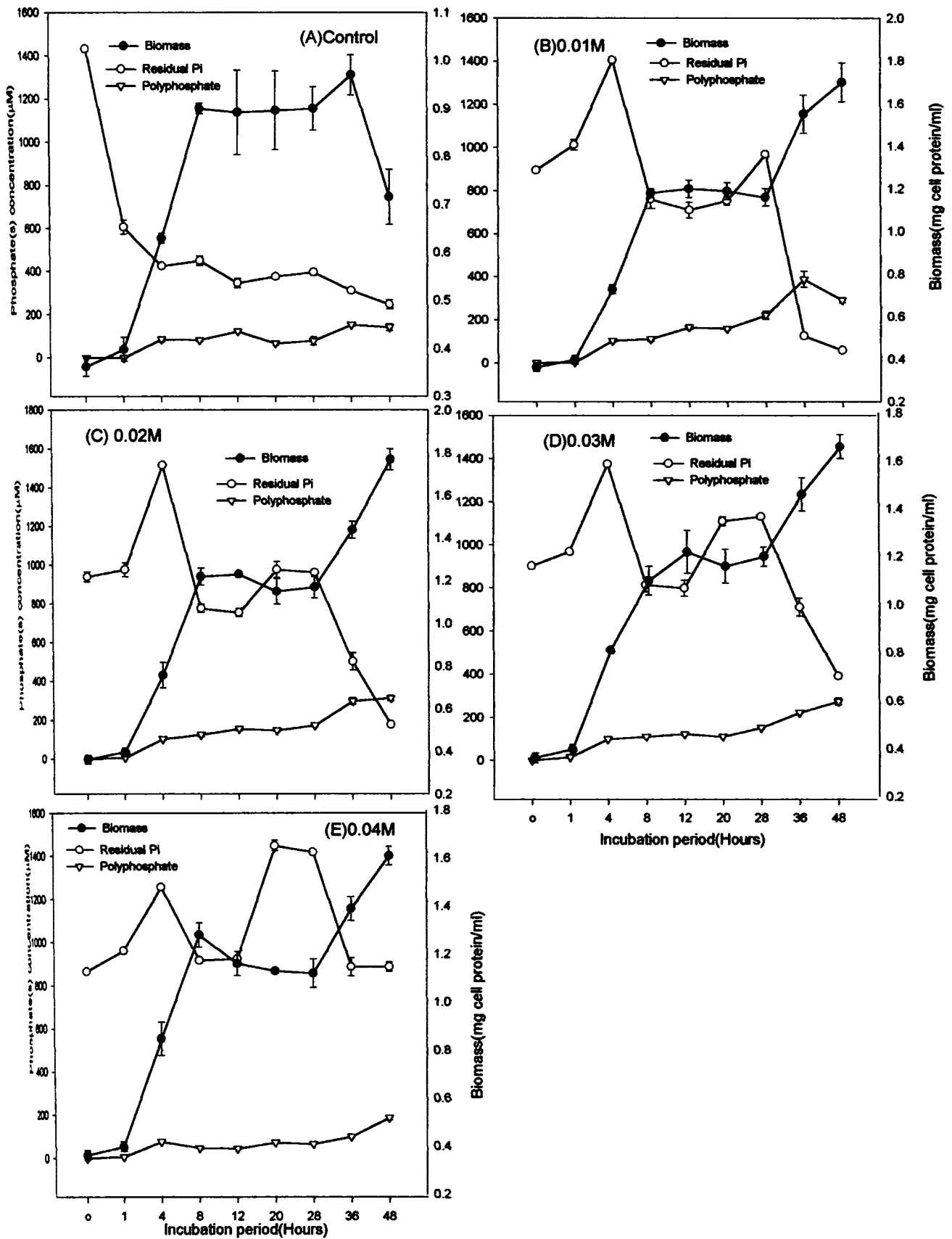

Fig.51 Effect of sodium citrate on biomass, Pi uptake and polyphosphate (polyP) accumulation by *Achromobacter* sp BTDS-64 during growth in Zobell's marine broth(ZMB)



the conc. of sodium citrate Pi uptake was recorded during 28-48 hrs. In fact at 0.01M sodium citrate conc. there was rapid Pi uptake, higher than the control, during 28-48 hrs.

Data presented in Fig.50 testify the impact of sodium citrate on polyP accumulation by *Achromobacter* sp during 1-8 hrs. While the rate of polyP accumulation rapidly increased during 1-4 hrs in the control medium, it was significantly reduced in the presence of sodium citrate. It was also observed that while a steep decline in polyP accumulation was recorded in the control medium during 4-8 hrs, there was marginal increase in polyP in the presence of sodium citrate, except at 0.04M conc. where a marginal decline in polyP was noted. Further, it was observed that during 20-36 hrs there was enhanced levels of polyP accumulation in the presence of sodium citrate except at 0.04M conc. compared to that recorded with the control. The rate of polyP accumulation was higher with the lowest conc. (0.01M) and decreased along with increase in conc. of sodium citrate.

From the results depicted in Fig.51, it is seen that presence of sodium citrate enhanced biomass accumulation by *Achromobacter* sp. Nevertheless, increase in polyP was associated with increase in biomass irrespective of the conc. of sodium citrate tested. Maximal polyP was recorded at 0.01M sodium citrate. While in the control medium, increase in biomass was associated with rapid Pi uptake during 0-4 hrs, increase in biomass was associated with rapid Pi release at all conc. of sodium citrate. Whereas, during 4-8 hrs Pi uptake was observed to be associated with biomass increase. Increase in polyP was recorded along with Pi uptake during 1-4 hrs in the control and during 28-36 hrs in the presence of sodium citrate at all conc. tested.

3.7.5 Ammonium Nitrate

Results obtained for the studies conducted on the impact of Ammonium Nitrate on phosphate uptake and polyP accumulation by marine bacteria are presented in Figs. 52-57.

Vibrio sp

From the results presented in Fig.52 it is inferred that on addition of ammonium nitrate to the control medium, the initial conc. of free Pi in the medium got reduced at zero hour. Further it was evident that in the presence of ammonium nitrate, the residual Pi increased indicating release during 0-1 hr while there was rapid decline in the conc. of free Pi in the control medium indicating Pi uptake. However, in the subsequent 1-4 hrs, unlike that in the control and at 0.03M ammonium nitrate where there was marginal Pi release, at all other conc. of ammonium nitrate there was Pi uptake. Further, irrespective of the initial ammonium nitrate conc. there was rapid Pi uptake during 4-8 hrs. During the later hours of incubation the rate of Pi uptake was very much dependent upon

Fig.52 Effect of ammonium nitrate on phosphate(Pi) uptake by *Vibrio* sp BTDW-128, during growth in Zobell's marine broth(ZMB)

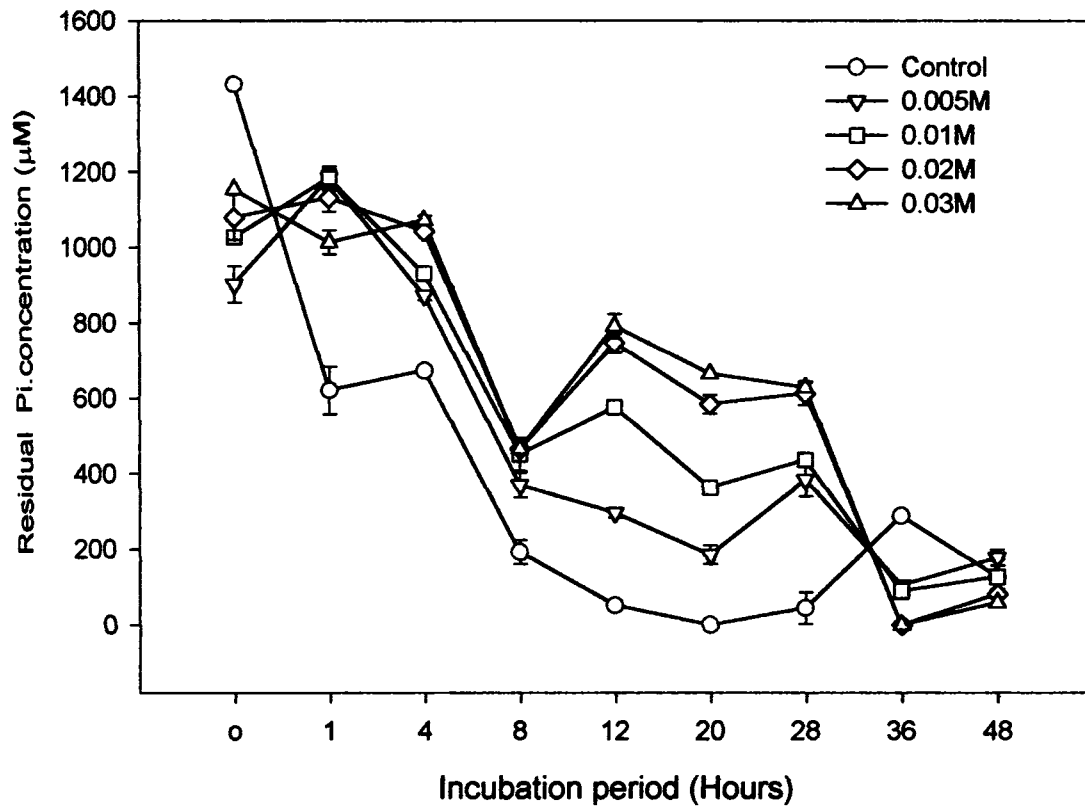
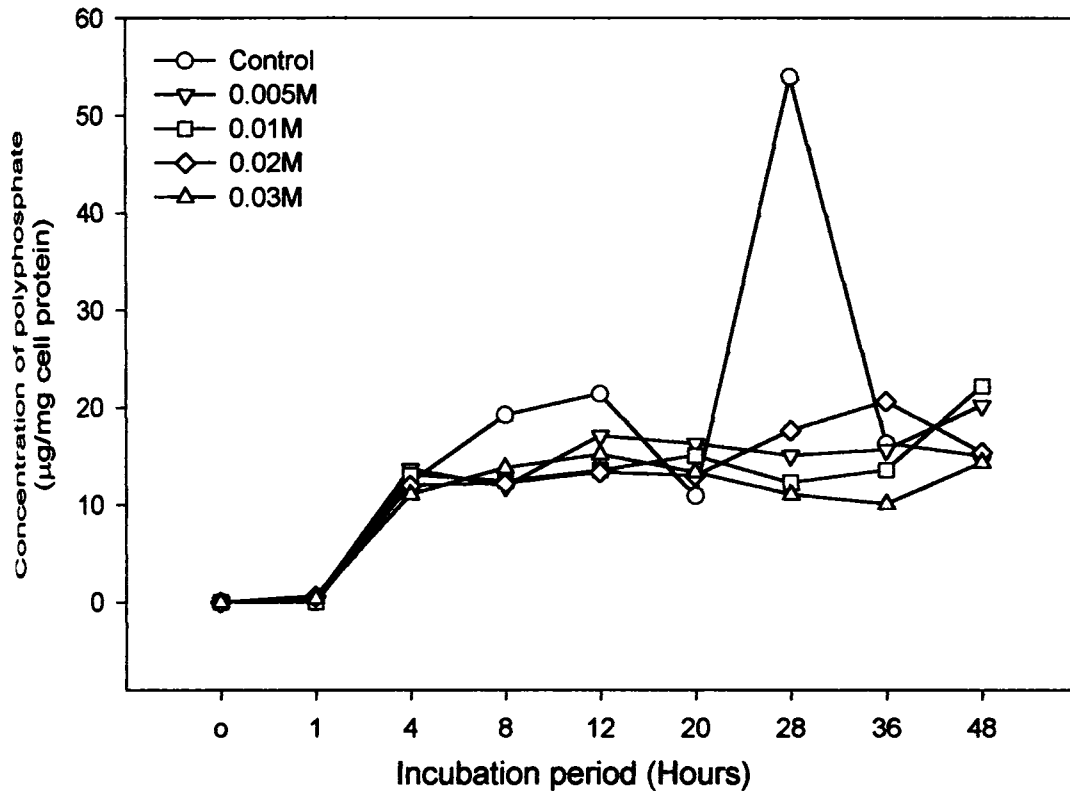
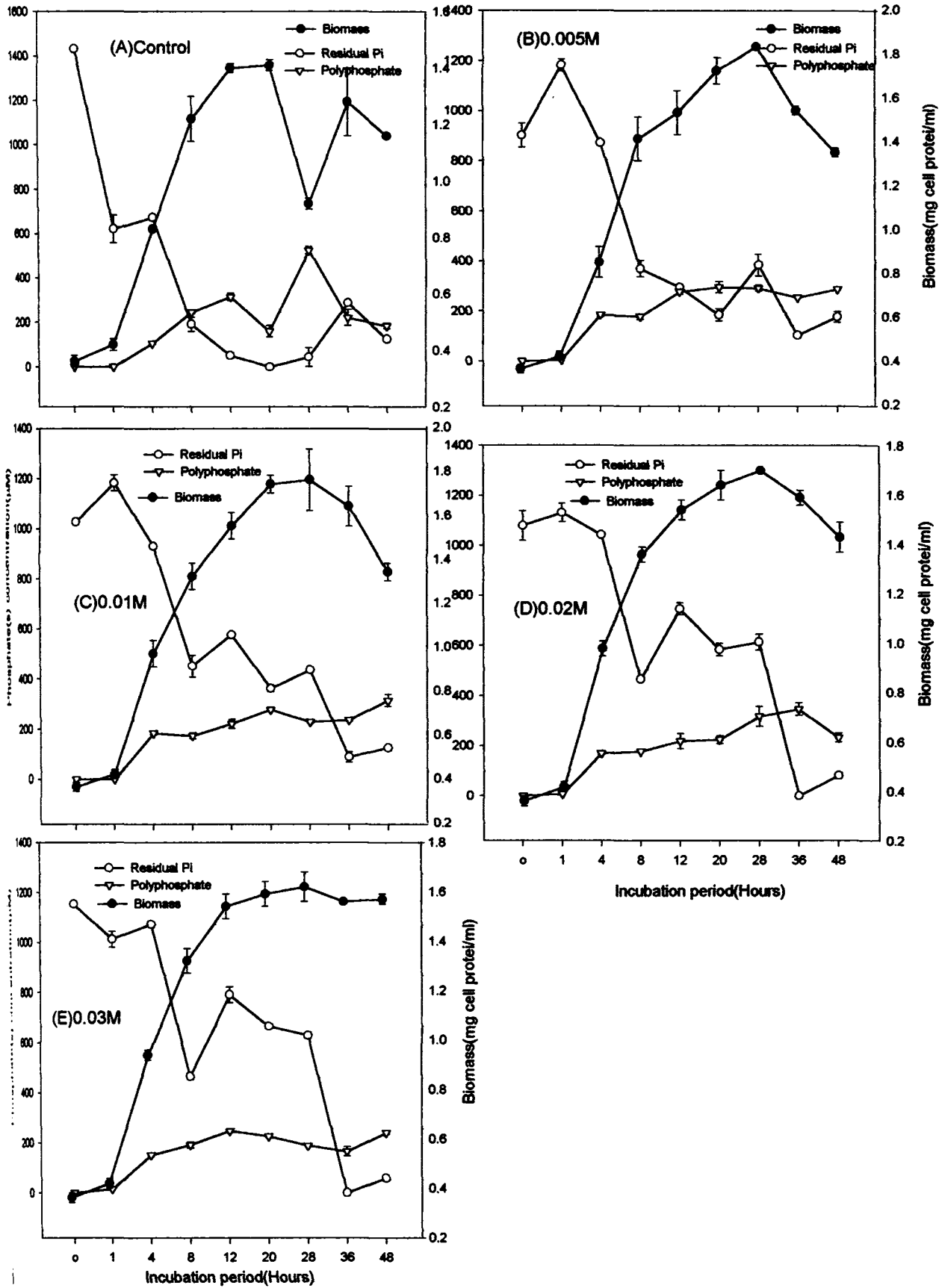

Fig.53 Effect of ammonium nitrate on polyphosphate (polyP) accumulation by *Vibrio* sp BTDW-128 during growth in Zobell's marine broth (ZMB)



4 Effect of ammonium nitrate on biomass, Pi uptake and polyphosphate (polyP) accumulation by *Vibrio* sp. BTDW-128 during growth in Zobell's marine broth (ZMB)



the conc. of ammonium nitrate in the medium. Thus, the rate of Pi uptake was at reduced levels when compared to control medium and at higher conc. of ammonium nitrate there was increase in Pi release than Pi uptake. Interestingly, during 28-36 hrs and 36-48 hrs contrasting pattern of Pi uptake and release was recorded for the control and in the presence of ammonium nitrate in the medium. Thus, while there was Pi release in the control there was Pi uptake in the presence of ammonium nitrate and vice versa.

Rate of polyP accumulation by *Vibrio* sp was drastically affected by the presence of excess conc. of ammonium nitrate and in general there was reduction in the levels of polyP compared to control medium during the period 1-28 hrs (Fig.53). There was not much variation in response for the different conc. of ammonium nitrate tested.

In the presence of ammonium nitrate in the medium, there was increase in the biomass accumulation by *Vibrio* sp when compared to that in the control medium (Fig.54). Nevertheless, increase in biomass was associated with increase in Pi uptake irrespective of the ammonium nitrate concentration in the medium during 1-8 hrs, except at 0.03M and in the control during 1-4 hr. Further, at higher concentration of 0.01M-0.03M ammonium nitrate, Pi release associated with increase in biomass was also recorded during 8-12 hrs. Increase in polyP accumulation was recorded along with Pi uptake during 1-4 hrs at all concentration of ammonium nitrate, except at 0.03M concentration when it was associated with Pi release. During later hours, Pi uptake and polyP accumulation were associated. PolyP accumulation was directly associated with increase in biomass irrespective of the initial conc. of ammonium nitrate.

***Achromobacter* sp**

In the presence of ammonium nitrate in the medium, initial concentration of free Pi was reduced when compared to control medium and also the rate of Pi uptake was significantly affected (Fig.55). Instead of Pi uptake, there was Pi release in the presence of ammonium nitrate during 0-1 hr. However, except at higher conc. of 0.03M, at all other conc. there was Pi uptake during the subsequent 1-4 hrs. Nevertheless, there was rapid Pi uptake at all the conc. of ammonium nitrate during 4-8 hrs followed by a rapid release of Pi during 8-12 hrs. Whereas, in the case of 0.005M ammonium nitrate, increase in Pi uptake continued significantly during 1-12 hrs, followed by a rapid Pi release during 12-20 hrs unlike that observed with other instances. Pi release in the presence of ammonium nitrate was further recorded during 36-48 hrs when compared to control.

Fig.55 Effect of ammonium nitrate on phosphate(Pi) uptake by *Achromobacter* sp BTDS-64, during growth in Zobell's marine broth(ZMB)

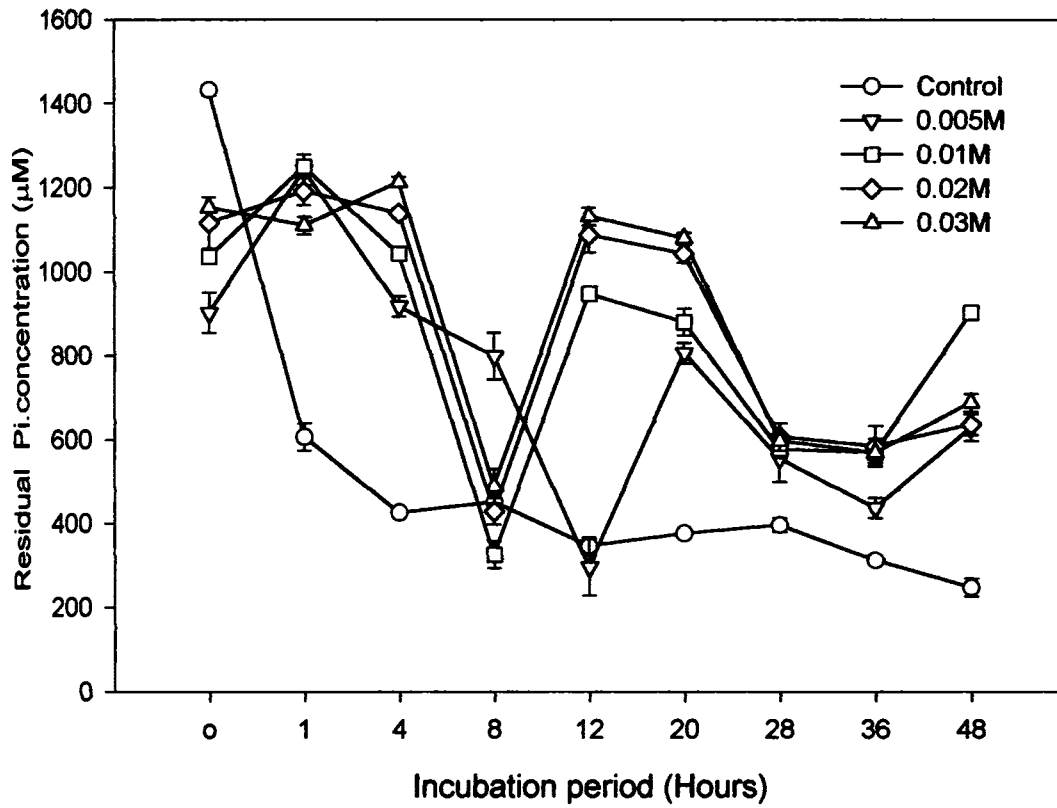
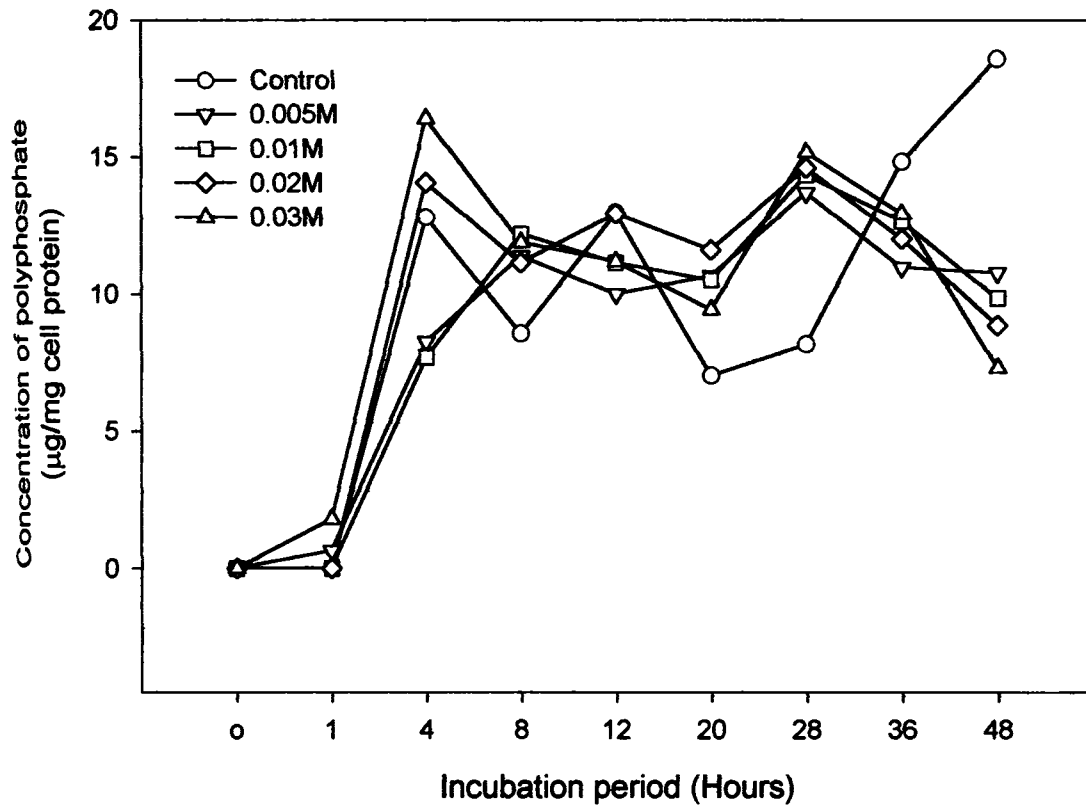
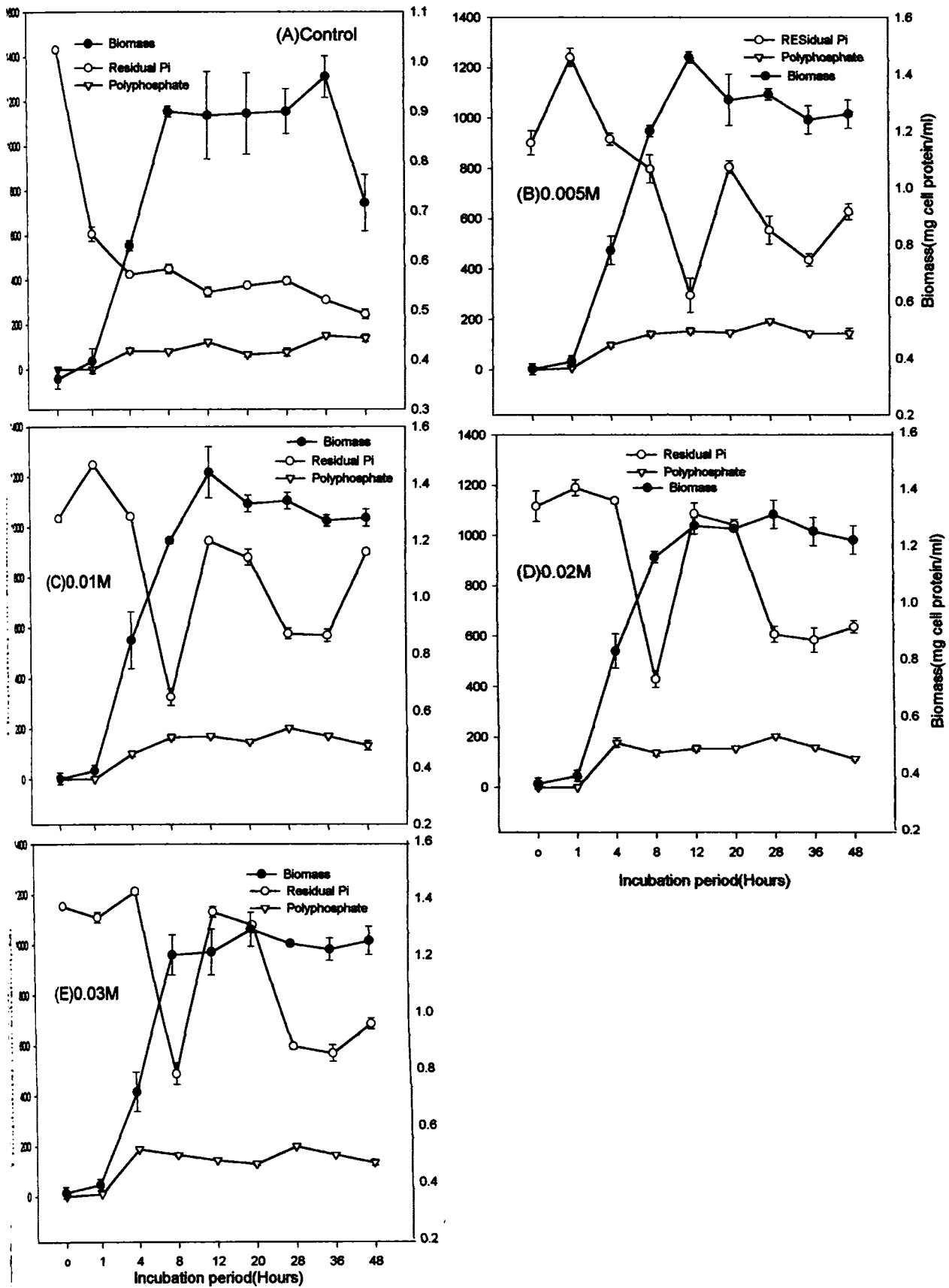

Fig.56 Effect of ammonium nitrate on polyphosphate(polyP) accumulation by *Achromobacter* sp BTDS-64 during growth in Zobell's marine broth (ZMB)



Effect of ammonium nitrate on biomass, Pi uptake and polyphosphate (polyP) accumulation by *Achromobacter* sp BTDS-64 during growth in Zobell's marine broth(ZMB)



Data presented in Fig.56 indicated evidently the positive effect of presence of ammonium nitrate on enhancement of the rate of polyP accumulation by the cells higher than the control, throughout the period of study. Decline in the rate of polyP accumulation was recorded, however, during 4-8 hrs at 0.02M; 4-20 hrs at 0.003M and during 28-48 hrs at all the conc. of ammonium nitrate tested. Nevertheless, a second hike in the rate of polyP accumulation was observed, irrespective of the conc. of ammonium nitrate during 20-28 hrs unlike that in the control where increase in polyP was recorded during 20-36 hrs. In general, polyP accumulation in the control was lesser than that observed in the presence of ammonium nitrate.

From the results presented in Fig.57, it is seen that in the presence of ammonium nitrate, there was increase in biomass of *Achromobacter* sp. Nevertheless, increase in biomass was associated with rapid Pi uptake and increase in polyP during 1-4 hrs except at 0.03M, when there was Pi release. Further, during 4-8 hrs of active growth it was observed that increase in biomass was coupled with increase in Pi uptake but with reduction in polyP accumulation in the presence of ammonium nitrate. It was also recorded that rapid Pi release was associated with increase in biomass during 8-12 hrs, in the presence of ammonium nitrate. However, there was no marked variation, during the later hours of incubation, for all the variables studied.

3.8 Other Additional Organic Carbon Sources

3.8.1 Peptone

Effect of additional peptone in the medium, as additional carbon source, on the rate of Pi uptake and polyP accumulation by marine bacteria was studied and the results are presented in Fig.58-63.

***Vibrio* sp**

Data presented in the Fig. 58 indicated that there was rapid uptake of Pi during 0-1 hr and 4-8 hrs in the control medium while there was no Pi uptake during 1-12 hrs in the presence of additional peptone. However, rapid Pi uptake, in the presence of added peptone was recorded during 12-36 hrs.

There was significant impact of additional peptone on polyP accumulation by *Vibrio* sp during 1-12 hrs irrespective of the conc. of added peptone compared to that in the control (Fig.59). However, there was rapid and maximal level of polyP accumulation during 12-20 hrs. Rapid decline in polyP was also recorded during 20-28 hrs at 4% peptone and during 28-36 hrs at 3%

Fig.58 Effect of peptone on phosphate(Pi) uptake by *Vibrio* sp BTDW-128, during growth in Zobell's marine broth(ZMB)

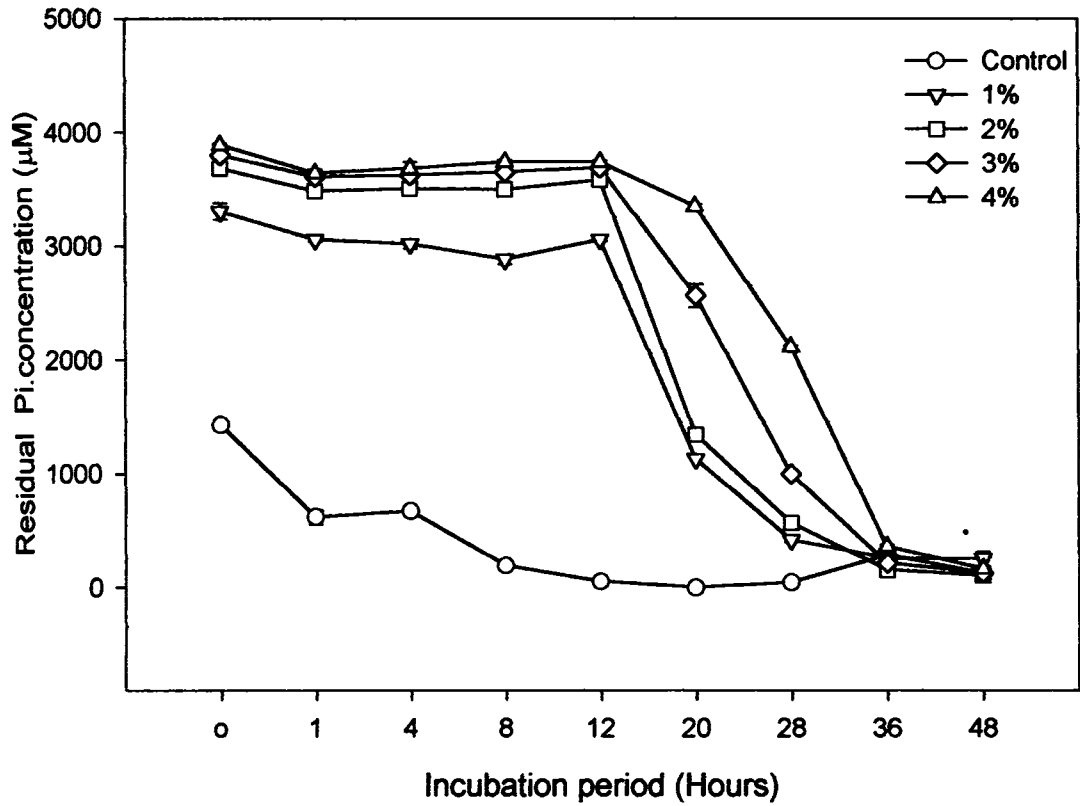
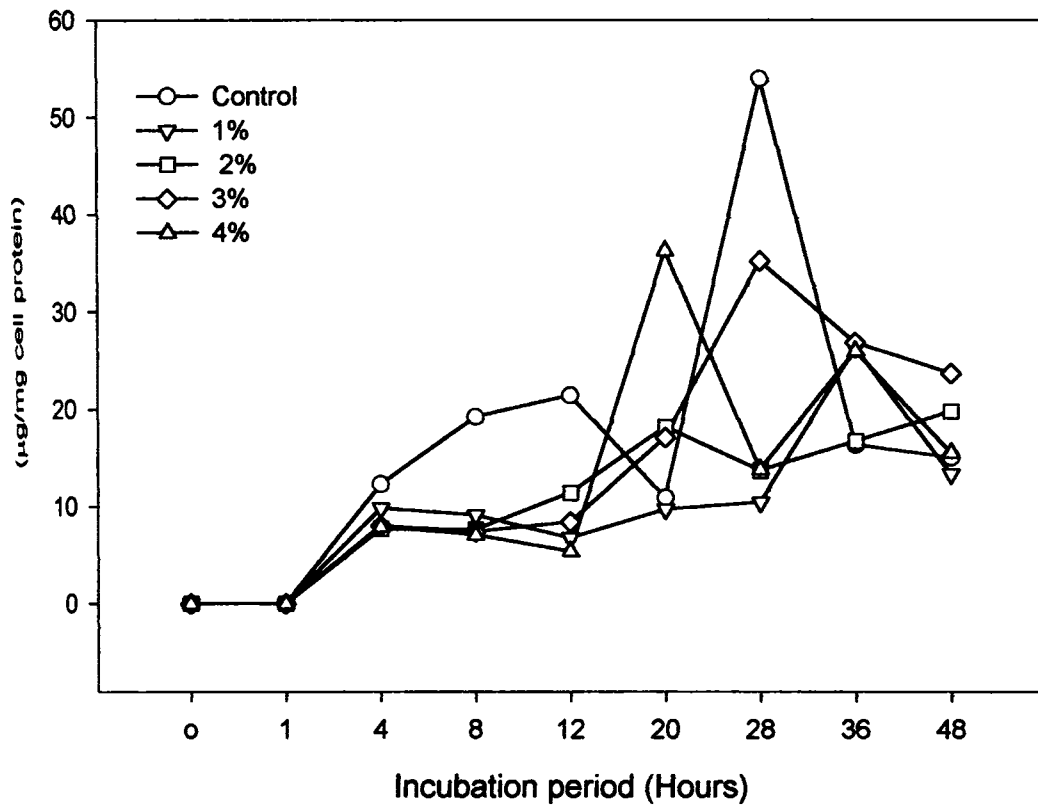
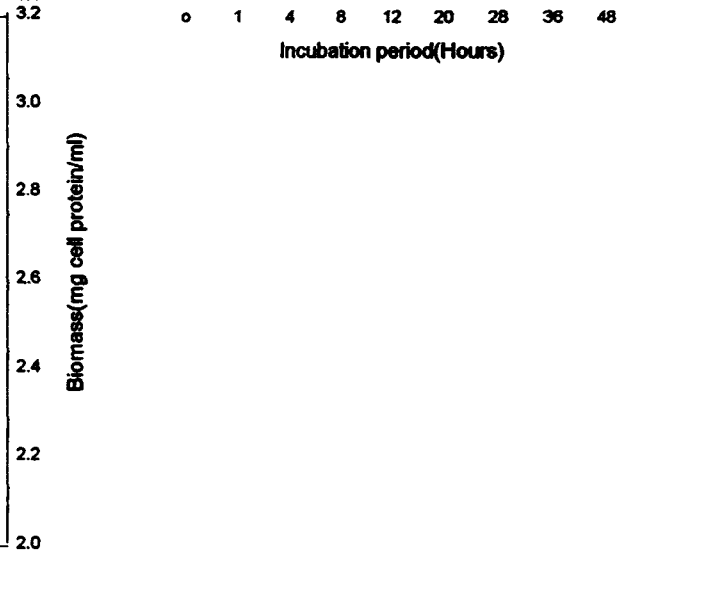
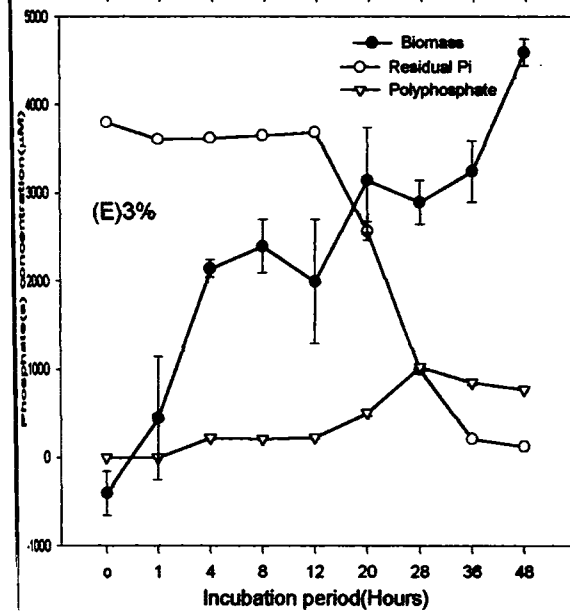
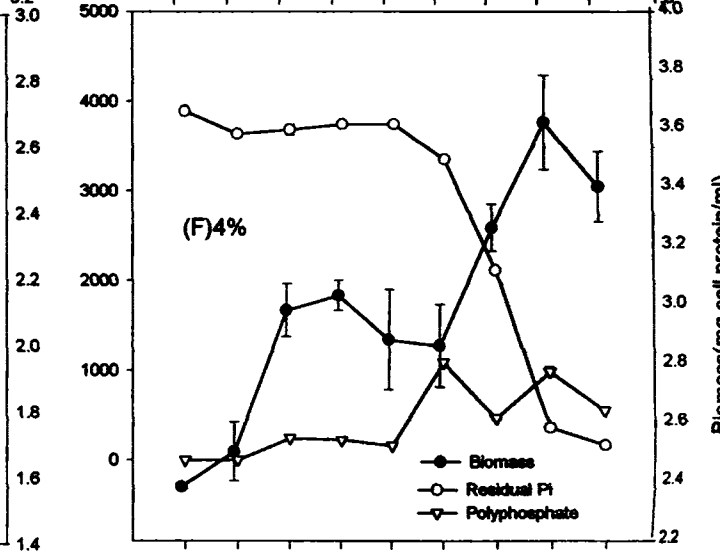
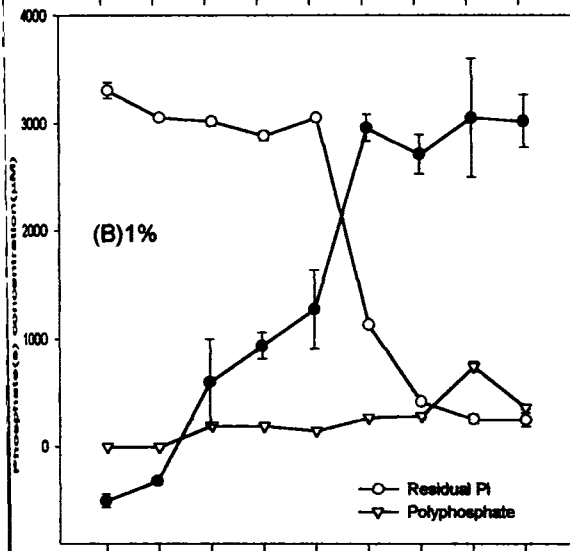
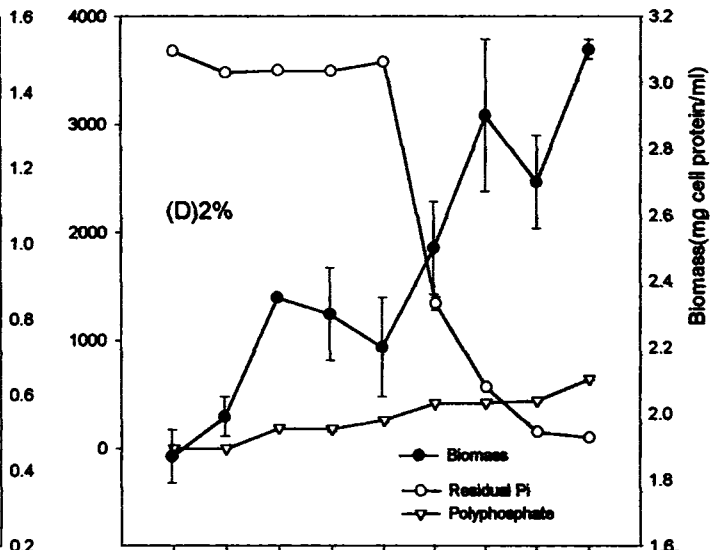
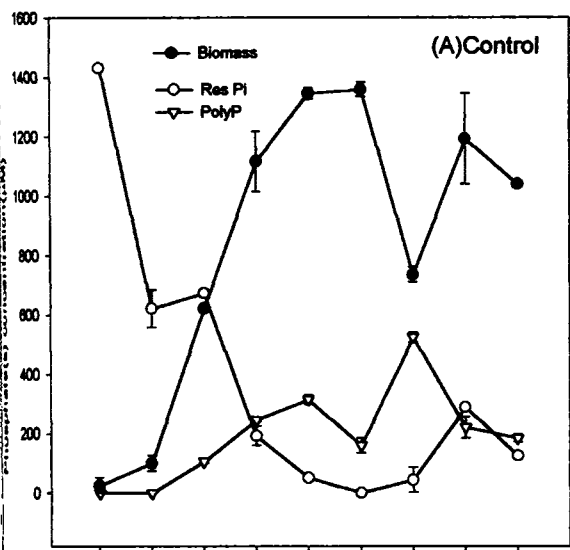

Fig.59 Effect of peptone on polyphosphate(polyP) accumulation by *Vibrio* sp BTDW-128 during growth in Zobell's marine broth (ZMB)



60 Effect of peptone on biomass, Pi uptake and polyphosphate (polyP) accumulation by *Vibrio* sp BTDW-128 during growth in Zobell's marine broth(ZMB)



peptone conc. Except at 2% conc., at all other instances polyP declined during 36-48 hrs. In fact maximal polyP was recorded in the presence of higher conc. of peptone compared to control.

Data presented in the Fig.60 indicated that irrespective of the additional concentration of peptone in the medium, and despite an increase in the biomass, there was neither Pi uptake nor release of Pi detectable during 0-12 hrs, when compared to the control. However, unlike that in the control where Pi uptake increased from 8 hrs onwards, in the presence of additional peptone conc., there was a high rate of Pi uptake indicated by rapid reduction in the residual Pi during 12-28 hrs. There was significant polyP increase during 12-28 hrs associated with Pi uptake and biomass increase.

Achromobacter

From the results presented in Fig. 61 it is evident that presence of additional conc. of peptone in the medium influenced the rate of Pi uptake by *Achromobacter* sp. At all the added conc. of peptone there was no effective uptake of Pi till 8 hrs. However, there was marginal Pi uptake, at all conc. of peptone tested, during 8-12 hrs. There was marked Pi uptake during 36-48 hrs at all conc. of peptone tested. In general, the rate of Pi uptake or release was decreased along with increase in initial peptone conc. in the medium.

Significant reduction in rapid polyP accumulation was noted during 1-12 hrs irrespective of the conc. of peptone added to the medium (Fig.62). After a marginal slag during 1-12 hrs, the rate of polyP increased gradually and steadily during the remaining period of incubation, irrespective of the conc. of peptone tested. Maximal polyP was recorded at 48 hrs at 4% of peptone conc. It was also observed that increase in maximal levels of polyP accumulation was observed along with increase in peptone conc. added to the medium. In general there was a uniform pattern for the various conc. of peptone tested.

Data presented in Fig. 63 indicated that the maximal biomass was recorded only after 36 hrs, when compared to that in the control, where there was rapid increase in biomass during early hours and the maximum was recorded at 8 hrs. Increase in the conc. of peptone also drastically influenced the growth curve pattern of *Achromobacter* sp as seen from the Fig.63. Except at 1% conc. of peptone, where there was a clear relationship of increase in biomass along with Pi uptake, at other conc. of peptone tested there was no definite relationship between the variables studied. Nevertheless, a positive relationship could be attributed to the three variables of Pi uptake, biomass

Fig.61 Effect of peptone on phosphate(Pi) uptake by *Achromobacter* sp BTDS-64, during growth in Zobell's marine broth(ZMB)

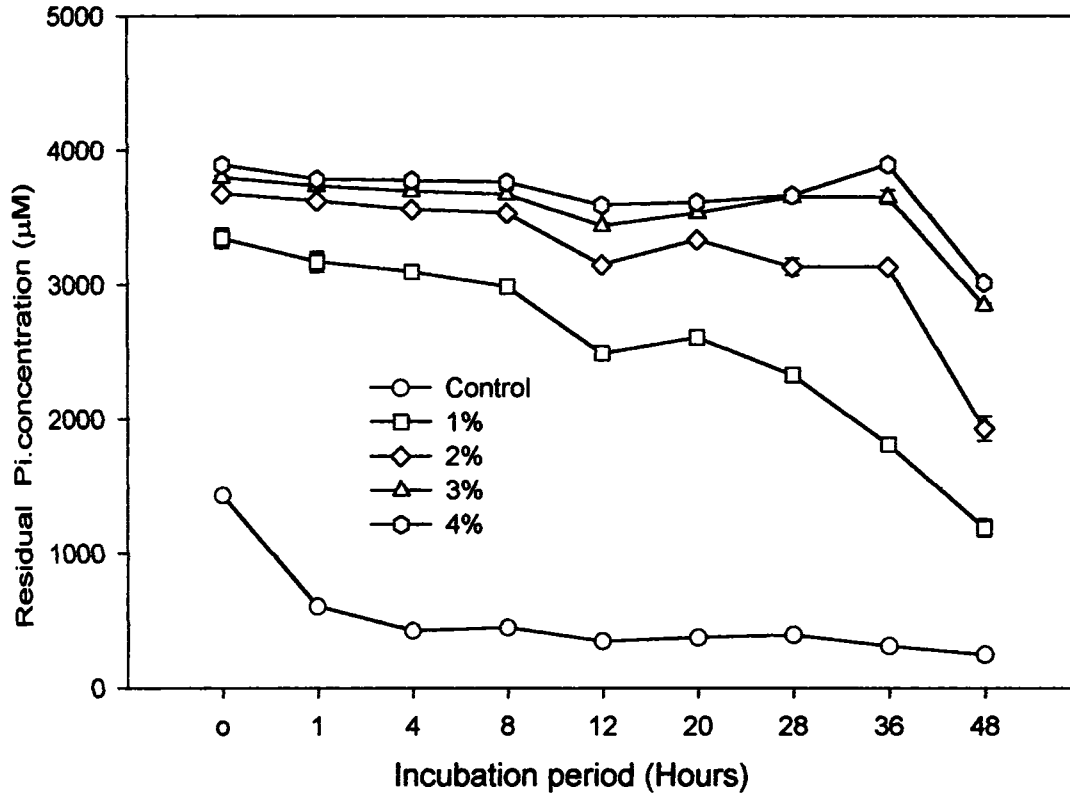

Fig.62 Effect of peptone on polyphosphate(polyP) accumulation by *Achromobacter* sp BTDS-64 during growth in Zobell's marine broth (ZMB)

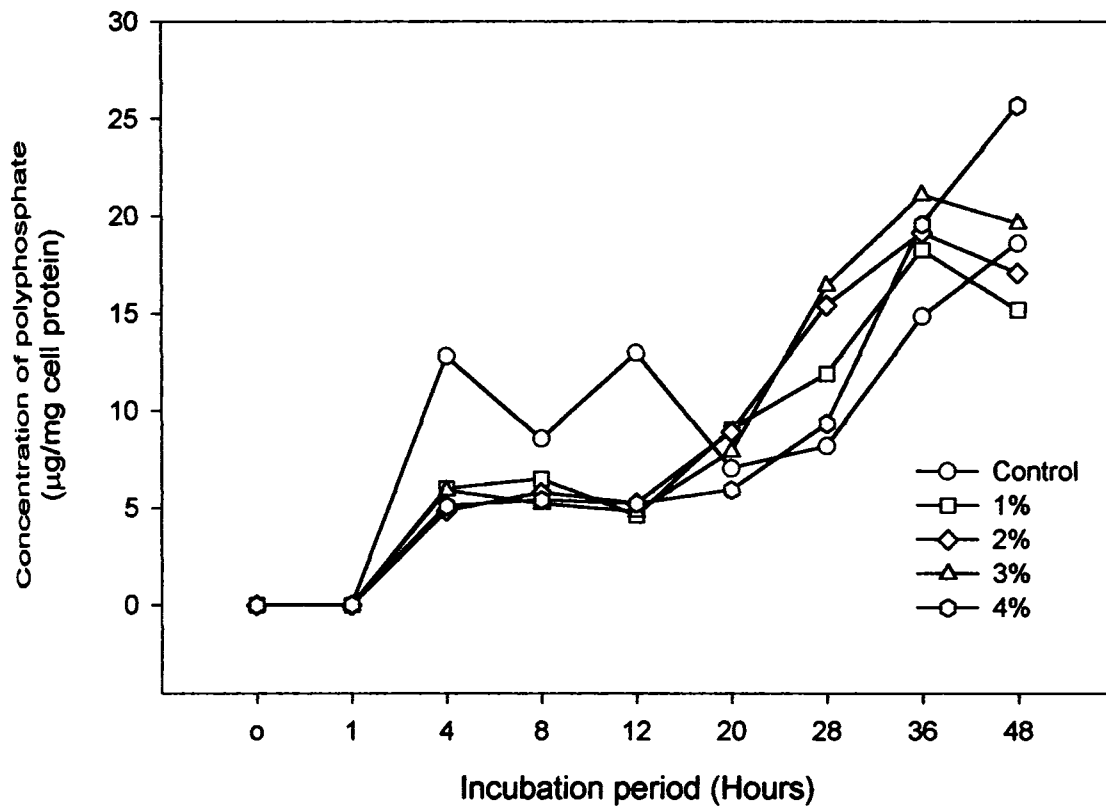
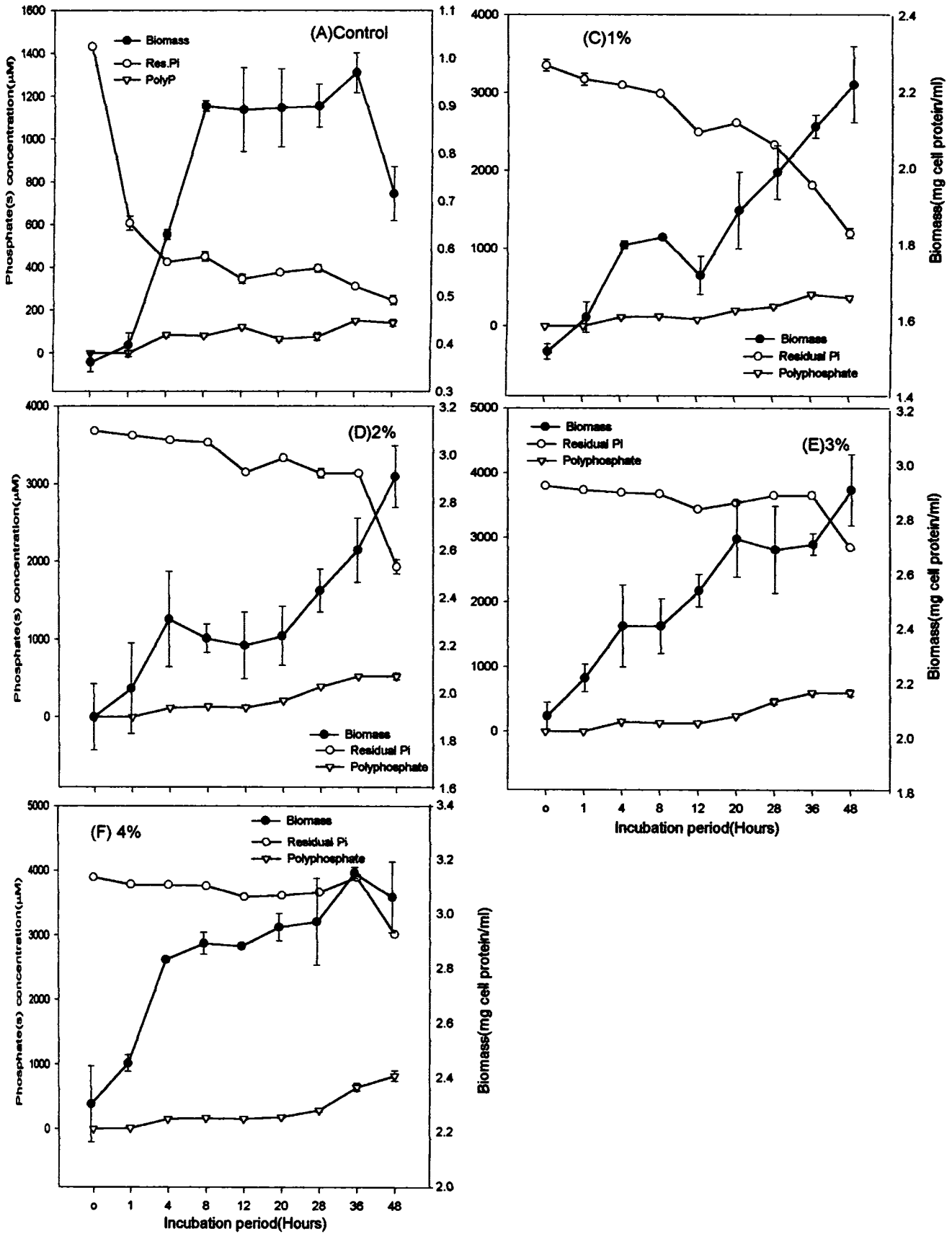

Fig.63 Effect of peptone on biomass, Pi uptake and polyphosphate (polyP) accumulation by *Achromobacter* sp BTDS-64 during growth in Zobell's marine broth(ZMB)



and polyP during 36-48 hrs, except at 4% peptone conc. where there was decline in biomass while Pi uptake and polyP accumulation were associated.

3.8.2 Yeast Extract

Effect of different conc. of yeast extract as additional source of carbon in the medium, on Pi uptake and polyP accumulation by marine bacteria was studied and the results are presented in Figs. 64-69.

Vibrio sp

Addition of yeast extract led to increase in the initial Pi concentration of the medium proportionately because of the phosphate present in the yeast extract. Excess conc. of yeast extract in the cultivation medium had a very clear impact on the Pi uptake pattern of *Vibrio sp* during 0-4 hrs (Fig.64). While there was a rapid decline in residual Pi conc. in the medium in the control during 0-1 hr, there was immediate release of Pi into the medium in the presence of excess conc. of yeast extract. Pi release into the medium, in the presence of yeast extract was recorded for all the conc. of yeast extract studied till 4 hrs. However, irrespective of the initial conc. of yeast extract, there was Pi uptake indicated by reduction in residual Pi, in the medium during 4-28 hrs. Increase in conc. of yeast extract added to the medium resulted in reduction in the rate of Pi uptake by the cells uniformly, when compared to control medium.

Results presented in Fig.65 suggested that varying conc. of yeast extract did not influence significantly the rate of polyP accumulation during the early hours of growth(0-8) hrs although there was increase in polyP accumulation. In fact, yeast extract, at conc. above 0.8%, supported rapid increase in the rate of polyP accumulation, higher than the control medium during 12-20 hrs and a maximal polyP was recorded with 0.8% yeast extract at 20 hrs followed by 0.4% and 1.6% yeast extract. However, the polyP levels declined rapidly during the subsequent period of incubation, 20-48 hrs, except at conc. of 1.6% and 0.4% when there was once again increase in polyP levels during 36-48 hrs.

At all the conc. of yeast extract added to the medium, the Pi uptake was affected and there was release of Pi into the medium along with increase in biomass and polyP during 0-4 hrs, unlike that of control (Fig.66). However, there was uptake of Pi along with increase in biomass during 8-20 hrs, irrespective of the conc. of yeast extract tested. Increase in biomass and polyP followed an identical trend during 0-20 hrs. PolyP levels declined during late incubation period except for a

Fig.64 Effect of yeast extract on phosphate(Pi) uptake by *Vibrio* sp BTDW-128, during growth in Zobell's marine broth(ZMB)

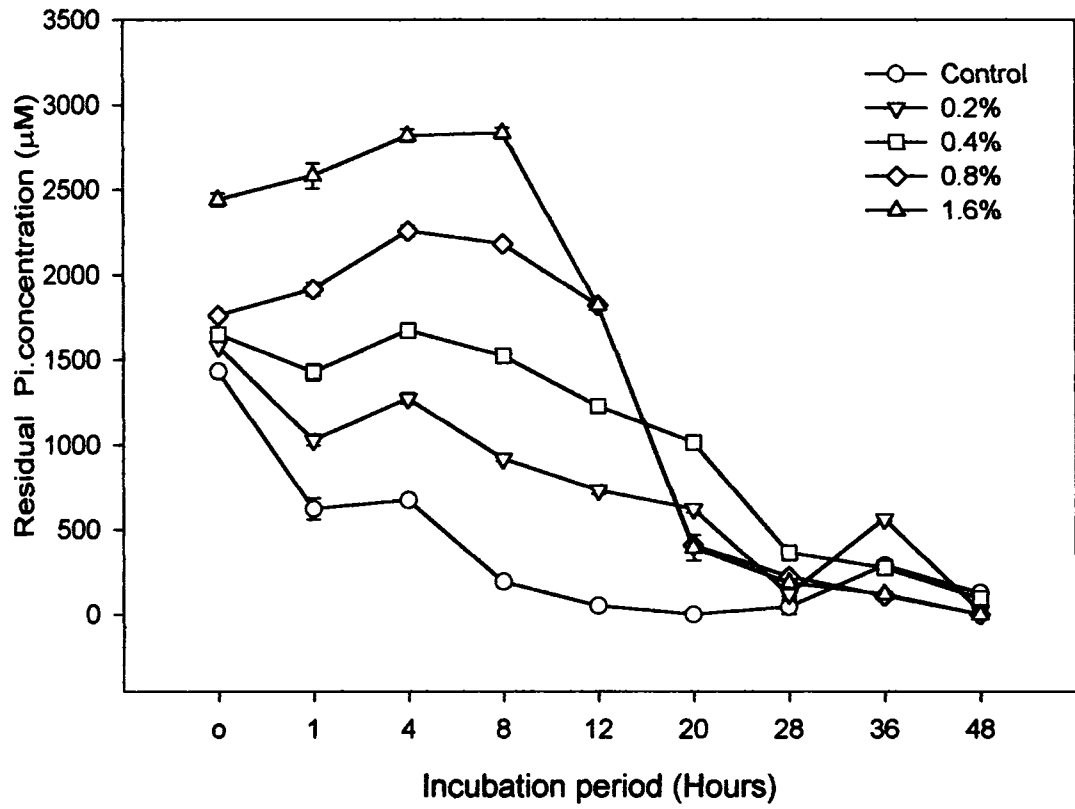
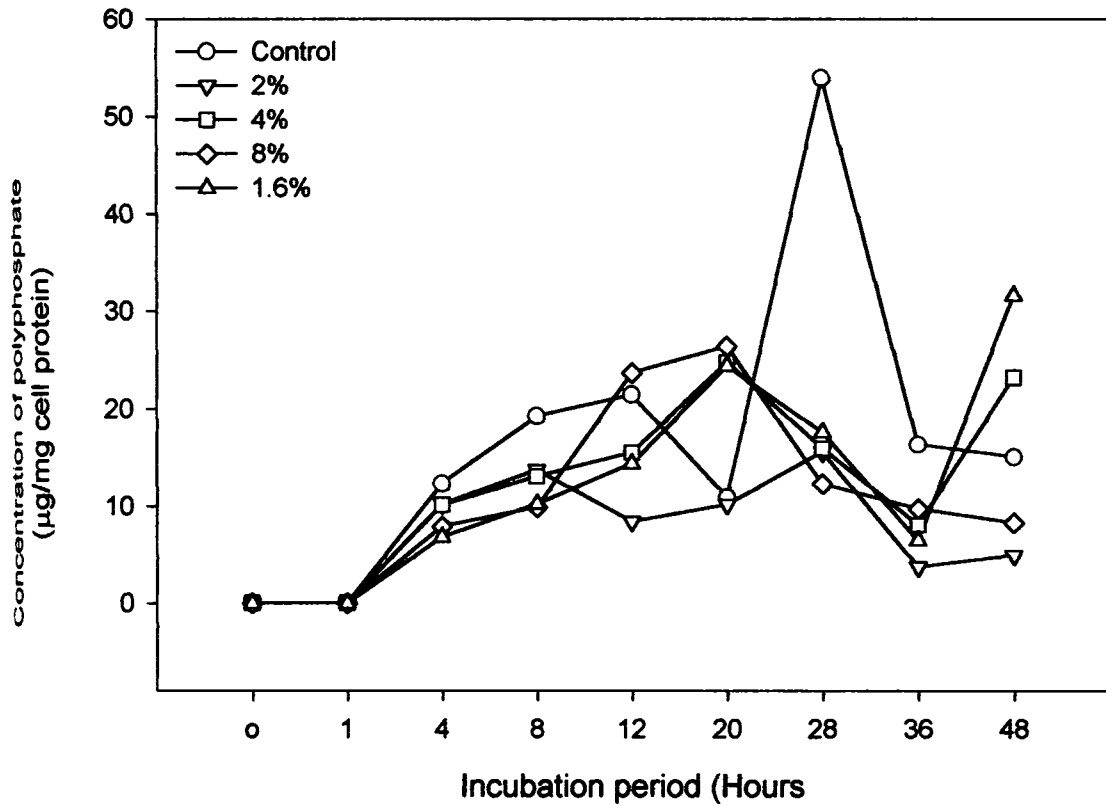

Fig.65 Effect of yeast extract on polyphosphate(polyP) accumulation by *Vibrio* sp BTDW-128 during growth in Zobell's marine broth (ZMB)



66 Effect of yeast extract on biomass, Pi uptake and polyphosphate (polyP) accumulation by *Vibrio* sp BTDW-128 during growth in Zobell's marine broth(ZMB)

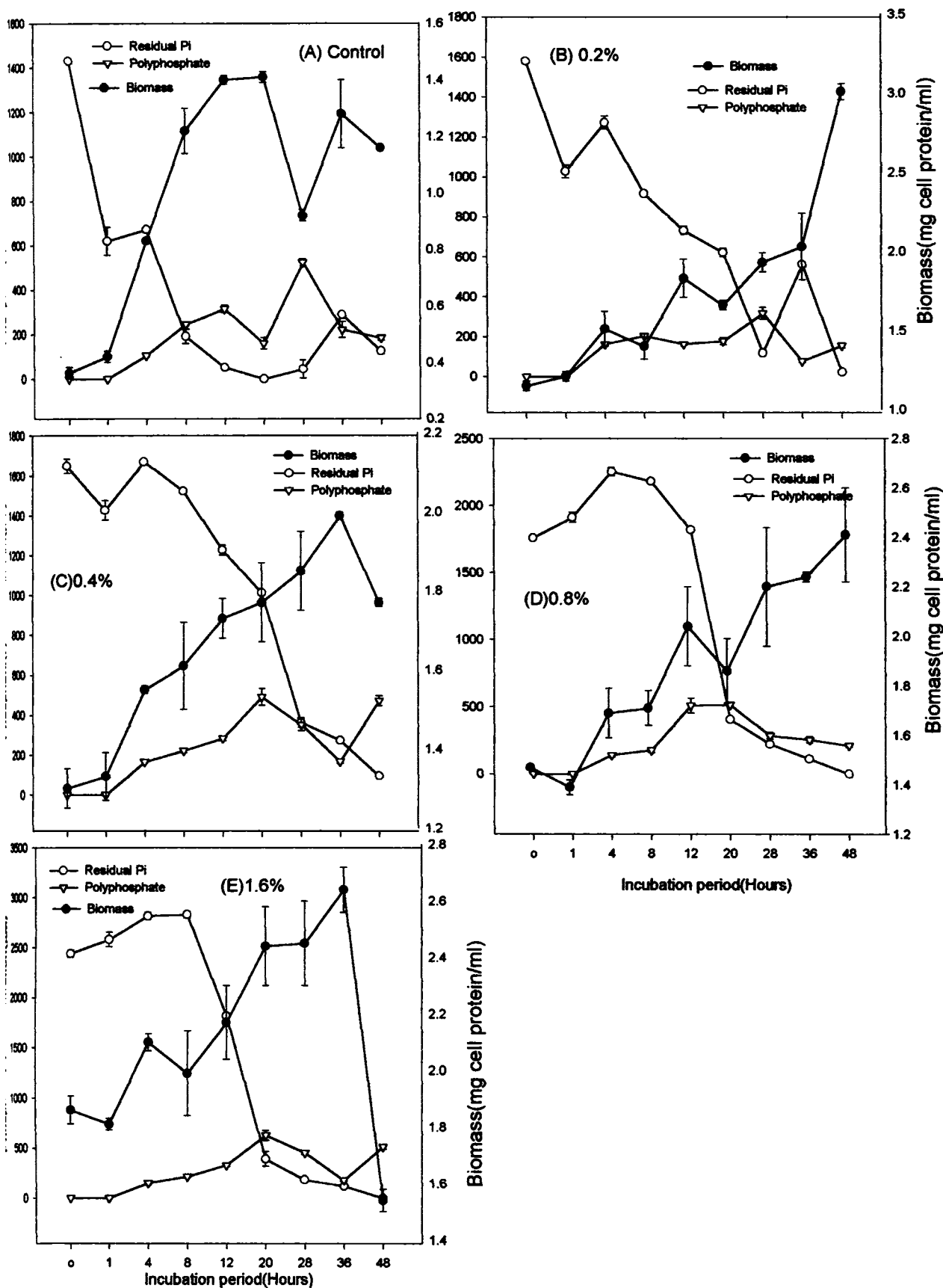

Fig.67 Effect of yeast extract on phosphate(Pi) uptake by *Achromobacter* sp BTDS-64, during growth in Zobell's marine broth(ZMB)

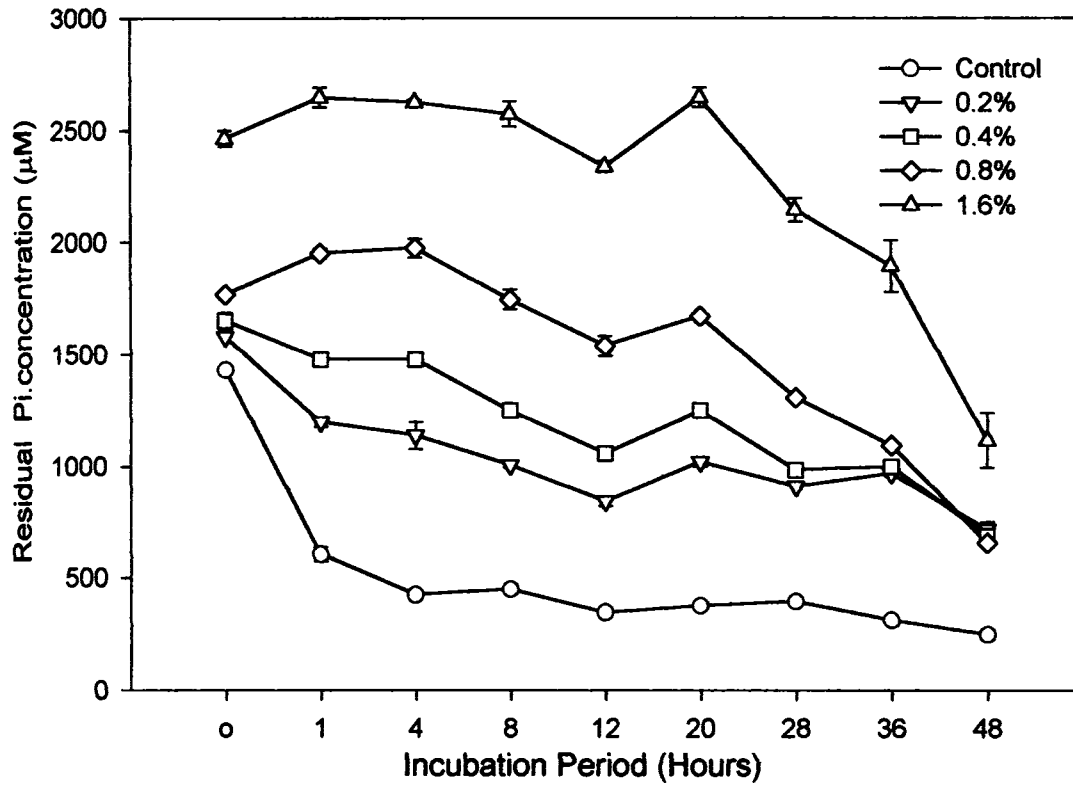
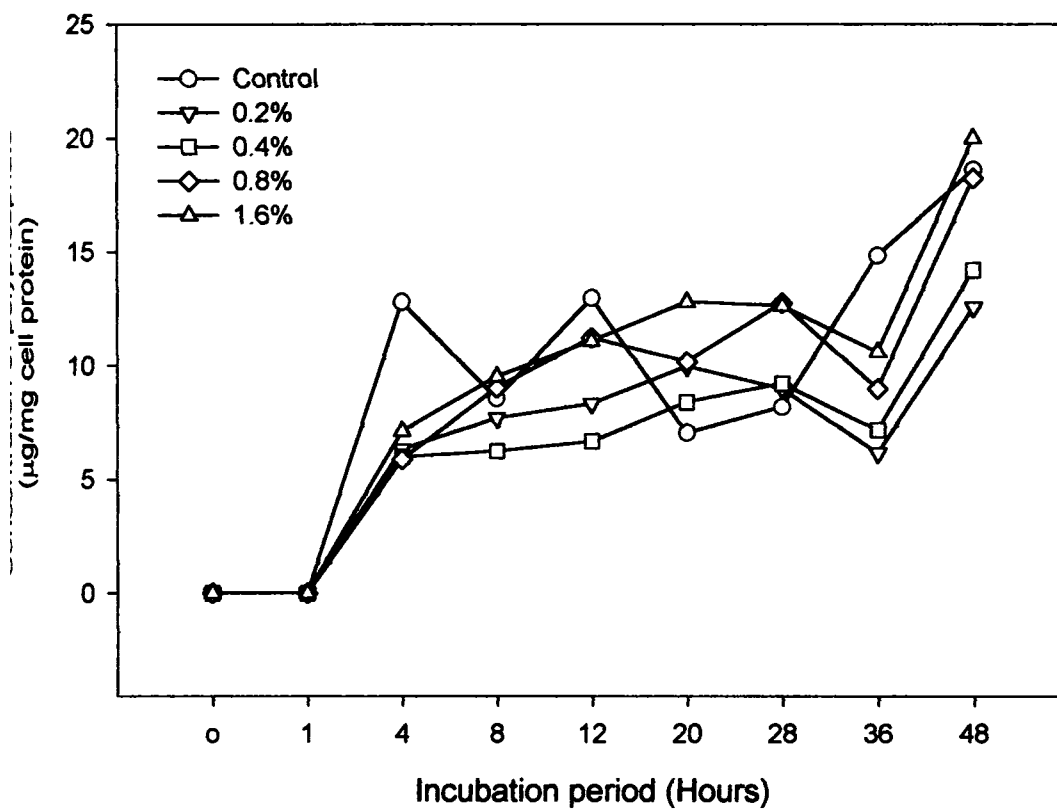
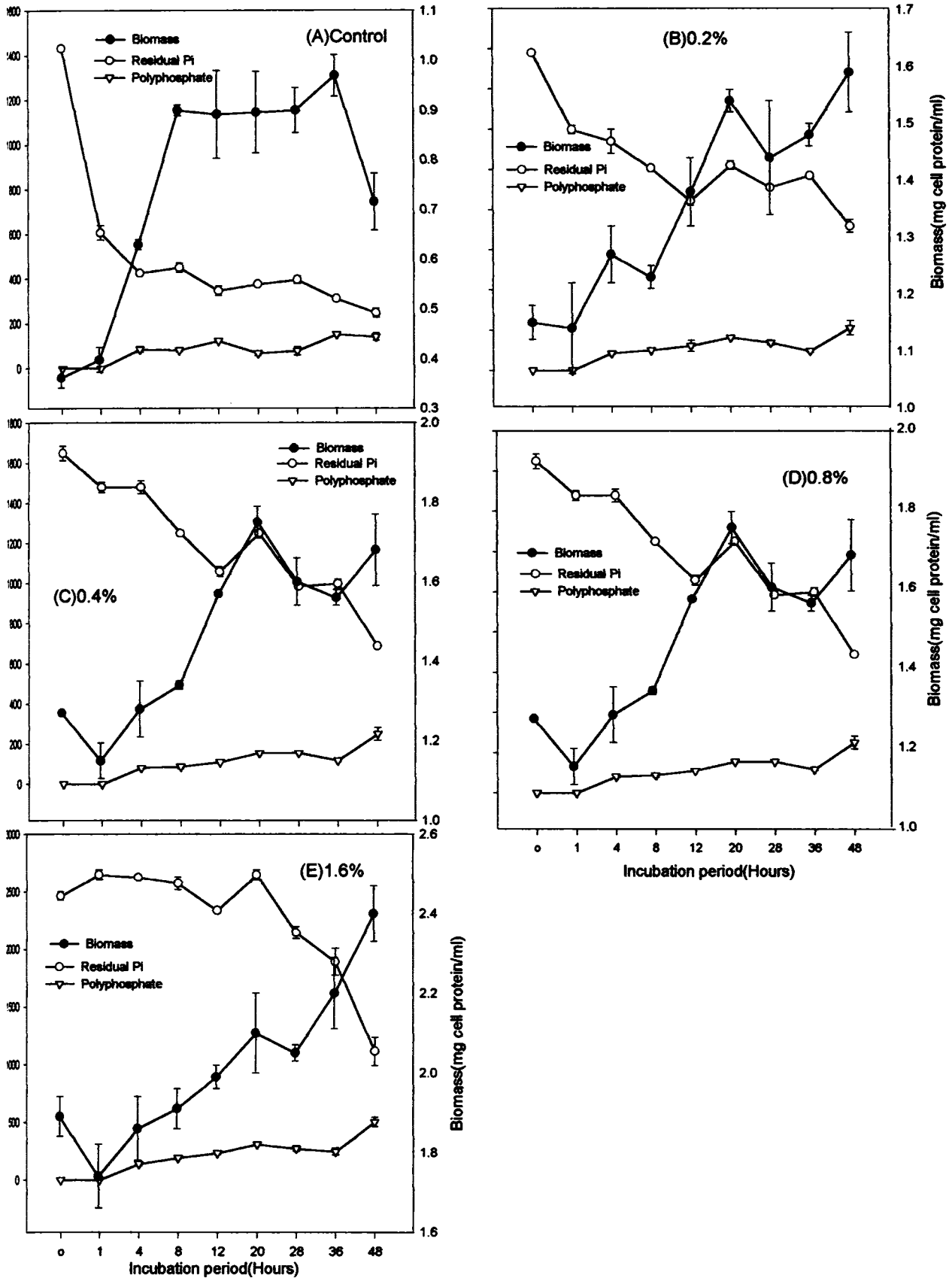

Fig.68 Effect of yeast extract on polyphosphate(polyP) accumulation by *Achromobacter* sp BTDS-64 during growth in Zobell's marine broth (ZMB)



69 Effect of yeast extract on biomass, Pi uptake and polyphosphate (polyP) accumulation by *Achromobacter* sp BTDS-64 during growth in Zobell's marine broth(ZMB)



slight increase during 36-48 hrs, along with decrease in biomass at conc. of 0.4% and 1.6% yeast extract.

Achromobacter sp

It is inferred from the results presented in Fig.67 that excess conc. of yeast extract in the cultivation medium affected the Pi uptake during 0-4 hrs, unlike that in the control. However, uniformly at all the conc. of yeast extract studied there was Pi uptake during 4-12 hrs and 20-48 hrs, although there was only marginal uptake indicated by reduction in the residual Pi conc. Whereas, there was rapid increase in residual Pi conc. during 12-20 hrs at all the conc. of yeast extract tested when compared to control. Increase in conc. of yeast extract led to decline in rate of Pi uptake during early hours, compared to rapid Pi uptake at later period of growth.

Data depicted in Fig.68 testify the positive impact of additional conc. of yeast extract on polyP accumulation by the growing cells. Thus, there was enhanced rate of polyP accumulation during 12-28 hrs and 36-48 hrs when compared to control medium. Interestingly increase in the initial conc. of yeast extract led to increase in the maximal levels of polyP, which were recorded at 48 hrs. However, a marginal decline in polyP levels was observed during 20-36 hrs at all the conc. of yeast extract studied, compared to that observed with control.

From the results documented in Fig. 69, it is seen that presence of additional conc. of yeast extract did influence the Pi uptake and polyP accumulation process by *Achromobacter sp*. In the control medium, Pi uptake and biomass were not positively related and rapid Pi uptake took place during lag phase. Whereas, at all the conc. of yeast extract Pi uptake occurred only during exponential phase and even during stationary phase. PolyP accumulation and yeast extract concentration were directly related in that increase in polyP was associated with increase in yeast extract.

3.8.3 Glucose

Vibrio sp

Presence of glucose as additional carbon source in the medium, did influence the rate of Pi uptake by cells during growth (Fig.70). Although there was decrease in residual Pi conc. in the medium, indicating Pi uptake, during 0-1 hr and 4-48 hrs, the rate of Pi uptake was very much reduced and only it was marginal when compared to that of control. Similarly when there was Pi

Fig.70 Effect of glucose on phosphate(Pi) uptake by *Vibrio* sp BTDW 128, during growth in Zobell's marine broth(ZMB)added with 500 μ M Pi

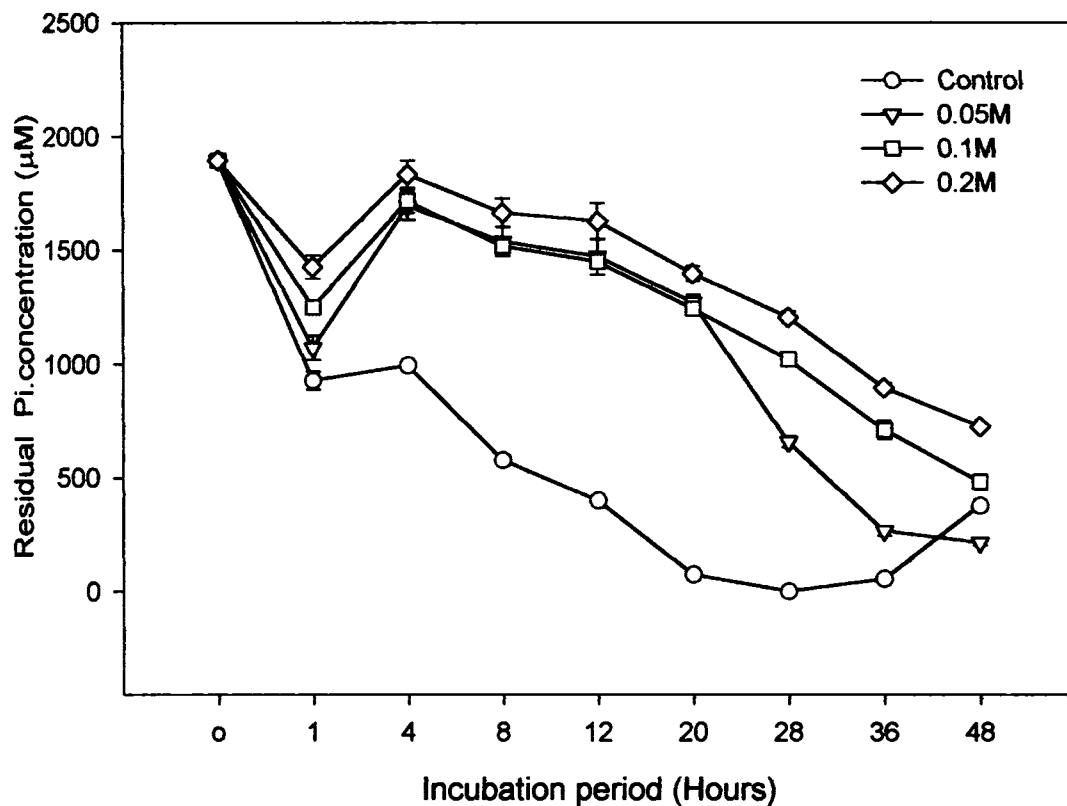
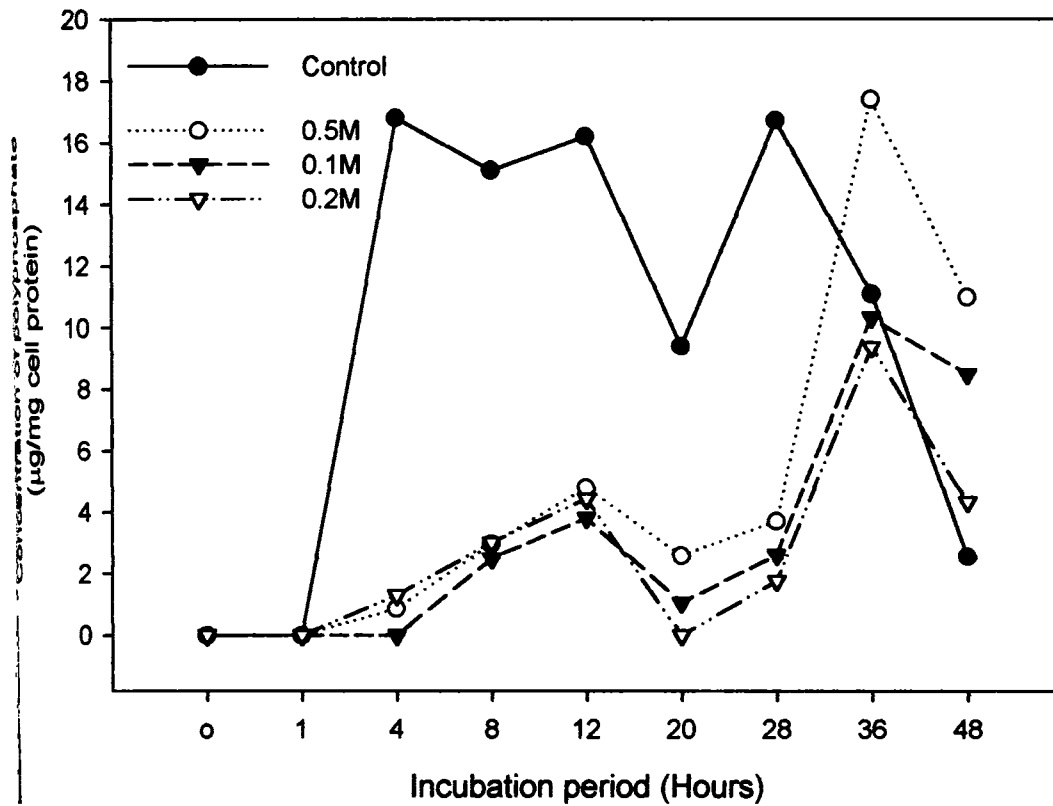

Fig.71 Effect of glucose on polyphosphate(polyP) accumulation by *Vibrio* sp BTDW-128 during growth in Zobell's marine broth (ZMB)added with 500 μ M phosphate



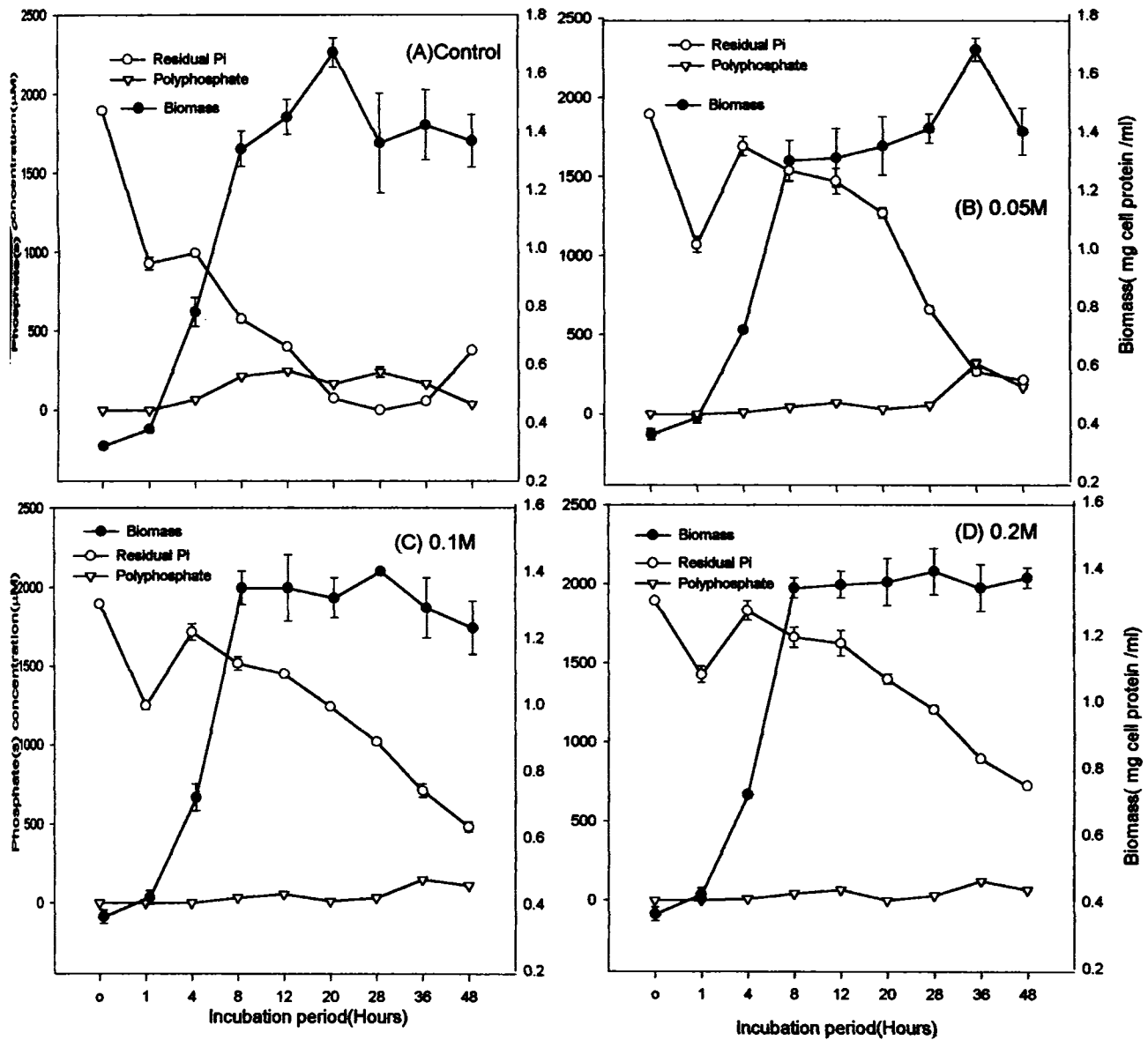

Fig.72 Effect of glucose on biomass, Pi uptake and polyphosphate (polyP) accumulation by *Vibrio* sp BTDW-128 during growth in Zobell's marine broth(ZMB)added with 500µM phosphate

release during 1-4 hrs, the rate of Pi release was high in the presence of glucose compared to the control medium.

Results presented in Fig.71 evidence the negative impact of glucose on polyP accumulation by *Vibrio* sp. During 1-12 hrs, the rate of polyP accumulation was drastically affected when compared to the maximum observed in the control medium. Uniformly, irrespective of the conc. of glucose, polyP recorded similar levels during 4-12 hrs and along with control recorded a decline in polyP during 12-20 hrs, followed by rapid increase during 20-28 hrs. However, while the polyP levels declined in the control medium during 28-48 hrs, there was increase in polyP during 28-36 hrs followed by a rapid decline in polyP during 36-48 hrs. In fact maximal level of polyP was recorded at 36 hrs in the case of 0.05M glucose conc. compared to all other conc. tested.

Data documented in Fig.72 clearly indicate the nature of relationship between the three variables evaluated during the course of study in response to varying conc. of glucose in the medium. Higher conc. of glucose in the medium above 0.05M led to a reduction in biomass accumulation, although there was no change in the various phases of growth. Further, in spite of decrease in residual Pi in the medium, irrespective of the glucose conc. in the medium, during 0-1 hr the level of decrease was lesser at high conc. of glucose (0.1 & 0.2M) indicating that glucose has repressed Pi uptake at higher conc. compared to lower conc. and in the control. Whereas, unlike that in the control, the residual Pi increased along with increase in biomass during 1-4 hrs indicating Pi release. Nevertheless, in the presence of glucose there was Pi uptake during the later period of growth, i.e. stationery phase. From the results, it is also inferred that polyP accumulation was affected in the presence of glucose. Increase in polyP was recorded along with increase in biomass in the control medium during 1-8 hrs while in the presence of additional glucose in the medium, increase in polyP was associated with decline in biomass at high conc. of glucose, during 28-36 hrs.

***Achromobacter* sp**

Very interestingly, both in the control medium and at the various conc. of glucose, the residual Pi levels recorded a uniform pattern of decrease during 0-1 hrs and marginal fluctuations during 1-48 hrs (Fig.73). However, it was noted that the level of reduction in residual Pi level was at a lesser magnitude indicating that Pi uptake by growing cells was affected by the presence of increasing conc. of glucose in the medium. In fact a marginal increase in Pi release was noted at 0.2M glucose compared to other conc. of glucose.

73 Effect of Glucose on Pi uptake by *Achromobacter* Sp BTDS-64, during growth in Zobell's Marine broth(ZMB)added with 500 μ M Pi

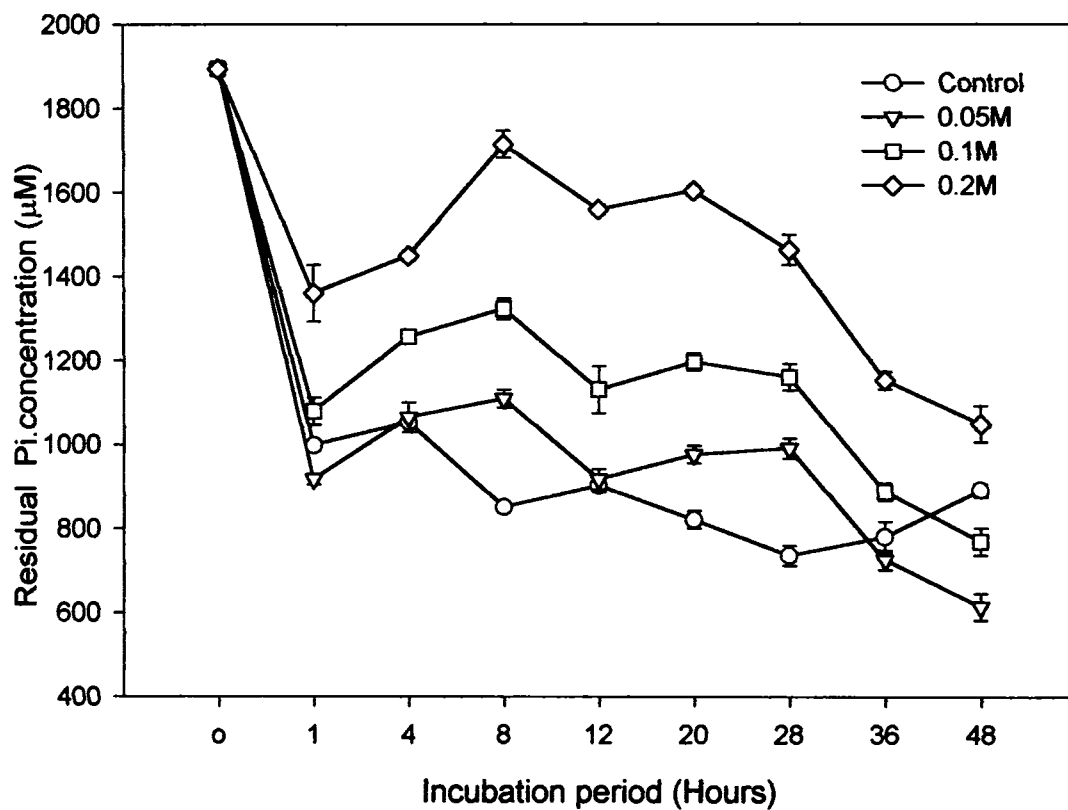
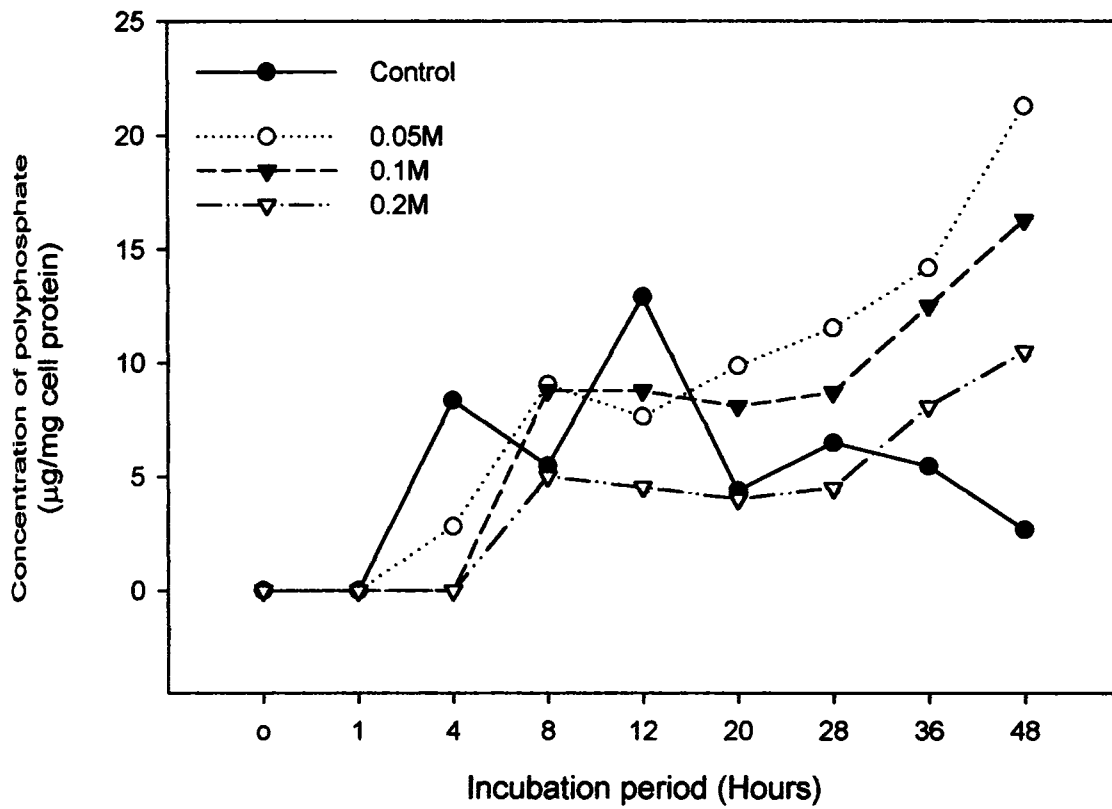

Fig.74 Effect of glucose on polyphosphate(polyP) accumulation by *Achromobacter* sp BTDS-64 during growth in Zobell's marine broth (ZMB)added with 500 μ M phosphate



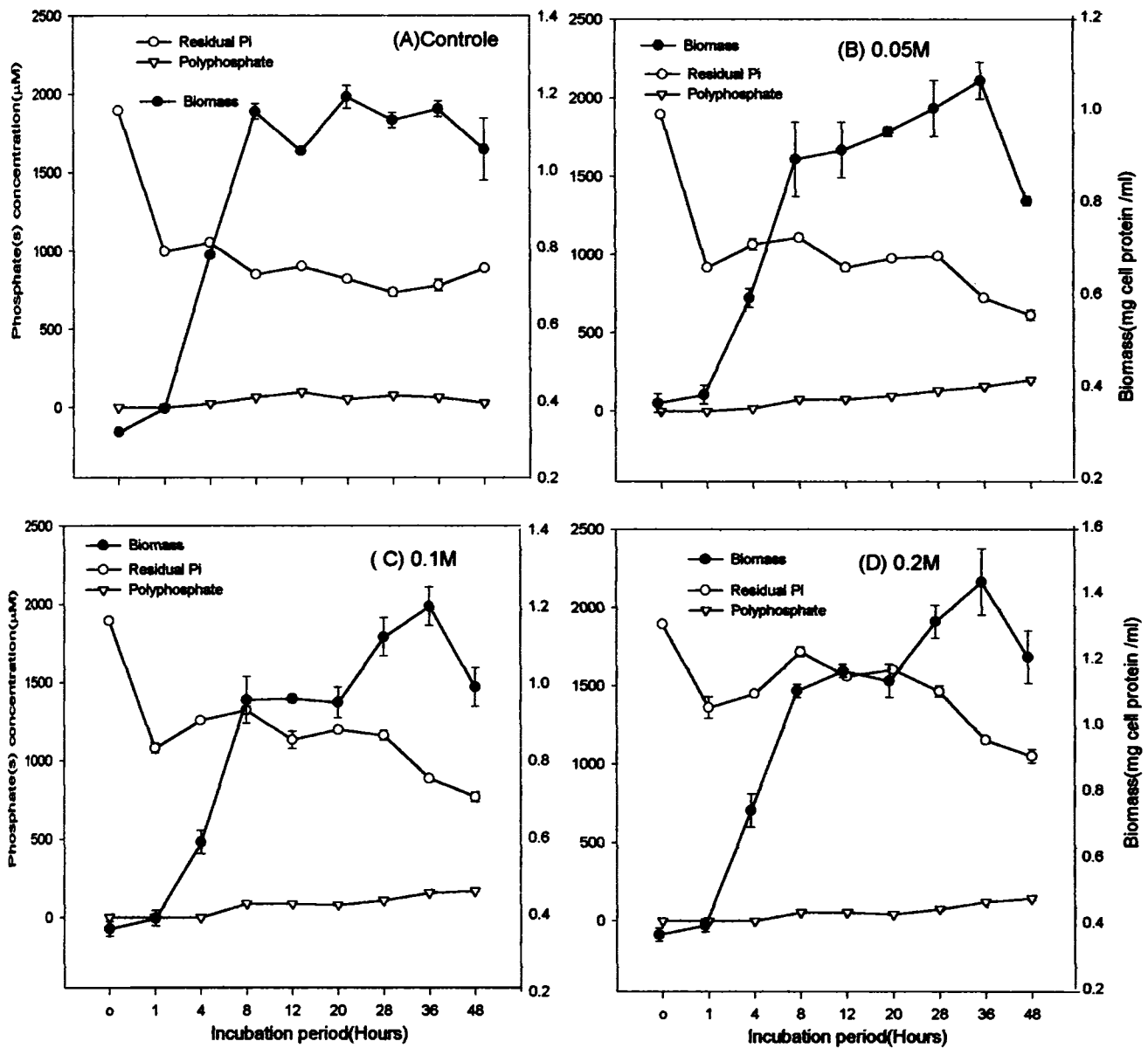

Fig.75 Effect of glucose on biomass, Pi uptake and polyphosphate (polyP) accumulation by *Achromobacter* sp BTDS-64 during growth in Zobell's marine broth(ZMB)added with 500μM phosphate

Results presented in Fig. 74 suggested that presence of additional conc. of glucose influenced significantly the rate of polyP accumulation by *Achromobacter* sp. While there was increase in polyP levels during 1-4 hrs in the control medium, in the presence of glucose, at higher conc. polyP accumulation happened during 4-8 hrs. Further, at 0.05M glucose, although polyP accumulation started after 1 hr, it continued till 48 hrs when the maximal polyP was recorded. Similarly maximal polyP was recorded at 48 hrs and the levels were higher than that of control. In fact no fluctuation in polyP was recorded for the varying conc. of glucose unlike that observed with the control medium.

Increase in biomass of *Achromobacter* sp was not significantly affected by the presence of increasing conc. of glucose (Fig.75). Even growth pattern was not observed to be influenced much by the presence of glucose. Similarly, Pi uptake pattern was identical with respect to all the conc. of glucose tested. Irrespective of the glucose conc., increase in biomass was associated with decrease in residual Pi during 0-1 hr and associated with increase in residual Pi during 1-8 hrs, indicating Pi uptake and Pi release respectively. Whereas, during 8-36 hrs, increase in biomass was associated with increase in Pi uptake irrespective of the glucose conc. in the medium. Increase in polyP was associated with increase in biomass and decline in residual Pi in the medium, irrespective of the conc. of glucose.

Results obtained for the glucose uptake by the marine bacteria during growth is presented in Fig.76. *Vibrio* sp showed a differential pattern of glucose uptake when compared with *Achromobacter* sp. In the case of 0.05M glucose conc., *Vibrio* could record continuous uptake of glucose until total depletion of given glucose in the medium by 12 hrs. Whereas, *Achromobacter* sp could not uptake glucose, in spite of an early uptake during 0-1 hr, which was released into the medium during the subsequent 1-4 hr. At 0.1M glucose conc., although there was no glucose uptake till 8 hrs, during later hours the glucose level declined indicating total glucose uptake by the *Vibrio* sp. Whereas, in the case of *Achromobacter* sp, instead of glucose uptake there was release of glucose into the medium from cells until 8 hrs, which remained same during the rest of the period of study. At 0.2M glucose, *Vibrio* sp recorded a rapid uptake of glucose during 0-1 hr, followed by rapid release during 1-8 hrs. However, the released glucose was reabsorbed later during 12-48 hrs. Whereas, in the case of *Achromobacter* sp there was no glucose uptake and instead only release in the medium.

Fig.76 Glucose uptake by *Vibrio* sp BTDW-128 and *Achromobacter* sp BTDS-64, during growth in Zobell's Marine Broth (ZMB) added With 500 μ M phosphate

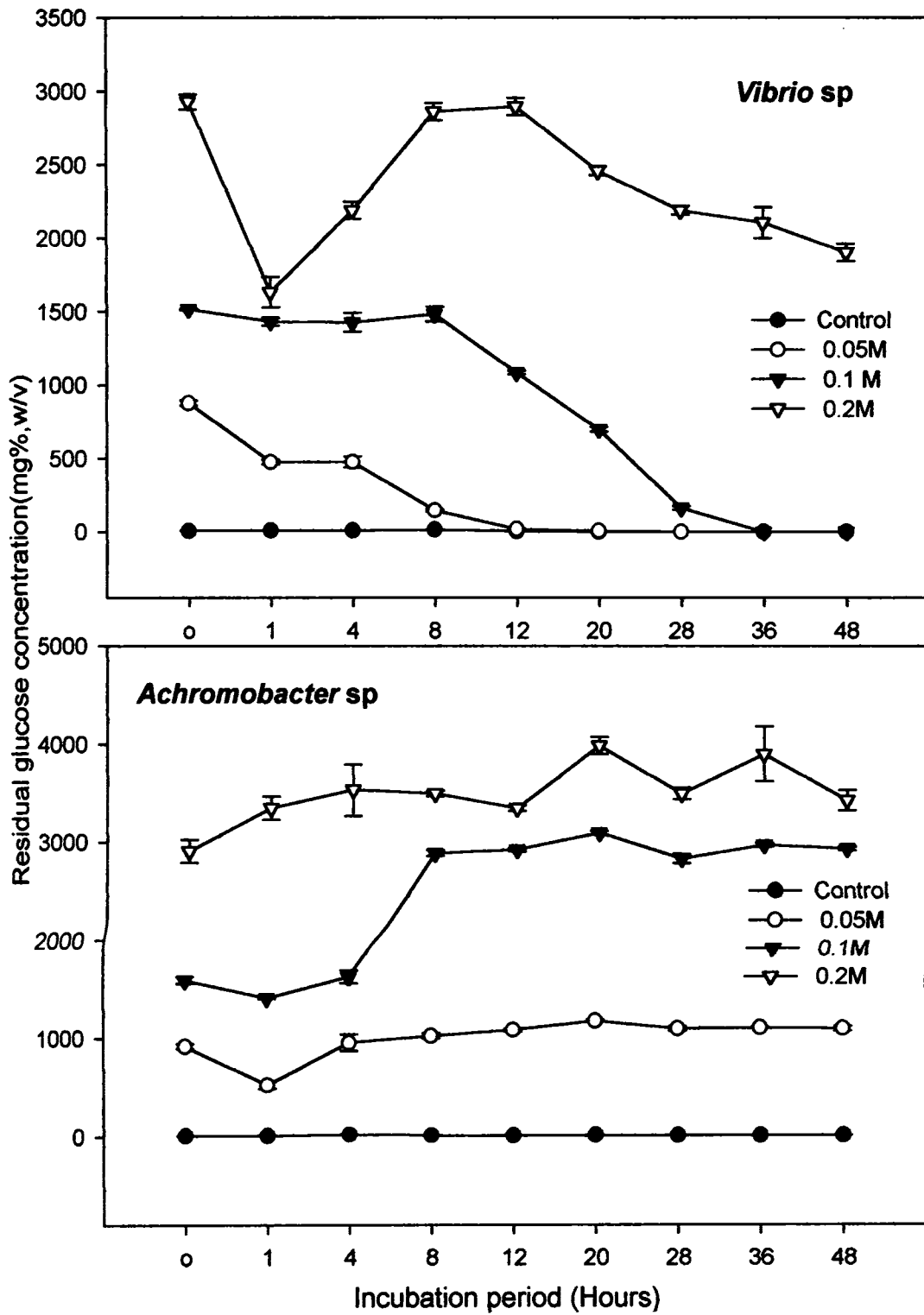

4. DISCUSSION

Accumulation of phosphate is a constant process in the marine environment resulting from the death and decay of the inhabitant plants and animals as well as from the inflowing waters carrying wastes from the land. Marine bacteria are thus exposed to higher Pi concentration in the environment and have become part of the active phosphate cycle of the marine ecosystem. Thus they are expected to have relatively better Pi uptake and polyP accumulation, besides tolerance to osmotic and toxic stress, for probable exploitation in the wastewater treatment and other applications.

Bacteria use inorganic phosphate as the preferred source of phosphate. Under conditions when Pi is in excess, it is taken up by the Pi inorganic transport system (Pit), which is made constitutively in the cell (Wanner 1996). Under these conditions bacteria can store Pi in the form of polyphosphate as a reserve for Pi and other functions (Kornberg 1995). Since polyP can serve as a Pi source for the biosynthesis of nucleic acids, phospholipids and other biochemical molecules under the conditions of Pi starvation, its accumulation is likely to be a protective mechanism for survival during Pi starvation (Harold 1963).

Results obtained from the present study very clearly testified the potential of marine bacteria, irrespective of their sampling location and source, for active Phosphate uptake and polyphosphate accumulation during growth. Thus among the 540 isolates, obtained from both sea water and marine sediments about 96% of both water and sediment cultures showed 90-97% phosphate removal by 24 hrs. The sediment cultures showed high efficiency to remove Pi above the range of 94 % indicating that they are relatively better in Pi uptake compared to those obtained from seawater. The lowest Pi clearance recorded was 86% against the maximum of 97.8%, after 24 hrs. of incubation in the medium.

Majority of the marine bacterial isolates, irrespective of their source of solation whether seawater or sediment, could accumulate polyP in their cells upto >35 µg/mg cell protein. However, a majority of isolates, well above 15%, could record polyP only around 11-20 µg /mg cell protein. Relatively, isolates obtained from seawater were capable of accumulating enhanced levels of polyP compared to the isolates of marine sediments. The observed results enunciate the fact that marine bacteria are well poised for Pi uptake and polyP accumulation by virtue of their existence in nature

in marine environment where they are constantly exposed to high Pi conditions. Marine sediment bacteria are naturally exposed to Pi rich conditions than seawater and thus in the present study marine sediment isolates showed better performance than seawater isolates.

Based on the results of first phase screening, 26 isolates obtained from both seawater and marine sediment which recorded high Pi uptake and PolyP accumulation were short listed and subjected to second phase screening. The selected strains were mainly heterotrophs and were identified as species of *Vibrio sp.*, *Staphylococci sp.*, *Acinetobacter sp.*, *Pseudomonas sp.*, *Arthrobacter sp.* and members of the family *Enterobacteriaceae sp.* From the results it was inferred that all the isolates irrespective of their source and affiliation to different genera indicated that their logarithmic phase of growth was during 4-8 hrs. and they are rapid growing cultures.

Both *Staphylococci sp.* and *Achromobacter sp.* could effect >50% of Pi removal from the medium compared to other species. All the isolates could effect almost >60% of Pi except *Achromobacter sp.* which could record only 57.03% of Pi removal at the end of 4 hrs. of growth, after which the isolates entered into their logarithmic phase of growth. On the other hand *Arthrobacter sp.* could record 78.9% Pi removal. Very interestingly, all the isolates recorded a decline in the percent of Pi removal after 8 hrs. In fact 4-8 hrs. was observed as logarithmic phase and there was Pi release into the medium resulting in decline in % Pi removal. Nevertheless, there was steady increase in the rate of % of Pi removal irrespective of the isolates during stationery phase of growth. Except *Achromobacter sp.* (71.8%) and *Acinetobacter sp.* (92.15%) all the other isolates tested could remove a maximum of 98.8-100%. Species of *Vibrio sp.* isolated from marine sediments removed Pi at a higher rate compared to their sea water counterparts.

Studies with *Acinetobacter sp.* have showed that the largest quantity of Pi was removed within the first hour during the lag phase compared to 24 hrs uptake (Muyima and Cloete, 1995) and results also indicated that Pi was released slowly between 2 and 8 hours and removed significantly after 24 hrs. Excess Pi removal has been reported to occur mainly under aerobic conditions while Pi uptake and release processes are reversible (Ohake *et al*, 1985). In the activated sludge process when the aerobic phase of the cycle exceeded 4 hrs, a slow release of Pi occurred even during the aerobic phase (Osborn and Nicholls 1978). However, the intracellular phosphate accumulation vary according to the environmental factor (Kukev and Vagobov 1983).

When *E.coli* cells accumulated excessive levels of polyP, they released it into the medium, may be a mechanism by which a further increase in cellular polyP is limited. This release was first

observed during Pi uptake experiment with *E.coli* MV 1184 strain (Kato *et al.*, 1993 a). Rate of polyP release was essentially equivalent to that of Pi uptake after the cells accumulated excessive levels of it and stopped when the Pi in the medium was removed completely, and resumed on addition of Pi to the culture. PolyP release was stopped when the Pi uptake was inhibited by 0.1mM carbonyl cyanide m– chlorophenyl hydrazone (Hardoyo *et al.*, 1994)

The ATP regenerating system consisting of ADK, PPK, and polyP was shown to be promising for practical utilization of polyP as ATP substitute (Kornberg 1995) .In *E.coli* highest amount of high polymer polyP occurred only at the end of latent and beginning of logarithmic growth phase. When the culture entered in to exponential growth, the level of intracellular polyP dramatically decreased. Thus, polyP accumulation preceded active growth and it is utilized by the growing cells (Nesmeyanova, 2000).

All the isolates tested could record considerable level of Pi as cellular free Pi fraction during growth. However, an interesting phenomenon was noted with most of the groups. The cellular free Pi concentration after recording a drastic decline after 4 hrs., increased during the subsequent incubation period, in spite of a fluctuation at 16 hrs for all the isolates. Species of *Staphylococci*, *Acinetobacter* and *Enterobacteriaceae* isolated from seawater, recorded an increase in Pi level at 2 hrs followed by a rapid decrease at 4hrs., unlike other species which showed a gradual decline during 1-4 hrs. Further, except species of *Arthrobacter* and *Achromobacter*, which showed a reduction in cellular free Pi at 40 hrs., all the isolates of other species tested showed progressive increase in cellular free Pi during 24 hrs. to 7 days. However, maximal level of cellular free Pi was recorded, in the range of 1129-1468 µg only after 64 hrs. The variation in Pi uptake efficiency for the different species evidence the diversity among the marine bacteria.

From the data it was also evident that none of the isolates accumulated polyP during the first hour of growth. PolyP accumulation in all the tested bacteria was observed to commence only after 1 hour of growth, which reached a maximum after 4 hrs. except in *Arthrobacter sp.*, *Achromobacter sp.* and *Pseudomonas sp.* for which maximal polyP was recorded at 2 , 24 and 40 hrs. respectively. An interesting observation made during the study was that, all the isolates spent their polyP during active logarithmic phase, since rapid decline in the level of polyP was recorded during 4-8 hrs. followed by a marginal decrease during 8-16 hrs. PolyP levels were very low in the cells during stationery phase, (24 hrs – 7 days) when compared to the exponential phase.

In general different species of bacteria have different growth curve pattern and generation time. Thus there was difference in the level of polyP accumulated by the cells of different species tested. However, there was some uniformity among the different genera. For instance all the isolates irrespective of the species did not accumulate polyP during early lagarithmic phase. Whereas, maximal polyP was accumulated during logarithmic phase for few species and during stationary phase for *Achromobacter* sp and *Pseudomonas* sp This evidence species diversity in terms of their polyP accumulation machinery and mechanism in different species of marine bacteria.

Seawater isolates recorded a rapid removal of 47.11% of Pi from the medium during the first hour of growth, compared to 41.58% of Pi removal by the sediment isolates. However, both the isolates of sea water and sediments showed identical trend of a marginal release of Pi into the medium at 2 hrs., followed by a rapid removal of Pi during 2-4 hrs. The period of incubation, 4-8 hrs, considered as logarithmic phase witnessed a decline in the percent removal of Pi indicating release of Pi into the medium. Nevertheless, the percent of Pi removal recorded a continuous increase during 8-64hrsreaching a maximum at 64 hrs (99.23% and 96.27% respectively for seawater and sediment isolates). While Gram -ve isolates recorded an identical pattern of increase and decrease in percent removal of Pi very much like that of seawater and sediment, Gram +ve isolates recorded continuous increase in Pi removal throughout the course of growth, except at 8 hrs, and on the 7th day, when there was a marginal reduction in the % of Pi removal. Further Gram +ve strains recorded enhanced levels of % Pi removal compared to Gram -ve isolates right from the early phases of growth.

Isolates obtained from seawater and sediment recorded very similar trend of levels of concentration cellular free Pi in the cells. Thus, all the isolates recorded a gradual decrease in the concentration of cellular free Pi during 1-4 hrs, after recording a high level Pi at 1 hr. However, the cellular free Pi level increased later continuously throughout the period of growth except for the decrease at 16 hrs. Interestingly, increase in cellular free Pi level coincided with the logarithmic and stationery phases of growth. While Gram -ve isolates showed a similar trend that of water and sediment isolates, Gram +ve isolates recorded alternating increase and decrease and consequent fluctuation in the levels of cellular free Pi during the course of growth.

All isolates of seawater and sediments, as well as Gram -ve and Gram +ve, showed wide variation and fluctuation, in terms of increase and decrease in the levels of low molecular weight

Pi during growth. Nevertheless, there was a uniform pattern during lagarithmic and logarithmic phase of growth.

Although no low molecular weight phosphate could not be recorded at 1 hr they increased till 4 hrs to a maximum. However, this high concentration of low mol. Wt. Phosphate declined rapidly during 4-8 hrs, such that very low level was recorded, indicating that low molecular weight phosphates decreased during active exponential growth phase. There was an alternating increase and decrease in the phosphate level in the cells during subsequent period of growth. An identical trend was also observed with Gram -ve and Gram +ve isolates.

Inspite of no polyphosphate accumulation during the first hour of growth, polyP increased gradually to a maximum of 25.94 and 29.14 µg/mg cell protein respectively for the isolates of sea water and sediment, and 27.73 and 35.69 µg /mg cell protein respectively for the Gram -ve and Gram +ve isolates, after 4 hrs. However, polyP levels rapidly declined to a minimum, during the subsequent period of 4-16 hrs.(logarithmic phase). Although polyP recorded considerable increase at 24 hrs, irrespective of the source of isolates or Gram -ve or Gram +ve, declined later, rapidly, again during 24-64 hrs. This observation suggested that polyP accumulation does not take place during stationery phase. Results computed for the isolates of seawater and sediment, as well as Gram +ve and Gram -ve, testify the rare characteristics of marine bacteria., Irrespective of their source, whether seawater or sediment, the isolates demonstrated identical and unique characteristic of their environment., In fact the behaviour of the isolates of marine environment reflect the function of marine environment.

Based on the results obtained during second phase screening two strains namely *Vibrio* sp. BTDW 128 and *Achromobacter* sp. BTDS 64 which showed contrasting characteristics were selected and subjected to further studies. Of them *Vibrio* sp. BTDW 128 could demonstrate, obviously, accumulation of high levels of polyP, and unlimited Pi uptake and release properties. *Achromobacter* sp. BTDS 64 showed limited capacity for Pi uptake and polyP accumulation.

Impact of various environmental factors on phosphate uptake from the medium as well as polyP accumulation was evaluated using ZoBell's Marine Broth. The various parameters studied included different concentration of phosphate in the cultivation medium, pH, temperature, different concentration of additional NaCl, Potassium chloride, Calcium chloride Magnesium sulphate, Sodium citrate, Ammonium nitrate, Peptone, Yeast extract and Glucose. The detailed results

presented under the chapter Results, in fact, give a direct evidence for the differential response of the two bacteria to the varying levels of environmental and nutritional parameters.

Impact of varying concentration of phosphate, in the ZoBell's marine broth on the rate of phosphate uptake and polyP accumulation by marine bacteria was studied using KH_2PO_4 as source of phosphate. Very interestingly, at all the conc. of Pi tested, *Vibrio* sp, recorded rapid uptake of Pi during the one hour of growth itself and the rate of Pi removal was proportionately high along with the increase in the initial conc. of Pi in the medium. However, during 4-8 hrs. (log phase), at conc. of Pi above $500\mu\text{M}$, there was no Pi uptake into cells, instead there was release of Pi into the medium. Nevertheless, at all initial Pi conc. tested there was complete removal of Pi from the medium during later hours of growth, after 20 hrs.

In general, rate of polyP accumulation was concordant with increase in the conc. of Pi in the medium and Pi uptake. Rapid Pi uptake by cells during the first hour of growth was concordant with increase in biomass, invariably at all the Pi conc. tested. Whereas, after 1 hr., there was differential response by the cells for the various Pi conc. tested. Thus the rate of Pi uptake declined rapidly during 1-8 hrs. of growth, irrespective of increase in biomass, except for the initial Pi conc. of $9000\mu\text{M}$ and $12000\mu\text{M}$. Interestingly, in the control medium, (ZMB without additional Pi conc.) polyP increased and decreased concomitantly with increase and decrease in Pi uptake respectively during 20-28 hrs and 28-36 hrs., while biomass showed a negative relationship. At other occasions, there was no clear relationship between biomass and polyP accumulation. This observation testify the unlimited capacity of the *Vibrio* Sp. BTDW-128 to remove Pi from the medium. *Achromobacter* sp. could rapidly uptake Pi during the first hour of growth, during lag phase and the rate of Pi uptake increased along with increase in initial conc. of Pi in the medium. However, after one hour there was no rapid Pi uptake. In fact at all the higher levels of initial Pi conc., there was a marginal Pi uptake during 8-12 hrs and 38-48 hrs and a gradual release of Pi into the cells during 12-36 hrs. Whereas, both in the control medium and at $500\mu\text{M}$ Pi conc. there was neither uptake of Pi or its release. The percentage of Pi removed from the medium decreased as the Pi conc. increased. The maximal uptake was about 80% in the control while only 40-60% in Pi added growth. However, there was significantly high Pi uptake following the onset of stationary phase, around 12 hrs followed by an almost equal release in all the Pi added growths, above the $500\mu\text{M}$.

Rapid accumulation of polyP took place during 1-4 hrs at all the conc. of initial Pi and in the control medium, except at 500 μM Pi, where the rate of polyP accumulation was relatively less. Nevertheless, irrespective of the initial Pi conc. tested the polyP level declined during 4-8 hrs, while, there was differential response during the later period of growth. Thus, in the control and at 500 μM , Pi conc. polyP increased during 8-12 hrs. followed by rapid decline during 12-20 hrs. Whereas, in contrast, at higher conc. of initial Pi (3000 μM - 12000 μM) polyP levels declined initially during 8-12 hrs., and increased rapidly during 12-20 hrs. In general even the highest polyP conc. attained by the *Achromobacter* sp. was only $\frac{1}{4}$ of that of the *Vibrio* sp. despite the increase of Pi in the medium.

There was an increase in the rate of Pi uptake along with increase in biomass during the first 4 hrs of growth except at 3000 μM Pi conc., where the Pi uptake declined along with increase in biomass during 1-4 hrs. Pi uptake and PolyP accumulation had a positive relation of concomitant increase during 1-4 hrs. at all the Pi conc. tested, except at 9000 μM and 3000 μM when the polyP increased along with decrease in Pi uptake. Biomass and polyP accumulation also had a concordant increase at all the conc. of initial Pi tested, except at 6000 μM and 9000 μM .

Despite a high Pi accumulation in *Achromobacter* sp. its conversion to poly P is apparently very poor compared to that of *Vibrio* sp. where polyP formed a significant proportion of both cellular Pi and dry cell weight. Moreover, there is a tremendous progressive release of Pi from the cells back into the medium after its peak uptake at 12 hrs in *Achromobacter* sp. unlike *Vibrio* sp. in which this phenomenon was never seen. All these observations indicate deficiency of *Achromobacter* sp. in converting and storing Pi in the cell as polyP and utilizing the same later. More over the pattern of Pi uptake and release in the various growth phases of *Vibrio* sp. strongly suggest probable functioning of different Pi transport mechanisms during these phases. Unlike *Vibrio* sp, in *Achromobacter* sp. the stationary phase Pi transport mechanism is leak prone and is evident from the alternate phases of uptake and release unlike *Vibrio* sp.

Adjusting pH of the media significantly altered the original free Pi concentration of the medium itself. On acidifying to pH 6.0 there is significant increase in the free Pi, due to the probable release from protein and other soluble complexes. When the pH was shifted to the alkaline side there was tremendous reduction in free Pi in the medium. These observations indicate one of the mechanisms how pH can affect cellular growth and other functions, especially Pi uptake and polyP. While the initial Pi concentration was reduced to $\frac{1}{3}$ rd of the initial Pi conc. at pH 8, there was no detectable level of free Pi at pH 10 and 12 before inoculation. The disappearance of free Pi in the

medium might be due to the formation of calcium biphosphate in the medium under alkaline pH (Thomas and Anke, 1997).

In the present study, at pH 10, free Pi in the medium progressively increased after 4 hrs till the stationary phase, followed by a decline, indicating that Pi was mobilized from its complexes, probably by the release of alkaline phosphatase in excess. Actual uptake of Pi by the *Vibrio sp.* could not be estimated at higher pH due to Pi complex formation and its release. Whereas, the mechanism of Pi uptake or Pi removal was not affected significantly at pH 6-10.

The results obtained in the present study indicate that the Pi uptake by the *Vibrio sp.* was unaffected by alterations in the pH range of 6-10, although at alkaline pH the actual Pi uptake could not be estimated by chemical method because of the phosphate complex formation and release in the medium. Ofcourse a detailed study using labeled Pi may enable accurate measurement. The results also suggested a lesser pH tolerance of *Achromobacter sp.* in Pi uptake with a relative pH optima in the range of 7-8. In *Vibrio sp.* polyP was detectable at all pH studied varying from 6 to 12, and pH 12 showed only insignificant polyP level. The results further testify that a relative pH optimum of pH 7-8 is favorable for polyP formation. Unlike *Vibrio sp.*, the *Achromobacter sp.* strains showed absolute pH optima of 8-7 and polyP was significantly reduced at other pH. These observations suggest a probable difference in the respective PPK enzyme of the two bacterial strains.

Variation in incubation temperature did not influence significantly the rate of phosphate uptake by *Vibrio sp.* which when grown at temperatures higher than the room temperature, recorded, at all the temperatures tested, significant reduction in the rate of Pi uptake. Though there were no significant differences in Pi uptake for the temperatures tested, there was significant reduction in Pi uptake at 55°C. However, irrespective of the temperature studied and differences in the initial conc. of Pi, the final level of Pi removal was close to that of the control at room temperature.

Rapid accumulation of polyP during the onset of stationary phase, at higher temperature suggest a rapid and very high utilization of polyP during the exponential phase and later part of the stationary phase in response to in high temperature stress. The results suggest a probable physiological role for polyP during growth and survival under stationary phase at higher temperature.

Although increase in temperature retarded the rate of Pi removal by the *Vibrio sp.* finally the rate of Pi removal revived back at all temperatures ranging from 30 to 55°C. Unlike *Vibrio sp.*, in *Achromobacter sp.*, Pi uptake increased with increase in temperature. Increase in temperature led to proportionate increase in the rate and efficiency of Pi removal by *Achromobacter sp.* At 55°C the Pi removal was almost complete, twice that of control with *Achromobacter sp.* and almost as high as that of *Vibrio*. The results indicated high temperature tolerance and adaptability of the Pi transport system of *Achromobacter sp.* as well as the critical physiological importance of accelerated Pi uptake for growth and survival under higher temperature stress. Enhanced and almost complete Pi removal at higher temperatures attribute a metabolic role for Pi for growth and survival of marine bacteria under the temperature stress.

PolyP increased almost proportionately with the increase in temperature. The consistent changes in polyP, in the two bacterial strains suggest conservation of its physiological role in growth of these bacteria under high temperature stress. Further maximal polyP recorded at 55°C indicate that the bacteria accumulated polyP as a part of adaptation and as a food reserve.

In marine *Chromatium sp.* intracellular phosphate and polyP content increased up to and 40-50% seawater (Hiroaki *et.al.* 1997). In the present study, when compared to the control, all the test media added with NaCl showed a reduction in the initial conc. of Pi available in the medium. Similar changes have been reported earlier from pH studies (Thomas and Anke, 1997). During the present study it was observed that during the first hr, unlike the control where there is rapid uptake all at the test conditions showed rapid mobilization of Pi into the medium from some phosphate complexes or partly by release of Pi. Apparently increase in Pi in the medium could have masked the actual Pi uptake by cells, probably due to the release of alkaline phosphatase. Mobilization of Pi from insoluble complexes even when significant amount of free Pi is available in the medium, needs to be understood. Probably this could be attributed to the biphasic pumping system of Pi pumps where one will be active at a higher Pi concentration while the other will be active only at lower Pi concentrations, phosphate specific transport system (Pst). From the overall results, it is more likely that a specific, and active irreversible Pi uptake mechanism starts functioning only after the onset of the stationary phase and a minimal threshold Pi level might be needed to activate the initially expressed pump which act at higher Pi level.

Except at 20 hrs polyP at all the tested conditions remained significantly lower than the control and a polyP peak was recorded immediately after the onset of stationary phase following a marked uptake of Pi after 12 hrs. At 20 hrs there was an increase in Pi in the medium indicating

release of Pi during stationary phase due to probable action of specific phosphatase enzyme mobilizing the Pi in the medium from the Pi complexes. Although lower in magnitude the stationary phase polyP peak occurred at all tested NaCl conditions evidencing the conservation of active polyP synthesis even at such a high salt concentration.

The pattern of Pi uptake in *Achromobacter* sp. was almost similar to that of *Vibrio* sp. till 12 hrs. Later there was significant release of Pi in to the medium indicating definite decompensation and failure in Pi uptake (removal) from the medium.

Despite the high saline stress both *Vibrio* sp. and *Achromobacter* sp. strains proved to be high salt tolerant with appreciable growth and survival, maintaining a biomass equitable to that of control throughout the growth cycle. The rate of Pi uptake was slow and in test conditions compared to the control. The Pi uptake patterns and efficiencies of the high polyP *Vibrio* sp. and low polyP *Achromobacter* sp., suggest that Pi transport systems are influenced by sodium chloride conc. drastically in *Achromobacter* sp unlike *Vibrio* sp, or polyP has some positive role in Pi uptake under saline stress, in one way or another.

Although there were reductions in magnitude, the course of changes in polyP were almost intact in both cultures even under high salt stress. Moreover, appearance of polyP peak at early stationary phase, and its turnover indicate salt tolerance of polyP metabolizing enzymes in the cells.

In the *Vibrio*, sp. as the NaCl concentration increased there was progressive reduction in Pi uptake and polyP. However, the proportion of polyP per Pi uptake significantly increased with increase in NaCl concentration. All the levels of NaCl conc. tested showed a greater proportion of polyP than the control suggesting a possible physiological importance in salt tolerance. In *Achromobacter* sp also there was enhanced conversion of a significantly greater proportion of the Pi into polyP, which reached as high as 76% of the Pi uptake at 0.7M NaCl, The Seawater contains all the elements of the periodic table and it is relatively rich in Pi, Ca, Mg, and Na compared to fresh waster, the cations are reported to increase Pi uptake and PolyP accumulation in a variety of microorganisms (Healey 1982; Van Groenestijn *et.al.*, 1988). In the marine *Chromatium* sp. studied polyPi/Pi ratio was found to be 2.1 with intracellular Pi content of 0.865 $\mu\text{M}/\text{mg}$ dry weights. *Chromatium* sp., which showed increase in polyP with increase in NaCl up to 280 mM level (Hiroaki, 1997).

Whereas, that of *E.coli* reported to be 1.1 and 0.645 respectively (Kato *et al.*, 1993a). Several divalent cations stimulate the polyphosphatase activity and Mg^{2+} , CO^{2+} , Mn^{2+} , Zn^{2+} have been studied in the yeast mitochondrial soluble polyphosphatase (Lichko, *et al*, 2000). Ca^{2+} replace Mg^{2+} from the inorganic pyrophosphatase of *E.coli* inhibiting the enzyme activation and catalysis. Ca^{2+} is a powerful inhibitor of all known pyrophosphatases.

In *Vibrio sp.* polyP level remained significantly lesser in the presence of excess conc. of KCl compared to that of the control. There were no significant differences in the polyP levels in response to varying KCl conc. The lowest Pi uptake was noted at highest KCl concentration (0.035M) and during the decline phase it showed significant release of Pi raising the residual Pi level almost close to the initial level.

Unlike *Vibrio sp.*, the *Achromobacter sp* showed marked increase in polyP invariably at all the test conditions compared to the control. Despite the significant reduction in the overall Pi removal from the medium the *Achromobacter sp.* showed a significant increase in growth and polyP accumulation in the presence of added KCl especially in the 0.014-0.021 M range. Probably excess conc. of KCl might have enforced stress on the cells and led to consequent enhancement in polyP accumulation.

Both *Vibrio sp.* and *Achromobacter sp.* were found to tolerate additional conc. of KCl in the medium. The results indicated that additional KCl in the medium accelerated the early Pi uptake. In the *Vibrio sp.* the additional KCl led to a lag in Pi uptake after initial 1 hr. and there was no significant Pi release till the decline phase. Unlike *Vibrio sp.*, the *Achromobacter sp* showed significant Pi release after initial Pi uptake during 1 hr. consistently in all the test conditions, and this was more marked with the higher conc. of KCl.

Vibrio sp and *Achromobacter sp* responded differently in the presence of excess KCl in the medium. There was marked increase in growth of *Achromobacter sp.*, while both strains showed slow and lower Pi uptake compared to the control. While the *Vibrio sp.* recorded significant low polyP, the *Achromobacter sp.* showed marked elevation in the polyP levels at all the tested KCl conc. indicating the physiological divergence in these bacteria in response to the excessive KCl levels in the medium.

The effective maximal Pi uptake and polyP were significantly low at all the tested conc. of KCl compared to the control. In *Achromobacter sp.* although the effective Pi removal was significantly reduced by excess KCl in the medium, there was a significant increase in polyP.

The initial free Pi conc. in the medium was markedly reduced to as low as 5-30 times compared to the control, when excess calcium was added into the medium, This reduction in Pi may be attributed to the formation of insoluble calcium biphosphate complex in the medium (Thomas and Anke,1997) proportionate to the amount of CaCl₂ added. Despite the initial difference in the conc. of free Pi in the medium there was rapid uptake of Pi during growth leading to reduction in the residual Pi in the medium equal to that of the control, at 12 hrs. During the stationary phase there were fluctuations in Pi conc., indicating a probable mobilization of Pi from the phosphate complexes by specific alkaline phosphatase enzyme released into the medium during stationary phase. However, estimating the absolute uptake in these situations demands studies using labelled phosphorus.

However, the characteristic pattern of polyP might be reflecting phases of mobilization and depletion of Pi in the medium from the phosphate complex. The highest level polyP in the 0.09M CaCl₂ indicate some physiological role of polyP in CaCl₂ stress response and in fate of excess Ca in the cell (Tisa and Adler,1994).

Achromobacter sp. presented almost a similar scenario as that of the *Vibrio sp.* In fact CaCl₂ addition apparently improved Pi uptake leading to reduced residual Pi concentration in the medium much less than that of the control. There was a near complete removal of Pi from the medium at all the conc. of CaCl₂ tested, higher than 0.03M CaCl₂, indicating that it might be due to Pi complex formation than due to absolute Pi uptake.

In case of *Achromobacter sp.* the response of polyP to CaCl₂ addition was more prominent and significant than that of the *Vibrio sp.* While peaks and falls of polyP was much more marked during the growth phase, the stationary phase polyP was consistently higher at all the conc. of CaCl₂ compared to that of the control, and the difference between the tests and the control was significantly high.

Additional conc. of CaCl₂ extended exponential and stationary phases of growth in both *Achromobacter sp.* and *Vibrio sp.* Results suggest a promotive role for CaCl₂ on growth and survival of the bacterial strains.

The results strongly indicate the physiological importance of polyP in growth and survival under CaCl_2 stress. PolyP increased with increase in CaCl_2 concentration even when the free Pi available in the medium was reduced very significantly with increase of CaCl_2 in the medium. At the 0.09M CaCl_2 the Pi available initially was only $1/30^{\text{th}}$ of that of the control, Nevertheless, polyP was double fold at all conc. of CaCl_2 tested compared to that of the control during most of the growth cycle.

Addition of MgSO_4 to the growth medium led to an increase in the initial Pi concentration of the medium uniformly in the order of the levels of MgSO_4 added. The presence of excess conc. of MgSO_4 , led to a significant inhibition on Pi uptake during the 1 hr. while in the control medium there was rapid uptake of Pi. Nevertheless, there was a slow and uniform Pi uptake till the end of the stationary phase. Further, there was a significant slow down in the rate of Pi uptake on addition of MgSO_4 , and on extended contact time was needed for the complete Pi removal.

Pi uptake in *Achromobacter sp.* was very significantly inhibited by additional MgSO_4 in the medium, at all the conc. of MgSO_4 tested. There was release of Pi during the 1 hr. at all the conc. of MgSO_4 , unlike that of the control in which Pi uptake was significant during the first hour. After the first hour of the lag phase there was slow Pi uptake during the exponential growth. There was enhanced Pi uptake towards the end of the exponential phase, which was followed by an equal release during the early stationary phase. It was also observed that higher the MgSO_4 conc., higher the residual Pi in the medium, similar to that in *Vibrio sp.*

Results obtained in the present study indicated that MgSO_4 when added in excess to the medium probably played the role of a moderator than an inhibitor for Pi uptake and consequently there was neither over shooting of Pi uptake nor Pi release, in the case of *Vibrio sp.* Pi uptake was significantly inhibited by the addition of excess MgSO_4 into the medium and Pi removal decreased as the conc. of MgSO_4 increased, in case of *Achromobacter sp.* Irrespective of the conc. of MgSO_4 , the *Vibrio Sp* tolerated well the inhibitory effect of MgSO_4 on Pi uptake and effected Pi removal close to that of the control. While the *Achromobacter sp* could uptake Pi more than 25%, even at the lowest MgSO_4 conc. and after 48 hrs, in the control medium almost 82% of Pi was removed from the medium. These observations suggest involvement of polyP in Pi uptake and storage preventing Pi release under the presence of excess MgSO_4 stress, observed in *Vibrio sp.* and not in the *Achromobacter sp.*

Probably in response to reduced Pi uptake in the presence of excess MgSO_4 , both *Vibrio* sp and *Achromobacter* sp. showed lesser levels of polyP. The difference was more marked in *Achromobacter* sp than in the *Vibrio* sp.

Addition of sodium citrate to cultivation medium reduced the initial free Pi concentration in the medium. The Pi uptake pattern in *Vibrio* sp. was very characteristic in that the addition of sodium citrate produced a proportional lag in Pi removal such that higher the sodium citrate added, longer was the time taken for the complete removal of Pi from the medium. Moreover, it was preceded by intervals of Pi uptake and release. However, there was complete Pi uptake invariably at all the conc. of sodium citrate tested, except for the delay in the uptake. PolyP levels at all the conc. of sodium citrate tested were significantly lower than that of the control till 36 hrs, when the polyP increased more than the control.

In the case of *Achromobacter* sp. at all the tested conc. of sodium citrate there was a phase of mobilization of Pi, from the phosphate complexes, during the lag phase, leading to an increase in the Pi concentration in the medium almost equal to that of the initial Pi concentration of the control, by 4 hrs., This was followed by phases of Pi uptake and release at all the conc. of sodium citrate tested, till 48 hrs.

Addition of sodium citrate into the medium led to tremendous changes in polyP in *Achromobacter* sp. There was significant increase in the polyP at all the conc. of sodium citrate tested, except at 0.04M which was lower than that of the control during most of the growth cycle. The highest polyP accumulated by the *Achromobacter* sp. at 36 hrs when grown at 0.01M sodium citrate, was almost at par with the polyP accumulation of the *Vibrio* sp.

Addition of sodium citrate into the medium delayed Pi uptake in the *Vibrio* sp. While in *Achromobacter* sp addition of 0.01M sodium citrate led to Pi uptake almost at par with that of *Vibrio* sp, 0.02M caused significant increase in Pi uptake compared to the control. Sodium citrate of 0.04M or more led to reduction in Pi removal in *Achromobacter* sp. The maximum rapid and the complete removal of Pi from the medium was observed during 28-48 hrs in both *Vibrio* sp. and *Achromobacter* sp., during 28-48 hrs.

With increase in sodium citrate in the medium there was decrease in polyP of *Vibrio* sp except during the exponential phase when it increased at all the conc. of sodium citrate tested compared to that of control. There were significant reductions in polyP as well as reduction in the

rate of Pi uptake in all the test conditions compared to the control. In *Achromobacter* sp there was significant increase in polyP on addition of sodium citrate up to 0.03M.

Addition of ammonium nitrate into the medium caused a decrease in the initial levels of free Pi in the medium, probably due to the formation of ammonium phosphate complex (Thomas and Anke, 1997). At all the conc. of ammonium nitrate tested, there was an initial increase of Pi in the medium, possibly due to the mobilization of Pi from the phosphate complexes during the 1st hour of growth by *Vibrio* sp. which was followed by rapid Pi uptake. After 8 hrs there were phases of Pi uptake and Pi release till 28 hrs followed by a rapid Pi removal as in the control. *Vibrio* sp. recorded significant reduction in polyP accumulation at all the conc. of ammonium nitrate during most of the growth cycle, as a result of the reduced Pi uptake. However, during the late stationary phase accelerated Pi uptake resulted in higher polyP accumulation.

In *Achromobacter* sp., an almost similar pattern of Pi uptake as that of *Vibrio* sp was recorded. However, the Pi release was more marked than in *Vibrio* sp. Although there were accelerated Pi uptake during the exponential growth phase and stationary phase, Pi removal during later period was significantly reduced compared to that in the control. Further, at all the conc. of ammonium nitrate there was significant increase in polyP during most of the growth cycle with very prominent peaks of polyP during the lag phase and the stationary phase. In general, at all the conc. of ammonium nitrate tested *Vibrio* sp showed marked reduction in polyP while the *Achromobacter* sp showed consistent increase.

Vibrio sp when grown with additional peptone, as additional carbon source, recorded significant and proportionate reduction in the rate of Pi uptake till the stationary phase (12 hrs.) at all the conc. tested. *Vibrio* sp recorded enhanced Pi uptake at all the tested conc. of peptone during late exponential and stationary phases.

When *Vibrio* sp. was grown with additional peptone, there were no significant difference in polyP level during the exponential phase while there was very significant increase in polyP during the stationary phase. The stationary phase polyP peaks were closely associated with the accelerated Pi uptake and the late exponential growth of the period. Increase in peptone concentration above 2% markedly increased the polyP concentration of *Vibrio* sp. during the stationary phase along with accelerated Pi uptake during the late exponential growth indicating a probable physiological role of polyP in accelerated Pi uptake and the growth.

Unlike *Vibrio sp.*, *Achromobacter sp.* showed a proportionate and consistent reduction in Pi uptake and there was significant lag in Pi removal throughout the growth cycle compared to the control. However, there was significant Pi uptake during the stationary phase

At all the tested conc. of peptone *Achromobacter sp* recorded lesser polyP during the exponential phase, and higher level of polyP during the stationary phase. Unlike *Vibrio*, addition of peptone into the medium above 1% level significantly reduced Pi uptake rate and Pi removal by the *Achromobacter sp.*

Excess levels of yeast extract led to increase in initial phosphate concentration of the medium and probably contained both free inorganic phosphate and some form of phosphate complex. The latter increase in Pi concentration was probably due to the alkaline phosphatase activity (Wanner,1996), contributing to the release of free Pi from the phosphate complexes, and this release was more marked with *Vibrio sp.* compared to *Achromobacter sp.* reinforcing the role of polyP in induction of stress protein expression like alkaline phosphatase (Wanner,1996). At all the tested conc. of yeast extract both the strains showed increase in Pi concentration during the log phase (0-4 hrs) followed by active phosphate removal during the logarithmic growth. However, Pi removal was rather incomplete and significantly lower at all the tested conc. of yeast extract with *Achromobacter sp.* unlike *Vibrio sp.*, where the Pi removal was almost complete. This observation suggest possible interference of phosphate complex formations resulting in incomplete Pi uptake by *Achromobacter sp.*

Addition of yeast extract resulted in very significant increase in polyphosphate concentration in both *Vibrio sp* and *Achromobacter sp*. The impact was more marked, consistent and quantitatively proportionate in the case of *Achromobacter sp.* Both strains exhibited maximal polyP content during the stationary phase, and recorded consistently higher polyP accumulation over that of the control. In case of *Vibrio sp.* significant increase in polyP was observed only at higher levels of yeast extract

From the results obtained in the present study, it was inferred that glucose as additional carbon source was rather inhibitory in nature for the growth of *Vibrio sp* and *Achromobacter sp* even at 0.05M conc., besides inhibitory to Pi uptake process. In *Vibrio sp.* the inhibition was proportionate to the increase in the glucose concentration, with the lowest Pi removal at highest glucose level.

The level of inhibition for Pi uptake was higher during exponential phase. During the later part of the stationary phase the Pi uptake resumed and was at similar levels recorded with the control medium. Probably this might have occurred once the depletion of glucose from the medium took place by 28-36 hrs. Results suggest that the inhibition is less likely to be a competitive mechanism, because addition of excess Pi at constant glucose concentration did not improve Pi uptake. Probably there exist two different Pi uptake mechanisms in these bacteria, where the exponential phase Pi uptake mechanism appeared to be glucose sensitive, while the stationary phase specific Pi transport system was not sensitive to glucose, when it was not due to depletion of glucose in the medium.

At all the tested conc. of glucose *Vibrio sp.* recorded marked reduction in polyP accumulation along with the reduction in Pi uptake during the exponential phase. During the stationary phase there was exhaustion of glucose, enhanced Pi uptake along with polyP increase. The results suggest possible turnover of polyP during the utilization of glucose.

Achromobacter sp. also recorded, at all the glucose conc. tested, lesser polyP accumulation during the exponential phase followed by a linear increase of polyP during the stationary phase along with the significant release of glucose into the medium

The *Vibrio sp.* depleted added glucose from the medium completely before the end of 48 hrs in all the tested levels except 0.2M, while the *Achromobacter sp.* showed significantly consistent increase of glucose concentration in the medium indicating marked release of glucose into the medium. The glucose release was more marked during the stationary phase and it commenced early when Pi concentration of the medium was increased.

There was an inverse relation between glucose concentration and Pi uptake as well as polyP accumulation. All the glucose test growths showed very significant and proportional reduction in Pi uptake and polyP accumulation with increase in glucose concentration in the medium. However, the proportion of the Pi conversion to polyP is higher than the control in all the tests, except in 0.2M glucose, indicating that the inhibitory effect of glucose might be on Pi uptake than on polyP formation.

Since reports on similar nature of work concerned with marine bacteria are not available it has become very difficult to draw any direct comparison with other marine bacteria. This entire work presented in the thesis is the first of it's kind to the best of our knowledge and hence detailed studies are required to understand the impact of various parameters observed during the course of study

5. SUMMARY & CONCLUSION

Bacteria having potential for rapid Pi uptake and polyphosphate accumulation were isolated from seawater and marine sediment samples collected from coastal environments of Kerala and Tamil nadu. 540 isolates were obtained from seawater (340) and marine sediment (200). All the isolates were evaluated for their efficiency to uptake inorganic phosphate from the medium and accumulate Pi as polyphosphate (polyP). The lowest Pi uptake recorded was 86% against the maximum of 97.8%, after 24 hrs. of incubation.

Among the 540 isolates, more than 95% of the isolates recorded cellular free Pi at concentrations in the range of 120-250 μ M, and accumulated polyP up to >35 μ g/mg cell protein in their cells. Relatively, isolates obtained from seawater were capable of accumulating enhanced levels of polyP compared to that of marine sediments.

26 isolates were short listed based on their efficiency to uptake phosphate from the medium and release them into environment besides accumulating polyP in the cells, evaluated during the preliminary screening conducted as under first phase. They mainly included species of *Pseudomonas*, *Vibrio*, *Acinetobacter*, *Enterobacteriaceae*, *Achromobacter*, *Arthrobacter* and *Staphylococci*

All the 26 isolates were subjected to further screening which included evaluation of their efficiency to accumulate Biomass, Pi uptake, cellular free Pi, Low molecular weight phosphate, polyphosphate, and nucleic acid phosphates.

In general all the 26 isolates, irrespective of their source and affiliation to different genera, indicated that their logarithmic phase of growth was during 4-8 hrs. However, maximal biomass was recorded after 24 hrs. for the species of *Vibrio*, *Staphylococci*, *Acinetobacter* and the *Enterobacteriaceae* sp isolated from the marine sediment, while species of *Pseudomonas*, *Arthrobacter* and *Enterobacteriaceae* isolated from the sea water recorded maximal biomass after 40 hrs.

All the isolates could effect almost >60% of Pi removal except *Achromobacter* Sp. which recorded only 57.03% Pi removal. In fact 4 -8 hrs. was observed as logarithmic phase and there was Pi release into the medium resulting in a decline in % Pi removal . However, later, there was

steady increase in the rate of % of Pi removal during the stationary phase of growth for all the isolates

All the isolates tested could record considerable level of Pi as cellular free Pi fraction during growth. Irrespective of the source, all the isolates tested invariably showed fluctuation, in terms of decrease and increase alternatively, in the level of Low molecular weight phosphates in the cells during the course of growth. Nevertheless, all the isolates irrespective of their affiliation, recorded a rapid decline in the phosphate level during logarithmic phase of growth (4-8 hrs.) followed by a raise in phosphate level at 16 hrs.

None of the isolates accumulated any detectable level of polyphosphate during the first hour of growth. Polyphosphate accumulation was recorded from 2nd hour onwards which reached a maximum at 4 hrs. for all the isolates, except for the species of *Arthrobacter*, *Achromobacter* and *Pseudomonas* for which maximal polyP was recorded, respectively, at 2hrs., 24 hrs. and 40 hrs. An interesting observation made during the study was that, all the isolates spent their polyphosphate during active logarithmic phase. However, at 24 hrs all the isolates showed considerable increase in polyphosphate levels, which declined later at 40 hrs., except in *Pseudomonas* sp. PolyP levels in the cells during the stationary phase, after 24 hrs – 7 days were very low when compared to the exponential phase.

Maximal levels of nucleic acid phosphates were recorded during early phase of growth (Logarithmic phase – 2-4 hrs) for the isolates. While species of *Vibrio*, *Arthrobacter* and *Staphylococci* obtained from sea water recorded their maximal nucleic acid phosphates at 2 hrs., species of *Vibrio*, *Enterobacteriaceae*, *Pseudomonas*, *Acinetobacter* and *Achromobacter* isolated from marine sediment, recorded their maximum at 4 hrs. Further, all the isolates recorded considerable decrease in their nucleic acid phosphate levels at 8 hrs. Later period of growth witnessed rise and fall, in the levels of Pi indicating wide fluctuation.

Based on the efficiency to effect maximal Pi uptake and release and polyP accumulation, the *Vibrio* sp. BTDW128 and *Achromobacter* BTDS 64 were selected to study the impact of the environmental factors on Pi uptake and release, and polyP accumulation.

Impact of varying concentration of phosphate, in addition to the phosphate already available in the Zobell's marine broth, on the rate of phosphate uptake and polyP accumulation by marine bacteria was studied using KH_2PO_4 as source of phosphate. At all the conc. of Pi tested,

Vibrio sp. , recorded rapid uptake of Pi during the first hour of growth itself and the rate of Pi removal was proportionately high along with the increase in the initial conc. of Pi in the medium. Further, at all initial Pi conc. tested there was complete removal of Pi from the medium during later hours of growth, after 20 hrs. *Achromobacter* sp. could rapidly uptake Pi during the first hour of growth, during lag phase and the rate of Pi uptake increased along with increase in initial conc. of Pi in the medium. The maximal uptake was about 80% in the control while only 40-60% in Pi added growth. Rapid accumulation of polyP took place during 1-4 hrs at all the conc. of initial Pi and in the control medium, except at 500 μ M Pi, where the rate of polyP accumulation was relatively less. . In general even the highest polyP conc. attained by the *Achromobacter* sp. was only $\frac{1}{4}$ of that of the *Vibrio* sp. despite the increase of Pi in the medium. Pi uptake and PolyP accumulation had a positive relation of concomitant increase during 1-4 hrs. at all the Pi conc. tested, except at 9000 μ M and 3000 μ M when the polyP increased along with decrease in Pi uptake.

Both *Vibrio* sp. and *Achromobacter* sp were unaffected by alterations in the pH range of 6-10, although at alkaline pH the actual Pi uptake could not be estimated by chemical method because of the phosphate complex formation and release in the medium.

Variation in incubation temperature did not influence significantly the rate of phosphate uptake by *Vibrio* sp. which recorded, at all the temperatures tested, significant reduction in the rate of Pi uptake. Though there were no significant differences in Pi uptake for the temperatures tested, there was significant reduction in Pi uptake at 55 $^{\circ}$ C. Although increase in temperature retarded the rate of Pi removal by the *Vibrio* sp. finally the rate of Pi removal revived back at all temperatures ranging from 30 to 55 $^{\circ}$ C. Unlike *Vibrio* sp, in *Achromobacter* sp, Pi uptake increased with increase in temperature Increase in temperature led to proportionate increase in the rate and efficiency of Pi removal by *Achromobacter* sp. PolyP increased almost proportionately with the increase in temperature. Maximal polyP was recorded at 55 $^{\circ}$ C.

Despite the high saline stress both *Vibrio* sp. and *Achromobacter* sp. strains proved to be high salt tolerant with appreciable growth and survival, maintaining a biomass equitable to that of control throughout the growth cycle. The rate of Pi uptake was slow in test conditions compared to the control. The Pi uptake patterns and efficiencies of the high polyP *Vibrio* sp. and low polyP *Achromobacter* sp., suggest that Pi transport systems are influenced by sodium chloride conc. drastically in *Achromobacter* sp unlike *Vibrio* sp, In the *Vibrio*,sp. as the NaCl concentration increased there was progressive reduction in Pi uptake and polyP. In *Achromobacter* sp also there

was enhanced conversion of a significantly greater proportion of the Pi into polyP, which reached as high as 76% of the Pi uptake at 0.7M NaCl.

Both *Vibrio sp.* and *Achromobacter sp.* were found to tolerate additional conc. of KCl in the medium. The results indicated that additional KCl in the medium accelerated the early Pi uptake. In *Vibrio sp.* polyP level remained significantly lesser in the presence of excess conc. of KCl compared to that of the control. There were no significant differences in the polyP levels in response to varying KCl conc.. *Achromobacter sp.* showed marked increase in polyP invariably at all the test conditions compared to the control. Despite the significant reduction in the overall Pi removal from the medium the *Achromobacter sp.* showed a significant increase in growth and polyP accumulation in the presence of added KCl especially in the 0.014-0.021 M range. The effective maximal Pi uptake and polyP were significantly low at all the tested conc. of KCl compared to the control. In *Achromobacter sp.* although the effective Pi removal was significantly reduced by excess KCl in the medium, there was a significant increase in polyP.

CaCl₂ addition apparently improved Pi uptake leading to reduced residual Pi concentration in the medium much less than that of the control. There was a near complete removal of Pi from the medium at all the conc. of CaCl₂ tested, higher than 0.03M CaCl₂. Additional conc. of CaCl₂ extended exponential and stationary phases of growth in both *Achromobacter sp.* and *Vibrio sp.* PolyP increased with increase in CaCl₂ concentration even when the free Pi available in the medium was reduced very significantly with increase of CaCl₂ in the medium. PolyP was double fold at all conc. of CaCl₂ tested compared to that of the control during most of the growth cycle. The presence of excess conc. of MgSO₄, led to a significant inhibition on Pi uptake during the 1 hr. while in the control medium there was rapid uptake of Pi. Nevertheless, there was a slow and uniform Pi uptake till the end of the stationary phase. Pi uptake in *Achromobacter sp.* was very significantly inhibited by additional MgSO₄ in the medium, at all the conc. of MgSO₄ tested.

MgSO₄ when added in excess to the medium probably played the role of a moderator than an inhibitor for Pi uptake and consequently there was neither over shooting of Pi uptake nor Pi release, in the case of *Vibrio sp.* Pi uptake was significantly inhibited by the addition of excess MgSO₄ into the medium and Pi removal decreased as the conc. of MgSO₄ increased, in case of *Achromobacter sp.*

The Pi uptake pattern in *Vibrio sp.* was very characteristic in that the addition of sodium citrate produced a proportional lag in Pi removal such that higher the sodium citrate added, longer

was the time taken for the complete removal of Pi from the medium. PolyP levels at all the conc. of sodium citrate tested were significantly lower than that of the control till 36 hrs, when the polyP increased more than the control. Addition of sodium citrate into the medium led to tremendous changes in polyP in *Achromobacter* sp. Addition of sodium citrate into the medium delayed Pi uptake in the *Vibrio* sp. With increase in sodium citrate in the medium there was decrease in polyP of *Vibrio* sp except during the exponential phase when it increased at all the conc. of sodium citrate tested compared to that of control.

At all the conc. of ammonium nitrate tested, there was an initial increase of Pi in the medium, possibly due to the mobilization of Pi from the phosphate complexes during the 1st hour of growth by *Vibrio* sp. which was followed by rapid Pi uptake.. *Vibrio* sp. recorded significant reduction in polyP accumulation at all the conc. of ammonium nitrate during most of the growth cycle,. In *Achromobacter* sp, at all the conc. of ammonium nitrate there was significant increase in polyP during most of the growth cycle with very prominent peaks of polyP during the lag phase and the stationary phase. In general, at all the conc. of ammonium nitrate tested *Vibrio* sp showed marked reduction in polyP while the *Achromobacter* sp showed consistent increase.

Vibrio sp when grown with additional peptone, as additional carbon source recorded significant and proportionate reduction in the rate of Pi uptake till the stationary phase (12 hrs.) at all the conc. tested. Further, there were no significant difference in polyP level during the exponential phase while there was very significant increase in polyP during the stationary phase., *Achromobacter* sp. showed a proportionate and consistent reduction in Pi uptake and there was significant lag in Pi removal throughout the growth cycle compared to the control. At all the tested conc. of peptone *Achromobacter* sp recorded lesser polyP during the exponential phase, and higher level of polyP during the stationary phase. Unlike *Vibrio*, addition of peptone into the medium above 1% level significantly reduced Pi uptake rate and Pi removal by the *Achromobacter* sp.

At all the tested conc. of yeast extract both the strains showed increase in Pi concentration during the log phase (0-4 hrs) followed by active phosphate removal during the logarithmic growth. Addition of yeast extract resulted in very significant increase in polyphosphate concentration in both *Vibrio* sp and *Achromobacter* sp. Both strains exhibited maximal polyP content during the stationary phase, and recorded consistently higher polyP accumulation over that of the control. In case of *Vibrio* sp. significant increase in polyP was observed only at higher levels of yeast extract

There was an inverse relation between glucose concentration and Pi uptake as well as polyP accumulation. At all the glucose conc. very significant and proportional reduction in Pi uptake and polyP accumulation with increase in glucose concentration in the medium was recorded for both the strains.

The two strains finally selected and studied are very interesting in their efficiencies for Pi removal and polyP accumulation. They have contrasting characters. The *Vibrio sp.* Has (1) unlimited capacity to uptake Pi, (2) accumulates very significant amount of polyP (3) has remarkable tolerance for salt, pH and temperature, (4) and rapidly assimilates of glucose. While the *Achromobacter sp.* has (1) limited Pi uptake capacity and (2) lower polyP, (3) it was found to be defective in glucose uptake. More over, it was leaking glucose into the medium especially during the stationary phase (while *Vibrio sp.* absorbed majority of the glucose), and further increase in Pi in the medium responded with early glucose release even during the 1hr.

Possible relation or interaction between polyP accumulation phenomenon, the low biomass, low Pi uptake, and varying results obtained in response to the impact of sodium chloride, pH, temperature, various inorganic salts and additional carbon sources studied, are all intriguing observations made in the present investigation. In fact a detailed study at the molecular level with specific reference to Pi transport mechanisms involved, and the role of polyphosphate kinase (ppk) is warranted to have a clear understanding about the behavior of marine bacteria, in comparison to activated sludge bacteria which have been already studied to some extent..

In conclusion, it is important to recognise the immense potential of marine bacteria which remains untapped in terms of economic utilization by any developing society. Results of the present study have evidenced very clearly the scope for potential strains of bacteria from both sea water and marine sediments which could be exploited both for Pi removal in waste water released by industries and intensive aquaculture practices in to the aquatic environment as well as to harness the potential strains for industrial production of polyP which has wide range of applications.

REFERENCES

1. Ahn, K. and Kornberg, A., (1990). Polyphosphate Kinase from *E-coli* J. Biol Chem. 265: 11734-11739.
2. Akiyama, M., Crooke, E. and Kornberg, A. (1993) An Exopolyphosphatase of *E.coli*. The enzymes and its *ppx* gene in polyphosphate operon. J. Biol. Chem. 268, 633-639.
3. Akiyama, M., Crooke, E. and Kornberg, A. (1992). The *ppk* gene of *E.coli*. J. Biol. Chem. 267 : 2255-2261.
4. Archibald, F.S., I. Fridovich (1982). Investigations of the state of the manganese in *Lactobacillus plantarum* Arch. Biochem. Biophys. 215: 589-596.
5. Avaeva, S.M.,N.N.Vorobyeva,S.A. Kurilova, T.I.Nazarova, K.M. Polyakov,E.V.Rodina andV.R.Samygina (2000). Mechanism of calcium induced inhibition of *E.coli* inorganic pyrophosphatase. Biochem.(Moscow), 65, 3
6. Ault – Riche, D., Fraley, C.D., Tzeng, C.M., Kornberg A. (1998) J. bacteriol 180, 1841-47.
7. Bayer, M.E.,(1968) Areas of Adhesion between cell wall and membrane of *E.coli*, J. Gen. Microbiol. 53: 395-404.
8. Belozersky, A.N. (1958) The formation and functions of polyphosphates in the developmental processes of some lower organisms. Comm and Reports to the fourth Intern. Biochem. Congress, Vienna.
9. Bonting, C.F.C., G.J.J Kortstee, and A.J.B Zehnder, (1991) Properties of polyphosphate : AMP phosphotransferase of *Acinetobacter* strain 210A. J. Bacteriol. 173 : 6484- 6488.
10. Butler, L. (1977) A suggested approach to ATP regeneration for enzyme technology applications. Biotechnol. Bio eng. 19: 591-593.
11. Cemeau . Y, Hall, K.J, Hancock, R. E.W., Oldham W.K. (1986). Biochemical model for enhanced biological phosphorus removal. Water Res., 20, 511-521.
12. Chandrasekaran, M.(1998). Molecular cloning of *ppk* gene of *Pseudomonas putida* HAS 29 isolated from activated sludge. Repoert of over seas associateship of DBT, Ministry of Science and Technology, Govt.of India.

13. Crooke, E., Akiyama, M., Rao, N.N. and Kornberg A. (1994) Genetically altered levels of inorganic polyP in E-coli, J. Biol. Chem. 269: 6290-6295.
14. Davelaar, D., Davies, T.R., Wiechers, S.G. (1978). Wat. Sth Afr. 4, 54-59.
15. Davies DD (1973). Metabolic control in higher plants In: Milborrow BV (ed) biosynthesis and its control in plants. Academic press, London, pp 1-20.
16. Dunn, T., K. Gable, and T. Beeler. (1994). Regulation of cellular Ca²⁺ by yeast vacuoles. J. Biol. Chem. 269: 7273-7278.
17. Ebel, J.P. (1948) Sur le dosage des metaphosphates dans les microorganismes par hydrolyse differentielle technique et application aux levures. C.R. Acad. Sci. 226: 2184-2186.
18. Elvin, C.E., Dixon, N.E. and Rosenberg, H. (1986) Molecular cloning of Pi inorganic transport (Pit) gene of *E.coli* K-12: identification of the pit gene product and physical mapping of the pit region, Mol. Gen. Genet. 204, 477-84.
19. Fuhs, G.W. and Chen, M, (1975) Microbial basis of Pi removal in the activated sludge process for the treatment of waste water. Microbial Ecology, 2:119-138.
20. Gabel, N.W., and V. Thomas, (1971): Evidence for the occurrence and distribution of inorganic polyphosphate in vertebrate tissues. J. Neurochem. 18: 1229-1242.
21. Geissdorfer, W., Frosch, S.C. Haspel, G., Ehrt, S. and Hillen, W. (1995): Two genes encoding proteins with similarities to rubredoxin and rubredoxin reductase are required for conversion of dodecane to lauric acid in *Acinetobacter calcoaceticus*, Microbiol. 141, 1425-1432.
22. Griffith, E.J., (1992) In search of a safe mineral fibre. Chemtech, 22: 220-226.
23. Hager A, Berthold W, Biber W, Edel H-G, Lanz C, Schiebel G (1986). Primary and secondary energized ion translocating systems on membranes of plant cells. Ber Dtsch Bot Ges 99: 281-295.
24. Hammond, A.E. (1971), Phosphate replacements: Problems with the washday miracles. Science, 172: 361-364.
25. Harada, K., and S. Fox. (1965). Thermal poly condensation of free amino acids with polyphosphoric acid, P- 289-298. In: S. Fox (ed). Origins of pre-biological systems. Academic Press, Inc. New York.
26. Hardoyo, K. Yamada, H. Shinjo, J. Kato and H. Ohtake (1994). Production and release of polyP by a genetically engineered strain of E-coli Appl. Environ. Microbiol., 90: 3485-3490.

27. Harley JL, Brierly J.K., Mc Cready CC (1954). The uptake of phosphate by excised mycorrhizal roots of the beech. V. The examination of possible sources of misinterpretation of the quantities of phosphorus passing into the host. *New phytol.* 53: 92-98.
28. Harold F.M. (1963) Accumulation of inorganic polyP in *Aerobacter aerogenes*-relationship to growth and nucleic acid synthesis. *J. Bacteriol* 86, 216-221.
29. Harold, F.M (1966). Inorganic polyphosphates in biology: structure, metabolism, and function. *Bacteriol Rev.* 30: 772-794.
30. Harris, R.S., S. Longrich, and S.M. Rosenberg, (1994). Recombination in adaptive mutation, *Science* 264: 258-260.
31. Healey, F.P. (1982). Phosphate. In: *The biology of cyanobacteria*, Carr, N.G. and Whitton, B.A. eds. Pp. 105-124, Oxford: Black well Science Publications.
32. Herbert, D., Phipps, P.J., Strange, P.E. (1971). Chemical analysis of microbial cells. In: *Methods in Microbiology*, Vol. VB, pp 249-344.
33. Higgins, C.F (1992) ABC transporters: From microorganisms to man, *Ann Rev. Cell Biol.* 8, 67-113.
34. Hiroaki Sudo, Akiyo Yamada, Noriyuki Nakamura and Tadashi Matsunaga (1997). Phosphorus accumulation by a marine photosynthetic bacterium, *Chromatium sp.* *Biotech. Letters*, 19: 8 :783-786.
35. Hsieh, P.C, B.C Shenoy, J.E. Jentoft, and N.F.B Philips, (1993). Purification of polyP and ATP glucose phosphotransferase from *Mycobacterium tuberculosis* H₃₇Ra: Evidence that polyP (P) and ATP glucokinase activities are catalyzed by the same enzyme. *Protein Exp. Purif.* 4: 76-84.
36. Kato, J., Yamada, K., Muranatsu, A., Hardoyo, and Ohtake, H. (1993,a) Genetic improvement of *E.coli* for enhanced biological removal of phosphate *Appl. Environ. Microbiol* 59, 3744-3749.
37. Kato, J., Yamato, T., Yamada, K. and Ohtake, H., (1993,b) cloning, sequence and characterization of polyP Kinase Encoding gene of *Klebsiella aerobenes*. *Gene*, 137:237-242.
38. Keasling, J.D., S.J. VanDien, P. Trelstad, et.al, (2000) Application of Polyphosphate Metabolism to Environmental and Biotechnological problems. *Biochem (Moscow)* 65, No.3.
39. Komberg A. (2000) Tribute to Professor Igor S. Kulaev. *Biochem. (Moscow)* 65, 3

40. Kornberg A. (1995) Inorganic polyphosphate : Towards making a forgotten polymer unforgettable. *J. Bacteriol.* 177: No.3, 491-496.
41. Kornberg, A. (1957). Pyrophosphorylases and phosphorylases in biosynthetic reactions. *Adv. Enzymol* 18: 191-240.
42. Kornberg, A., Sylvykornberg and E. Simms (1956). Metaphosphate synthesis by an enzyme from *E.coli*, *Biochim. Biophys. Acta* 20: 215-227.
43. Kulaev I.S., (1975). Biochemistry of inorganic polyphosphates. *Rev. Physiol. Biochem. Pharmacol.* 73: 131-158.
44. Kulaev I.S., V.M. Vagabov, and Y.A. Shabalin (1987). New data on biosynthesis of polyP in yeast, P. 233-38 In . A. Torriani- Gorini, F.G. Rothman, S. Silver, A. Wright, and E. Yagil (Ed.) *Ph. Metabolism and cellular regulation in microorganisms*. American society for microbiol, Washington, D.C.
45. Kulaev, I.S. (1979). *The biochemistry of inorganic polyP*. John Wiley and Sons, Inc, New York.
46. Kulaev, I.S. and Vagabov, V.M. (1983). Polyphosphate metabolism in microorganisms. In: *Advances in Microbial physiology*. Rose, H.A., Morris, J.G., and Tempest, D.W. eds, pp- 83-171, London : Academic press.
47. Kulaev, I.S., and K.G. Skryabin, (1974). Reactions of non enzymatic transphosphorylation performed by high polymeric polyphosphates and their role in abiogenesis *Zh. Evol. Biokhim – Fiziol.* 10: 533.
48. Kumble, K.D., and A. Kornberg 1995: Inorganic polyP in Mammalian cells and Tissues. *J. Biol. Chem.* 270,11,5818-1822.
49. Kuroda A. and Kornberg A. (1997b) Guanosine tetra and penta phosphate promote accumulation of inorganic polyP in *E.coli*, *J. Biol. Chem.* 272: 21240-21243.
50. Kuroda A. and Ohtake, H, (2000) Molecular analysis of polyphosphate accumulation in bacteria, *Biochem. (Moscow)*, vol. 65 No.3
51. Kuroda A., and Kornberg A. (1997a). *PNAS, USA*, 94, 439-42
52. Kuroda A. Shoutaro Tanaka, Tsukasa Ikeda, Junichikato, Noboru Takiguchi and H. Ohtake(1999); Inorganic PPK is required to stimulate protein degradation and for adaptation to aminoacid starvation in *E. coli*, *PNAS*, Vol. 96, No.25, 14264-14269.
53. Lawson E.N and Tonhazy N.E. (1980). Changes in Morphology and phosphate uptake patterns for *Acinetobacter calcoaceticus* strains, *Wat. SA.* 6, 105-112.

54. Lee, R.M., Hartman, P.A., Stahr, H.M., Olson, D.G. and F.D. Williams. (1994) Antibacterial mechanism of long chain polyphosphate in *Staph. aureus*. J. Food Prot., 57: 289-294.
55. Leyhausen, G., Lorenz, B., Zhu, H., et.al, (1998) J. Bone Miner. Res., 13, 803-812.
56. Lichko, L.P., T.V. Kulakovskaya, And I.S. Kulaev (2000) Purification and Characterization of a soluble polyphosphatase form Mitochondria of *S. cerevisiae*. Biochem (Moscow) Vol. 65, N.3.
57. Liebermann, L. (1888). Uber das Nuclein der irefe und Kunetliche Darstellung eines Nuclein's Eiweiss und Metaphosphorsaure. Ber. Dtsch. Chem. Ges. 21: 598-607.
58. Lohmann K. (1958). Uber das Vorkommen der kondensierten phosphate in Lebewesen P. 29-44. In kondensierte phosphate in Lebensmittein. Springer Verky. Berlin.
59. Martin, F., Marchal J.P., Tyminska A, Canet D(1985). The Metabolism and physical state of polyphosphates in ectomycorrhizal fungi. A ³¹p NMR study. New phytol 101: 275-290.
60. Montgomery D.M., Dean, A.C.R et.al, (1995) Microbiology, 141, 2433-2441.
61. Muyima N.Y.O and Cloete T.E (1995) Growth and Pi uptake of immobilized acinetobacter cells suspended in Activated sludge mixed liquor; water Res. Vol. 29. 11, 2461-2466.
62. Nakamura K., Masuda, K., and Mikani, E., (1991) Isolation of a new type of polyphosphate accumulating bacterium and its phosphate removal characteristics. J. Ferment. Techol., 71 (4), 433-439.
63. Nesmeyanova, M.A. (2000) Polyphosphates and Enzymes of polyphosphate Metabolism in *E.coli.*, Biochem. (MOSCOW), vol.65, N.3.
64. Offenbacher, S., and E.S, Kline. (1984). Evidence for polyP in phosphorylated non-histone nuclear proteins Arch. Biochem. Biophys. 231: 114-123.
65. Ohtake, H., A. Kuroda, M. Chandrasekaran, H. Wu, S. Tanaka, T. Morohoshi, J. Kato, T.Ikeda and N. Takiguchi (1999) Molecular Genetics of bacterial polyP accumulation to better understand the mechanism underlying Biological phosphorus Removal. Michael Healy *et.al* (eds) In- Environmental Monitoring and Biodiagnostics of Hazardous Contaminants, 181-196, Kluwer Academic Publishers.
66. Ohtake, H. K. Takahashi, Y. Tsuzyki and K. Toda, (1985). Uptake and release of phosphate by a pure culture of *Acinetobacter calcoaceticus*, water Res., 19: 1587-1594.

67. Ohtake, H., Wu, H., Imazu, K., Anbe, Y., Kato, J., and A. Kuroda. (1996). Bacterial phosphate degradation, oxidation and polyP accumulation. *Resources, conservation and Recycling* 18: 125-134.
68. Osborn D.W. and Nicholls H.A (1978). Optimization of the activated sludge process for the biological removal of Phosphorus. *Pro. Wat. Technol.* 10, 261-277.
69. Pettersson, A., Kunst, L., et.al, (1985). *J. Gen. Microbiol.*, 131, 2545-2548.
70. Pick, U., and M. Weiss. (1991). PolyP hydrolysis within acidic vacuoles in response to amine – induced alkaline stress in the halotolerant alga, *Dunaliella salina*, *plant physiol.* 97: 1234-1240.
71. Pisoni, R.L., and E.R. Lindley, (1991): Incorporation of ³²P orthophosphate into long chains of inorganic polyP within lysosomes of human fibro blasts. *J. Biol. Chem*, 267, 3626-3631.
72. Rao, N.N., Liu, S. and Kornberg A (1998). *J. Bacteriol* 180: 2186-2193.
73. Rea P.A., Poole R.J., (1986). Chromatographic resolution of H⁺ translocating pyrophosphate from H⁺- translocating ATP ase of higher plants tonoplasts. *Plant physiol.* 81: 126-129.
74. Reusch, R.N and H.L. Sadoff, (1988) Putative structure and functions of a PHB/Ca PolyP channel in bacterial plasma membranes. *Proc. Natl Acad. Sci. USA* 85: 4176-4180.
75. Rodriguez R.J. (1993) Polyphosphate present in DNA preparations from filamentous fungal species of *colletotrichum* inhibits restriction endonucleases and other enzymes. *Anual. Biochem.* 209: 291-297.
76. Roos A, Boron W.F (1981). Intra-cellular pH. *Physiol. Rev.* 61 : 296-434.
77. Serrano, R. (1984). Plasma membrane ATP ase of fungi and plants as a novel type of proton pump. *Curr. Top. Cell. Regul.* 23: 87-126.
78. Shoda, M., Ohsumi T., and Udaka, S. (1980). Screening for high Pi accumulating bacteria. *Agri. Biol. Chem.* 44: 319-324.
79. Siegele, D.A, and R. Kolter. (1992). Life after log. *J. Bacteriol.* 174: 345-348.
80. Thomas G.M. Gerlitz., Anke Gerlitz (1997). Phosphate uptake and polyphosphate metabolism of micorrhizal and non micorrhizal roots of pine and of *suillus bovinus* at varying external pH measured by in vivo ³¹P-NMR; Springer – Verlag 1997, 101-106.
81. Tinsley, C.R, and Gotschlich, E.C.(1995).Cloning and characterization of the meningococcal ppk gene: Production of polyP synthesis mutants, *Infect. Immun.* 63, 1624-1630.

82. Tinsley, C.R., B.N. Manjula, and E.C. Gotschlich, (1993). Purification and characterization of PPK from *N. meningitidis*. *Infect immune*. 61: 3703-3710.
83. Tisa. L.S., and Adler, J. (1994) *PNAS, USA*, 89, 11804-808
84. Toerien, D.F., Gerber, A., Lotter, L.H., and Cloete, T.E. (1990) *adv. Microb, Ecol.*, 11, 173-230.
85. Torimitsu K; Yazaki Y, Nagasuka K, Ohta E, Sakata M, (1984), Effect of external pH on the cytoplasmic and vacuolar pH in mung bean root – tip cells: A ³¹P NMR study. *Plant cell physiology* 25: 1403-1409.
86. Vagabov, V.M., T.V. Trilisenko an I.S. Kuleav (2000) Dependence of inorganic polyphosphate chain length on the orthophosphate content in the culture medium of the yeast *S. cerevisiae*. *Biochem. (MOSCOW)*, 65, N.3.
87. Van Groenestijn, J.W., Vlekke, G.J. F.M., Anink, D.M.E., Deinema, M.H. and Zehnder, A.J. B. (1988). *Appl. Environ. Microbiol.* 54, 2894-2901.
88. Vieira J. and Messing. (1987). Production of single stranded plasmid DNA. *Methods Enzymol.*, 153: 3-11.
89. Waehneltd, T.V, and S. Fox (1967). Phosphorylation of nucleosides with polyphosphoric acid, *Biochem. Biophys Acta* 134: 9-16.
90. Wanner, B.L. (1996). Phosphorous assimilation and control of the phosphate regulon in *E-coli* and *S. typhi*: Cellular and Molecular biology, F.C.Neidhart,R.Curtiss III,J.L.Ingraham,E.C.C.Lin,K.B.Low,B.Megasanik,W.S.Reznikkoff,M.Riley,M.Schaeter and H.E.Umbarger(ed.) Washington,D.C.,American society for Microbiology, 2nd ed. P 1357-1381
91. Wiame, J.M. (1947). Etude d'une substance polyphosphoree basophile et metachromatique chez les levures *Biochim. Biophys. Acta.* 1:234-255.
92. Winkler, M.E. (1996) In *E.coli and Salmonella : Cellular and molecular biology*, eds, Neidhardt, F.C., Curtiss, R. III. Ingraham, J.L. *et.al*, Am. Soc. Microbiol, Washington, D.C. pp 485-505.
93. Wood, H.G., (1985). Inorganic pyrophosphate and polyphosphates as sources of energy. *Curr. Top. Cell. Reg.* 26: 355-369.
94. Wood, H.G., J.E. Clark (1988). Biological aspects of Inorganic PolyP. *Annu Rev. Biochem.* 57 : 235- 260.
95. Wurst, H., and Kornberg, A. (1994). A soluble expolyphosphatase of *Saccharomyces cerevisiae*. *J. Biol. Chem.* 269: 10996-11001.

96. Yamagata, Y., H. Wantanae, M. Saitoh, and T. Namba (1991). Volcanic production of polyphosphates and its relevance to prebiotic evolution. *Nature*: 352: 516-519.
97. Yen, C., Green, L. and Miller C.G., (1980). *J. Mol. Biol.* 143, 21-23.

678892